

Weather Station

models 02050CAUDI / 02051CAUDI



CONTENTS

Unpacking Instructions	2	Placement Guidelines	8
Package Contents	2	Using the Weather Station	9
Features & Benefits: Sensor	2	Troubleshooting	10
Features & Benefits: Display	3	Care & Maintenance	11
Setup	5	Calibration	12
Sensor Setup	5	Replace Intelli-Time Battery	13
Display Setup	6	Specifications	14
Intelli-Time Clock	7	FCC Information	14
Set the Time, Date & Units	7	Customer Support	15
Backlight Settings	7		

Questions? Contact Customer Support at (877) 221-1252 or visit www.AcuRite.com.

SAVE THIS MANUAL FOR FUTURE REFERENCE.

ACURITE®

Congratulations on your new AcuRite product. To ensure the best possible product performance, please read this manual in its entirety and retain it for future reference.

Unpacking Instructions

Remove the protective film that is applied to the LCD screen prior to using this product. Locate the tab and peel off to remove.

Package Contents

1. Display unit with tabletop stand
2. Outdoor sensor
3. Instruction Manual
4. Power adapter

Features & Benefits



OUTDOOR SENSOR

- 1. Integrated Hanger**
For easy placement.
- 2. Wireless Signal Indicator**
Flashes when data is being sent to the display unit.
- 3. Battery Compartment**
- 4. A-B-C Switch**
ID code that must match display's A-B-C switch to ensure units synchronize.
- 5. Battery Compartment Cover**

Features & Benefits



DISPLAY UNIT FRONT

- 1. Current Outdoor Temperature**
Arrow icon indicates the direction temperature is trending.
- 2. Outdoor Sensor Signal Strength**
- 3. HIGH Indicator**
Indicates today's HIGH records are being viewed.
- 4. LOW Indicator**
Indicates today's LOW records are being viewed.
- 5. Sensor Low Battery Indicator**
- 6. Current Outdoor Humidity**
Arrow icon indicates the direction humidity is trending.
- 7. Current Indoor Humidity**
- 8. Current Indoor Temperature**
- 9. Moon Phase**
- 10.  AUTO DIM Icon**
Indicates display backlight "AUTO DIM" mode activated.
- 11. Display Low Battery Indicator**
- 12. Removable Tabletop Stand**
- 13. Date**
- 14. Time**
- 15. Current Barometric Pressure**
Arrow icon indicates the direction pressure is trending.
- 16. Learning Mode Icon**
Disappears after weather forecast self-calibration is complete.
- 17. 12 to 24 Hour Weather Forecast**
Self-Calibrating Forecasting pulls data from the outdoor sensor to generate your personal forecast.
- 18. Momentary Backlight Button**
Momentarily lights display (only applicable while on battery power).

Features & Benefits

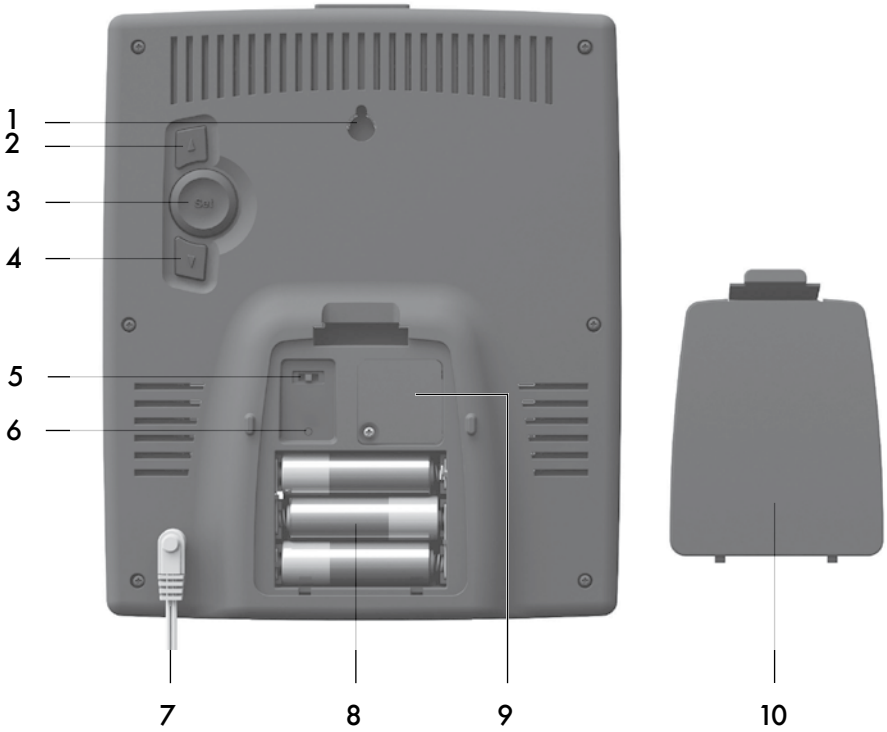

DISPLAY UNIT BACK

- 1. Integrated Hang Hole**
For easy wall mounting.
- 2. ▲ Button**
for setup preferences and viewing HIGH records.
- 3. SET Button**
for setup preferences.
- 4. ▼ Button**
for setup preferences and viewing LOW records.
- 5. A-B-C Switch**
ID code that must match sensor's A-B-C switch to ensure units synchronize.
- 6. RESET Button**
Full reset to factory defaults.
- 7. Plug-in For Power Adapter**
- 8. Battery Compartment**
- 9. Intelli-Time® Battery Compartment**
- 10. Battery Compartment Cover**

Sensor Setup

1 Set the A-B-C Switch

The A-B-C switch is located inside the battery compartment. It can be set to A, B or C. However, you must select the same letter choices for both the sensor and the display unit in order for the units to synchronize.

2 Install or Replace Batteries

AcuRite recommends high quality alkaline or lithium batteries for the best product performance. Heavy duty or rechargeable batteries are not recommended.

The sensor requires lithium batteries in low temperature

conditions. Cold temperatures can cause alkaline batteries to function improperly. Use lithium batteries in the sensor for temperatures below -20°C / -4°F.

1. Slide off the battery compartment cover. Take note of the A-B-C switch setting inside the battery compartment.
2. Insert 2 x AA batteries into the battery compartment, as shown. Follow the polarity (+/-) diagram in the battery compartment.
3. Replace the battery cover.

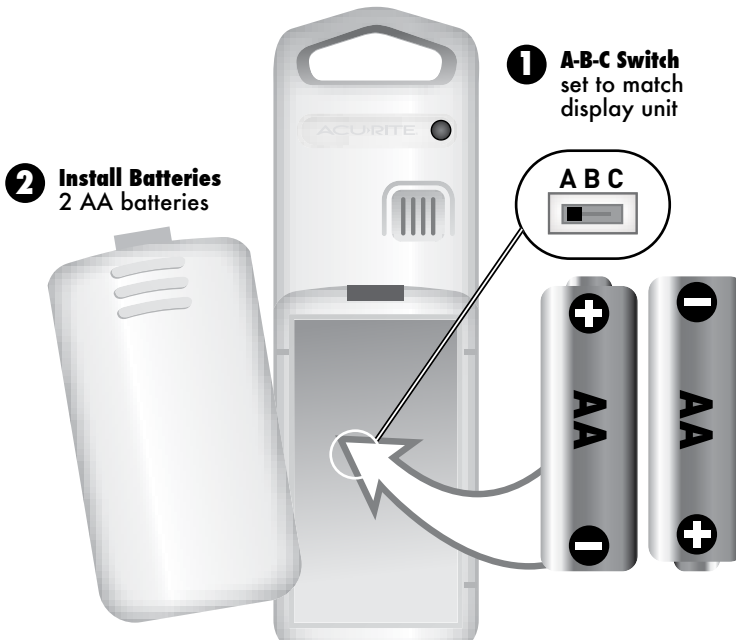

LITHIUM BATTERIES 4 C 4 F (158°F) **70°C**

ALKALINE BATTERIES **-20°C** (-4°F) (158°F) **70°C**

Display Unit Setup

1 Set the A-B-C Switch

Locate the A-B-C switch inside the battery compartment. Set the A-B-C switch to A, B or C. You must select the same letter choices for both the display unit and the sensor in order for the units to synchronize.

1 A-B-C Switch set to match sensor



2 Plug Power Adapter into Electrical Outlet

3 Install or Replace Backup Batteries (optional)

1. Remove the battery compartment cover.
2. Insert 3 x AA alkaline batteries into the battery compartment, as shown. Follow the polarity (+/-) diagram in the battery compartment.
3. Replace the battery cover.

3 Install Backup Batteries (optional) 3 AA batteries

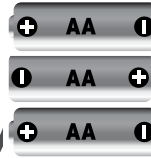

2 Plug in Power Adapter



IMPORTANT: Batteries are a backup power source to preserve records in the event of a power outage. Power adapter is the recommended primary power source to enjoy the full functionality of this product.



PLEASE DISPOSE OF OLD OR DEFECTIVE BATTERIES IN AN ENVIRONMENTALLY SAFE WAY AND IN ACCORDANCE WITH YOUR LOCAL LAWS AND REGULATIONS.

BATTERY SAFETY: Clean the battery contacts and also those of the device prior to battery installation. Remove batteries from equipment which is not to be used for an extended period of time. Follow the polarity (+/-) diagram in the battery compartment. Promptly remove dead batteries from the device. Dispose of used batteries properly. Only batteries of the same or equivalent type as recommended are to be used. DO NOT incinerate used batteries. DO NOT dispose of batteries in fire, as batteries may explode or leak. DO NOT mix old and new batteries or types of batteries (alkaline/standard). DO NOT use rechargeable batteries. DO NOT recharge non-rechargeable batteries. DO NOT short-circuit the supply terminals.

Intelli-Time® Clock

Intelli-Time products are pre-programmed with the correct time and date. Intelli-Time technology instructs the time and date to set themselves. All you need to do is select your Time Zone and Daylight Saving Time preferences. The clock will then automatically set itself and change for Daylight Saving Time.

Set the Time, Date & Units

Press and release the SET button to enter SETUP MODE. Once in setup mode, the preference you are currently setting will blink on the display.

To adjust the currently selected (flashing) item, press and release the “▲” or “▼” buttons (press and HOLD to fast adjust).

To save your adjustments, press and release the SET button again to adjust the next preference. The preference set order is as follows:

LANGUAGE (English or French)
COUNTRY (USA, CAN, AUS)
DST* (Daylight Saving Time ON or OFF)
TIME ZONE (PST MST CST EST AST HAT AKT NST AEST ACST AWST)
CLOCK HOUR
CLOCK MINUTE
CALENDAR MONTH
CALENDAR DATE
CALENDAR YEAR
TEMPERATURE SCALE (°F or °C)
BAROMETRIC PRESSURE SCALE (inHg or hPa)

*If you live in an area that observes daylight saving time, DST should be set to ON, even if it is not currently Daylight Savings Time.

You will automatically exit SETUP MODE if no buttons are pressed for 20 seconds. Enter setup mode at any time by pressing the SET button.

Display Backlight Settings

This weather station's color display features three different lighting settings: High (100%) brightness, Medium (60%) brightness and Low (30%) brightness.

Using battery power alone, the backlight is available momentarily for 10 seconds by pressing the “BACKLIGHT” button.

When display is powered with the power adapter, backlight remains on at 100% brightness. Press “BACKLIGHT” button once to dim to 60% brightness; press again to dim to 30%, press a 3rd time to enter “AUTO DIM” mode.

AUTO DIM MODE: Automatically adjusts display brightness based on time of day.
6:00 a.m. - 9:00 p.m. = 100% brightness
9:01 p.m. - 5:59 a.m. = 30% brightness

Placement for Maximum Accuracy

AcuRite sensors are sensitive to surrounding environmental conditions. Proper placement of both the display unit and outdoor sensor are critical to the accuracy and performance of this product.



Display Unit Placement

Place the display unit in a dry area free of dirt and dust. Display unit stands upright for tabletop use or is wall-mountable.



Outdoor Sensor Placement

Sensor must be placed outside to observe outdoor conditions. Sensor is water resistant and is designed for general outdoor use, however, to extend its life place the sensor in an area protected from direct weather elements.

Hang the sensor using the integrated hang holes or hanger, or by using string (not included) to hang it from a suitable location, like a well covered tree branch. The best location is 1 to 2 meters (4 to 8 feet) above the ground with permanent shade and plenty of fresh air to circulate around the sensor.

Important Placement Guidelines

- To ensure accurate temperature measurement, place units out of direct sunlight and away from any heat sources or vents.
- Display unit and outdoor sensor must be within 100 m (330 ft) of each other.
- To maximize wireless range, place units away from large metallic items, thick walls, metal surfaces, or other objects that may limit wireless communication.
- To prevent wireless interference, place both units at least .9 m (3 ft) away from electronic devices (TV, computer, microwave, radio, etc.).

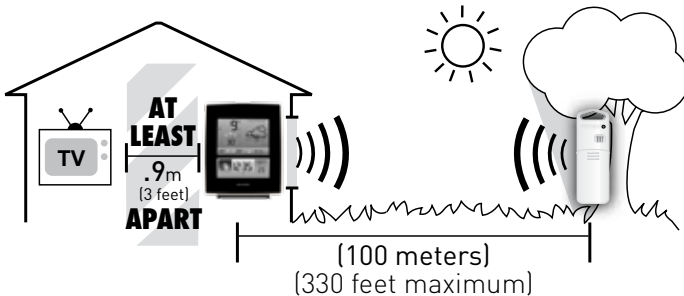

Setup is Complete

The sensor will now synchronize with the display unit. It may take a few minutes for synchronization to complete. Please refer to the troubleshooting section of this manual if anything appears to be functioning improperly.

Using the Weather Station Learning Mode

Self-Calibrating Forecasting uses a unique algorithm to analyze changes in pressure over a time period (called Learning Mode) to determine your altitude. After 14 days, the Learning Mode icon disappears from the display screen. At this point, the self-calibrated pressure is tuned in to your location and the unit is ready for superior weather prediction.

Weather Forecast

AcuRite's patented Self-Calibrating Forecasting provides your personal forecast of weather conditions for the next 12 to 24 hours by collecting data from the sensor in your backyard. It generates a forecast with pinpoint accuracy - personalized for your exact location.

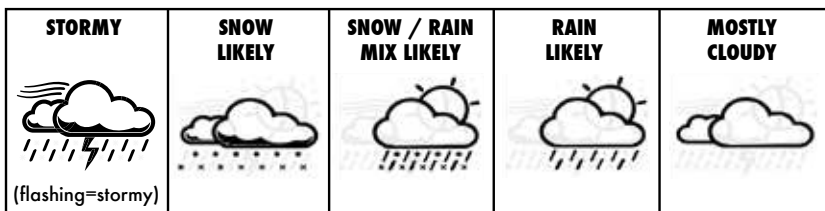

View the complete list of icons at www.AcuRite.com/acurite-icons

Barometric Pressure

Subtle variations in barometric pressure greatly affect the weather. This weather station displays the current pressure with an arrow icon to indicate the direction the pressure is trending (FALLING, STEADY, or RISING).

Moon Phase

Track the phases of the moon, conveyed through simple lunar phase icons:

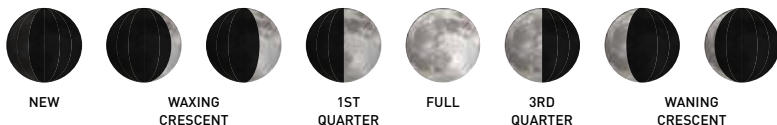

High & Low Records

Today's high and low records are displayed for indoor and outdoor temperature and humidity. Today's records automatically clear at 12:00am midnight every day. View today's high or low records by pressing and releasing the "▲" or "▼" buttons. Press and release again to view current readings.

To manually clear all of today's LOW recorded values, press and release the "▼" button to view low records, then press and hold the "▼" button for 2 seconds. Dashes display to confirm you have cleared the LOW records.

To manually clear all of today's HIGH recorded values, press and release the "▲" button to view high records, then press and hold the "▲" button for 2 seconds. Dashes display to confirm you have cleared the HIGH records.

Troubleshooting

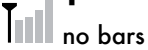
Problem	Possible Solution
<p>No outdoor sensor reception</p> 	<p>If the wireless signal indicator shows no bars:</p> <ul style="list-style-type: none"> • Relocate the display unit and/or the outdoor sensor. The units must be within 100 m (330 ft) of each other. • Make sure both units are placed at least .9 m (3 feet) away from electronics that may interfere with the wireless communication (such as TVs, microwaves, computers, etc). • Use standard alkaline batteries (or lithium batteries in sensor when temperature is below -20°C/-4°F). Do not use heavy duty or rechargeable batteries. NOTE: It may take up to 20 minutes for display unit and sensor to synchronize after batteries are replaced.
<p>Outdoor temperature is flashing or showing dashes</p>	<p>Flashing of the outdoor temperature is generally an indication of wireless interference.</p> <ol style="list-style-type: none"> 1. Bring both the sensor and display unit indoors and remove batteries from each. 2. Make sure the A-B-C switch on both units match. 3. Reinstall batteries in the outdoor sensor. 4. Reinstall batteries in the display unit. 5. Let the units sit within a couple feet of each other for about 20 minutes to gain a strong connection. Sometimes changing to a different channel can help.
<p>Inaccurate forecast</p>	<ul style="list-style-type: none"> • Weather Forecast icon predicts conditions for the next 12 to 24 hours, not current conditions. • Has Learning Mode icon disappeared from the display unit? Learning Mode must complete before forecast and pressure will be accurate. • Allow unit to run continuously for 33 days. Battery removal or resetting the display unit will restart Learning Mode. After 14 days, forecast should be fairly accurate, however Learning Mode calibrates for a total of 33 days.
<p>Inaccurate temperature or humidity</p>	<ul style="list-style-type: none"> • Make sure both the display unit and sensor are placed out of direct sunlight and away from any heat sources or vents (see page 8). • Make sure both units are positioned away from moisture sources (see page 8).

<p>Display screen not working</p>	<ul style="list-style-type: none"> • Check that the batteries are installed correctly. Batteries may need to be replaced. • Reset the display by pressing the reset button, located on the back of the display unit. Date and time will need to be entered after a reset.
<p>The unit lost power or batteries were changed and the time is not correct</p>	<ul style="list-style-type: none"> • The Intelli-Time battery needs to be replaced (see page 13). Once the new battery is installed, time and date will need to be set manually.

If your AcuRite product does not operate properly after trying the troubleshooting steps, visit www.AcuRite.com or call (877) 221-1252 for assistance.

Care & Maintenance

Display Unit Care

Clean with a soft, damp cloth. Do not use caustic cleaners or abrasives. Keep away from dust, dirt and moisture. Clean ventilation ports regularly with a gentle puff of air.

Outdoor Sensor Care

Clean with a soft damp cloth. Do not use caustic cleaners or abrasives.

Calibrate Temperature & Humidity

The indoor / outdoor temperature and humidity readings can be calibrated on the display unit to improve accuracy. Calibration can improve accuracy when sensor placement or environmental factors impact your data accuracy.

1. To access calibration mode, press AND HOLD the "▲", "Set", and "▲" buttons (located on the back of the display unit) for at least 5 seconds. Once in calibration mode, the preference you are currently setting will blink on the display.
 3. Press the "▲" or "▲" buttons to calibrate the data value higher or lower from the actual reading.
 4. Press the "Set" button to confirm the calibration adjustment. The "⌘" icon will remain illuminated next to calibrated values.
 5. The next adjustable data will begin flashing, indicating it is ready to be calibrated. Repeat Steps 1 - 4 to calibrate additional data.
- After 5 seconds of inactivity, the display will save the adjustments and exit calibration mode. Note: Calibrations will be erased if the display is reset or if batteries are removed and the power adapter is unplugged.

Calibrate Barometric Pressure

The weather station default pressure mode is "AUTO". In auto mode, the pressure will calibrate itself over a 14 day Learning Mode. Barometric pressure can be manually calibrated:

1. Press AND HOLD the "Set" button (located on the back of the display unit) for at least 10 seconds to enter manual pressure mode.
 2. The un-calibrated pressure will be displayed. Press AND HOLD the "▲", "▲", and "Set" buttons for at least 5 seconds.
 3. Press and release the "Set" button until barometric pressure is flashing.
 4. Press the "▲" or "▲" buttons to calibrate the data value higher or lower from the actual reading.
 5. Press the "Set" button to confirm the calibration adjustment. Note: The "⌘" icon will remain illuminated next to the calibrated value.
- After 5 seconds of inactivity, the display will save your adjustments and exit calibration mode. Note: Calibration will be erased if the display is reset or if batteries are removed and the power adapter is unplugged.
- To exit manual pressure mode and return to auto mode press and hold the "Set" button for at least 10 seconds.

Replace Intelli-Time Clock Battery

Intelli-Time technology is powered by a pre-installed coin-cell battery that stores the time and date settings. The battery has a shelf life of several years. Time and date will need to be entered after replacing Intelli-Time battery. To replace the Intelli-Time battery:

1. Locate the coin cell battery compartment door in the battery compartment of the display unit. Unscrew and remove the compartment cover.
2. Insert 1 x CR2032 coin cell battery into the battery compartment, as shown. Install battery with "+" positive terminal facing OUT.
3. Screw in the battery cover.

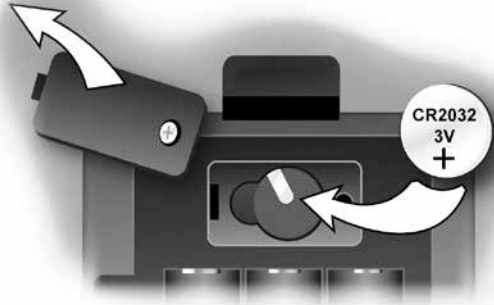

WARNING: THIS PRODUCT CONTAINS A BUTTON-CELL BATTERY. IF SWALLOWED, IT COULD CAUSE SEVERE INJURY OR DEATH IN JUST 2 HOURS. SEEK MEDICAL ATTENTION IMMEDIATELY IF INGESTED.



Specifications

TEMPERATURE RANGE	Outdoor: -40°C to 70°C; -40°F to 158°F
	Indoor: 0°C to 50°C ; 32°F to 122°F
HUMIDITY RANGE	Outdoor: 1% to 99% RH
	Indoor: 1% to 99% RH
WIRELESS RANGE	100 m / 330 ft depending on home construction materials
OPERATING FREQUENCY	433 MHz
POWER	Display: 5vdc power adapter 3 x AA alkaline batteries (optional)
	Sensor: 2 x AA alkaline or lithium batteries
DATA REPORTING	Outdoor: 16 second updates
	Indoor: 60 second updates

FCC Information

This device complies with part 15 of FCC rules. Operation is subject to the following two conditions:

1- This device may NOT cause harmful interference, and

2- This device must accept any interference received, including interference that may cause undesired operation.

WARNING: Changes or modifications to this unit not expressly approved by the party responsible for compliance could void the user's authority to operate the equipment.

NOTE: This equipment has been tested and found to comply with the limits for a Class B digital device, pursuant to Part 15 of the FCC rules. These limits are designed to provide reasonable protection against harmful interference in a residential installation. This equipment generates, uses and can radiate radio frequency energy and, if not installed and used in accordance with the instructions, may cause harmful interference to radio communications. However, there is no guarantee that interference will not occur in a particular installation. If this equipment does cause harmful interference to radio or television reception, which can be determined by turning the equipment off and on, the user is encouraged to try to correct the interference by one or more of the following measures:

- Reorient or relocate the receiving antenna.
- Increase the separation between the equipment and the receiver.
- Connect the equipment into an outlet on a circuit different from that to which the receiver is connected.
- Consult the dealer or an experienced radio/TV technician for help.

NOTE: The manufacturer is not responsible for any radio or TV interference caused by unauthorized modifications to this equipment. Such modifications could void the user authority to operate the equipment.

This device complies with Industry Canada licence-exempt RSS standard(s).

Operation is subject to the following two conditions:

(1) This device may not cause interference, and

(2) This device must accept any interference received, including interference that may cause undesired operation of the device.

Customer Support

AcuRite customer support is committed to providing you with best-in-class service. **For assistance**, please have the model number of this product available and contact us in any of the following ways:



(877) 221-1252



info@chaney-inst.com

24/7 support at www.AcuRite.com

- ▶ Installation Videos
- ▶ Register your Product
- ▶ Instruction Manuals
- ▶ Support User Forum
- ▶ Replacement Parts
- ▶ Submit Feedback & Ideas

Imported by: Costco Wholesale Australia Pty Ltd., 17-21 Parramatta Rd., Lidcombe, NSW 2141.

ACU>RITE®



Weather
Stations



Temperature
& Humidity



Weather
Alert Radio



Kitchen
Thermometers
& Timers



Clocks

It's more than accurate, it's ACU>RITE.

AcuRite offers an extensive assortment of precision instruments, designed to provide you with information you can depend on to Plan your day with confidence™.

www.AcuRite.com

©Chaney Instrument Co. All rights reserved. AcuRite is a registered trademark of the Chaney Instrument Co., Lake Geneva, WI 53147. All other trademarks and copyrights are the property of their respective owners. AcuRite uses patented technology. Visit www.AcuRite.com/patents for details.