

CE CAMRegis Data logger

User manual



AKO-15740 **AKO-15750** **AKO-15780**
AKO-15742 **AKO-15752** **AKO-15782**

Index	Pag
Warnings	3
1.- Presentation.....	4
1.1.- Versions and references.....	4
1.2.- Maintenance.....	4
1.3.- Description	5
2.- Operation.....	6
2.1.- Data logging.....	6
2.2.- Display modes.....	7
2.3.- Fast printing.....	7
2.4.- Consult recorded data	8
2.5.- Battery mode operation.....	10
3.- Access permits	10
4.- Installation	11
4.1.- Wiring	12
4.2.- Connectivity.....	13
4.3.- Installing the thermal paper roll.....	13
5.- Configuration.....	14
5.1.- Language.....	14
5.2.- System configuration.....	14
5.3.- Input configuration.....	15
5.4.- Text editor	16
5.5.- Contrast.....	16
6.- Table of parameters.....	17
7.- Specification	18

AKO Electromecánica thanks and congratulates you for purchasing our product, in whose development and manufacture the most innovative technology has been used, as well as strict production and quality control processes.

Our commitment to satisfy our customers and our continuous efforts to improve every day can be seen in the various quality certifications we have obtained.

This is a high performance, high technology product. The operation and final performance of the equipment depend on proper planning, installation, configuration and commissioning. Read this manual carefully before installation, and always follow its instructions.

Only qualified personnel should install or perform technical assistance on this product.

This product is designed to be used in the applications described in the product manual. AKO Electromecánica gives no guarantee of its operation in any use not foreseen in the manual, and is not responsible for any damage resulting from improper use, configuration, installation or commissioning.

It is the responsibility of the installer and the customer to comply with and ensure others comply with all regulations applicable to installations incorporating our products. AKO Electromecánica is not responsible for any damage caused by non-compliance with regulations. Follow strictly the instructions given in this manual.

To maximise the service life of our equipment, these recommendations should be followed:

- Do not expose electronic equipment to dust, dirt, water, rain, humidity, high temperatures, chemicals or corrosive substances of any sort.

- Do not submit the equipment to blows or vibrations nor try to manipulate it differently from shown in the manual.

- Never exceed the specifications and limitations indicated in the manual.

- Always respect the specified ambient working and storage conditions.

- During and after installation, avoid leaving loose, broken, unprotected or damaged wiring, since they might constitute a risk for the equipment and its users.

AKO Electromecánica reserves the right to make any non-metrology modification to the documentation or the equipment without previous notice.



WARNINGS

- The unit must be installed in a location protected from vibrations, water and corrosive gases, where the ambient temperature does not exceed that shown in the technical data.
- In order for the controllers to have IP65 protection, the gasket between the equipment and the perimeter of the panel cut-out where the panel is to be installed must be correctly installed.
- Use only probes supplied by **AKO** to ensure proper operation of the equipment.
- To get a correct reading, the probe must be placed in a location without any external heat influences except for the temperature which is being measured or controlled.
- The probe and its cable **must be installed in a separate conduit** away from any other type of conduits.
- If the NTC probe is being extended, always use shielded cable and connect the grid to ground. In these cases, the maximum deviation is 0.25 °C between -40 °C and +20 °C (maximum of 1,000 m with a minimum section of 0.5 mm²). **AKO-15586** cable is recommended.
- Always disconnect the power supply before making any connections.
- The power supply circuit must be provided with a main switch rated at least 2 A, 230 V, located close to the equipment.
- The power cable must be H05VV-F or H05V-K. The section to be used will depend on local regulations, but should in no case be less than 1 mm².
- Using the logger contrary to the manufacturer's instructions may affect the device's safety requirements.
- The graph paper is thermal and therefore if you wish to keep the graphs for a long time you must make photocopies. The length of an input's graph is less than the length of a sheet of DIN A4.
- With the recording frequency or interval set to 15 minutes, the loggers keep the information in memory for over one year. They therefore ensure compliance with **UNE EN 12830**, enabling graphs to be printed or displayed when required.
- If frequencies of less than 15 minutes are configured, in order to comply with **UNE EN 12830**, the graphs must be printed before the memory ends and be kept for one year.



Units that incorporate rechargeable electrical accumulators:

This unit has built-in accumulators which must be replaced when the autonomy of the unit is less than the duration shown in the specifications. At the end of the unit's life, the accumulators must be taken to a selective disposal centre or returned to the equipment manufacturer. The battery included has integrated protection, only replace with the **AKO-15704** part.



Periodic checks:

In accordance with standard **UNE EN 12830**, maintenance must include the checks indicated in the **UNE EN 13486** standard (only with the **AKO-14931** NTC probes).



IMPORTANT: Prior to the installation of the equipment, connect the battery cable (1) to the panel connector (2).

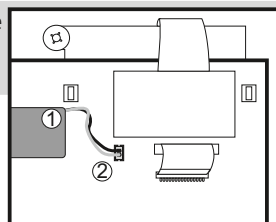

1.- Presentation

CAMRegis is a solution for capturing, storing and recording temperatures and other physical variables such as humidity and pressure.

They have an internal memory that allows data storage of up to 6 years recording at 30 minutes, and a battery that provides up to 6 hours for recording data and up to 3 months for maintenance of date and time in the event of a power failure.

The data stored can be displayed on screen or printed by means of the unit's own printer (depending on the model).

1.1.- Versions and references

MODELS	INPUTS	PRINTER	RELAYS (250V, $\cos \varphi=1$)	POWER SUPPLY
AKO-15740	10	NO	Max. alarm: 6A SPDT Max. alarm: 6A SPDT	100 - 240 Vac 50/60 Hz \pm 3 Hz
AKO-15742	10	YES		
AKO-15750	5	NO		
AKO-15752	5	YES		
AKO-15780	2	NO		
AKO-15782	2	YES		

1.2.- Maintenance

Clean the surface of the alarm using a soft cloth, soap and water. Do not use abrasive detergents, petrol, alcohol or solvents.

1.3.- Description

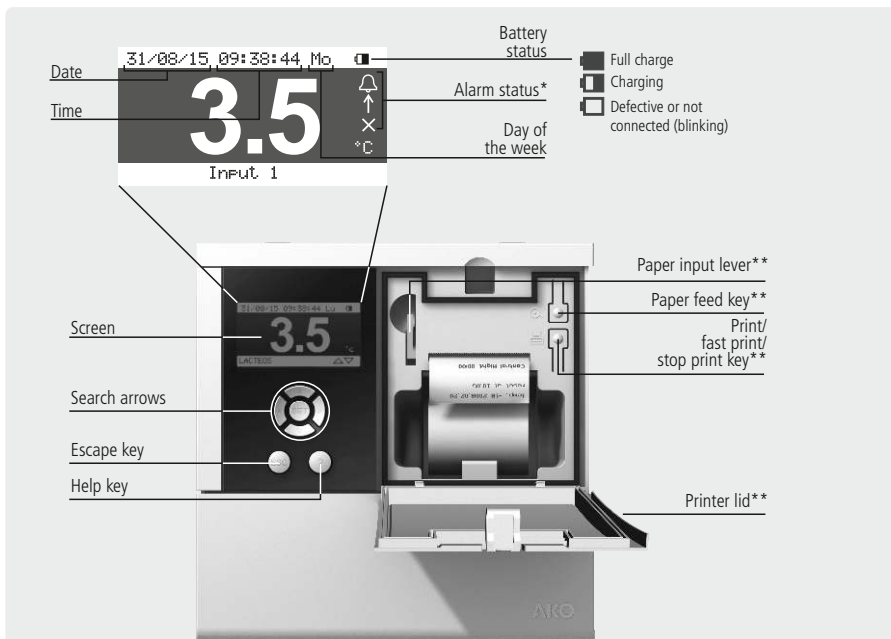

Keypad functions

- Horizontal scrolling. Changes display modes.
- Vertical scrolling/Change value. Changes the input to be displayed.
- Confirms selection. Pressing it for 5 sec. the programming menu is accessed.
- Allows you to exit without saving changes (Programming). Returns to the previous menu or exits programming.
- Displays the help text for the parameter or function selected.

NOTE: The alarms are silenced by pressing any of the above keys.

On models with printer.

- Paper feed
- On standby, prints the graph of the last calendar week logged.***
From the logger menu, prints the data or the graph shown on the screen.
From the alarm menu, prints the alarm log.
Stops any printing in progress.

*Alarm status

- Alarm activated
- Alarm signal activated
- Alarm signal muted/disabled
- Maximum alarm
- Minimum alarm
- Digital input activation

Err Probe error (open/crossed/off-scale)

** Only AKO-15742/15752/15782
*** If the recording interval is 15'.

2.- Operation

2.1.- Data logging

The logged data are saved in log blocks, each log block saves a given period of time depending on the "Log interval" parameter, as shown:

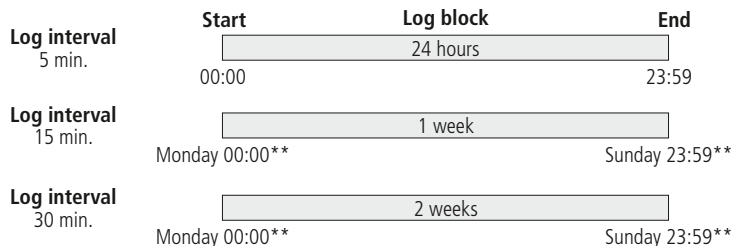

** According to parameter "Log start day"

If any change is made in the configuration that affects the parameters indicated on page 17, the ongoing block is closed and a new one is started with the new configuration.

All the blocks have the same capacity and start at the same time and on the same day of the week (if the recording interval is 15 or 30 min.).

Whenever a new block starts, it is identified with its starting date and time.



EXAMPLES (Recording interval 15 min.):

① If the device is started on **Wednesday 4 March 2015 at 14:02**, the recording interval is **15 min.** and the recording starting day is **Monday**, the first block will have as **Monday 2 March 2015 at 00:00** as its starting date, but will not contain any data until **Wednesday at 14:15**.

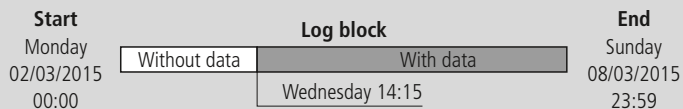

② If changes are made to the recorder's configuration on **Thursday 19 March 2015 at 09:40**, the ongoing block is closed and a new one is started. Therefore, there will be two recording blocks with the same name but with different content, as shown:

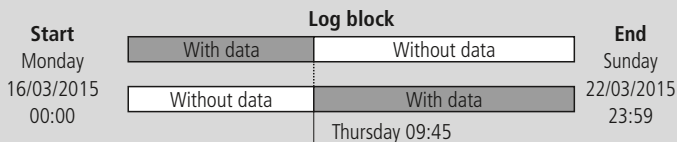

①	02/03/2015 00:00 S=15 N0000
②	09/03/2015 00:00 S=15 N0001
	16/03/2015 00:00 S=15 N0002
	16/03/2015 00:00 S=15 N0003
	23/03/2015 00:00 S=15 N0004
	30/03/2015 00:00 S=15 N0005
	06/04/2015 00:00 S=15 N0006
	13/04/2015 00:00 S=15 N0007

2.2.- Display modes

There are four possible modes for displaying instantaneous input readings. Press ◀ or ▶ to toggle between the various modes:

Individual input information

Sequential input information

List of inputs

Summary of inputs (only AKO-15740/AKO-15742)

* Alarm status

🔔 Alarm activated 🔊 Alarm signal activated ✕ Alarm signal muted/disabled
 ⬆ Maximum alarm ⬇ Minimum alarm 🗑 Digital input activation **Err** Probe error

2.3.- Fast printing (Only AKO-15742/15752/15782)

When the logger is displaying the data for a specific date and input ("Graph", "List" or "Histogram" display modes), when the 🖨 key is pressed, the device prints the data displayed on the screen.

When the logger is displaying the configuration change log or alarm log, when the 🖨 key is pressed, the device prints the data displayed on the screen.

Log interval	Period to be printed
5 min.	24 hours
15 min.	Last complete week
30 min.	14 days



EXAMPLE: If the parameter "Log start day" is set at "Monday" and the "Log interval" is set at "15 min." (default configuration), the log block starts on Monday at 00:00 and closes on Sunday at 23:59.

2.4.- Consult recorded data

This allows displaying and printing the data logged by the device, press the **SET** key and select one of the four options:

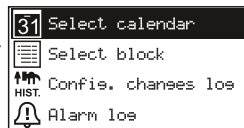

Selection by calendar

Use the **◀**, **▶**, **▲** and **▼** keys to select a date and press **SET**, the log block corresponding to the selected date will be displayed. Each block contains the data for a full week**.

February 2015							Block: 2
Mo	Tu	We	Th	Fr	Sa	Su	
3	4	5	6	7	8	9	
10	11	12	13	14	15	16	
17	18	19	20	21	22	23	
24	25	26	27	28	29	30	
31							

(SET)

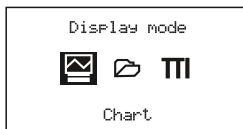

If the selected day contains more than one log block, you must select one of the available blocks. The crossed out days do not contain data.

Selection by block

Use the **▲** and **▼** keys to select a log block, each log block contains the data for a full week**.

02/03/2015 00:00	S=15	N0000
03/03/2015 00:00	S=15	N0001
16/03/2015 00:00	S=15	N0002
23/03/2015 00:00	S=15	N0003
30/03/2015 00:00	S=15	N0004
06/04/2015 00:00	S=15	N0005
13/04/2015 00:00	S=15	N0006
20/04/2015 00:00	S=15	N0007

(SET)

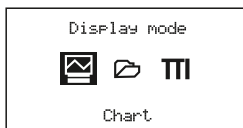

Data presentation



Graph

Use the **◀** and **▶** keys to move the selector for displayed logs.

Use the **▲** and **▼** keys to change the input to be displayed.

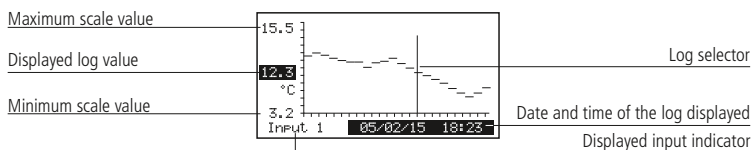

List

Use the **▲** and **▼** keys to move around the logs.

Input 1		
02/02/2015 15:00	18.7	°C
02/02/2015 15:15	18.2	°C
02/02/2015 15:30	9.9	°C
02/02/2015 15:45	9.2	°C
02/02/2015 16:00	9.0	°C
02/02/2015 16:15	8.6	°C
02/02/2015 16:30	8.1	°C

Displayed input indicator

Date and time of the log

Displayed log value

** Only if the log interval is 15 min.

Histogram

Use the ▲ and ▼ keys to change the input to be displayed.

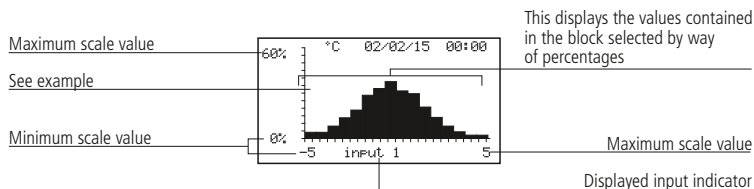

Example: 38% of the records correspond to the value 0.5 °C.

Configuration changes log

This displays a list with the changes made in the configuration of the device.

Date and time of the change	Type of change (see table)
02/02/2015 16:45	U2
24/05/2015 10:02	U3
08/07/2015 09:34	GL:1
15/09/2015 19:28	U0
21/09/2015 07:47	U1
14/10/2015 13:12	U1

User who changed the configuration
U0: Non-configured users
U1/2/3/4/5: User 1/2/3/4/5
 (See page 10)

Types of configuration changes		
GL:1 Date/Time	GL:13 User name 1	ix: 00 Input type
GL:2 Date format	GL:14 User password 1	ix: 01 Value at 4 mA
GL:3 Automatic time change	GL:15 User name 2	ix: 02 Value at 20 mA
GL:4 Log interval	GL:16 User password 2	ix: 03 Offset
GL:5 Log start day	GL:17 User name 3	ix: 04 Display units
GL:6 Temperature units	GL:18 User password 3	ix: 05 Description
GL:7 Mute Alarm	GL:19 User name 4	ix: 06 Enable alarm
GL:8 Delete log	GL:20 User password 4	ix: 07 Max. alarm level
GL:9 Default parameters	GL:21 User name 5	ix: 08 Min. alarm level
GL:10 Modbus adress	GL:22 User password 5	ix: 09 Alarm delay
GL:11 Modbus speed	GL:23 Idioma	ix: 10 Alarm output
GL:12 Acces rights	GL:24 Contrast	

ix: I0 (Input 1) - I9 (Input 10)

Alarm log

This displays a list with the alarms logged in the device, use the ◀ and ▶ keys to select the input to be displayed.

Logged temperature	Input	Alarm type
05/02/15 12:41	Input 1	↑ 12.6°C
05/02/15 12:55	X	↓ 10.3°C
16/05/15 09:05	X	E
16/05/15 10:18	X	E
01/06/15 09:00	J	
01/06/15 09:39	X	J

Alarm type

- ↑ Maximum alarm activation
- ↓ Minimum alarm activation
- J Digital input activation
- E Probe error
- X ↑ Maximum alarm deactivation
- X ↓ Minimum alarm deactivation
- X J Digital input deactivation
- X E Probe error deactivation

Printing displayed data

When the logger is displaying the data for a specific date and input ("Graph", "List" or "Histogram" display modes), when the  key is pressed, the device prints the data displayed on the screen.

When the logger is displaying the configuration change log or alarm log, when the  key is pressed, the device prints the data displayed on the screen.

2.5.- Battery mode operation

In the event of a power failure, the device continues to log all inputs for 6 hours, but deactivates the display and printing of data to minimise consumption.

3.- Access permits

This function prevents unauthorised users from accessing parameter configuration.

It allows the creation of up to 5 user profiles, each with a four figure password. When configuration is accessed, you must select one of the users and enter his/her password. If the latter is not correct, you will not be able to gain access.

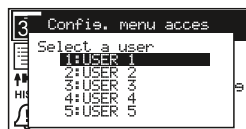

Change each figure using the ▲ and ▼ keys.

Press **SET** to accept it and go to the next one.

When you press **SET** on the last figure, if the code is correct, you gain access the configuration menu.

The "Configuration changes log" allows the user who has made changes in the configuration of the device to be identified.

If a user enters the wrong password three times in a row, this user's access to the configuration will be blocked. In order to unblock it, the device will ask for a specific numerical key, which can be found in the following table:

1	2	3	4	5	6	7	8	9	10
2421	5832	1294	5119	0547	8168	3632	5901	8533	1942
11	12	13	14	15	16	17	18	19	20
7145	3044	6197	8134	4800	3319	0237	5565	2098	4291

4.- Installation

Wall mounting

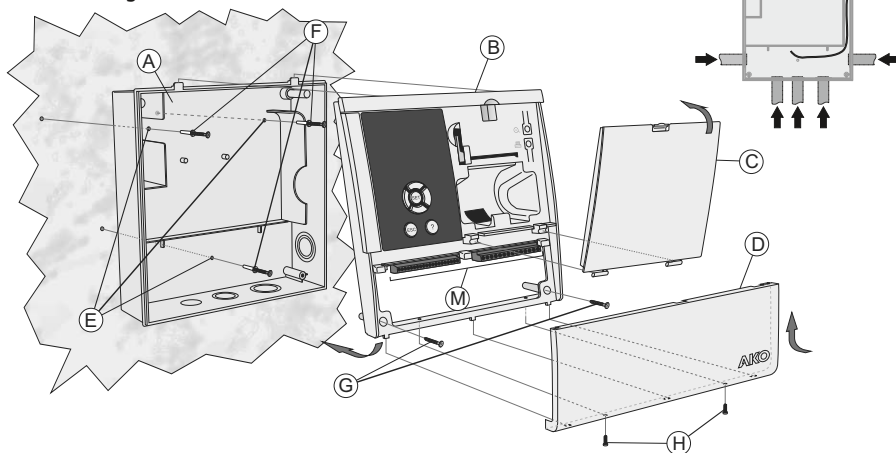

- Remove the connection panel (D).
- Remove the front (B) from the housing (A).

Panel mounting only

- Replace the gasket installed in the front panel with the included panel mounting gasket (K).
- Make a hole of the specified size in the panel (Fig.2).
- Select the most appropriate cable input configuration for the installation (fig. 1).
- Drill the holes for the cable glands using the pre-stamped holes as a guide.

Wall mounting only

- Drill 3 holes in the wall to match the fixing holes on the housing (E).
- Insert and tighten the 3 bolts and wall plugs (F).

Panel mounting only

- Finish drilling the top holes (L) with a 4 mm bit.

- Insert the cables through the cable glands. If you choose the upper inlets, guide the cables as shown on figure 1.
- Connect the battery cable to the panel connector (Page 13).

Wall mounting only

- Fit the front of the housing (B).
- Insert and tighten the two screws on the front (G).

Panel mounting only

- Attach the front to the housing, through the panel, and affix it with the screws provided (G and J).

- Connect cables following the drawings in page 12.
- Close the connection panel (D), insert and tighten the fixing screws (H).

Panel mounting

(maximum panel thickness: 3 mm)

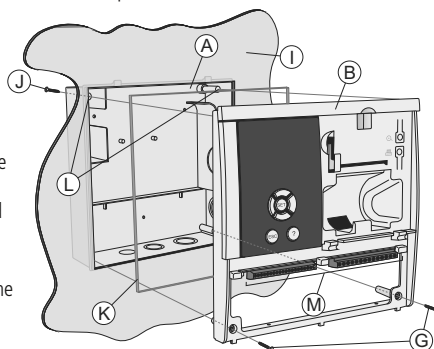

(fig. 2)

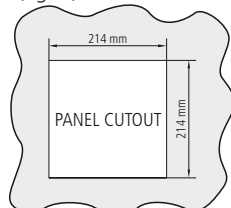

4.1.- Wiring

Supply and outputs



CAUTION: The power supply circuit should be equipped with a switch for turning it off, located close to the device.

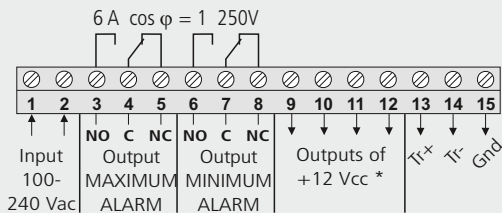

Probes

AKO-15740/15742

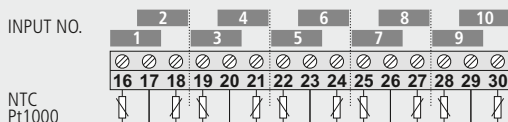

Example of connection of other probes:

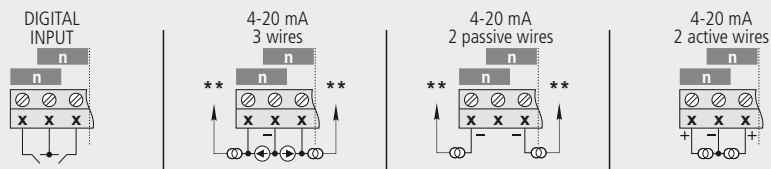

AKO-15750/15752/15780/15782

Only AKO-1575x

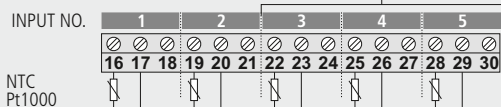

Example of connection of other probes:

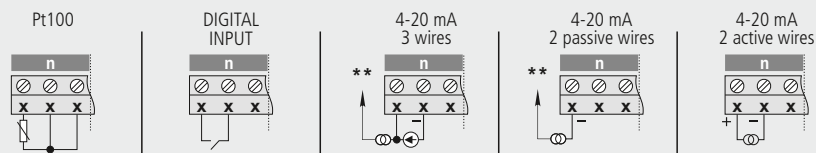

* The sum of the 4 outputs must not exceed 250 mA

** Connect to one of the + 12V output terminals (terminals 9 al 12) (Not available in battery mode operation)

For more information about the connection of humidity probes consult Manual 358004001 on our website: www.ako.com

4.2.- Connectivity

CAMRegis loggers have a port for connection of RS485 (MODBUS) data, that allow remotely managing them using a PC with the **SOFTRegis**, **AKONet** software or an **AKO-5011** server.

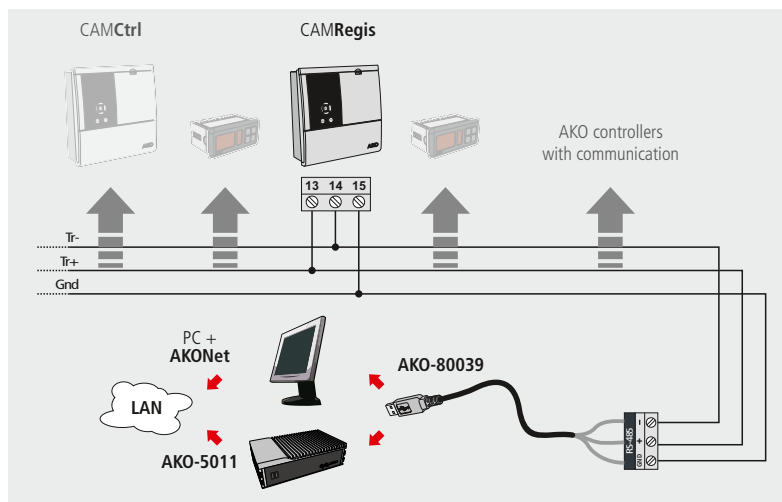

A different address must be assigned for each device in the same network, this address is defined using the **Configuration - Modbus Address parameter**.

Recommended cable: **AKO-15586**



4.3.- Installing the thermal paper roll

AKO-15742/15752/15782 only

- With the unit connected to the network, open the front cover and push the release lever (1) back.
- Place the paper roll in the position shown on the image.
- Push the end of the paper through the bottom slot of the printer until the latter starts to pull it. When the paper comes out of the top slot, return the release lever to its initial position, the printer is ready to print.
- Press the  key to feed the paper through.
- Press the  key for express printing.

To print data, the data logger has to have at least one entry recorded. The required printing time will depend on the entry interval configuration (default is 15').

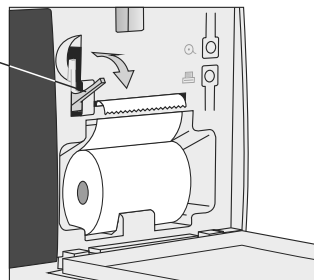

IMPORTANT: The printer paper is thermal and can only be printed on one side. Make sure you insert it properly.

5.- Configuration

To access the programming menu, press the **SET** key for 5 secs.

If access permits have been activated, you must select one of the 5 available users and enter the corresponding password.

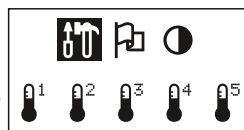

5.1- Language



Defines the language of the logger menus.



Allows you to change the language of the menus and texts in general displayed on the screen.

Select the language using the ▲ and ▼ keys, then press **SET** to accept.

5.2- System configuration



Parameters related to the logger's configuration.

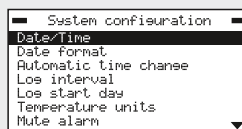

Date/Time

Set the current date and time.

Date format

It changes the way the date is displayed on the screen and the printer.

Automatic time change

It allows changes from summer / winter time to be made automatically (only in the European Union).

Log interval

Defines the time that passes between the capture of one piece of data and the next. Allows you to choose 5, 15 or 30 minutes.

This parameter affects certain of the unit's characteristics as shown in the table.

Recording interval	Storage capacity	Fast printing
5 min.	> 5 months	Previous day
15 min.	3 years (aprox.)	1 calendar week
30 min.	6 years (aprox.)	2 calendar weeks

Log start day

It determines on what day of the week each recording block starts (see page 6).

Temperature units

It sets the temperature to be displayed in °C or in °F.

Mute alarm

It configures alarm behaviour when any key is pressed:

No: The alarm cannot be silenced.

Buzzer only: The warning tone is disconnected but the alarm relay is still activated.

Relay only: The alarm relay is deactivated but the sound is still active.

Buzzer & Relay: Both the alarm relay and the sound are deactivated.

Delete logs

It deletes all data saved in the recorder to present date (memory deletion). To avoid accidental deletions, the device will ask for confirmation.



WARNING: This operation deletes all data recorded (except the “configuration change log”) by the device to date. **This data cannot be recovered.** During the deletion process, the device might not respond for about 10 seconds.

Default parameters

If “YES” is selected, the device returns to the factory settings. To avoid accidental activations, the device will ask for confirmation.

The data recorded to present date is not modified, but the recording block under way is closed and a new one is opened.

MODBUS address

It sets the MODBUS address of the device if connecting it in a network (See page 13).

MODBUS speed

It sets the speed of MODBUS communications in bps, Consult the monitoring software manual (AKONet or SOFTRegis).

Access rights

It activates or deactivates user profiles to limit access to configuration of parameters.

User name n

It sets the name of each user.

User password n

It sets the password of each user.

5.3.- Input configuration



It allows the settings of each input to be edited.

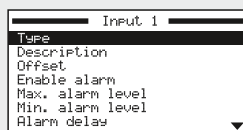

Type

Select the type of input depending on the element connected to it and press **SET** to validate.

Disabled: There is no element connected.

NTC: There is an NTC probe connected.

Pt100: There is a PT100 probe connected (only AKO-1575x and AKO-1578x).

Pt1000: There is a Pt1000 probe connected.

4-20mA: There is a 4-20mA converter connected.

DI-NO: Digital input, normally open contact.

DI-NC: Digital input, normally closed contact.

Value at 4mA (Sólo para 4-20mA)

Defines the equivalent value of the 4-20mA converter for a 4mA current.

Value at 20mA (Sólo para 4-20mA)

Defines the equivalent value of the 4-20mA converter for a 20mA current.

Description:

It allows a name with up to 10 characters to be entered in order to describe the input (Cold Room 1, Fruit, Ext. probe, etc.), using the built-in text editor.

Display units (Only 4-20mA)

Define the units to be displayed using the built-in text editor.

Offset

It allows a possible reading error in the probe to be corrected. This may be very useful when it cannot be put into the most suitable place.

Enable alarm

It allows the maximum and minimum alarms to be activated. Select one of the following options:

No: The alarms are disabled.

Minimum: Only the minimum value reached alarm is enabled.

Maximum: Only the maximum value reached alarm is enabled.

Minimum and Maximum: The maximum and minimum value reached alarms are enabled.

Max. alarm level

Defines the maximum value from which the alarm will be activated.

Min. alarm level

Defines the minimum value at which the alarm will be activated.

Alarm delay

It configures the delay time from when the maximum or minimum value is reached until the alarm is activated (in minutes).

Alarm output

It configures the behaviour of the alarm output:

No output: The alarm is only displayed on screen.

Buzzer only: The alarm is displayed on the screen and it activates an acoustic signal.

Relay only: The alarm is displayed on the screen and it activates the maximum or minimum alarm relay.

Buzzer & Relay: The alarm is displayed on the screen, it activates an acoustic signal and activates the maximum or minimum alarm relay.

5.4.- Text editor

In order to facilitate the interpretation of data, you can customise the names of each input with a description of up to 10 characters. If the input type is 4-20mA, you will also be able to edit the display units.

The lower section of the screen shows the changes carried out during the editing process.

- Use the arrow keys ◀, ▶, ▲ and ▼ to scroll through the various available characters and options and the **SET** key to confirm the selection.
- Select ✂ to delete the highlighted text.
- Select ◀ or ▶ to scroll within the text being edited.
- Select 💾 to save your changes and exit the edit menu.

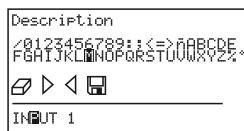
**5.5- Contrast**

Set the screen's contrast level by pressing keys ◀ and ▶.

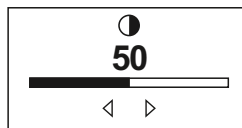

6.- Table of parameters



Configuration

	Description	Units	Min	Def	Max.
B	Date/Time		1	1	31
B	Date format: Day/Month/Year Month/Day/Year Year/Month/Day		-	D/M/Y	-
	Automatic time change Yes No		-	Yes	-
B	Log interval 5 15 30	Min.	5	15	30
B	Log start day Monday Tuesday Wednesday Thursday		-	Monday	-
B	Temperature units °C °F		-	°C	-
	Mute Alarm No Buzzer only Relay only Buzzer & Relay		-	Buzzer o.	-
B	Delete log Yes No		-	No	-
B	Default parameters Yes No		-	No	-
	Modbus address		1	1	255
	Modbus speed 9600 19200 38400 57600	bps	-	9600	-
	Acces rights Yes No		-	No	-
	User name 1		-	USER 1	-
	User password 1		0	1234	9999
	User name 2		-	USER 2	-
	User password 2		0	1234	9999
	User name 3		-	USER 3	-
	User password 3		0	1234	9999
	User name 4		-	USER 4	-
	User password 4		0	1234	9999



Language

	Description	Units	Min	Def	Max.
	Idioma: Español English Français Deutsch				
	Italiano Português русский			-	



Input n configuration

	Description	Units	Min	Def	Max.
B	Type: Disabled NTC Pt100* Pt1000		-	Dis.	-
B	Value at 4 mA 4-20mA DI-NO DI-NC		-999.9	0	999.9
B	Value at 20 mA		-999.9	100	999.9
	Description		-	Input n	-
	Display units		-	-	-
B	Offset		-20.0	0.0	20.0
	Enable alarm No Minimum Maximum Minimum and Maximum		-	No	-
	Max. alarm level		-999.9	999.9	999.9
	Min. alarm level		-999.9	-999.9	999.9
	Alarm delay	min.	0	0	120
	Alarm output No output Relay only Buzzer only Buzzer + Relay		-	No output	-

* AKO-1575x and AKO-1578x Only.

B When you change any of these parameters, the log block closes and a new one starts.

7.- Specification

Range varies by type of probe configured:

NTC (AKO-14931)	-50°C to 105°C (-58.0°F to 221°F)
Pt1000	-150°C to 550°C (-238°F to 1022°F)
4-20 mA	-999 to 999

AKO-1575x and AKO-1578x only

Pt100 (AKO-1558xxx / AKO-1559x)	-150°C to 590°C (-238°F to 1094°F)
Resolution	0.1°C from -99.9 to 99.9, elsewhere 1°C

Thermometric precision

NTC (AKO-14931)	from -50°C to 105°C ±1°C
Pt100	from -100°C to 100°C ±2°C, elsewhere ±2%
Pt1000	from -100°C to 100°C ±2°C, elsewhere ±2%
4-20 mA	±1% (mA)

Designation with NTC

.....	EN 12830, S, A, 1, -40°C +40°C
.....	EN 13485, S, A, 1, -40°C +40°C

Power supply 100 - 240 V~ 50/60 Hz

Maximum power absorbed **AKO-157x0** 10 VA

AKO-157x2 20 VA

Ambient working temperature 0°C to 45°C

Ambient storage temperature -30°C to 70°C

Alarm relays SPDT 6A

Double insulation between supply, secondary circuit and relay output.

Installation category II according to EN 61010-1

Pollution classification II according to EN 61010-1

Equipment intended for installations at up to 2000m above sea level.

Battery Li-Polymer (AKO-15704) + cell (Cr2032)

Internal buzzer



NOTE FOR THE SPANISH MARKET

This device complies with the UNE EN 12830 standard

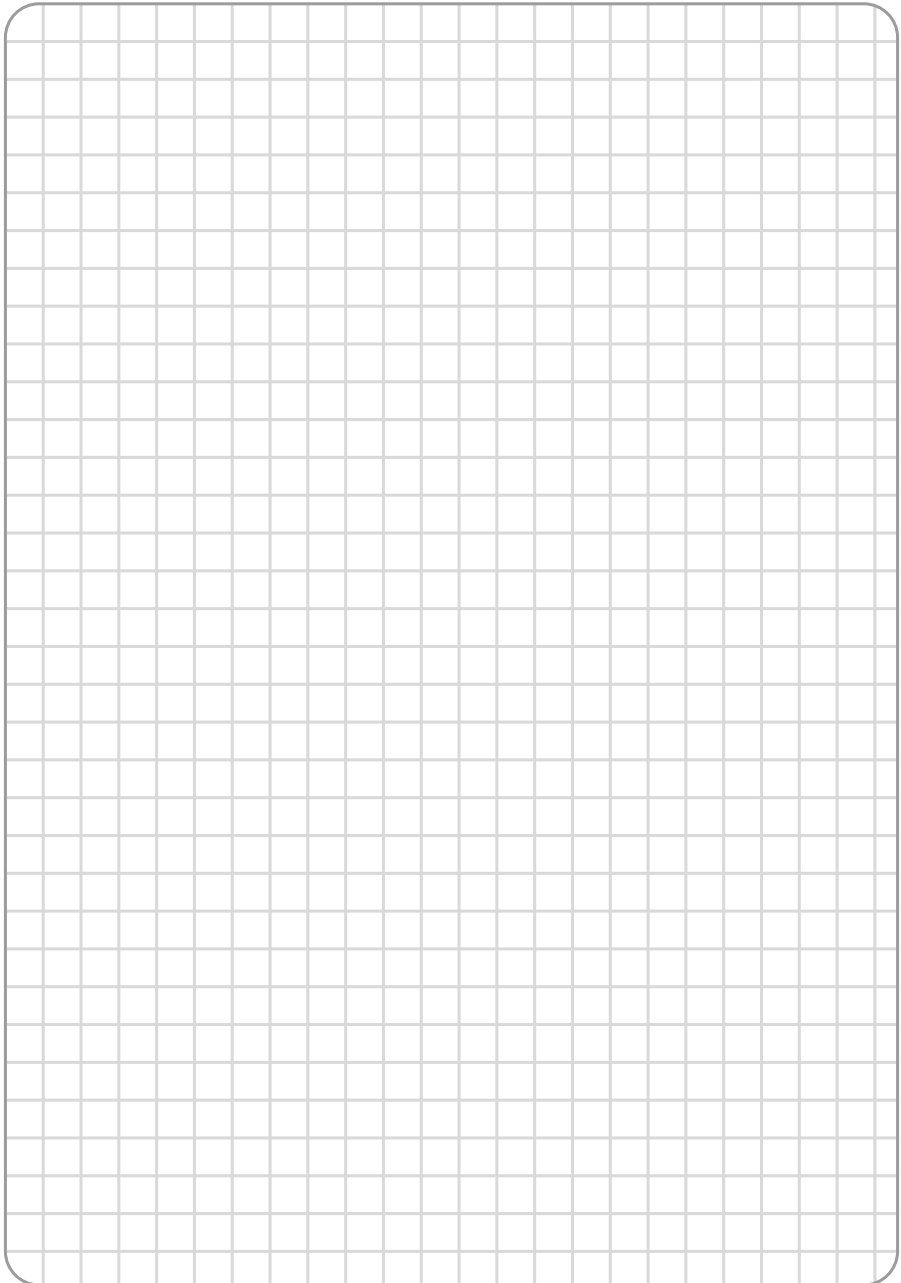



AKO ELECTROMECÁNICA, S.A.
Av. Roquetes, 30-38 | 08812 Sant Pere de Ribes | Barcelona | España
www.ako.com

We reserve the right to supply materials that might vary slightly to those described in our Technical Sheets. Updated information is available on our website.

351575112 REV/03 2026