



1080p Outdoor Wi-Fi Camera

Quick Start Guide

ADC-V723

Pre-installation checklist

- ADC-V723 camera (included).
- AC power adapter (included).
- Wireless (2.4 or 5 GHz) connection to broadband (Cable, DSL, or Fiber Optic) internet.
- A computer, tablet, or smartphone with Wi-Fi is required if the router does not have the Wi-Fi Protected Setup (WPS) feature.
- For the fastest installation, we recommend using the mobile app or MobileTech (the app for Service Provider technicians).

There are two options for connecting the V723 to the Wi-Fi network: Access Point (AP) mode or Wi-Fi Protected Setup (WPS) mode. Use WPS mode if you have easy access to the customer's router and the router has the WPS feature enabled. Note that some Internet Service Providers disable the WPS feature on customer routers. AP mode is the most reliable method for installing this device.

In the box

- V723 camera
- Mounting plate
- Power supply
- Installation guide
- Wall anchors & screws (x2)

Overview

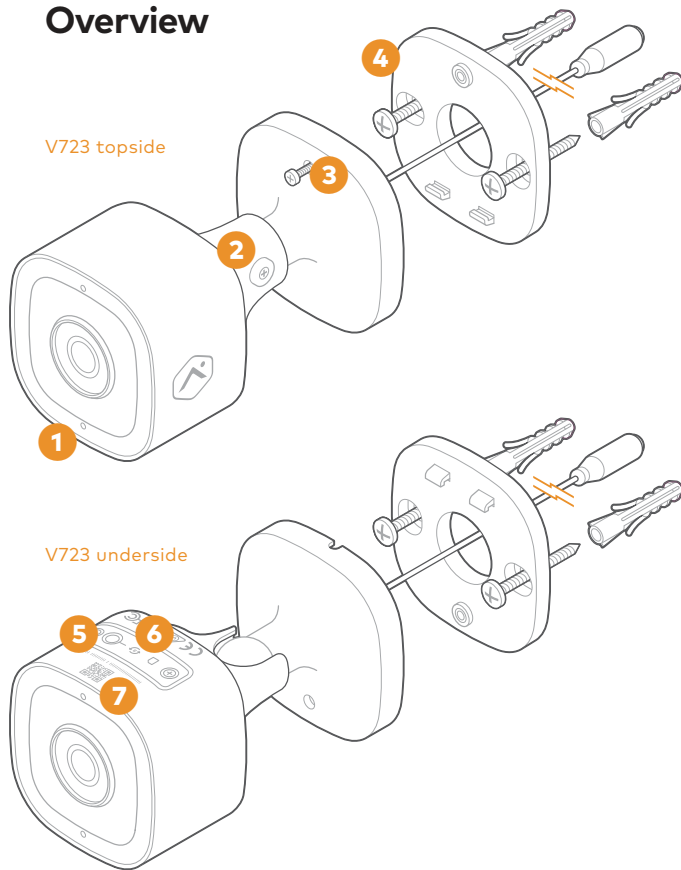

- | | |
|-----------------------|--|
| 1 LED indicator | 5 Reset button  |
| 2 Set screw | 6 SD card door |
| 3 Base securing screw | 7 MAC address + QR code |
| 4 Mounting plate | |

Articulation

Camera
body rotation

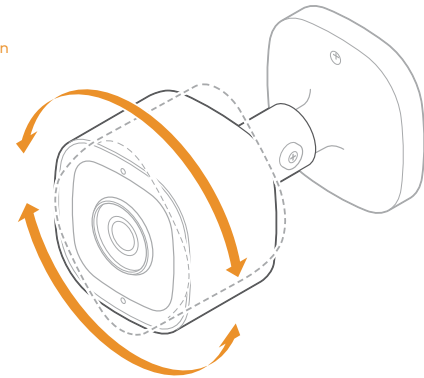

Vertical tilt

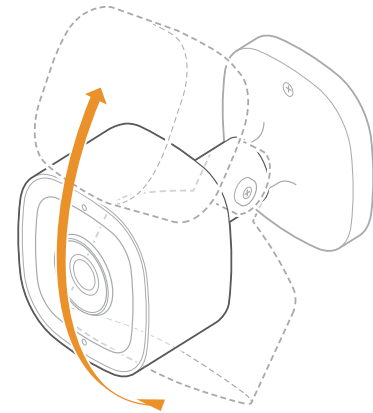

Collar rotation

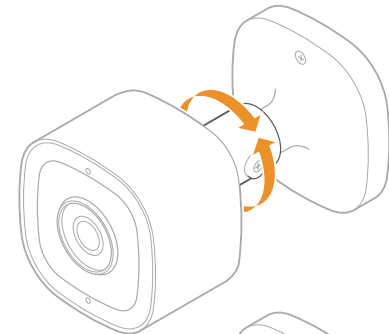

Camera
body pan

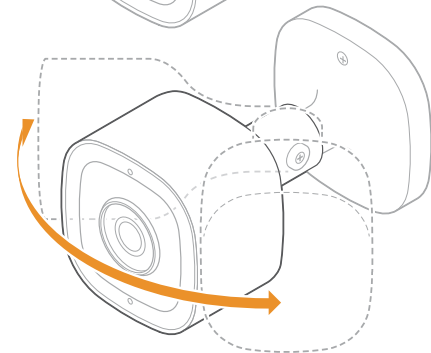

Installation

Choose the appropriate installation wizard (customer or technician) below or proceed to the AP mode or WPS mode section to begin adding the camera.

Customer - mobile app installation wizard

If you are a customer, please download the mobile app in the app store. If you already use the mobile app, please make sure that you are using the latest version.



To begin, scan the QR Code with your phone's camera app or follow these simple instructions:

- 1 Log in to the mobile app.
- 2 Tap the navigation menu ☰.
- 3 Tap **+ Add Device > Video Camera > ADC-V723**. (If you do not see the Add Device option, please use the AP mode or WPS mode instructions below to complete your installation.)
- 4 Follow the on-screen instructions to finish adding the camera.

Service provider technician - MobileTech installation

- 1 Log in to MobileTech.
- 2 Select the customer's account.
- 3 Tap **Quick Actions > Add Device > Video**.
- 4 Follow the on-screen instructions to finish adding the camera.

AP mode

To ensure sufficient Wi-Fi signal, complete these steps with the camera near its final location but prior to mounting.

- 1 Connect the camera's AC power adapter and plug it into a non-switched outlet.
- 2 The camera's LED will begin to flash white. If the LED is not white after two minutes, hold down the **Reset button**  and release when the LED begins to flash white (about 6 seconds).
- 3 On an Internet enabled device, connect to the wireless network **ADC-V723 (XX:XX:XX)** where XX:XX:XX is the last six digits of the ADC-V723's MAC address, which is located on the bottom of the camera or on the packaging.
- 4 On the same device, open a web browser and enter **http://v723install** in the URL field. Follow the on-screen instructions to add the ADC-V723 to the Wi-Fi network. The LED will be solid green when the connection is complete.

- 5 Add the device to the account by either selecting the account in MobileTech or by using a web browser and entering the following URL: **www.alarm.com/addcamera** (you will need the customer's user name and password if using the Customer Website).
- 6 Select the camera from the video device list or type in its MAC address to begin adding the camera. The camera's MAC address is located on the bottom of the camera or on the packaging.
- 7 Follow the on-screen instructions to finish adding the camera. You may configure camera settings from the Customer Website.

You can now power down the camera and install it in its final location using the included hardware.









WPS mode

To ensure a sufficient Wi-Fi signal, complete these steps with the camera near its final location but prior to mounting.

- 1 Connect the camera's AC power adapter and plug it into a non-switched outlet.
- 2 Hold down the **Reset button**  on the bottom of the camera and release when the LED begins to flash blue (about 3 seconds).
- 3 Activate the WPS Mode on the router. The router will begin to connect to the wireless network. The LED will be solid green when the connection is complete.
- 4 Add the device to the account by either selecting the account in MobileTech or by using a web browser and entering the following URL: **www.alarm.com/addcamera** (you will need the customer's user name and password if using the Customer Website).
- 5 Select the camera from the video device list or type in its MAC address to begin adding the camera. The camera's MAC address is located on the bottom of the camera or on the packaging.
- 6 Follow the on-screen instructions to finish adding the camera.

You may configure camera settings from the Customer Website. You can now power down the camera.

LED reference guide

	Off	Power off
	Solid green	Connected to Alarm.com
	Flashing green	Local network connection
	Flashing green+red	Camera reverting to factory default settings
	Solid red	No local or Internet connection
	Flashing red	Power on, camera booting
	Flashing blue	WPS mode
	Flashing white	Wi-Fi access point mode

Troubleshooting

- If you have issues connecting the camera to the account, power cycle the camera and try again.
- If issues persist, reset the camera to factory defaults. Press and hold the **Reset button**  located on the bottom of the camera until the LED is flashing Green and Red (about 15 seconds), then release the button. The camera will reboot with factory defaults.

If the camera was previously installed to an Alarm.com account, it will need to be deleted before it can be installed again.

Prolonged exposure to sunlight in extreme conditions may impact the camera's performance. The optimal installation location is in a shaded area such as under an eave.

Questions?

Visit: answers.alarm.com
or contact your service provider

Notices

Note: This equipment has been tested and found to comply with the limits for a Class B digital device, pursuant to part 15 of the FCC Rules. These limits are designed to provide reasonable protection against harmful interference in a residential installation. This equipment generates, uses and can radiate radio frequency energy and, if not installed and used in accordance with the instructions, may cause harmful interference to radio communications. However, there is no guarantee that interference will not occur in a particular installation. If this equipment does cause harmful interference to radio or television reception, which can be determined by turning the equipment off and on, the user is encouraged to try to correct the interference by one or more of the following measures:

- Reorient or relocate the receiving antenna.
- Increase the separation between the equipment and receiver.
- Connect the equipment into an outlet on a circuit different from that to which the receiver is connected.
- Consult the dealer or an experienced radio/TV technician for help. Changes or modifications not expressly approved by the party responsible for compliance could void the user's authority to operate this equipment

This device contains licence-exempt transmitters(s)/receiver(s) that comply with Innovation, Science and Economic Development Canada's licence-exempt RSS(s). Operation is subject to the following two conditions:

- This device may not cause interference.
- This device must accept any interference, including interference that may cause undesired operation of the device.

Cet appareil contient des émetteurs/récepteurs exemptés de licence conformes à la norme Innovation, Sciences, et Développement économique Canada. L'exploitation est autorisée aux deux conditions suivantes:

- L'appareil ne doit pas produire de brouillage.
- L'utilisateur de l'appareil doit accepter tout brouillage radioélectrique subi, même si le brouillage est susceptible d'en compromettre le fonctionnement.



8281 Greensboro Drive
Suite 100
Tysons, VA 22102