



Push ONE

Programming Guide

MT02-0101-xxx010_v1.0_07062023

SAFETY

WARNING: Important safety instructions to be read before installation and use.

Incorrect installation or use can lead to serious injury and will void manufacturer's liability and warranty. It is important for the safety of persons to follow the enclosed instructions.

Save these instructions for future reference.

- Do not expose to water, moisture, humid and damp environments or extreme temperatures.
- Persons (including children) with reduced physical, sensory or mental capabilities, or lack of experience and knowledge, should not be allowed to use this product.
- Use or modification outside the scope of this instruction manual will void warranty.
- Installation and programming to be performed by a suitably qualified installer.
- Follow installation instructions.
- For use with motorized shading devices.
- Frequently inspect for improper operation.
- Do not use if repair or adjustment is necessary.
- Keep clear when in operation.
- Replace battery with correctly specified type.

Do not ingest battery, Chemical Burn Hazard.

This product contains a coin/button cell battery. If the coin/button cell battery is swallowed, it can cause severe internal burns in just 2 hours and can lead to death.

Keep new and used batteries away from children. If the battery compartment does not close securely, stop using the product and keep it away from children.

If you think batteries might have been swallowed or placed inside any part of the body, seek immediate medical attention.

Do not dispose of in general waste. FCC ID: 2AGGZ003B9ACA50 IC: 21769-003B9ACA50



Operation Temperature Range: -10°C to +50°C Ratings: 3VDC, 15mA

FCC & ISED STATEMENT

This device complies with part 15 of the FCC Rules. Operation is subject to the following two conditions: (1) This device may not cause harmful interference, and (2) this device must accept any interference received, including interference that may cause undesired operation.

Caution: Changes or modifications to this unit not expressly approved by the party responsible for compliance could void the user's authority to operate the equipment.

This device contains licence-exempt transmitter(s)/ receiver(s) that comply with Innovation, Science and Economic Development Canada's licence-exempt RSS(s). Operation is subject to the following two conditions:

- (1) This device may not cause interference.
- (2) This device must accept any interference, including interference that may cause undesired operation of the device.

L'émetteur/récepteur exempt de licence contenu dans le présent appareil est conforme aux CNR d'Innovation, Sciences et Développement économique Canada applicables aux appareils radio exempts de licence. L'exploitation est autorisée aux deux conditions suivantes :

- 1) L'appareil ne doit pas produire de brouillage;
- 2) L'appareil doit accepter tout brouillage radioélectrique subi, même si le brouillage est susceptible d'en compromettre le fonctionnement.

NOTE: This equipment has been tested and found to comply with the limits for a Class B digital device, pursuant to part 15 of the FCC Rules. These limits are designed to provide reasonable protection against harmful interference in a residential installation. This equipment generates, uses and can radiate radio frequency energy and, if not installed and used in accordance with the instructions, may cause harmful interference to radio or television reception, which can be determined by turning the equipment off and on, the user is encouraged to try to correct the interference by one or more of the following measures:

- Reorient or relocate the receiving antenna.
- Increase the separation between the equipment and receiver.
- Connect the equipment into an outlet on a circuit different from that to which the receiver is connected.
- Consult the dealer or an experienced radio/TV technician for help.

ASSEMBLY

Please refer to separate Rollease Acmeda System Assembly Manual for full assembly instructions relevant to the hardware system being used.

BATTERY MANAGEMENT

For battery motors; Prevent discharging the battery completely for extended periods, recharge as soon as the battery is discharged.

CHARGING NOTES
Charge your motor for 6-8hours, depending on the motor model, as per motor instructions.

During operation, if battery is low, the motor will beep 10 times to prompt the user it needs charging.

PRODUCT RANGE & P1 LOCATIONS

The Quick Start Programming Guide is universal for all Automate Motors including:

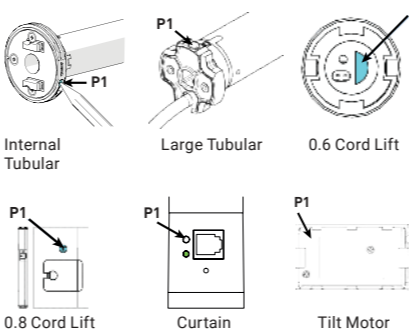

Note: Curtain motor does not Jog but instead LED flashes

INSTALLER BEST PRACTICE AND TIPS

SLEEP MODE
If pre-programmed: before shipping the motor ensure the motor is put into sleep mode so it doesn't activate during transit.

LOCK REMOTE
Prevent users accidentally changing the limit; ensure the remote is locked as your last step of programming.

ZONE/GROUPS
Ask the customer the day before to think how shades will be zoned on the remote. This may save an extra call out.

SETTLE FABRIC
Run the fabric up and down several times to ensure fabric has settled to some extent and re adjust the limits if needed.

CHARGE 100%
For battery motors ensure the motor is fully charged as per instructions.

INSTALLERS REMOTE
Use a spare remote to individually program each shade. Then use that remote to group rooms as per the user's needs. If you go back and service the installation later then, that same remote can be used to check the individual shades.

WALL MOUNTING

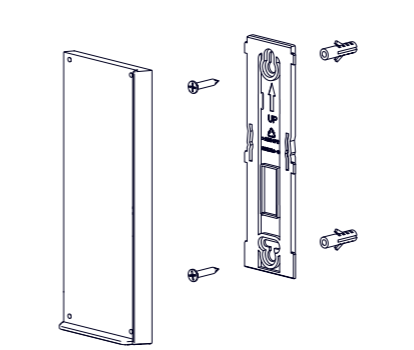

Use supplied fasteners and anchors to attach the base to wall.

BUTTON OVERVIEW

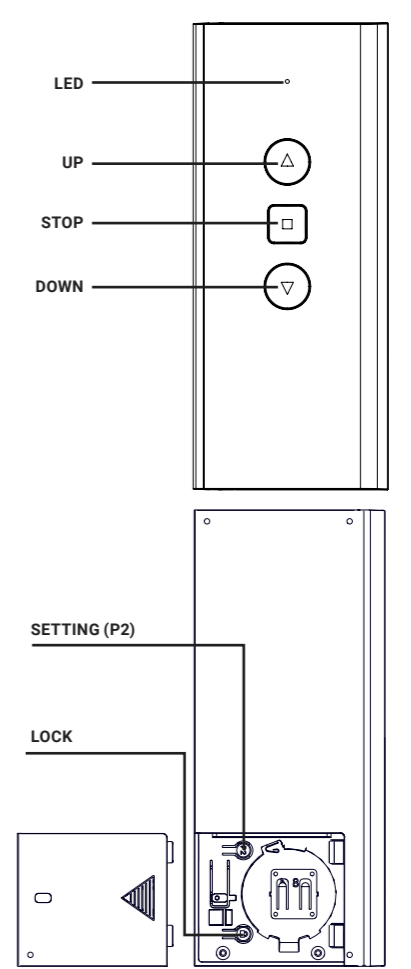

REPLACE BATTERY

STEP 1.
Use a tool (such as a SIM card pin, mini screwdriver, etc.) to push the battery cover release button and simultaneously slide the battery cover in the direction shown.

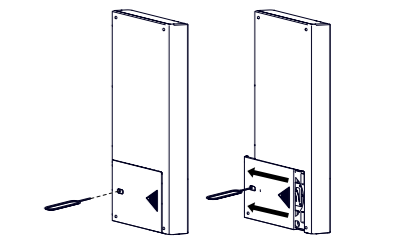

STEP 2.
Install CR2450 Battery with positive (+) side facing up.

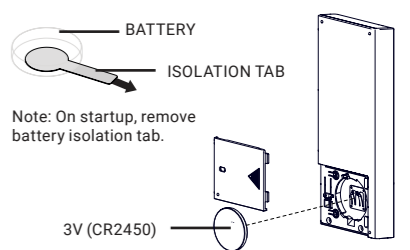

STEP 3.
Slide up to lock the battery door.

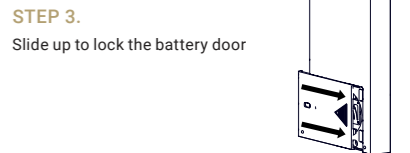

INSTALLER

INSTALLER

This setup wizard should be used for new installation or factory reset motors only. Individual steps may not work if you haven't followed the setup from the beginning.

ON REMOTE

STEP 1.

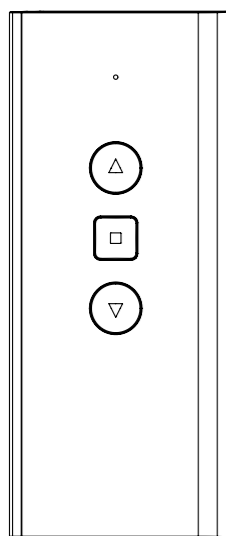

STEP 2.

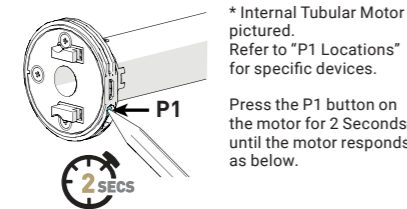

* Internal Tubular Motor pictured. Refer to "P1 Locations" for specific devices.
Press the P1 button on the motor for 2 Seconds until the motor responds as below.

MOTOR RESPONSE



Within 4 seconds hold the stop button on the remote for 3 seconds. The motor will respond with Jog and Beep.

CHECK DIRECTION

STEP 3.

Press up or down to check the motor direction. If correct skip to step 5.



CHANGE DIRECTION

STEP 4.

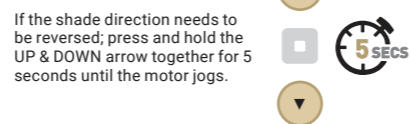

MOTOR RESPONSE



Reversing motor direction using this method is only possible during initial set-up.

SET TOP LIMIT

STEP 5.

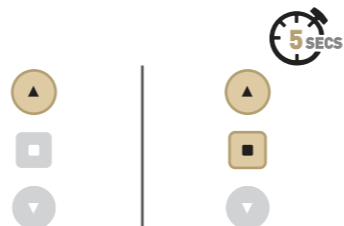

Move shade to desired top limit by pressing the up arrow repeatedly. Then press and hold up & stop together for 5 sec to save limit.

MOTOR RESPONSE



Tap the arrow several times or hold down if needed; press arrow to stop.

SET BOTTOM LIMIT

STEP 6.

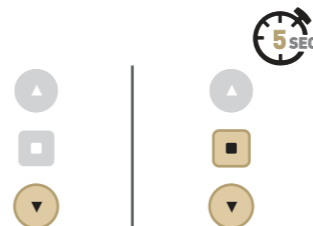

Move shade to desired bottom limit by pressing the down arrow repeatedly. Then press and hold down & stop together for 5 sec to save limit.

MOTOR RESPONSE



Tap the arrow several times or hold down if needed; press arrow to stop.

SAVE YOUR LIMIT

STEP 7.

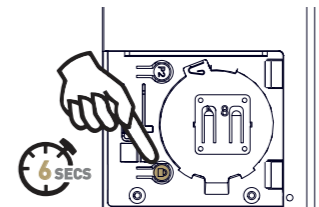

Repeat steps 1-6 for all motors before locking the remote.

Once complete Press and hold the Lock button for 6 seconds while looking at the LED, and hold until solid.

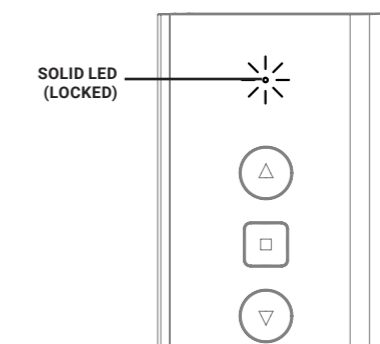

MOTOR RESET PROCEDURE FACTORY RESET

To reset all settings in the motor press and hold the P1 Button for 14 seconds, you should see 4 independent jogs followed by 4x Beeps at the end.

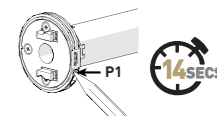

(Internal Tubular pictured above. Refer to "P1 Locations" for specific devices.)

MOTOR RESPONSE

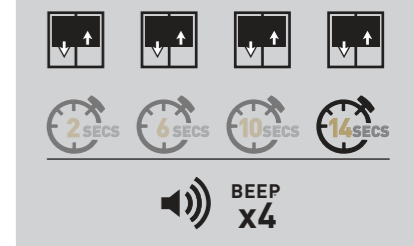

CONTROLLING A SHADE

CONTROL SHADE UP

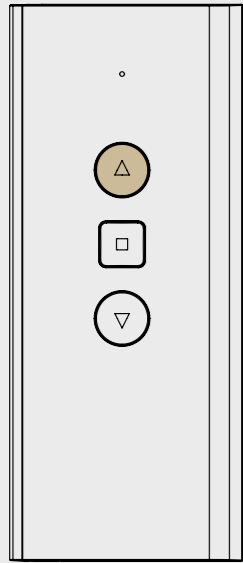

CONTROL SHADE DOWN

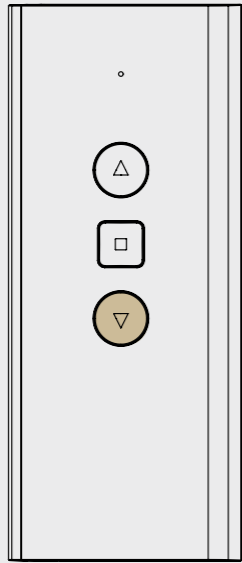

STOPPING THE SHADE

Press the STOP button to stop shade at any point.

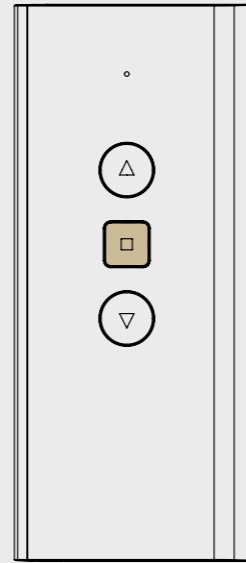

DISABLE LIMIT SETTING - LOCK BUTTON

Note: Ensure all shade programming for all motors is completed before locking the remote.

This mode is intended to be used after all shade programming is completed. User Mode will prevent accidental or unintended changing of limits.

LOCK REMOTE

Pressing the lock button for 6 second will Lock the remote and LED will show solid.

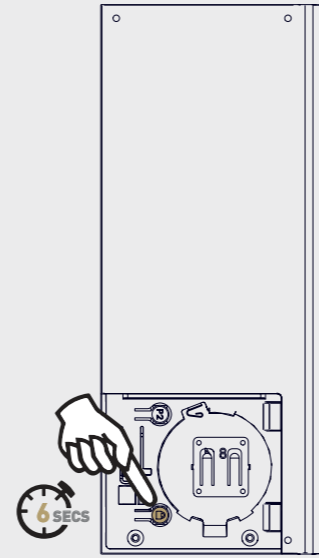

SOLID LED (LOCKED)

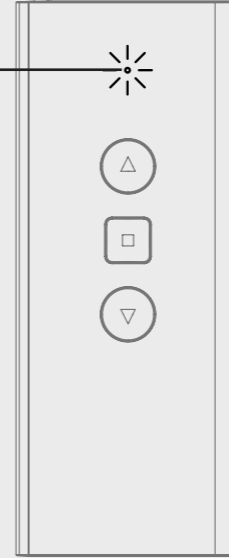

UNLOCK REMOTE

Pressing the lock button for 6 second will Unlock the remote and LED will show flashing.

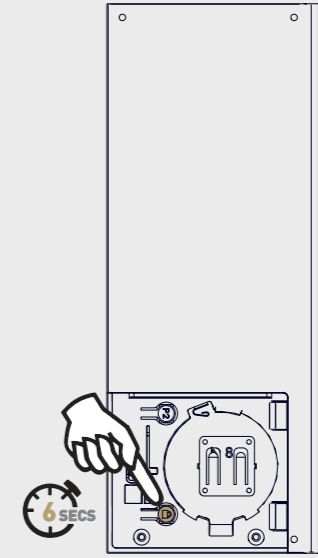

FLASHING LED (UNLOCKED)

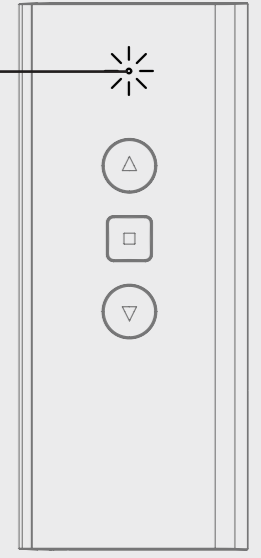

SET A FAVORITE POSITION

Move shade to desired position by pressing UP or DOWN on the remote.

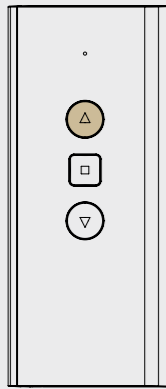

OR

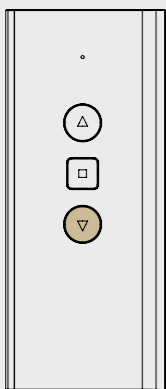

Press P2 on remote.

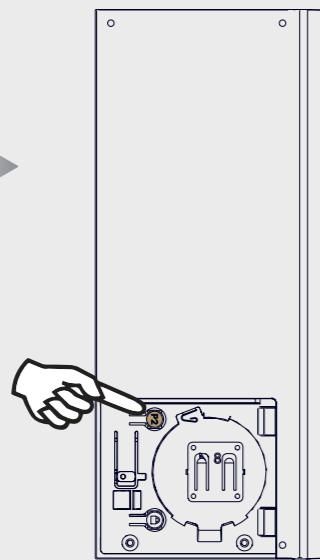

MOTOR RESPONSE



Press STOP on remote.

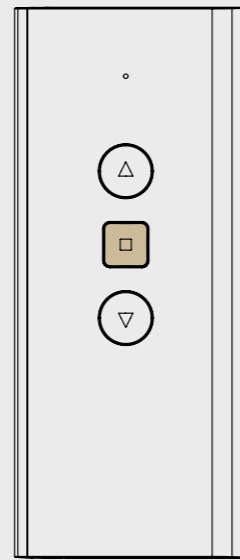

MOTOR RESPONSE (First Time)



Press STOP on remote again.

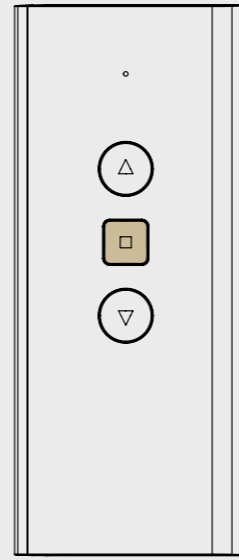

MOTOR RESPONSE (Second Time)



DELETE FAVORITE POSITION

Press P2 on remote.

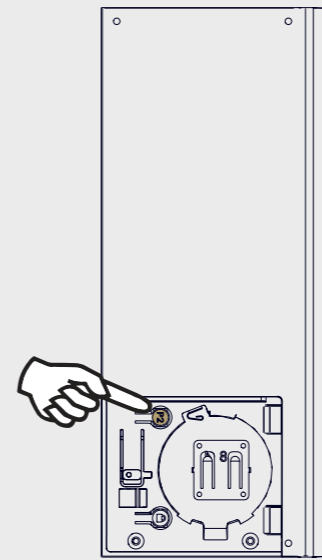

MOTOR RESPONSE



Press STOP on remote.

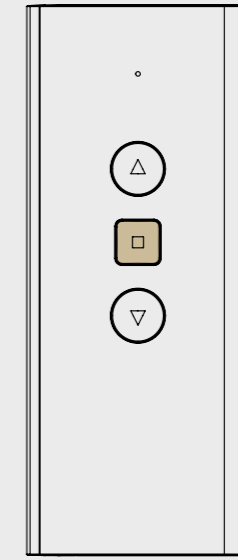

MOTOR RESPONSE



Press STOP on remote.

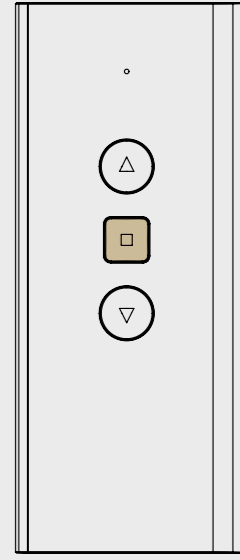

MOTOR RESPONSE

