

BAUHN®

1080P HOME THEATER FULL HD PROJECTOR



Model No: AFHDP-0825

USER MANUAL

AFTER SALES SUPPORT

  1300 002 534

 tempo.org/support

MODEL: AFHDP-0825 | Sellable ID: 673542 08/2025



Welcome

Congratulations on choosing to buy a BAUHN product.

All products brought to you by BAUHN are manufactured to the highest standards of performance and safety and, as part of our philosophy of customer service and satisfaction, are backed by our comprehensive 1 Year Warranty.

We hope you will enjoy using your purchase for many years to come.

Contents

Welcome	2
Product Overview	5
Operation	10
Distance for Projection	13
Troubleshooting	14
Specifications	15
Compliance and Responsible Disposal	16

Safety

The following safety instructions ensure the long service life of the projector to avoid fire or electric shock. Make sure to read them carefully and pay attention to all the following warnings.

- Do not install the projector in sites with improper ventilation.
- Do not install the projector in hot and humid sites.
- Do not block the ventilation holes(intake or exhaust).
- Do not install the projector in dust and smoke sites.
- Do not install the projector near the temperature and smoke transducer. It may cause a sensor failure.
- Do not install the projector in sites with direct blowing of warm and cool air-conditioning. Doing so may cause the projector to fail due to moisture condensation or temperature



To avoid possible hearing damage, do not listen at high audio volume for long periods of time.

Product Overview

What's in the box:

- A. Projector
- B. Projector Carry Bag
- C. Power Cable
- D. HDMI Cable
- E. AV Adaptor Cable
- F. Remote Control
- G. AAA Batteries (x2)
- H. Lens Cleaning Fabric
- I. Warranty Certificate
- J. General Safety Warning
- K. User Manual



Product Overview cont.

Ports and Controls

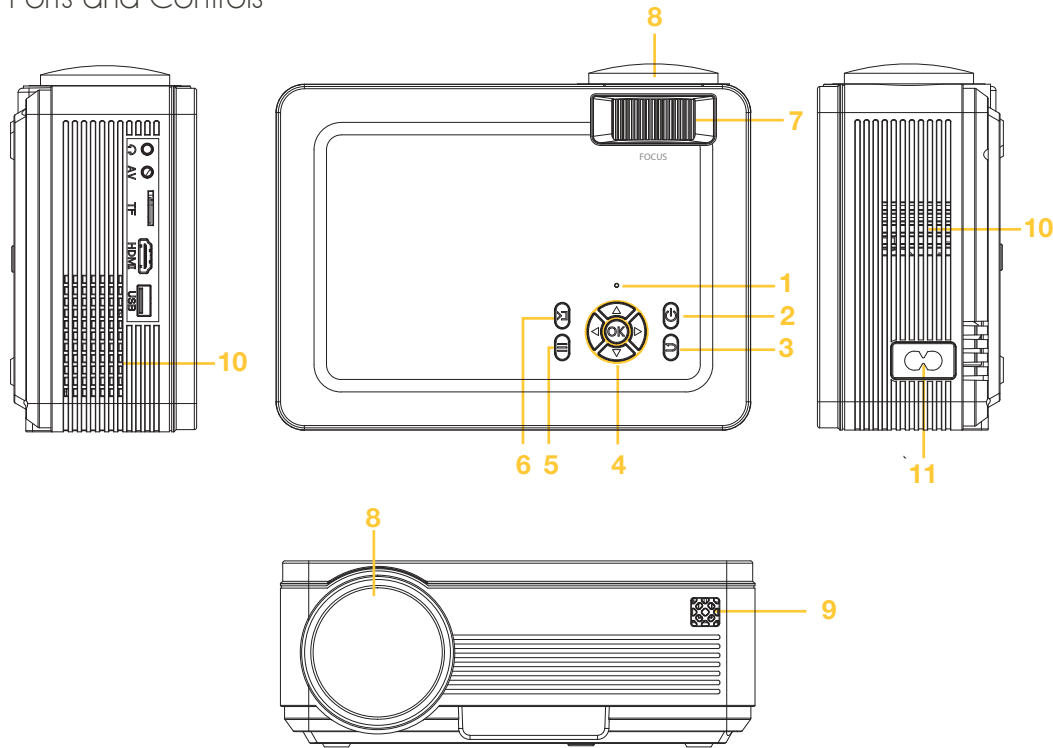





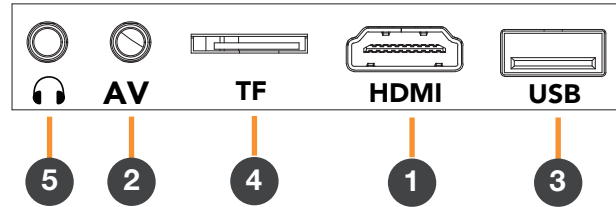
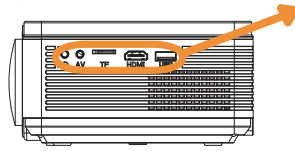

1. Power indicator
2. On / Off
3. Return
4. ▲/▼/◀/▶/◎
5. MENU
6. Home
7. Focal adjustment
8. Lens
9. IR sensor
10. Vent holes
11. Power input

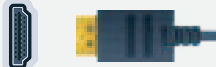
Product Overview cont.

Ports and Controls



1	HDMI IN Use a high-speed HDMI cable for best picture and sound quality.		SOUND PICTURE COMPUTER	All-digital connection between the projector and any HDMI device. Supports HD picture quality. Requires a HDMI cable (included). For Windows 10 computers, you can press the keyboard  + "P" button to quickly connect the projector.
2	AV IN		SOUND PICTURE	You can use this to connect your DVD player. Supports standard definition (SD) picture quality. Requires an AV adaptor cable (included) and AV cable (not included).
3	USB		MEDIA WIRE SCREEN UPGRADE	Playback media files stored on your USB storage device (supported file codecs and extensions may vary). Connect your iOS and Android smart phone for the wired screen. Update software of the projector..
4	TF/Micro SD		MEDIA	Playback media files stored on your TF(Micro SD) card (supported file codecs and extensions may vary).
5	HEADPHONE OUT		SOUND	Connect to your headphones, amplifier or audio device, using an AUX cable (not included).

Product Overview cont.

Remote Control

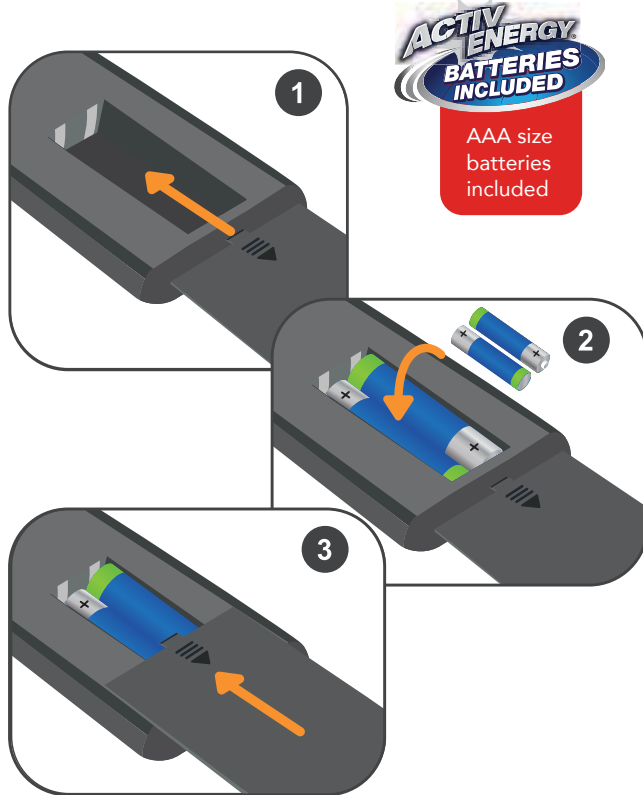

Setup

Insert two AAA size batteries according to the polarity markings (+/-) inside the compartment. Make sure the batteries are correctly aligned and properly pushed into place.



Precautions When Using Batteries

- Do not use old and new batteries together.
- Do not use different types of batteries (e.g. Manganese and Alkaline batteries) together.
- Remove the batteries from the control remote if you do not intend to use it for a long time.
- When discarding used batteries, follow any guidelines for recycling and disposal of batteries that apply in your local area.
- Keep batteries away from children and pets.
- Never throw batteries into a fire or expose them to extreme heat.

Product Overview cont.

Remote Control



Operation

Installation Method

The projector can be placed on the table or mounted on the ceiling to project the image according to the operating environment and requirements. Keep the projector at a height where its lens is axial symmetry to the screen. If this is not possible, use the keystone correction function to adjust the projection image.

Adjust the Projection Setting menu to flip the projection image direction after installed.

Projector Screen

Please choose projector screen with better gain, contrast and surface quality in creating the optimum projection experience.

Power On/Off

Connect to the power cable, press the power button on the unit or remote control to start the projector (indicator will glow blue); press it again to power Off (standby mode) the projector (indicator will glow red).

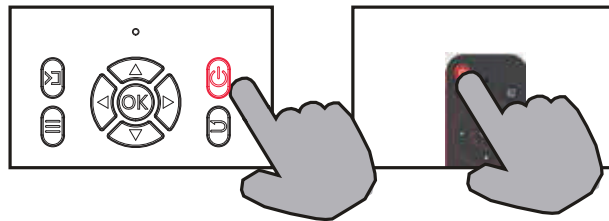
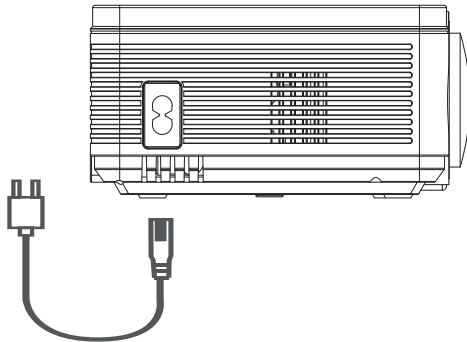

Operation cont.

Focus Adjustment

Adjust the focus wheel of the projector until the picture is clear (please keep the projection distance more than 1m, otherwise it will not focus correctly).



Keystone Correction

Adjust the Projection Setting menu to correct keystone of the projection image.



Picture Size Setting

Adjust the Picture Size setting to correct the display area and aspect ratio of the image.

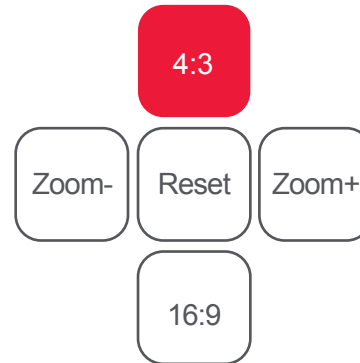

Operation cont.

Wired Screen

Connect iOS Device

1. Connect your iOS device to the projector USB port via the original iOS device charging cable.
2. Please click "Trust" when the iOS device shows a pop-up window.

Connect Android Device

1. Scan the QR code to download and Install the app.
2. Use a USB cable (supports data transferring) to connect your Android device to the projector.
3. Confirm to open the app in the pop-up window of your device.
4. Enter your device password if the app prompted to authenticate the connection.
5. Adjust Screen Mirroring Settings on the app to display full screen on projector.
6. To get a stable connection, some Android devices require selecting "Transfer Files" for screen mirroring.



Note:

To protect your privacy, some apps on your iOS / Android device may not allow to record / project audio and/or video content on the screen.

Distance for Projection

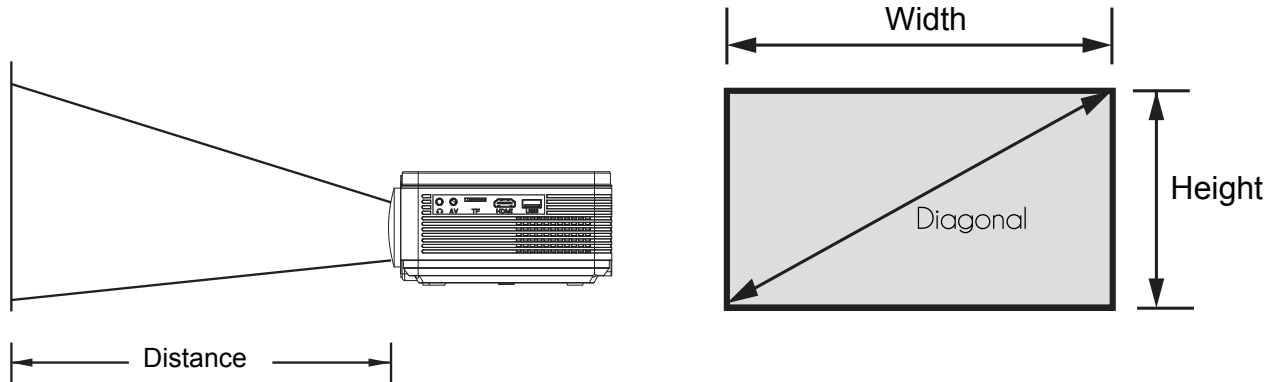

Distance from Projector	Width	Height	Diagonal
1.0m	0.69m	0.39m	32"
1.5m	1.10m	0.62m	50"
2.1m	1.55m	0.87m	70"
2.6m	2.00m	1.12m	90"
3.1m	2.42m	1.36m	110"
5.5m	4.60m	2.58m	208"

Troubleshooting

Problem	Solution
Projector won't turn on	<ul style="list-style-type: none">• Check the power cable is securely connected.• Press the power button on the remote control or the top of projector.
The projection screen is blurry	<ul style="list-style-type: none">• Please keep the projection distance above 1m and adjust the focus until the screen is clear.• Please choose projector screen with better gain, contrast and surface quality in creating the optimum projection experience.
Projector is connected to my laptop via HDMI port, but projector keeps “No signal”?	<ul style="list-style-type: none">• Please make sure your laptop is set to projection mode.• If it still fails, please try to connect the projector to other devices such as TV stick with the HDMI cable. If the connection is successful, the projector has no problem.• Please check the projection settings of your laptop.
No image showing on projection	<ul style="list-style-type: none">• Do not place objects between the projector and the screen.• Check HDMI, AV or phone cable is securely connected.
No sound from the projector	<ul style="list-style-type: none">• Make sure the source or the app is not muted.• Check that the plug is not inserted into the headphone port.• Increase the volume from the source.• Some apps on your iOS / Android device may not allow to record / project audio.

Lens Maintenance

The projector lens is a crucial component directly impacting picture definition and quality.

Ensure to keep the lens clean from excessive dust.

When cleaning, use a soft cotton cloth suitable for glass lenses.

Avoid using hard cloth or abrasives, as they can damage the lens surface.

Specifications

Power Supply	AC100-240V 50/60Hz 1.5A
Power Consumption	70W
Resolution	LCD Native resolution 1920 x 1080P
Projection Size	32"- 208"
Projection Distance	1m to 5.5m (Approx.)
Aspect Ratio	16:9 / 4:3
Brightness	180 lumens (when projection size is 60")
LED Lamp Lifetime	up to 30,000 hours
Keystone Correction	±15°
Speaker Output	3W (RMS)
Media Formats	MP3, JPEG, BMP, AVI, MPEG-1, MPEG-2, MPEG-4, MKV, TXT
Connectivity	1 x HDMI Input 1 x AV Input 1 x USB Port 1 x TF(Micro SD) Slot 1 x Headphone Output
Dimensions (L x W x H)	210 x 152 x 83mm
Net Weight	0.95Kg

For Technical and Warranty Support

PRODUCED IN CHINA FOR:

 **AUS 1300 002 534**

 **tempo.org/support**

Distributed by Tempo (Aust) Pty Ltd,
PO BOX 6097, North Sydney, NSW, 2059



Compliance and Responsible Disposal



Packaging

The packaging of your product has been selected from environmentally friendly materials and can usually be recycled. Please ensure these are disposed of correctly. Plastic wrapping can be a suffocation hazard for babies and young children, please ensure all packaging materials are out of reach and are safely disposed of. Please recycle these materials rather than throwing them away.

Product

At the end of its working life, do not throw this product out with your household rubbish. An environmentally friendly method of disposal will ensure that valuable raw materials can be recycled. Electrical and electronic items contain materials and substances which, if handled or disposed of incorrectly, could potentially be hazardous to the environment and human health.

Compliance

This product complies with the Australian Safety Standard AS/NZS 62368.1 to ensure the safety of the product.



BAUHN®

Warranty Information

The product is guaranteed to be free from defects in workmanship and parts for a period of 12 months from the date of purchase. Defects that occur within this warranty period, under normal use and care, will be repaired, replaced or refunded at our discretion, solely at our option with no charge for parts and labour. The benefits conferred by this warranty are in addition to all rights and remedies in respect of the product that the consumer has under the Competition and Consumer Act 2010 and similar state and territory laws.

Our goods come with guarantees that cannot be excluded under the Australian Consumer Law. You are entitled to a replacement or refund for a major failure and to compensation for any other reasonably foreseeable loss or damage. You are also entitled to have the goods repaired or replaced if the goods fail to be of acceptable quality and the failure does not amount to a major failure.





BAUHN®

Repair and Refurbished Goods or Parts Notice

Unfortunately, sometimes faulty products are manufactured, which need to be returned to the supplier for repair.

Please be aware that if your product is capable of retaining user-generated data (such as files stored on a computer hard drive, telephone numbers stored on a mobile telephone, songs stored on a portable media player, games saved on a games console or files stored on a USB memory stick) during the process of repair, some or all of your stored data may be lost. We recommend you save this data elsewhere prior to sending the product for repair.

You should also be aware that rather than repairing goods, we may replace them with refurbished goods of the same type or use refurbished parts in the repair process.

Please be assured though, refurbished parts or replacements are only used where they meet ALDI's stringent quality specifications.

If at any time you feel your repair is being handled unsatisfactorily, you may escalate your complaint. Please telephone us on 1300 002 534 or write to us at:

Tempo (Aust) Pty Ltd ABN 70 106 100 252
PO BOX 6097, North Sydney, NSW, 2059, Australia
Telephone: 1300 002 534 (Aust) Fax: (02) 8977 3765
Tempo Help Desk: 1300 002 534 (Aust)
(Operating Hours: Mon-Fri 8:30am-6pm; Sat 9am-6pm AEST)
Email: tempo.org/support

Notes

Online support

Visit bauhn.com.au for software updates to keep your product up-to-date, as well as the latest User Manual for information on the updated features.

Warranty returns

Should you for any reason need to return this product for a warranty claim, make sure to include all accessories with the product.

Product does not work?

If you encounter problems with this product, or if it fails to perform to your expectations, please contact our After Sales Support Centre on 1300 002 534.

ALDI guarantees that our products are developed to our stringent quality specifications. If you are not entirely satisfied with this product, please return it to your nearest ALDI store within 60 days from the date of purchase for a full refund or replacement, or take advantage of our after sales support by calling the supplier's Customer Service Hotline.



It will help you get the best out of your product.

Call After Sales Support

1300 002 534

Or visit tempo.org/support

AFTER SALES SUPPORT



 **AUS 1300 002 534**

 **tempo.org/support**

MODEL: AFHDP-0825

Sellable ID: 673542 08/2025

1

YEAR WARRANTY