

UNIVERSAL KEYPAD FAMILY

Stand-alone access control keypads



Visit website for available languages of this document.

DESCRIPTION

1. Door LED
2. Mode LED
3. Matrix keypad
4. Case screw (bottom of case)

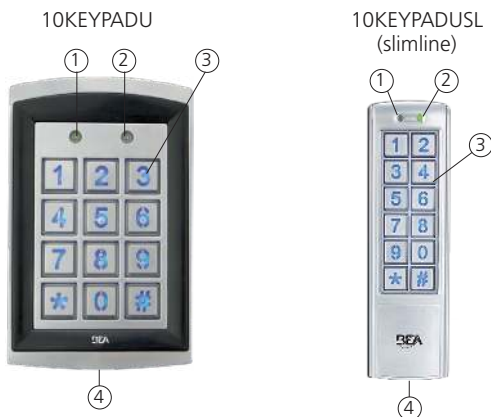

TECHNICAL SPECIFICATIONS

Supply voltage: 12 – 24 VAC/VDC

WARNING: Product will be damaged and warranty will be voided if supply voltage exceeds 30VDC or 24VAC. This product shall not be used with a BEA part number 1024VAC transformer or any standard, non-regulated 24VAC transformer as the measured voltage exceeds 24 VAC.

Standby current: ≤ 30 mA

Working current: ≤ 160 mA

Max user codes: 1100 (zone 1: 1000 users, zone 2: 100 users)

Relock time: 0 – 99 seconds

Output: 2 Form-C relays (free of potential change-over contact)
 Max. contact voltage: 42 VAC/VDC
 Max. contact current: 1 A (resistive)
 Max. switching power: 30 W (VDC) / 48 VA (VAC)

Cable length: 3 ft

Operating temperature: $-22 - 158$ °F

Operating humidity: 0 – 95% (non-condensing)

IP rating: IP66 (waterproof and dustproof)

Dimension: 10KEYPADU: 3.0" (W) x 4.7" (H) x 0.9" (D) – (76 mm x 120 mm x 22 mm)
 10KEYPADUSL: 1.7" (W) x 5.9" (H) x 0.95" (D) – (44 mm x 150 mm x 24 mm)

Certification: CE, RoHS

Backlight: Blue keypad illumination

*Specifications are subject to change without prior notice.
 All values measured in specific conditions.*

READ BEFORE BEGINNING INSTALLATION/PROGRAMMING/SET-UP

PRECAUTIONS



CAUTION

- ❑ Shut off all power going to header before attempting any wiring procedures.
- ❑ Maintain a clean and safe environment when working in public areas.
- ❑ Always check placement of all wiring before powering up to ensure that moving door parts will not catch any wires and cause damage to equipment.
- ❑ Ensure compliance with all applicable safety standards (i.e. ANSI A156.10) upon completion of installation.

MOUNTING



INSTALLATION TIPS

- Handle the equipment with care.
- Add threadlocker to all screws before installing.
- Firmly tighten screws.

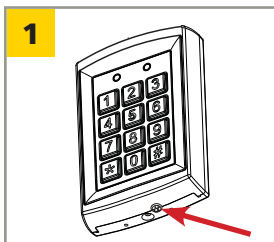

Using the supplied hex key, remove the backcase screw from the keypad bottom.

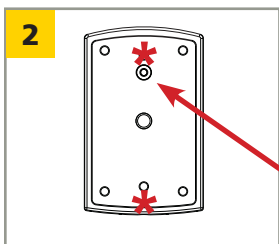

Use the drilling template and drill required holes.

For **surface** mounting, drill the 4 corner holes in the image.

For **single-gang box** mounting, drill the 2 holes marked with an asterisk in the image.

NOTE: Do not damage the tamper sensor.

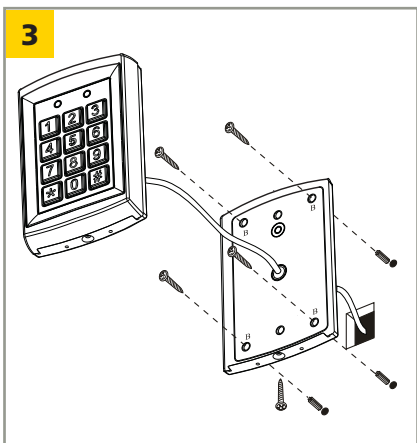

Mount backcase on the wall with provided screws.

Make sure to pull keypad cable through the center hole.

Keep keypad horizontal to the floor.

WIRING

Connect the wires based on the wiring diagram below.

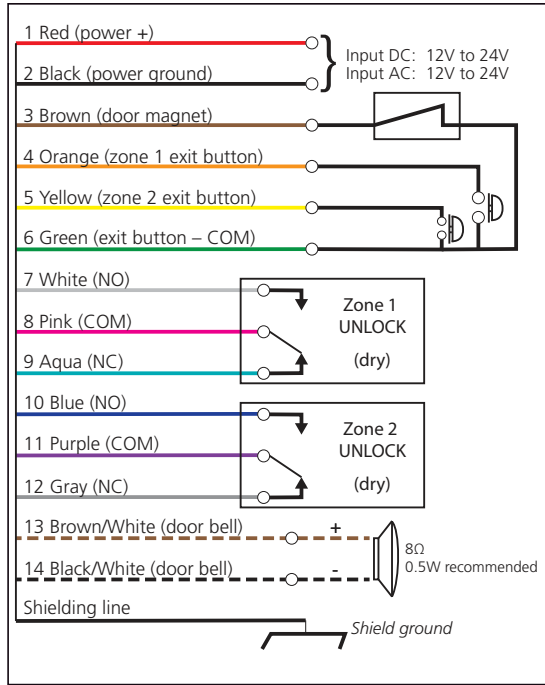

When wiring is complete, mount the keypad to the back cover by using the provided screws.

PROGRAMMING







PROGRAMMING TIPS













- If you forget the administration code, turn off the power, press and hold “#” key, and then turn the power back on. A short beep will be heard and the administration code has been restored back to 1234.
- If no buttons are pressed within 30 seconds while in “setup” mode, the device will turn back to normal function automatically. Mode LED turns green.
- If any incorrect key combinations are entered, a continuous beep will be heard.

PROGRAMMING (cont.)

GETTING STARTED

























	DOOR	MODE
ENTER SETUP MODE		
Enter the default administration code (1234) twice (i.e. 1234 + 1234) to enter "setup" mode. Mode LED will turn red and a long beep will be heard.		
Press the "#" key to exit "setup" mode. Mode LED will turn green.		

ADMIN CODES

	DOOR	MODE
CHANGE LENGTH OF ADMIN CODE		
<i>Changing the admin code length will delete all existing user codes.</i>		
<i>Changing the admin code length will reset the admin code back to a sequential number (similar to that in step 1a), consisting of the correct amount of digits (e.g. if the admin code length is changed to 6 digits, the admin code defaults to "123456").</i>		
Enter "setup" mode.		
Press the star (*) key and then "9". Mode LED will flash red.		
Press "0" and then "4". A short beep will sound. Mode LED will turn red.		
Enter the length of the admin code in digits, ranging from "2" to "6" ("2" is the minimum code length, and "6" is the maximum). <ul style="list-style-type: none">• one beep = admin code length successfully changed• three beeps = admin code length is equal to existing length		
Press "#" to exit "Admin code length setup" mode. Mode LED remains red.		
Press "#" again to exit "setup" mode. Mode LED turns green.		
MODIFY ADMIN CODE		
Enter "setup" mode.		
Press the star (*) key and then "3". Mode LED will flash red.		
Enter a new code, 2 – 6 digits (00 – 999999) twice to set the new admin code. Note: The number of digits must match the admin code length.		
Press "#" to exit "setup" mode. Mode LED turns green.		













PROGRAMMING (cont.)

USER CODES













	DOOR	MODE
ADD USER CODE TO ZONE 1 <i>(must be different from admin code)</i>		
Enter "setup" mode.		
Press the star (*) key and then "9". Mode LED will flash red.		
Press "0" and then "2". A short beep will sound. Mode LED will turn red.		
Enter a 3-digit number (000 – 999) to set the electronic location for the zone 1 user code. LED remains red, and a short beep will sound after entering the 3-digit number. <i>If the location is occupied, the door LED will illuminate red.</i>		
Enter the new user code. The user code must be the same length as the admin code. A long beep will sound. User code is successfully added. The new code will replace the existing code stored in the same location.		
Repeat the previous two steps to add more codes.		
Press "#" to exit "Add user code to zone 1" mode. Mode LED remains red.		
Press "#" again to exit "setup" mode. Mode LED turns green.		
NOTE: When zone 1 output relay is activated, the door indicator LED will turn green.		
ADD USER CODE TO ZONE 2 <i>(must be different from admin code and zone 1 user code)</i>		
Enter "setup" mode.		
Press the star (*) key and then "9". Mode LED will flash red.		
Press "0" and then "3". A short beep will sound. Mode LED will turn red.		
Enter a 2-digit number (00 – 99) to set the electronic location for the zone 2 user code. LED remains red, and a short beep will sound after entering the 2-digit number. <i>If the location is occupied, the door LED will illuminate red.</i>		
Enter the new user code. The user code must be the same length as the admin code. A long beep will sound. User code is successfully added. The new code will replace the existing code stored in the same location.		
Repeat the previous two steps to add more codes.		
Press "#" to exit "Add user code to zone 2" mode. Mode LED remains red.		
Press # again to exit "setup" mode. Mode LED turns green.		
NOTE: When zone 2 output relay is activated, the door indicator LED will turn red.		

PROGRAMMING (cont.)

USER CODES (cont.)

	DOOR	MODE
REMOVE ONE USER CODE		
Enter "setup" mode.		
Enter the location of the user code to be deleted (three digits). Mode LED will flash red.		
Press the star (*) key twice to delete. Door LED turns green. Mode LED will flash red.		
Press "#" twice to end programming. Mode LED turns green.		
REMOVE ALL USER CODES		
Enter "setup" mode.		
Press the star (*) key and then "8". Mode LED will flash red.		
Press "8" twice. A long beep will sound. Mode LED will flash red.		
Press "#" again to exit "setup" mode. Mode LED turns green.		

UNLOCKING TIMES













	DOOR	MODE
SET UNLOCKING TIME FOR ZONE 1		
Enter "setup" mode.		
Press the star (*) key and then "1". Mode LED will flash red.		
Enter a 2-digit number (00 – 99) for the "unlock time" value. <ul style="list-style-type: none"> "00" = sets "unlock time" to toggle mode ("00" to both open and close the door) "01" to "99" = "unlock time" in seconds "01" = default 		
After entering the "unlock time" number, a long beep will sound and the mode LED turns red.		
Press "#" to exit "setup" mode. Mode LED turns green.		
SET UNLOCKING TIME FOR ZONE 2		
Enter "setup" mode.		
Press the star (*) key and then "5". Mode LED will flash red.		
Enter a 2-digit number (00 – 99) for the "unlock time" value. <ul style="list-style-type: none"> "00" = sets "unlock time" to toggle mode ("00" to both open and close the door) "01" to "99" = "unlock time" in seconds "01" = default 		
After entering the "unlock time" number, a long beep will sound and the mode LED turns red.		
Press "#" to exit "setup" mode. Mode LED turns green.		

PROGRAMMING (cont.)

BUZZER

FACTORY DEFAULT = ON













DOOR MODE

TURN ON BUZZER		
Enter "setup" mode.		
Press the star (*) key and then "2". Mode LED will flash red.		
Press "0" and then "3". Mode LED will turn red.		
Press "#" again to exit "setup" mode. Mode LED turns green.		
TURN OFF BUZZER		
Enter "setup" mode.		
Press the star (*) key and then "2". Mode LED will flash red.		
Press "0" and then "4". Mode LED will turn red.		
Press "#" again to exit "setup" mode. Mode LED turns green.		
NOTE: Buzzer will still sound (for 1 second) after a valid access code is entered.		

BACKLIGHT

FACTORY DEFAULT = ON

DOOR MODE

TURN ON BACKLIGHT		
Enter "setup" mode.		
Press the star (*) key and then "2". Mode LED will flash red.		
Press the star (*) key and then "2". Mode LED will turn red.		
Press "#" again to exit "setup" mode. Mode LED turns green.		
TURN OFF BACKLIGHT (10KEYPADSU only)		
Enter "setup" mode.		
Press the star (*) key and then "2". Mode LED will flash red.		
Press the star (*) key and then "1". Mode LED will turn red.		
Press "#" again to exit "setup" mode. Mode LED turns green.		
NOTE: Backlight will illuminate after any button is pressed, and will turn off after 45 seconds of no activity.		

DOOR BELL

PROGRAM A DOOR BELL

Connect an external speaker (8Ω, 0.5w) to brown/white and black/white wires of this device.













Press the star (*) key and the external speaker rings as a door bell.

OPTIONAL PROGRAMMING







TAMPER ALARM

This feature allows a built-in buzzer to activate if the keypad is removed from the wall. The alarm will stop automatically in 60 seconds or if the admin code is entered before the 60-second timeout.

FACTORY DEFAULT: OFF

	DOOR	MODE
TURN ON TAMPER ALARM		
To turn on the tamper alarm feature, enter "setup" mode.		
Press the star (*) key and then "6". Mode LED will flash red.		
Press "0" and then "2". A long beep will sound. Mode LED will turn red.		
Press "#" again to exit "setup" mode. Mode LED turns green.		
TURN OFF TAMPER ALARM		
To turn off the tamper alarm, enter "setup" mode.		
Press the star (*) key and then "6". Mode LED will flash red.		
Press "0" and then "1". A long beep will sound. Mode LED will turn red.		
Press "#" again to exit "setup" mode. Mode LED turns green.		

FACTORY RESTORE

	DOOR	MODE
RESTORE TO FACTORY DEFAULTS (clears all user codes, resets admin code length and admin code)		
Enter "setup" mode.		
Press the star (*) key and then "8". Mode LED will flash red.		
Press "9" twice. A long beep will sound. Mode LED will flash red.		
Press "#" twice to exit "setup" mode. Mode LED turns green.		

USER OPERATION

Simply enter the user code provided to you.

If 3 invalid consecutive keyboard input entries occur, the keypad will be disabled for 60 seconds.

BEA, INC. INSTALLATION/SERVICE COMPLIANCE EXPECTATIONS

BEA Inc., the sensor manufacturer, cannot be held responsible for incorrect installations or incorrect adjustments of the sensor/device; therefore, BEA Inc. does not guarantee any use of the sensor/device outside its intended purpose.

BEA Inc. strongly recommends that installation and service technicians be AAADM-certified for pedestrian doors, IDA-certified for doors/gates, and factory-trained for the type of door/gate system.

Installers and service personnel are responsible for executing a risk assessment following each installation/service performed, ensuring that the sensor/device system performance is compliant with local, national, and international regulations, codes, and standards.

Once installation or service work is complete, a safety inspection of the system shall be performed and documented per the manufacturer's recommendations or industry guidelines. Examples of compliance may apply to ANSI 156.10, ANSI 156.19, ANSI/DASMA 102, ANSI/DASMA 107, UL294, UL325, and International Building Code.

Tech Support: 1-800-407-4545 | Customer Service: 1-800-523-2462
General Tech Questions: techservices-us@BEAsensors.com | www.BEAsensors.com

