

User Manual

XENYX 1002B

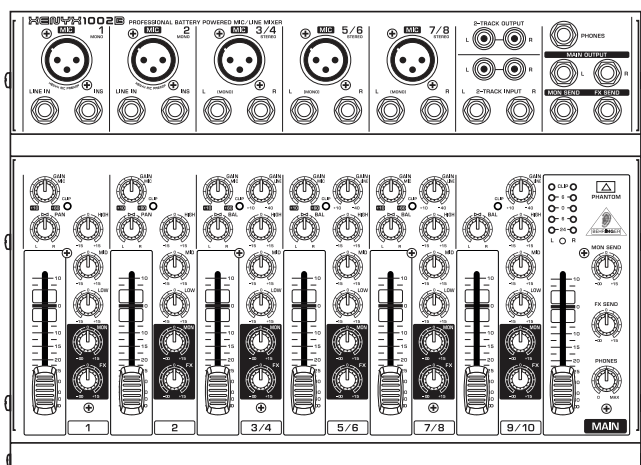

**Ultra low-noise design,
10-input, 2-bus mic/line mixer
with optional battery
operation**

Thank you

Thank you for choosing the XENYX 1002B 10 input mixer. This mixer is packed with features like ultra low-noise XENYX mic preamps, neo-classic "British" 3-band EQs, and stereo channels that allow simultaneous mic and line input use, as well as both monitor and FX sends on each channel. The 1002B can also operate on battery power, a unique feature that allows you to record or perform on the go or outdoors. The 1002B delivers everything you expect from a powerful, small-format mixer. From broadcasting and video dubbing to full band performance and recording, this versatile piece of gear works wonders in a variety of applications.

Table of Contents

Thank you	1
Important Safety Instructions	2
1. Before You Get Started	3
2. Audio Connections	4
3. Controls and Connectors	5
4. Gain Setting	6
5. Applications	8
6. Specifications	9
Limited warranty	11
Legal Disclaimer	12

This manual is available in English, German, Spanish and Chinese. Download them by going to the appropriate product page at:

www.behringer.com



Important Safety Instructions



Terminals marked with this symbol carry electrical current of sufficient magnitude to constitute risk of electric shock. Use only high-quality commercially-available speaker cables with ¼" TS plugs pre-installed. All other installation or modification should be performed only by qualified personnel.



This symbol, wherever it appears, alerts you to the presence of uninsulated dangerous voltage inside the enclosure - voltage that may be sufficient to constitute a risk of shock.



This symbol, wherever it appears, alerts you to important operating and maintenance instructions in the accompanying literature. Please read the manual.



Caution

To reduce the risk of electric shock, do not remove the top cover (or the rear section). No user serviceable parts inside. Refer servicing to qualified personnel.



Caution

To reduce the risk of fire or electric shock, do not expose this appliance to rain and moisture. The apparatus shall not be exposed to dripping or splashing liquids and no objects filled with liquids, such as vases, shall be placed on the apparatus.



Caution

These service instructions are for use by qualified service personnel only. To reduce the risk of electric shock do not perform any servicing other than that contained in the operation instructions. Repairs have to be performed by qualified service personnel.

- ⑥ Clean only with dry cloth.
 - ⑦ Do not block any ventilation openings. Install in accordance with the manufacturer's instructions.
 - ⑧ Do not install near any heat sources such as radiators, heat registers, stoves, or other apparatus (including amplifiers) that produce heat.
 - ⑨ Do not defeat the safety purpose of the polarized or grounding-type plug. A polarized plug has two blades with one wider than the other. A grounding-type plug has two blades and a third grounding prong. The wide blade or the third prong are provided for your safety. If the provided plug does not fit into your outlet, consult an electrician for replacement of the obsolete outlet.
 - ⑩ Place the power cord so that it is protected from being walked on and sharp edges. Be sure that the power cord is protected particularly at plugs, convenience receptacles and the point where it exits from the apparatus.
 - ⑪ The apparatus shall be connected to a MAINS socket outlet with a protective earthing connection.
 - ⑫ Where the MAINS plug or an appliance coupler is used as the disconnect device, the disconnect device shall remain readily operable.
 - ⑬ Only use attachments/accessories specified by the manufacturer.
 - ⑭ Use only with the cart, stand, tripod, bracket, or table specified by the manufacturer, or sold with the apparatus. When a cart is used, use caution when moving the cart/apparatus combination to avoid injury from tip-over.
 - ⑮ Unplug this apparatus during lightning storms or when unused for long periods of time.
 - ⑯ Refer all servicing to qualified service personnel. Servicing is required when the apparatus has been damaged in any way, such as power supply cord or plug is damaged, liquid has been spilled or objects have fallen into the apparatus, the apparatus has been exposed to rain or moisture, does not operate normally, or has been dropped.
- ① Read these instructions.
 - ② Keep these instructions.
 - ③ Heed all warnings.
 - ④ Follow all instructions.
 - ⑤ Do not use this apparatus near water.

1. Before You Get Started

1.1 Shipment

Your XENYX 1002B was carefully packed at the factory and the packaging is designed to protect the unit from rough handling. Nevertheless, we recommend that you carefully examine the packaging and its contents for any signs of physical damage which may have occurred during transit.

- ◆ If the unit is damaged, please do NOT return it to BEHRINGER, but notify your dealer and the shipping company immediately. Otherwise, claims for damage or replacement may not be granted.
- ◆ We recommend that you use a flight case, so as to give your power mixer optimum protection during use or transport.
- ◆ Always use the original packing carton to prevent damage during storage or transport.
- ◆ Make sure that children cannot play unsupervised with the device or its packaging.
- ◆ Please ensure proper disposal of all packing materials.

1.2 Online registration

Please do remember to register your new BEHRINGER equipment right after your purchase by visiting www.behringer.com (alternatively www.behringer.de) and kindly read the terms and conditions of our warranty carefully.

Should your BEHRINGER product malfunction, our goal is to have it repaired as quickly as possible. To arrange for warranty service, please contact the retailer from whom the equipment was purchased. Should your BEHRINGER dealer not be located in your vicinity, you may directly contact one of our subsidiaries. Corresponding contact information is included in the original equipment packaging (Global Contact Information/European Contact Information). Should your country not be listed, please contact the distributor nearest you. A list of distributors can be found in the support area of our website (www.behringer.com). Registering your purchase and equipment with us helps us process your repair claims quicker and more efficiently.

Thank you for your cooperation!

1.3 Basic Operation

The XENYX 1002B is easy to use. Simply follow these steps to achieve the best possible sound:

1. Plug the included power cable into the back of the mixer. Plug the other end of the cable into a mains outlet. **DO NOT** turn the mixer on yet.
2. Make all appropriate audio connections:
 - Connect microphones to the MIC jacks using XLR cables.
 - Connect line-level sources to the LINE IN jacks using ¼" TS cables.
 - Connect stereo sources (keyboard, drum machine) to one of the stereo LINE IN jacks using a pair of ¼" TS cables.
 - Connect a CD player to the 2 TRACK INPUT using ¼" or RCA cables.
 - See Applications chapter for more details and options.
3. Connect a monitoring source or speaker system. You may connect powered studio monitors, powered loudspeakers or a power amp to the MAIN OUTPUT jacks. You may also connect a pair of headphones to the PHONES jack. Leave powered speakers and/or power amps turned off until the mixer has been powered on.
4. Turn all PAN/BAL and EQ knobs to their center (12 o'clock) position. Set all other knobs and faders all the way down/off.
5. Once all connections have been made, you may turn the mixer on.
6. After the mixer is turned on, you may also turn the speakers or power amp on.
7. Set the input gain level for each channel using the GAIN knob. While testing the audio source, turn the GAIN knob as high as possible without allowing the CLIP LED to light. See the Gain Setting section for details.
8. Raise the MAIN fader to 0. You may adjust it further as you begin to set levels.
9. Adjust all channel volume faders until you achieve a balanced mix.
10. Make sure that the channel CLIP LEDs and MAIN CLIP LEDs do not light frequently. If this happens, adjust the respective GAIN or MAIN fader accordingly.
11. Congratulations! You have now set up a basic mix! The 1002B offers many other cool features as well, so continue through the manual to make the most out of this powerful little mixer.

2. Audio Connections

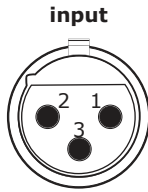

1 = ground/shield
2 = hot (+ve)
3 = cold (-ve)

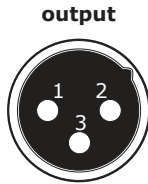

For unbalanced use, pin 1 and pin 3 have to be bridged

Balanced use with XLR connectors

Fig. 2.1: XLR Balanced

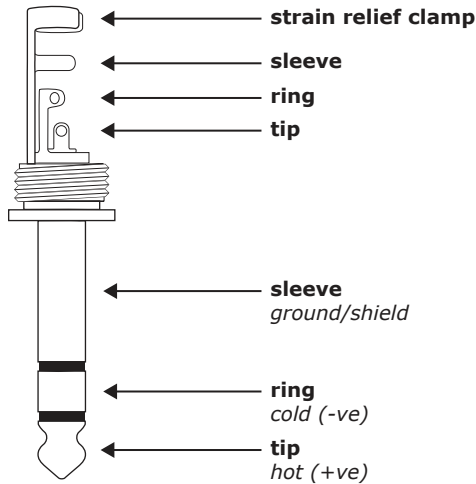

For connection of balanced and unbalanced plugs, ring and sleeve have to be bridged at the stereo plug.

Balanced 1/4" TRS connector

Fig. 2.2: 1/4" Balanced

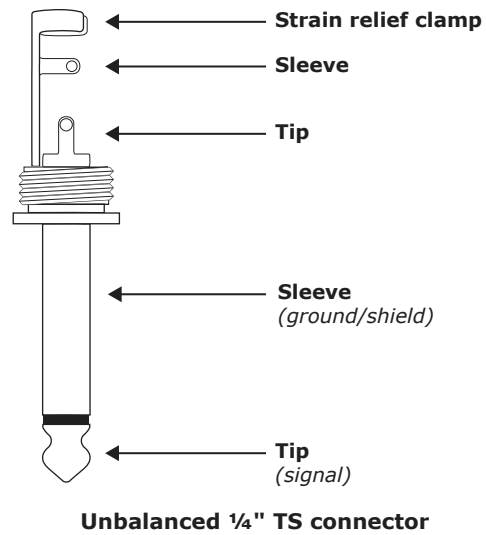

Fig. 2.3: 1/4" Unbalanced

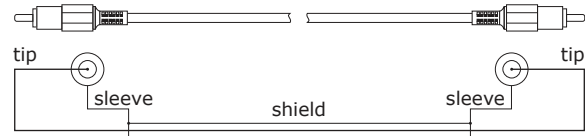
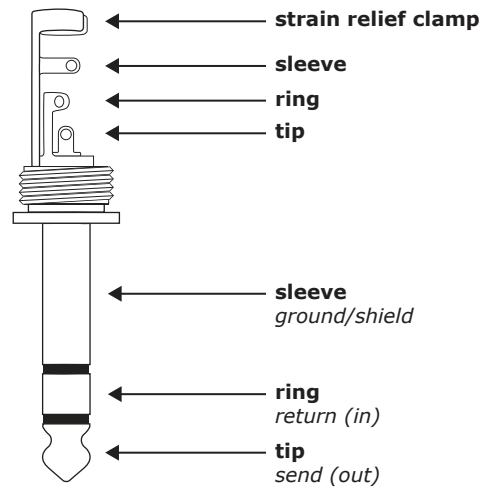

Fig. 2.4: RCA



Connect the insert send with the input and the insert return with the output of the effects device.

Insert send return 1/4" TRS connector

Fig. 2.5: Insert cable

3. Controls and Connectors

3.1 Front Panel

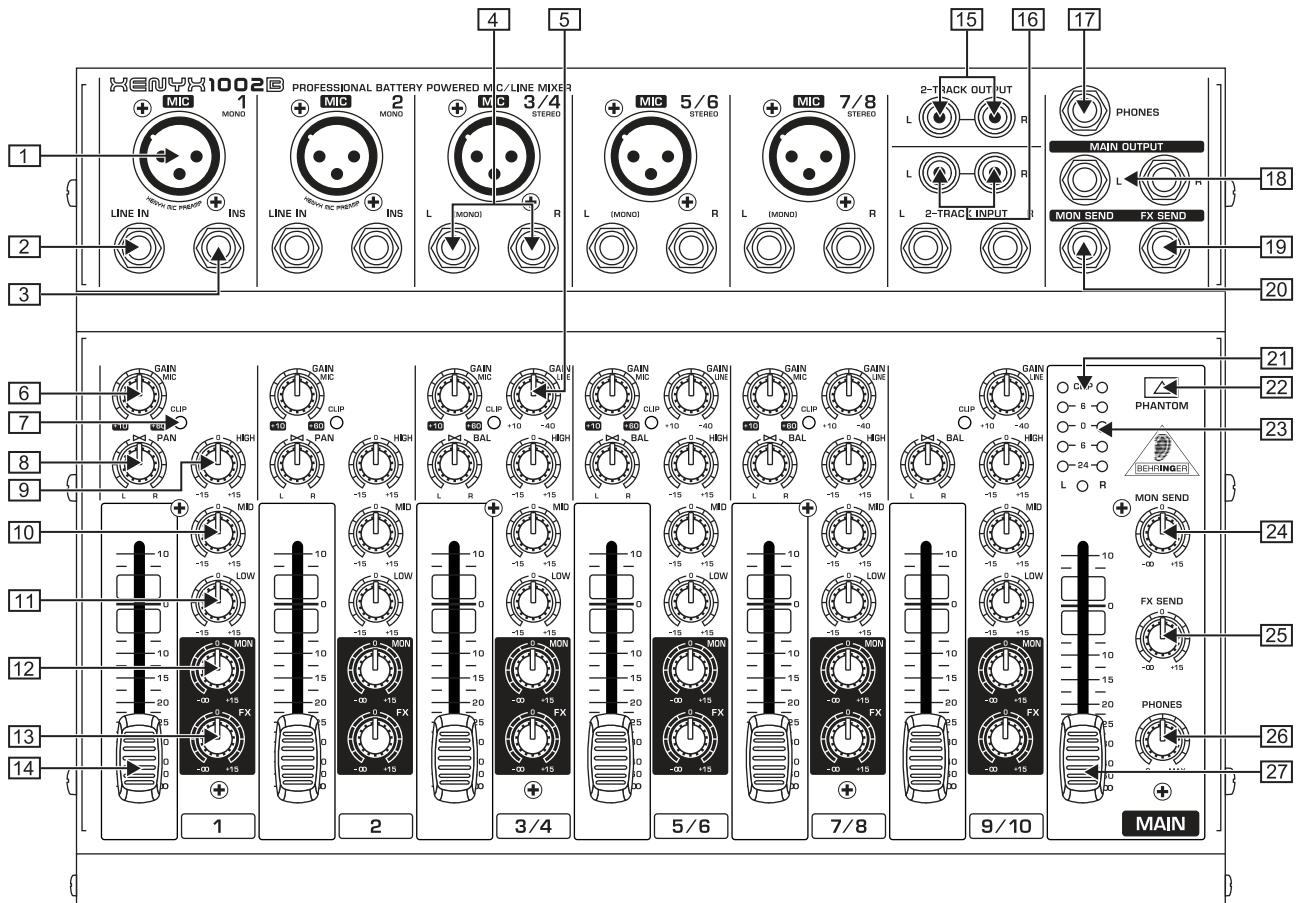

- ① **MIC** – Plug a microphone into this input using an XLR cable.
- ② **LINE IN** – Plug a line-level source into this jack using a ¼" TS or TRS cable.
- ③ **INS(ERT)** – Plug an external dynamic processor into this jack using a TRS to dual TS cable. You may also use the INSERT jack as a pre-EQ/pre-fader send by plugging in a ¼" TS cable part way to the first click.
- ④ **STEREO LINE IN** – Plug in a stereo source using two ¼" TS cables, or a single line-level source using the left input jack only.
- ⑤ **GAIN LINE** – Adjusts STEREO LINE IN sensitivity, also known as “gain setting.”
- ⑥ **GAIN MIC** – Adjusts MIC input sensitivity, also known as “gain setting.”
- ⑦ **CLIP** – Lights when preamp begins to overload.
- ⑧ **PAN/BAL** – Adjusts the left-to-right positioning of the channel in the stereo field.
- ⑨ **HIGH** – Adjusts frequencies above 10 kHz by +/- 15 dB.
- ⑩ **MID** – Adjusts frequencies peaking at 700 Hz by +/- 15 dB.
- ⑪ **LOW** – Adjusts frequencies below 50 Hz by +/- 15 dB.
- ⑫ **MON** – Adjusts the amount of signal sent to the MON SEND jack. This signal is sent pre-fader.
- ⑬ **FX** – Adjusts the amount of signal sent to the FX SEND jack. This signal is sent post-fader.
- ⑭ **CHANNEL FADER** – Adjusts the channel volume in the main mix.
- ⑮ **2-TRACK OUTPUT** – Connect to the inputs of recording device using RCA cables.
- ⑯ **2-TRACK INPUT** – Connect to outputs of CD, tape or MP3 player using RCA or ¼" cables.
- ⑰ **PHONES** – Connect a pair of headphones with a ¼" TRS plug.

- 18 **MAIN OUTPUT** – Connect to the inputs of a power amp or powered speakers using ¼" TS cables.
- 19 **FX SEND** – Connect to the input of an external effects device using a ¼" TS cable.
- 20 **MON SEND** – Connect to the input of a powered monitor or monitor power amp using a ¼" TS cable.
- 21 **VU CLIP** – Lights when the MAIN OUTPUT signal begins to overload.
- 22 **PHANTOM** – Sends 23V of power to the XLR MIC inputs for use with condenser microphones. When used with batteries, 18V of power is supplied.
- 23 **VU METER** – Displays the MAIN OUTPUT signal level.
- 24 **MON SEND** – Adjusts the output at the MON SEND jack.
- 25 **FX SEND** – Adjusts the output at the FX SEND jack.
- 26 **PHONES** – Adjusts the output at the PHONES jack.
- 27 **MAIN FADER** – Adjusts the overall output of the mixer through the MAIN OUTPUTS. It also affects the signal at the PHONES out and 2-TRACK OUTPUT.

3.2 Rear Panel

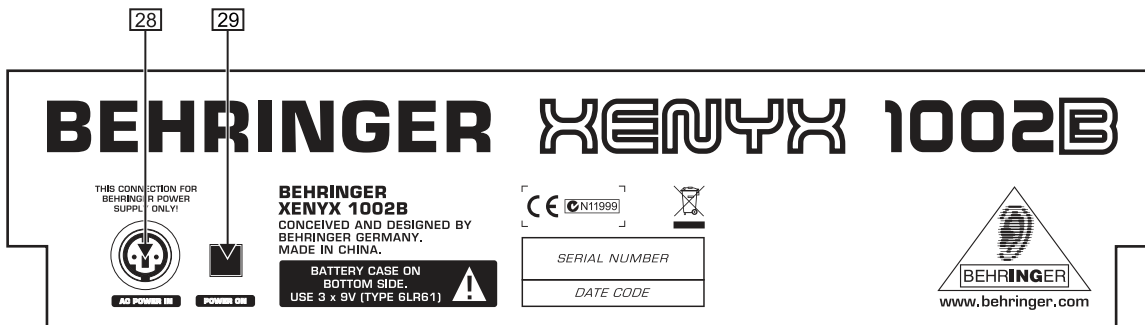

- 28 **AC POWER IN** – Connect the mains power cable into this input.
- 29 **POWER ON** – Turns the mixer’s power on and off.

4. Gain Setting

It is very important to set each channel’s GAIN knob correctly in order to get the maximum amount of signal headroom and least amount of noise possible. Setting the GAIN too low could make that channel too quiet to mix properly, while setting it too high will cause clipping and distortion. Stereo channels 3/4, 5/6 and 7/8 allow the MIC and LINE inputs to be used in parallel thanks to the dedicated GAIN knobs for each input. Follow these instructions to set the gain for each channel and situation:

- Plug the audio source into the channel input (XLR or ¼").
- Sing into the microphone or play the line-level source at the volume you will ultimately use during recording or performance. If you set the gain for a vocal mic by saying “check” into it, this gain setting will probably not be as loud as the actual vocal performance. Setting the gain this way will lead you to set the gain too high, which may cause the extra loud vocal performance to overload and distort. Likewise, if checking a mic that will record a saxophone, make sure the performer plays close to the mic while setting the gain. For keyboards, do not change the output volume of the keyboard after the mixer’s gain has been set.
- Turn the GAIN knob clockwise until the red CLIP LED lights

- up. This means the channel has begun to overload (too much signal is allowed in).
- Turn the GAIN knob counterclockwise a small amount, then sing or play again. Ideally, the GAIN knob should be set as high as possible while allowing the CLIP LED to only light occasionally, if at all.

If you must use both the MIC and LINE inputs on channels 3/4, 5/6, or 7/8, you can adjust the gain setting for each source individually thanks to the dedicated GAIN knobs. The channel fader affects the level of both sources, so achieving a good balance between the 2 inputs can be tricky.

- Set the gain for the MIC input using the GAIN MIC as described above.
- Set the gain for the LINE input(s) using the GAIN LINE as described above.
- Both GAIN knobs share the same CLIP LED, so when both sources are in use at the same time, neither input should cause the LED to light. If this happens, turn each GAIN knob down one at a time to determine which is overloading.
- Raise the channel fader so that both sources are audible in the overall mix. Ideally, they will already be balanced and not require further adjustment.
- If one source is too quiet with the fader turned up, turn the louder source’s GAIN knob down a bit, then raise the fader to the appropriate level. DO NOT simply turn the quiet source’s GAIN knob up until it is loud enough, as this will likely cause clipping and distortion.

4.1 Using External Effects

The 1002B lets you use external effects processors to add a touch of reverb, delay, or other effects to various channels. Use the channel FX knobs, FX SEND knob and FX SEND jack to send a portion of the signal from several channels to an effects processor. You can insert the “wet” signal back into the mix through one of the stereo channels. The FX signal from each channel is sent “post-fader,” meaning that as you change the channel’s volume, you also change how much of that channel’s signal is sent to the effects processor. This ensures that the mix of wet and dry signal remains the same as you adjust the channel volume. Follow these steps to incorporate external effects in your mix:

- Connect a ¼" TS cable from the FX SEND jack to the input of the effects processor.
- If you would like the effects to operate in stereo, connect ¼" cables from the left and right outputs of the processor to one of the stereo input channels on the 1002B.
- For mono operation, most processors return a mono signal through the left output. This mono signal should then be routed into the left input on one of the mixer channels. If possible, use channel 9/10 since it only allows line inputs.
- Turn the FX SEND knob to the center (12 o'clock) position.
- Turn the channel FX knob up for each source to which you would like to apply effects. For example, you can add a lot of reverb to a vocal mic, while only adding a small amount to a snare drum. This will just be a preliminary setting as you will not be able to hear the effect yet. Keep the knobs around the center position; you will fine-tune them shortly.
- Adjust the input gain for the channel receiving the output from the effects processor. (See the Gain Setting section for details.)
- Turn the channel fader up to 0 on the channel receiving the signal back from the processor. **DO NOT** turn the FX knob on that channel up at all! Your sound system will become haunted with screaming banshees.
- You should now hear the selected effect on the channels that are sending signal to the processor. Adjust the channel FX knobs to get the effect mix just right.
- NOTE: The processor will likely have its own VU meters to monitor the incoming signal level. If the processor’s meter begins clipping, turn down the FX SEND knob on the 1002B. *See the Applications section for details.*

4.2 Creating a Monitor Mix

For live applications, audio engineers often send different mixes to the audience and to the performing musicians. To allow this, the 1002B is equipped with a dedicated monitor send bus. Each channel features a MON knob that sends a “pre-fader” signal to the MON OUT jack, allowing the channel’s volume fader to be adjusted without affecting the monitor mix. The signal can also be used as a second effects send. Follow these steps to set up a basic monitor mix:

- Make sure the powered monitor speaker or power amp is turned off. Connect a ¼" TS cable from the MON OUT jack to the powered speaker or power amp.
- Turn on the powered speaker or power amp, and then turn the volume up about half way.
- Turn the MON SEND knob to the center (12 o'clock) position. This setting may need to be adjusted later depending on volume requirements.
- As the musicians begin to play, turn each channel’s MON knob up slowly until each source is audible in the monitor mix.
- It may take some time to get a balanced mix that all the musicians are happy with. If possible, avoid turning a channel’s MON knob much past the center position. Do not point the monitor speakers directly at a microphone, as this will likely cause feedback.

See the Applications section for details.

As previously stated, the MON SEND jack can also be used as a second effects send. This application requires a similar setup to the normal effects send, but since the signal from each channel is sent pre-fader using the MON knob, adjustments to the channel’s volume will affect the mix of wet and dry effect signal. Therefore, if you alter a channel’s volume during the performance, you must also adjust that channel’s MON knob.

- NOTE: When using the MON SEND for effects, if you neglect to change a channel’s MON knob while turning that channel’s volume fader all the way down, you will still hear the effected signal coming through the mix. This problem happens because the signal routes “pre-fader,” but the normal FX SEND bus will not experience this issue.

4.3 Battery Installation

The 1002B can be powered by three 9V batteries. This feature allows you, for example, to capture a high-quality recording while sitting on the beach with your laptop. You're no longer tethered by an electrical outlet. You can still record with condenser mics thanks to the 18V of phantom power supplied by two of the batteries. Follow these steps to install the batteries:

- Open the battery compartment located on the underside of the mixer. You will need to remove a small screw with a Phillips screwdriver.
- Slide the compartment cover out. There are slots for three batteries inside the compartment.
- Insert the batteries so that the + and – poles are in the correct position.
- Replace the cover and tighten the screw.

The battery power will last approximately four hours using high-quality alkaline batteries.

5. Applications

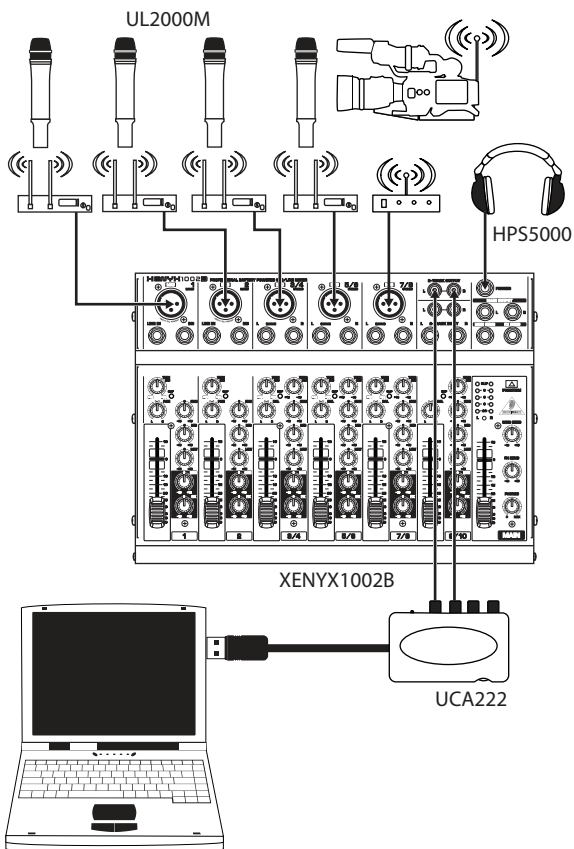

Fig.5.1: Field Recording

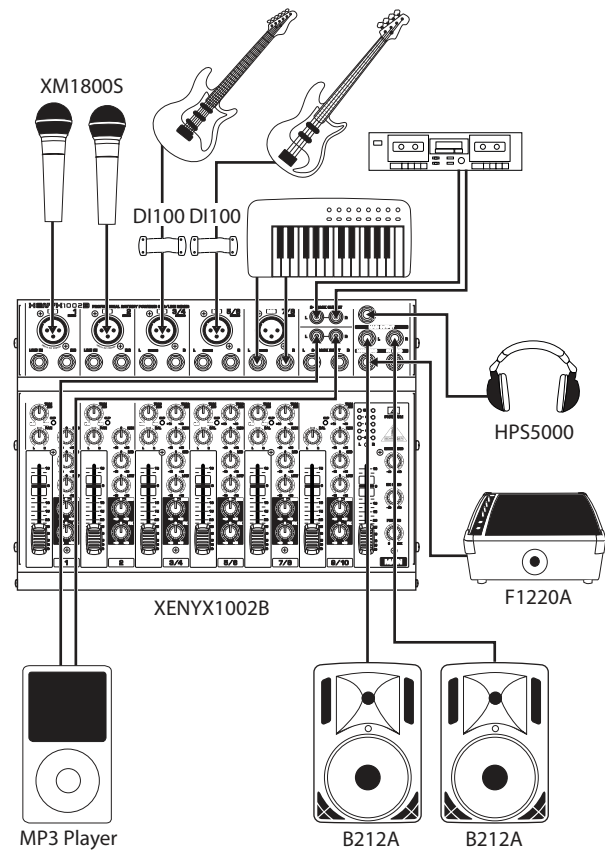

Fig.5.2: Live Small Combo

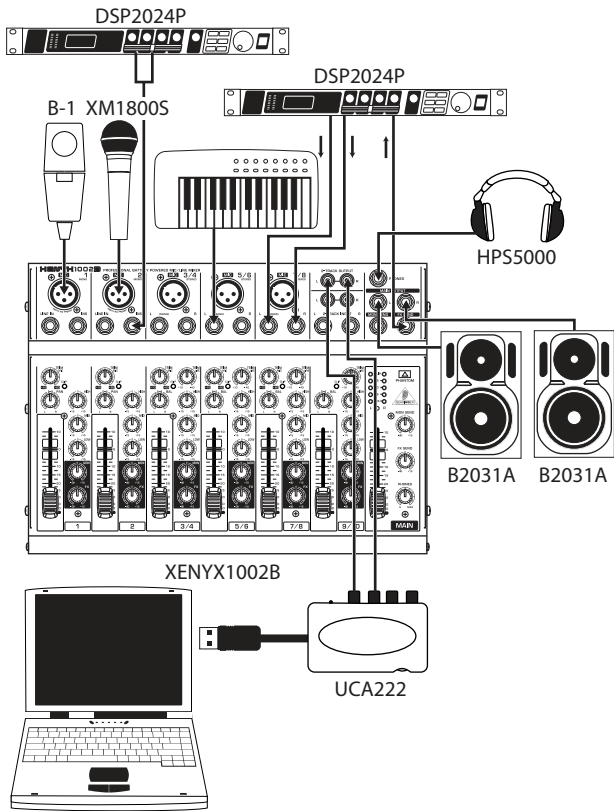

Fig.5.3: Computer Recording

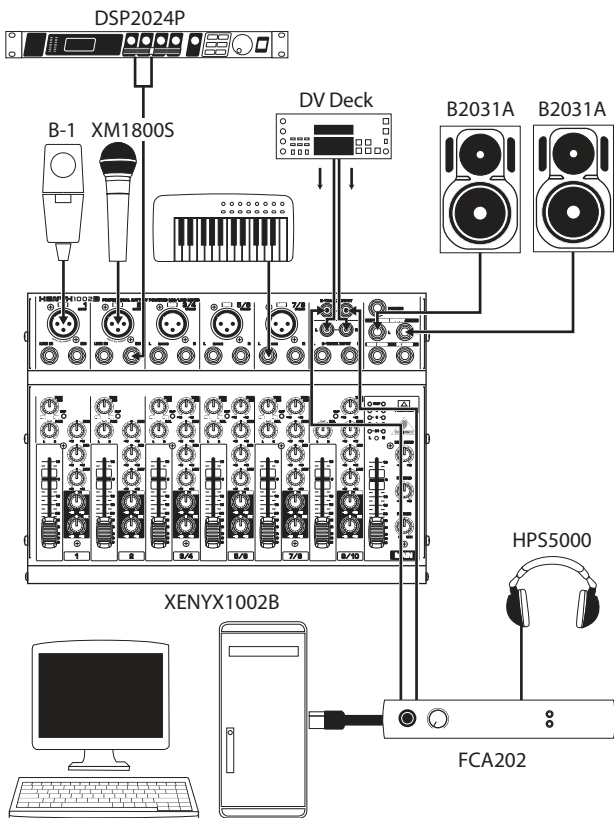

Fig.5.4: Video Editing

6. Specifications

Mono inputs

Microphone inputs (XENYX Mic preamp)

Type	XLR connector, electronically balanced, discrete input circuit
------	----------------------------------------------------------------

Mic E.I.N.1 (20 Hz - 20 kHz)

@ 0 Ω source resistance	-134 dB 135.7 dB A-weighted
@ 50 Ω source resistance	-131 dB 133.3 dB A-weighted
@ 150 Ω source resistance	-129 dB 130.5 dB A-weighted
Frequency response (-1 dB)	<10 Hz - 160 kHz (-1 dB)
Frequency response (-3 dB)	<10 Hz - 200 kHz (-3 dB)
Gain range	+14 dB to +60 dB
Max. input level	+12 dBu @ +10 dB GAIN
Impedance	2.6 k Ohms balanced
Signal-to-noise ratio	120 dB A-weighted (0 dBu In @ +22 dB GAIN)
Distortion (THD+N)	0.005% / 0.004% A-weighted

Line input

Type	1/4" TRS jack, electronically balanced
Impedance	20 k Ohms balanced, 10 k Ohms unbalanced
Gain range	-10 dB to +40 dB
Max. input level	+22 dBu @ 0 dB GAIN

Frequency response (Mic In → Main Out)

<10 Hz - 90 kHz (-1 dB)	+0 dB / -1 dB
<10 Hz - 160 kHz (-3 dB)	+0 dB / -3 dB

Stereo inputs

Type	2 x 1/4" TRS jack, balanced
Impedance	20 k Ohms balanced, 10 k Ohms unbalanced
Gain range	-20 dB to +20 dB
Max. input level	+22 dBu @ 0 dB GAIN

CD/Tape In

Type	RCA connector
Impedance	10 k Ohms
Max. input level	+22 dBu

Equalizer

LOW	50 Hz / + - 15 dB
MID	700 Hz / + - 15 dB
HIGH	10 kHz / + - 15 dB

Channel inserts

Type	1/4" TRS jack, unbalanced
Max. input level	+22 dBu

MON/FX send

Type	1/4" mono jack, unbalanced
Impedance	120 Ohms
Max. output level	+22 dBu

10**Main outputs**

Type	¼" TRS jack, electronically balanced
Impedance	240 Ohms balanced, 120 Ohms balanced
Max. output level	+28 dBu

Phones output

Type	¼" TRS jack, unbalanced
Max. output level	+19 dBu / 150 Ohms (+25 dBm)

CD/Tape out

Type	RCA connector
Impedance	1 k Ohms
Max. output level	+22 dBu

Main mix system data (Noise)³

Main mix @ -∞, channel fader @ -∞	-100 dB / -102.5 dB A weighted
Main mix @ 0 dB, channel fader @ -∞	-82 dB / -85 dB A weighted
Main mix @ 0 dB, channel fader @ 0 dB	-72 dB / -75 dB A weighted

Power supply

Power consumption	50 W
Fuse (100 - 120 V~, 50/60 Hz)	T 2,0 A H 250 V
Fuse (220 - 230 V~, 50/60 Hz)	T 2,0 A H 250 V
Mains connector	Standard IEC receptacle

Phantom power

With battery power	+18V
With AC adaptor	+23V

Battery

Battery life	4 hours w/ high quality Alkaline battery
--------------	------------------------------------------

Physical/weight

Dimensions (H x W x D)	1 9/16" (40 mm) / 2 7/8" (73 mm) x 11 3/4" (298 mm) x 8 1/2" (216 mm)
Weight	5.5 lbs / 2.5 kg (PSU not included)

Limited warranty

§ 1 Warranty

① This limited warranty is valid only if you purchased the product from a BEHRINGER authorized dealer in the country of purchase. A list of authorized dealers can be found on BEHRINGER's website www.behringer.com under "Where to Buy", or you can contact the BEHRINGER office closest to you.

② BEHRINGER* warrants the mechanical and electronic components of this product to be free of defects in material and workmanship if used under normal operating conditions for a period of one (1) year from the original date of purchase (see the Limited Warranty terms in § 4 below), unless a longer minimum warranty period is mandated by applicable local laws. If the product shows any defects within the specified warranty period and that defect is not excluded under § 4, BEHRINGER shall, at its discretion, either replace or repair the product using suitable new or reconditioned product or parts. In case BEHRINGER decides to replace the entire product, this limited warranty shall apply to the replacement product for the remaining initial warranty period, i.e., one (1) year (or otherwise applicable minimum warranty period) from the date of purchase of the original product.

③ Upon validation of the warranty claim, the repaired or replacement product will be returned to the user freight prepaid by BEHRINGER.

④ Warranty claims other than those indicated above are expressly excluded.

PLEASE RETAIN YOUR SALES RECEIPT. IT IS YOUR PROOF OF PURCHASE COVERING YOUR LIMITED WARRANTY. THIS LIMITED WARRANTY IS VOID WITHOUT SUCH PROOF OF PURCHASE.

§ 2 Online registration

Please do remember to register your new BEHRINGER equipment right after your purchase at www.behringer.com under "Support" and kindly read the terms and conditions of our limited warranty carefully. Registering your purchase and equipment with us helps us process your repair claims quicker and more efficiently. Thank you for your cooperation!

§ 3 Return authorization number

① To obtain warranty service, please contact the retailer from whom the equipment was purchased. Should your BEHRINGER dealer not be located in your vicinity, you may contact the BEHRINGER distributor for your country listed under "Support" at www.behringer.com. If your country is not listed, please check if your problem can be dealt with by our "Online Support" which may also be found under "Support" at www.behringer.com. Alternatively, please submit an online warranty claim at www.behringer.com BEFORE returning the product. All inquiries must be accompanied by a description of the problem and the serial number of the product. After verifying the product's warranty eligibility with the original sales receipt, BEHRINGER will then issue a Return Materials Authorization ("RMA") number.

② Subsequently, the product must be returned in its original shipping carton, together with the return authorization number to the address indicated by BEHRINGER.

③ Shipments without freight prepaid will not be accepted.

§ 4 Warranty Exclusions

① This limited warranty does not cover consumable parts including, but not limited to, fuses and batteries. Where applicable, BEHRINGER warrants the valves or meters contained in the product to be free from defects in material and workmanship for a period of ninety (90) days from date of purchase.

② This limited warranty does not cover the product if it has been electronically or mechanically modified in any way. If the product needs to be modified or adapted in order to comply with applicable technical or safety standards on a national or local level, in any country which is not the country for which the product was originally developed and manufactured, this modification/adaptation shall not be considered a defect in materials or workmanship. This limited warranty does not cover any such modification/adaptation, regardless of whether it was carried out properly or not. Under the terms of this limited warranty, BEHRINGER shall not be held responsible for any cost resulting from such a modification/adaptation.

③ This limited warranty covers only the product hardware. It does not cover technical assistance for hardware or software usage and it does not cover any software products whether or not contained in the product. Any such software is provided "AS IS" unless expressly provided for in any enclosed software limited warranty.

④ This limited warranty is invalid if the factory-applied serial number has been altered or removed from the product.

⑤ Free inspections and maintenance/repair work are expressly excluded from this limited warranty, in particular, if caused by improper handling of the product by the user. This also applies to defects caused by normal wear and tear, in particular, of faders, crossfaders, potentiometers, keys/buttons, tubes, guitar strings, illuminants and similar parts.

⑥ Damage/defects caused by the following conditions are not covered by this limited warranty:

- improper handling, neglect or failure to operate the unit in compliance with the instructions given in BEHRINGER user or service manuals;
- connection or operation of the unit in any way that does not comply with the technical or safety regulations applicable in the country where the product is used;
- damage/defects caused by acts of God/Nature (accident, fire, flood, etc) or any other condition that is beyond the control of BEHRINGER.

⑦ Any repair or opening of the unit carried out by unauthorized personnel (user included) will void the limited warranty.

⑧ If an inspection of the product by BEHRINGER shows that the defect in question is not covered by the limited warranty, the inspection costs are payable by the customer.

⑨ Products which do not meet the terms of this limited warranty will be repaired exclusively at the buyer's expense. BEHRINGER or its authorized service center will inform the buyer of any such circumstance. If the buyer fails to submit a written repair order within 6 weeks after notification, BEHRINGER will return the unit C.O.D. with a separate invoice for freight and packing. Such costs will also be invoiced separately when the buyer has sent in a written repair order.

⑩ Authorized BEHRINGER dealers do not sell new products directly in online auctions. Purchases made through an online auction are on a "buyer beware" basis. Online auction confirmations or sales receipts are not accepted for warranty verification and BEHRINGER will not repair or replace any product purchased through an online auction.

§ 5 Warranty transferability

This limited warranty is extended exclusively to the original buyer (customer of authorized retail dealer) and is not transferable to anyone who may subsequently purchase this product. No other person (retail dealer, etc.) shall be entitled to give any warranty promise on behalf of BEHRINGER.

Legal Disclaimer

§ 6 Claim for damage

Subject only to the operation of mandatory applicable local laws, BEHRINGER shall have no liability to the buyer under this warranty for any consequential or indirect loss or damage of any kind. In no event shall the liability of BEHRINGER under this limited warranty exceed the invoiced value of the product.

§ 7 Limitation of liability

This limited warranty is the complete and exclusive warranty between you and BEHRINGER. It supersedes all other written or oral communications related to this product. BEHRINGER provides no other warranties for this product.

§ 8 Other warranty rights and national law

- ① This limited warranty does not exclude or limit the buyer's statutory rights as a consumer in any way.
- ② The limited warranty regulations mentioned herein are applicable unless they constitute an infringement of applicable mandatory local laws.
- ③ This warranty does not detract from the seller's obligations in regard to any lack of conformity of the product and any hidden defect.

§ 9 Amendment

Warranty service conditions are subject to change without notice. For the latest warranty terms and conditions and additional information regarding BEHRINGER's limited warranty, please see complete details online at www.behringer.com.

* BEHRINGER Macao Commercial Offshore Limited of Rue de Pequim No. 202-A, Macau Finance Centre 9/J, Macau, including all BEHRINGER group companies

Technical specifications and appearance are subject to change without notice. The information contained herein is correct at the time of printing. BEHRINGER accepts no liability for any loss which may be suffered by any person who relies either wholly or in part upon any description, photograph or statement contained herein. Colors and specifications may vary slightly from product. BEHRINGER products are sold through authorized dealers only. Distributors and dealers are not agents of BEHRINGER and have absolutely no authority to bind BEHRINGER by any express or implied undertaking or representation. This manual is copyrighted. No part of this manual may be reproduced or transmitted in any form or by any means, electronic or mechanical, including photocopying and recording of any kind, for any purpose, without the express written permission of Red Chip Company Ltd.

ALL RIGHTS RESERVED. © 2009 Red Chip Company Ltd.
Trident Chambers, Wickhams Cay, P.O. Box 146,
Road Town, Tortola, British Virgin Islands

FEDERAL COMMUNICATIONS COMMISSION COMPLIANCE INFORMATION



Responsible party name: BEHRINGER USA, Inc.
Address: 18912 North Creek Parkway,
Suite 200 Bothell, WA 98011,
USA
Phone/Fax No.: Phone: +1 425 672 0816
Fax: +1 425 673 7647

hereby declares that the product

XENYX 1002B

complies with the FCC rules as mentioned in the following paragraph:

This equipment has been tested and found to comply with the limits for a Class B digital device, pursuant to part 15 of the FCC Rules. These limits are designed to provide reasonable protection against harmful interference in a residential installation. This equipment generates, uses and can radiate radio frequency energy and, if not installed and used in accordance with the instructions, may cause harmful interference to radio communications. However, there is no guarantee that interference will not occur in a particular installation. If this equipment does cause harmful interference to radio or television reception, which can be determined by turning the equipment off and on, the user is encouraged to try to correct the interference by one or more of the following measures:

- Reorient or relocate the receiving antenna.
- Increase the separation between the equipment and receiver.
- Connect the equipment into an outlet on a circuit different from that to which the receiver is connected.
- Consult the dealer or an experienced radio/TV technician for help.

This device complies with Part 15 of the FCC rules. Operation is subject to the following two conditions:

- (1) this device may not cause harmful interference, and
- (2) this device must accept any interference received, including interference that may cause undesired operation.

Important information:

Changes or modifications to the equipment not expressly approved by BEHRINGER USA can void the user's authority to use the equipment.



This manual is available in English, German, Spanish and Chinese. Download them by going to the appropriate product page at:

www.behringer.com