



***114LCM***

***INSTRUCTION MANUAL***

# TABLE OF CONTENTS

|  |           |
|--|-----------|
| <b>INTRODUCTION .....</b>                        | <b>4</b>  |
| Warning .....                                    | 4         |
| <b>ASSEMBLY .....</b>                            | <b>6</b>  |
| Assembling the Telescope .....                   | 6         |
| Attaching the Hand Control Holder .....          | 7         |
| Attaching the Motorized Base to the Tripod ..... | 7         |
| Attaching the Telescope to the Base .....        | 7         |
| The Eyepiece.....                                | 8         |
| Focusing.....                                    | 8         |
| The Star Pointer Finderscope .....               | 8         |
| Aligning the Star Pointer.....                   | 9         |
| Attaching the Hand Control .....                 | 9         |
| Powering the Telescope .....                     | 9         |
| <b>HAND CONTROL .....</b>                        | <b>11</b> |
| The Hand Control .....                           | 11        |
| Hand Control Operation.....                      | 12        |
| Alignment Procedure .....                        | 13        |
| Sky Align .....                                  | 13        |
| Auto Two-Star Align .....                        | 15        |
| Two Star Alignment.....                          | 15        |
| One-Star Align .....                             | 16        |
| Solar System Align .....                         | 16        |
| Re-Alignment.....                                | 17        |
| Object Catalog .....                             | 17        |
| Selecting an Object .....                        | 17        |
| Slewing to an Object.....                        | 18        |
| Finding Planets .....                            | 18        |
| Tour Mode .....                                  | 18        |
| Constellation Tour .....                         | 18        |
| Direction Buttons.....                           | 19        |
| Rate Button .....                                | 19        |
| Set Up Procedures.....                           | 19        |
| Tracking Mode.....                               | 19        |
| Tracking Rate.....                               | 19        |
| View Time-Site.....                              | 20        |
| User Defined Objects.....                        | 20        |
| Get R.A./DEC. ....                               | 20        |
| Goto R.A./DEC.....                               | 20        |
| Identify.....                                    | 21        |
| Scope Setup Features .....                       | 21        |
| Anti-backlash.....                               | 21        |
| Slew Limits .....                                | 21        |
| Filter Limits .....                              | 21        |
| Direction Buttons .....                          | 21        |
| Goto Approach.....                               | 22        |
| Cordwrap .....                                   | 22        |
| Utility Features .....                           | 22        |
| GPS On/Off.....                                  | 22        |
| Light Control.....                               | 22        |
| Factory Setting .....                            | 22        |
| Version.....                                     | 22        |
| Get Axis Position .....                          | 22        |
| Goto Axis Position.....                          | 22        |
| Hibernate.....                                   | 22        |
| Sun Menu .....                                   | 23        |
| Scrolling Menu .....                             | 23        |
| Calibrate Goto.....                              | 23        |

|  |           |
|--|-----------|
| Set Mount Position.....                            | 23        |
| <b>TELESCOPE BASICS .....</b>                      | <b>25</b> |
| Focusing.....                                      | 25        |
| Image Orientation .....                            | 25        |
| Calculating Magnification.....                     | 25        |
| Determining Field of View .....                    | 26        |
| General Observing Hints.....                       | 26        |
| <b>CELESTIAL OBSERVING.....</b>                    | <b>27</b> |
| Observing the Moon .....                           | 27        |
| Lunar Observing Hints.....                         | 27        |
| Observing the Planets.....                         | 27        |
| Planetary Observing Hints .....                    | 27        |
| Observing the Sun.....                             | 27        |
| Solar Observing Hints.....                         | 28        |
| Observing Deep Sky Objects .....                   | 28        |
| Seeing Conditions .....                            | 28        |
| Transparency.....                                  | 28        |
| Sky Illumination.....                              | 28        |
| Seeing .....                                       | 29        |
| <b>TELESCOPE MAINTENANCE .....</b>                 | <b>30</b> |
| Care and Cleaning of the Optics .....              | 30        |
| Collimation .....                                  | 30        |
| <b>OPTIONAL ACCESSORIES.....</b>                   | <b>32</b> |
| <b>APPENDIX A - TECHNICAL SPECIFICATIONS .....</b> | <b>34</b> |
| <b>APPENDIX B – GLOSSARY OF TERMS.....</b>         | <b>35</b> |
| <b>APPENDIX D – TIME ZONE MAPS.....</b>            | <b>38</b> |
| <b>SKY MAPS.....</b>                               | <b>40</b> |

# **CELESTRON** **Introduction**

Congratulations on your purchase of the Celestron LCM telescope! The LCM ushers in a whole new generation of computer automated technology. Simple and friendly to use, the LCM telescope is up and running after locating just three bright celestial objects. It's the perfect combination of power and portability. If you are new to astronomy, you may wish to start off by using the LCM's built-in Sky Tour feature, which commands the LCM to find the most interesting objects in the sky and automatically slews to each one. Or if you are more experienced, you will appreciate the comprehensive database of over 4,000 objects, including customized lists of all the best deep-sky objects, planets, bright double stars. No matter at what level you are starting out, the LCM will unfold for you and your friends all the wonders of the Universe.

Some of the many standard features of the LCM telescope include:

- Incredible 3°/second slew speed.
- Fully enclosed motors and optical encoders for position location.
- Computerized hand controller with 4,000 object database.
- Storage for programmable user defined objects; and
- Many other high performance features!

The LCM's deluxe features combined with Celestron's legendary optical standards give amateur astronomers one of the most sophisticated and easy to use telescopes available on the market today.

Take time to read through this manual before embarking on your journey through the Universe. It may take a few observing sessions to become familiar with your telescope, so you should keep this manual handy until you have fully mastered your telescope's operation. The LCM hand control has built-in instructions to guide you through all the alignment procedures needed to have the telescope up and running in minutes. Use this manual in conjunction with the on-screen instructions provided by the hand control. The manual gives detailed information regarding each step as well as needed reference material and helpful hints guaranteed to make your observing experience as simple and pleasurable as possible.

Your LCM telescope is designed to give you years of fun and rewarding observations. However, there are a few things to consider before using your telescope that will ensure your safety and protect your equipment.

## **Warning**



- ❑ **Never look directly at the sun with the naked eye or with a telescope (unless you have the proper solar filter). Permanent and irreversible eye damage may result.**
- ❑ Never use your telescope to project an image of the sun onto any surface. Internal heat build-up can damage the telescope and any accessories attached to it.
- ❑ Never use an eyepiece solar filter or a Herschel wedge. Internal heat build-up inside the telescope can cause these devices to crack or break, allowing unfiltered sunlight to pass through to the eye.
- ❑ Never leave the telescope unsupervised, either when children are present or adults who may not be familiar with the correct operating procedures of your telescope.



|   |                                 |    |                                |
|---|---------------------------------|----|--------------------------------|
| 1 | <b>Eyepiece</b>                 | 7  | <b>Hand Control</b>            |
| 2 | <b>Focuser Knob</b>             | 8  | <b>Motorized Base</b>          |
| 3 | <b>Star Pointer Finderscope</b> | 9  | <b>Altitude Clutch Knob</b>    |
| 4 | <b>On/Off Switch</b>            | 10 | <b>Telescope Tube</b>          |
| 5 | <b>Tripod</b>                   | 11 | <b>Telescope Mounting Bolt</b> |
| 6 | <b>Accessory Tray</b>           |    |                                |



The LCM comes partially assembled and can be operational in a matter of minutes. The LCM is conveniently packaged in one reusable shipping carton that contains the following accessories:

- 5-piece eyepiece kit with case
- Star Pointer Finderscope
- Accessory Tray
- *The Sky*™ X Student Edition Astronomy Software
- NexStar Hand Control w/ 4,000 Object Database

## ***Assembling the Telescope***

Your LCM comes in three major sections: the optical tube, the motorized mount and the tripod. These sections can be attached in seconds using the quick release coupling screw located under the tripod mounting platform and the dovetail mounting clamp located on the inside of the fork arm. To begin, remove all of the accessories from their individual boxes. Remember to save all of the containers so that they can be used to transport the telescope. Before attaching the visual accessories, the telescope tube and mount should be attached to the tripod. First, install the accessory tray onto the tripod legs:

1. Remove the tripod from the box and spread the legs apart until the center leg brace is fully extended.
2. Locate the accessory tray, and place it on top of the tripod center support brace in between the tripod legs (see figure 2-1).
3. Rotate the accessory tray so that the central hole in the tray slides over the flange post in the center of the support bracket.
4. Finally, rotate the tray so that the locking tabs slide under the locking clips on support bracket. You will feel the tray snap into place.

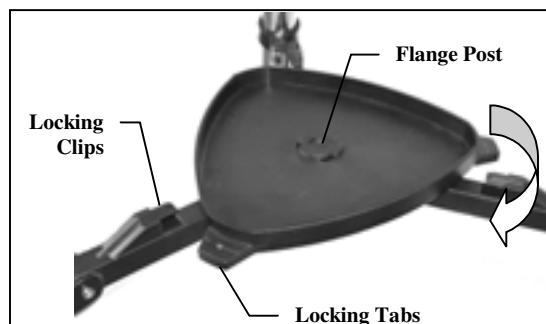

**Figure 2-1**

It is a good idea to level the tripod by adjusting the height of the tripod legs before attaching the fork arm and tube. Minor adjustments can be made later. To adjust the height of the tripod legs:

1. Lift the tripod leg locking lever located on the side of each leg.
2. Slide the inner portion of each leg down 6" to 8" inches.
3. Adjust the tripod height until the base is visually level and press down the locking levers to secure into place.

## Attaching the Hand Control Holder

The LCM comes with a snap-on hand control holder that conveniently attaches to any of the tripod legs. To attach the hand control holder simply position the holder with the square plastic tab facing up and push against the tripod leg until it snaps in to place.

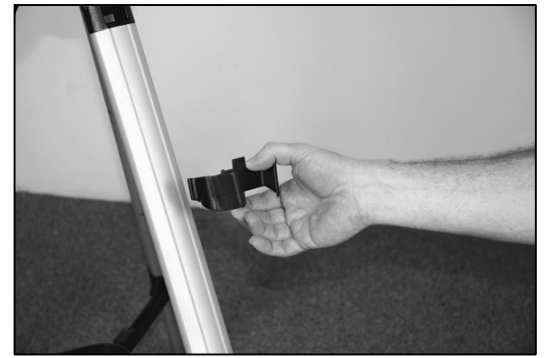

Figure 2-3

## Attaching the Motorized Base to the Tripod

With the tripod properly assembled, the motorized base can easily be attached using the quick release coupling screw located underneath the tripod mounting platform:

1. Place the motorized base on top of the tripod making sure that the three round feet rest on the round flat pads on the inside of the tripod head.
2. Thread the coupling screw into the hole at the bottom of the fork arm base and hand tighten.

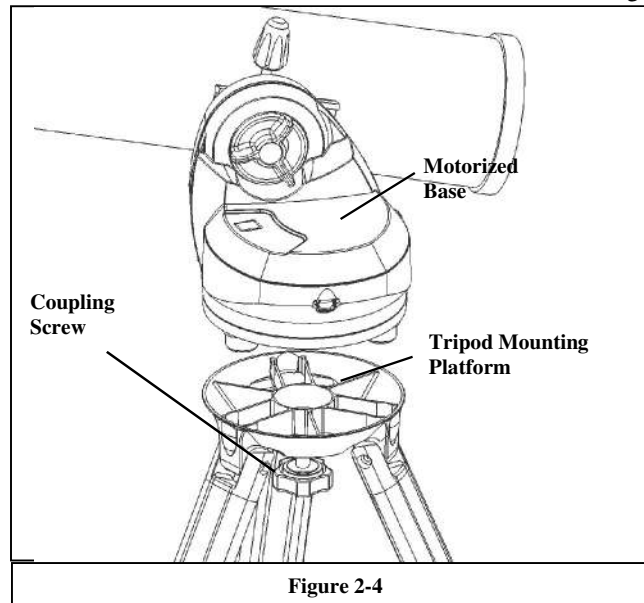

Figure 2-4

## Leveling the Telescope

Now that the base is attached to the tripod, it is a good idea to use the included bubble level to more accurately level the telescope.

1. Place the bubble level on the top of the motorized base.
2. Adjust the tripod legs until the bubble level shows the base to be level.

## Attaching the Telescope to the Base

Your telescope optical tube has a built on dovetail mounting bar used to attach the tube to the base. To attach the telescope tube:

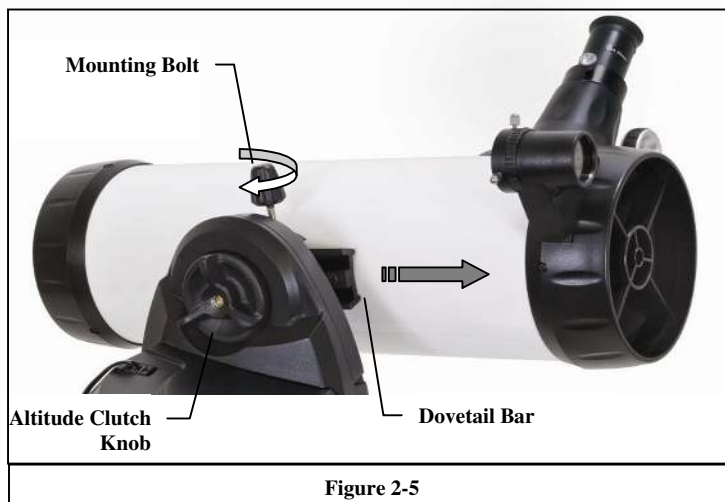

Figure 2-5

1. Loosen the altitude clutch and rotate the tube clamp so that the mounting bolt is positioned on the top of the base. Retighten the altitude knob by hand, but do not over tighten.
2. Loosen the tube clamp mounting bolt.
3. Slide the dovetail mounting bar of the telescope tube into the tube clamp. Make sure that the focuser is pointing up when the tube is attached to the base.
4. Tighten the mounting bolt by hand to secure the tube to the base.

Your telescope is fully assembled and is ready to attach the accessories.

## The Eyepiece

The eyepiece, is the optical element that magnifies the image focused by the telescope. To install the eyepiece:

1. Loosen the thumb screw on the eyepiece adapter at the end of the focuser barrel and remove the protective dust cap from the focuser barrel.
2. Slide the chrome portion of the low power 25mm eyepiece into the eyepiece adapter.
3. Tighten the thumbscrew to hold the eyepiece in place.

To remove the eyepiece, loosen the thumbscrew on the eyepiece barrel and slide the eyepiece out.

Eyepieces are commonly referred to by focal length and barrel diameter. The focal length of each eyepiece is printed on the eyepiece barrel. The longer the focal length (i.e., the larger the number) the lower the eyepiece power or magnification; and the shorter the focal length (i.e., the smaller the number) the higher the magnification. Generally, you will use low-to-moderate power when viewing. For more information on how to determine power, see the section on “Calculating Magnification.”

Barrel diameter is the diameter of the barrel that slides into the star diagonal or focuser. The LCM uses eyepieces with a standard 1-1/4" barrel diameter.

## Focusing

To focus your telescope, simply turn either of the focus knobs at the eyepiece end of the optical tube (see figures 2-6). Turn the focus knob until the image is sharp. Once sharp, turn the knob towards you to focus on an object that is closer than the one you are currently observing. Turn the knob away from you to focus on a more distant object than the one you are currently observing.

## The Star Pointer Finderscope

The Star Pointer is the quickest and easiest way to point your telescope exactly at a desired object in the sky. It's like having a laser pointer that you can shine directly onto the night sky. The Star Pointer is a zero magnification pointing tool that uses a coated glass window to superimpose the image of a small red dot onto the night sky. While keeping both eyes open when looking through the Star Pointer, simply move your telescope until the red dot, seen through the Star Pointer, merges with the object as seen with your unaided eye. The red dot is produced by a light-emitting diode (LED); it is not a laser beam and will not damage the glass window or your eye. The star pointer is powered by a long life 3-volt lithium battery (#CR1620). Like all finderscopes, the Star Pointer must be properly aligned with the main telescope before it can be used. The alignment procedure is best done at night since the LED dot will be difficult to see during the day.

### Install the Battery

1. Unscrew the battery cover on the StarPointer finderscope.
2. Insert battery with “+”side facing out.
3. Replace battery cover.

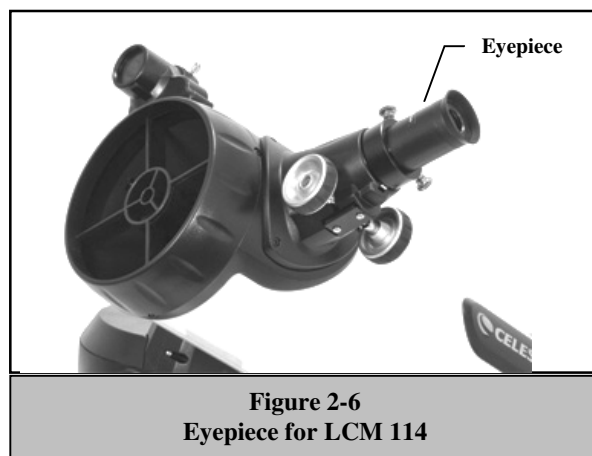

Figure 2-6  
Eyepiece for LCM 114

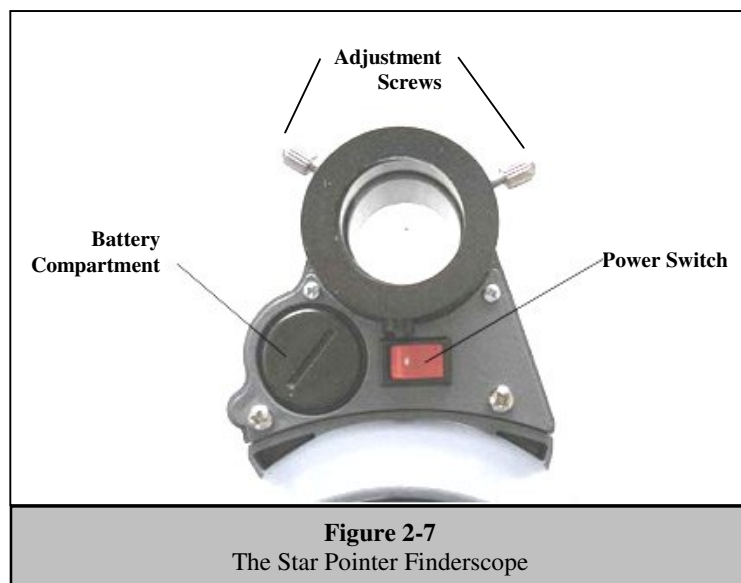

Figure 2-7  
The Star Pointer Finderscope

## Aligning the Star Pointer

1. To turn on the Star Pointer, turn the switch to the “on” position – see Figure 2-7
2. Locate a bright star or planet and center it in a low power eyepiece in the main telescope.
3. With both eyes open, look through the glass window at the alignment star. If the Star Pointer is perfectly aligned, you will see the red LED dot overlap the alignment star. If the Star Pointer is not aligned, take notice of where the red dot is relative to the bright star.
4. Without moving the main telescope, turn the Star Pointer's two adjustment screws until the red dot is directly over the alignment star. Experiment as to which way each screw moves the red dot.

The Star Pointer is now ready for use. **Always turn the power off after you have found an object. This will extend the life of both the battery and the LED.**

## Attaching the Hand Control

The LCM hand control has a phone jack type connector at the end of its cord. Plug the phone jack connector into the outlet at the base of the telescope's fork arm. Push the connector into the outlet until it clicks into place and place the hand control into its holder as described previously in the Assembly section of the manual.

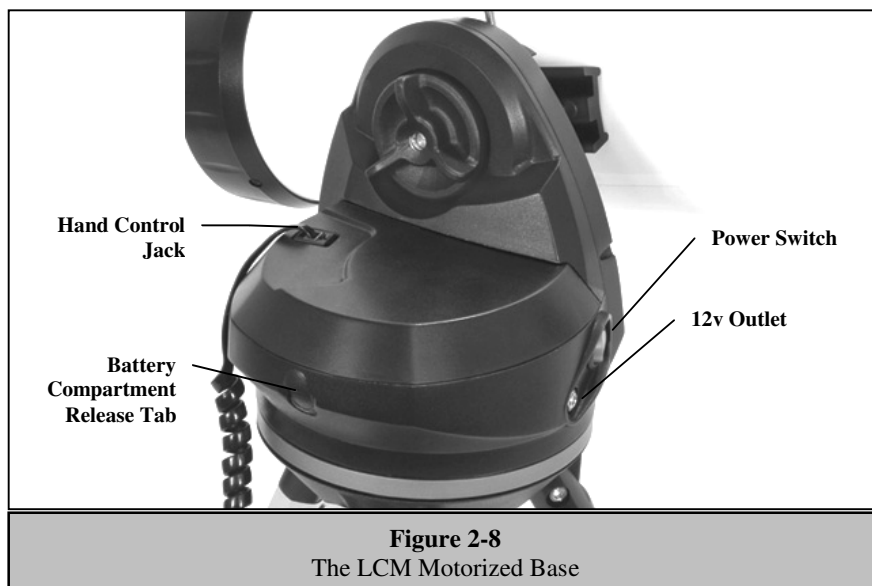

## Powering the Telescope

The LCM can be powered by 8 user supplied AA size alkaline batteries or an optional 12V AC adapter. To install batteries into the LCM:

1. Press the tab on the front of the battery compartment and remove the cover.
2. Gently remove the battery holder from inside the battery compartment.
3. Place 8-AA batteries (user supplied) inside the battery holder.
4. Return the battery holder back inside the base and replace the cover.
5. Flip the power switch to the “On” position. The light on the power button should come on.

*In case of a loss of power, the optical tube can be moved by hand. However, when powered on, the telescope should always be controlled via the hand control. The telescope will lose its star alignment if moved by hand when powered on.*



**Figure 2-9 – Removing the Battery Compartment Lid**

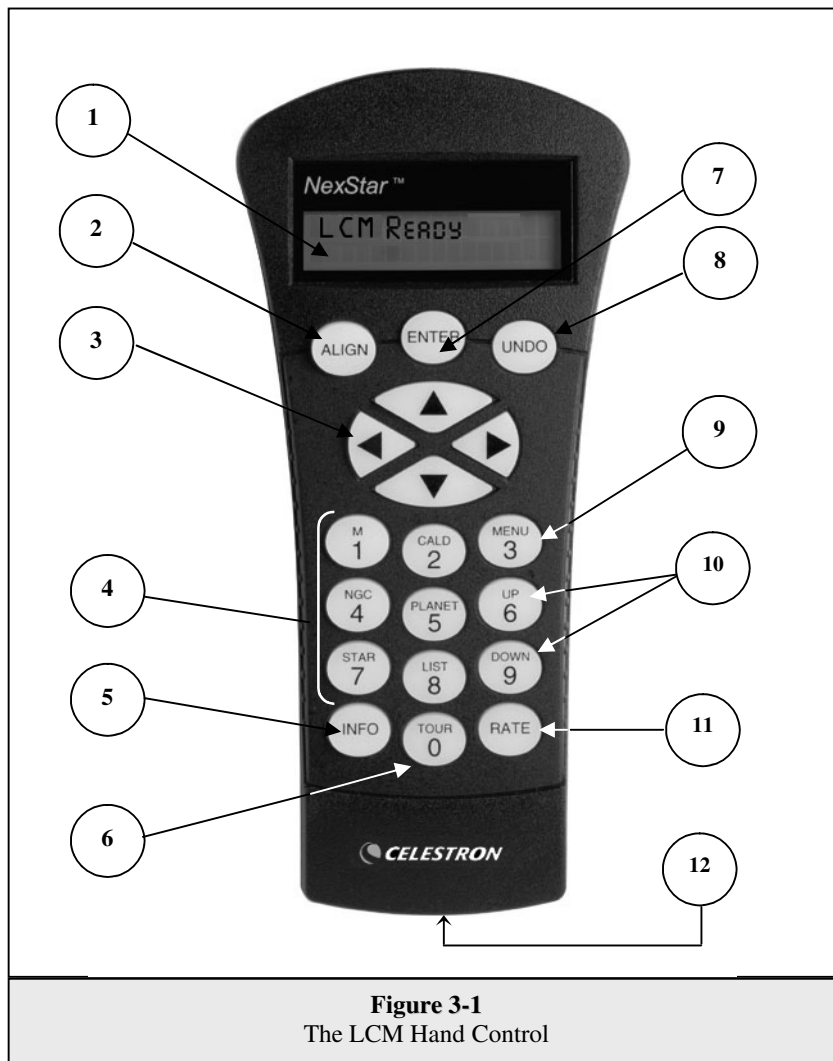

**Figure 2-9-1 – Inserting the batteries**



### The Hand Control

The LCM's hand controller is designed to give you instant access to all the functions the telescope has to offer. With automatic slewing to over 4,000 objects, and common sense menu descriptions, even a beginner can master its variety of features in just a few observing sessions. Below is a brief description of the individual components of the LCM hand controller:



**Figure 3-1**  
The LCM Hand Control

- Liquid Crystal Display (LCD) Window:** Has a dual-line, 16 character display screen that is backlit for comfortable viewing of telescope information and scrolling text.
- Align:** Instructs the LCM to use a selected star or object as an alignment position.
- Direction Keys:** Allows complete control of the telescope in any direction. Use the direction keys to center objects in the StarPointer finderscope and eyepiece.
- Catalog Keys:** The hand control has a key on the hand control to allow direct access to each of the catalogs in its 4,000+ object database. The hand control contains the following catalogs in its database:
  - Messier* – Complete list of all Messier objects.
  - NGC* – Many of the brightest deep sky objects from the Revised New General Catalog.
  - Caldwell* – A combination of the best NGC and IC objects.
  - Planets* - All 8 planets in our Solar System plus the Moon and Sun.
  - Stars* – A compiled list of the brightest stars from the SAO catalog.

*List* – For quick access, all of the best and most popular objects in the database have been broken down into lists based on their type and/or common name:

|                       |   |
|-----------------------|---|
| <b>Named Stars</b>    | Common name listing of the brightest stars in the sky.  |
| <b>Named Objects</b>  | Alphabetical listing of over 50 of the most popular deep sky objects.                             |
| <b>Double Stars</b>   | Alphabetical listing of the most visually stunning double, triple and quadruple stars in the sky. |
| <b>Variable Stars</b> | Select list of the brightest variable stars with the shortest period of changing magnitude.       |
| <b>Asterisms</b>      | A unique list of some of the most recognizable star patterns in the sky.                          |

5. **Info:** Displays coordinates and useful information about objects selected from the database.
6. **Tour:** Activates the tour mode, which seeks out all the best objects for a given month and automatically slews the telescope to those objects.
7. **Enter:** Pressing *Enter* allows you to select any of the LCM functions, accept entered parameters and slew the telescope to displayed objects.
8. **Undo:** *Undo* will take you out of the current menu and display the previous level of the menu path. Press *Undo* repeatedly to get back to a main menu or use it to erase data entered by mistake.
9. **Menu:** Displays the many setup and utilities functions such as tracking rate and user defined objects and many others.
10. **Scroll Keys:** Used to scroll up and down within any of the menu lists. A double arrow symbol on the right side of the LCD indicates that the scroll keys can be used to view additional information.
11. **Rate:** Instantly changes the rate of speed of the motors when the direction buttons are pressed.
12. **RS-232 Jack:** Allows use with a computer and software programs for point and click slewing capability.

## ***Hand Control Operation***

This section describes the basic hand control procedures needed to operate the LCM . These procedures are grouped into three categories: Alignment, Setup and Utilities. The alignment section deals with the initial telescope alignment as well as finding objects in the sky; the setup section discusses changing parameters such as tracking mode and tracking rate; finally, the last section reviews all of the utility functions such as adjusting the telescopes slew limits and backlash compensation.

## Alignment Procedure

In order for the LCM to accurately point to objects in the sky, it must first be aligned to known positions (stars) in the sky. With this information, the telescope can create a model of the sky, which it uses to locate any object with known coordinates. There are many ways to align the LCM with the sky depending on what information the user is able to provide: **SkyAlign** uses your current date, time and city to create an accurate model of the sky. Then the user can simply point the telescope to any three bright celestial objects to accurately align the telescope with the sky. **Auto Two-Star Align** will ask the user to choose and center the first alignment star, then the LCM will automatically select and slew to a second star for alignment. **Two-Star Alignment** requires the user to identify and manually slew the telescope to the two alignment stars. **One-Star Align** is the same as Two-Star Align however only requires you to align to one known star. Although not as accurate as the other alignment methods, One-Star Align is the quickest way to find and track bright planets and objects in Altazimuth mode. Finally, **Solar System Align** will display a list of visible daytime objects (planets and the moon) available to align the telescope. Each alignment method is discussed in detail below.

### Definition

"Altazimuth" or "Alt-Az" refers to a type of mounting that allows a telescope to move in both altitude (up and down) and azimuth (left and right) with respect to the ground. This is the simplest form of mounting in which the telescope is attached directly to a tripod.

## Sky Align

Sky Align is the easiest way to get your telescope aligned and ready to observe. Even if you do not know a single star in the sky, the LCM will have you aligned in minutes by asking for basic information like the date, time and location. Then you simply need to aim the telescope to any three bright celestial objects in the sky. Since Sky Align requires no knowledge of the night sky it is not necessary to know the name of the stars at which you are aiming. You may even select a planet or the moon. The LCM is then ready to start finding and tracking any of the objects in its 4,000+ object database. Before the telescope is ready to be aligned, it should be set up in an outside location with all accessories (eyepiece, diagonal and finderscope) attached and lens cover removed as described in the Assembly section of the manual. To begin Sky Align:

1. Power on the LCM by flipping the switch located on the side of the fork arm, to the "on" position. Once turned on the hand control display will say **LCM Ready**. Press ENTER to choose *Sky Align*. Pressing the ALIGN key will bypass the other alignment options and the scrolling text and automatically begins *Sky Align*.
2. Once *Sky Align* has been selected, the hand control will display "Enter if OK", "Undo to edit" and "Saved Site". The bottom line of the LCD will display either the current time or the time when you last used the telescope. Since this is your first time using the LCM, press UNDO to enter current time/site information.

The hand control display will then ask for the following information:

**Location** - The hand control will display a list of cities to choose from. Choose the city from the database that is closest to your current observing site. The city you choose will be remembered in the hand controls memory so that it will be automatically displayed the next time an alignment is done. Alternatively, if you know the exact longitude and latitude of your observing site, it can be entered directly into the hand control and remembered for future use as well. To choose a location city:

- ❑ Use the Up and Down scroll keys to choose between *City Database* and *Custom Site*. *City Database* will allow you to select the closest city to your observing site from a list of either international or U.S. location. *Custom Site* allows you to enter the exact longitude and latitude of your observing site. Select *City Database* and press ENTER.
- ❑ The hand control will allow you to choose from either U.S. or international locations. For a listing of U.S. locations by state and then by city, press ENTER while **United States** is displayed. For international locations, use the Up or Down scroll key to select **International** and press ENTER.
- ❑ Use the Up and Down Scroll buttons to choose your current state (or country if International locations was selected) from the alphabetical listing and press ENTER.
- ❑ Use the Up and Down Scroll buttons to choose the closest city to your location from the displayed list and press ENTER.



**Time** - Enter the current time for your area. You can enter either the local time (i.e. 8: 00), or you can enter military time (i.e. 20: 00).

- ❑ Select PM or AM. If military time was entered, the hand control will bypass this step.
- ❑ Choose between Standard time or Daylight Savings time. Use the Up and Down scroll buttons (10) to toggle between options.
- ❑ Select the time zone that you are observing from. Again, use the Up and Down buttons (10) to scroll through the choices. For time zone information, refer to the Time Zone map in the appendix of this manual.

**Date** - Enter the month, day and year of your observing session. The display will read: mm/ dd/ yy.

- *If the wrong information has been input into the hand control, the UNDO button will act as a backspace allowing the user to re-enter information.*
  - *The next time that your telescope is aligned, the hand control will automatically display the last location (either a city or longitude/latitude) that was entered. Press ENTER to accept these parameters if they still apply. Pressing the UNDO button will allow you to go back and select a new city location or longitude/latitude.*
3. Use the arrow buttons on the hand control to slew (move) the telescope towards any bright celestial object in the sky. Align the object with the red dot of the finderscope and press ENTER.
  4. If the finderscope has been properly aligned with the telescope tube, the alignment star should now be visible inside the field of view of the eyepiece. The hand control will ask that you center the bright alignment star in the center of the eyepiece and press the ALIGN button. This will accept the star as the first alignment position. (There is no need to adjust the slewing rate of the motors after each alignment step. The LCM automatically selects the best slewing rate for aligning objects in both the finderscope and the eyepiece).
  5. For the second alignment object, choose a bright star or planet as far as possible from the first alignment object. Once again use the arrow button to center the object in the finderscope and press ENTER. Then once centered in the eyepiece press the ALIGN button.
  6. Repeat the process for the third alignment star. When the telescope has been aligned to the final stars, the display will read "**Mat ch Conf i r m ed**". Press UNDO to display the names of the three bright objects you aligned to, or press ENTER to accept these three objects for alignment. You are now ready to find your first object.

### Tips for Using Sky Align

Remember the following alignment guidelines to make using Sky Align as simple and accurate as possible.

- Be sure to level the tripod before you begin alignment. The time/site information along with a level tripod will help the telescope better predict the available bright stars and planets that are above the horizon.
- Remember to select alignment stars that are as far apart in the sky as possible. For best results make sure that the third alignment star does not lie in a straight line between the first two stars. This may result in a failed alignment.
- Don't worry about confusing planets for stars when selecting alignment objects. SkyAlign works with the four brightest planets (Venus, Jupiter, Saturn and Mars) as well as the Moon. In addition to the planets, the hand control has over 80 bright alignment stars to choose from (down to 2.5 magnitude).
- Rarely SkyAlign will not be able to determine what three alignment objects were centered. This sometime happens when a bright planet or the Moon passes near one of the brighter stars. In situations like these it is best to try to avoid aligning to either object if possible.
- Be sure to center the objects with the same final movements as the direction of the GoTo Approach. For example, if the scope normally finishes a GoTo with the front of the scope moving right and up, you should center all three alignment objects in the eyepiece using the right and up arrow buttons (the up/down arrows reverse at slew rates of 6 or lower). Approaching the star from this direction when looking through the eyepiece will eliminate much of the backlash between the gears and assure the most accurate alignment possible.

## Auto Two-Star Align

As with Sky Align, Auto Two-Star Align requires you to enter all the necessary time/site information as before. Once this information is entered, the hand control will prompt you to select and point the telescope at one known star in the sky. The LCM now has all the information it needs to automatically choose a second star that will assure the best possible alignment. Once selected the telescope will automatically slew to that second alignment star to complete the alignment. With the LCM set up outside with all accessories attached and the tripod leveled, follow the steps below to align the telescope:

1. Once the LCM is powered on, Press ENTER to begin alignment.
2. Use the Up and Down scroll keys (10) to select *Auto Two-Star Align* and press ENTER.
3. The hand control will display the last time and location information that was entered into the hand control. Use the Up and Down buttons to scroll through the information. Press ENTER to accept the current information or press UNDO to manually edit the information (see Sky Align section for detailed instruction on entering time/site information).
4. The display will now prompt you to select a bright star from the displayed list on the hand control. Use Up and Down buttons (6 and 9 on the keypad) to scroll to the desired star and then press ENTER.
5. Use the arrow buttons to slew the telescope to the star you selected. Center the star in the finderscope and press ENTER. Finally, center the star in the eyepiece and press ALIGN.
6. Based on this information, the LCM will automatically display the most suitable second alignment star that is above the horizon. Press ENTER to automatically slew the telescope to the displayed star. If for some reason you do not wish to select this star (perhaps it is behind a tree or building), you can either:
  - Press the UNDO button to display the next most suitable star for alignment.
  - Use the UP and DOWN scroll buttons to manually select any star you wish from the entire list of available stars.

Once finished slewing, the display will ask you to use the arrow buttons to align the selected star with the red dot of the finderscope. Once centered in the finder, press ENTER. The display will then instruct you to center the star in the field of view of the eyepiece. When the star is centered, press ALIGN to accept this star as your second alignment star. When the telescope has been aligned to both stars the display will read **Align Success**, and you are now ready to find your first object.

## Two Star Alignment

With the two-star alignment method, the LCM requires the user to know the positions of two bright stars in order to accurately align the telescope with the sky and begin finding objects. Here is an overview of the two-star alignment procedure:

1. Once the LCM is powered on, use the Up and Down scroll keys (10) to select Two-Star Align, and press ENTER.
2. Press ENTER to accept the time/site information displayed on the display, or press UNDO to enter new information.
3. The SELECT STAR 1 message will appear in the top row of the display. Use the Up and Down scroll keys (10) to select the star you wish to use for the first alignment star. Press ENTER.
4. The LCM then asks you to center in the eyepiece the alignment star you selected. Use the direction arrow buttons to slew the telescope to the alignment star and carefully center the star in the finderscope. Press ENTER when centered.
5. Then, center the star in the eyepiece and press ALIGN.



**Helpful Hint**

*In order to accurately center the alignment star in the eyepiece, you may wish to decrease the slew rate of the motors for fine centering. This is done by pressing the RATE key (11) on the hand controller then selecting the number that corresponds to the speed you desire. (9 = fastest, 1 = slowest).*

6. The LCM will then ask you to select and center a second alignment star and press the ALIGN key. It is best to choose alignment stars that are a good distance away from one another. Stars that are at least 40° to 60° apart from each other will give you a more accurate alignment than stars that are close to each other.

Once the second star alignment is completed properly, the display will read **Align Successful**, and you should hear the tracking motors turn-on and begin to track.

## One-Star Align

One-Star Align requires you to input all the same information as you would for the Two-Star Align procedure. However, instead of slewing to two alignment stars for centering and alignment, the LCM uses only one star to model the sky based on the information given. This will allow you to roughly slew to the coordinates of bright objects like the moon and planets and gives the LCM the information needed to track objects in altazimuth in any part of the sky. One-Star Align is not meant to be used to accurately locate small or faint deep-sky objects or to track objects accurately for photography.

To use One-Star Align:

1. Select One-Star Align from the alignment options.
2. Press ENTER to accept the time/site information displayed on the display, or press UNDO to enter new information.
3. The SELECT STAR 1 message will appear in the top row of the display. Use the Up and Down scroll keys (10) to select the star you wish to use for the first alignment star. Press ENTER.
4. The LCM then asks you to center in the eyepiece the alignment star you selected. Use the direction arrow buttons to slew the telescope to the alignment star and carefully center the star in the finderscope. Press ENTER when centered.
5. Then, center the star in the eyepiece and press ALIGN.
6. Once in position, the LCM will model the sky based on this information and display **Align Successful**.

Note: Once a One-Star Alignment has been done, you can use the Re-alignment feature (later in this section) to improve your telescope's pointing accuracy.

## Solar System Align

Solar System Align is designed to provide excellent tracking and GoTo performance by using solar system objects (Sun, Moon and planets) to align the telescope with the sky. Solar System Align is a great way to align your telescope for daytime viewing as well as a quick way to align the telescope for night time observing.



**Never look directly at the sun with the naked eye or with a telescope (unless you have the proper solar filter). Permanent and irreversible eye damage may result.**

1. Select *Solar System Align* from the alignment options.
2. Press ENTER to accept the time/site information displayed on the display, or press UNDO to enter new information.
3. The SELECT OBJECT message will appear in the top row of the display. Use the Up and Down scroll keys (10) to select the daytime object (planet, moon or sun) you wish to align. Press ENTER.
4. The LCM then asks you to center in the eyepiece the alignment object you selected. Use the direction arrow buttons to slew the telescope to the alignment object and carefully center it in the finderscope. Press ENTER when centered.
5. Then, center the object in the eyepiece and press ALIGN.

Once in position, the LCM will model the sky based on this information and display **Align Successful**.

### Tips for Using Solar System Align

- For safety purposes, the Sun will not be displayed in any of the hand control's customer object lists unless it is enabled from the Utilities Menu. To allow the Sun to be displayed on the hand control, do the following:
  1. Press the UNDO button until the display reads "LCM Ready"
  2. Press the MENU button and use the Up and Down keys to select the *Utilities menu*. Press ENTER.
  3. Use the UP and Down keys to select *Sun Menu* and press ENTER.
  4. Press ENTER again to allow the Sun to appear on the hand control display.

The Sun can be removed from the display by using the same procedure as above.

To improve the telescope pointing accuracy, you can use the Re-Align feature as described below.

## Re-Alignment

The LCM has a re-alignment feature which allows you to replace either of the original alignment stars with a new star or celestial object. This can be useful in several situations:

- If you are observing over a period of a few hours, you may notice that your original two alignment stars have drifted towards the west considerably. (Remember that the stars are moving at a rate of 15° every hour). Aligning on a new star that is in the eastern part of the sky will improve your pointing accuracy, especially on objects in that part of the sky.
- If you have aligned your telescope using the One-star align method, you can use *re-align* to align to an additional object in the sky. This will improve the pointing accuracy of your telescope without having to re-enter addition information.

To replace an existing alignment star with a new alignment star:

1. Select the desired star (or object) from the database and slew to it.
2. Carefully center the object in the eyepiece.
3. Once centered, press the UNDO button until you are at the main menu.
4. With LCM Ready displayed, press the ALIGN key on the hand control.
5. The display will then ask you which alignment star you want to replace.
6. Use the UP and Down scroll keys to select the alignment star to be replaced, and press ENTER. It is usually best to replace the star closest to the new object. This will space out your alignment stars across the sky. If you have used one of the single object alignment methods then it is always best to replace the object that is “unassigned” with an actual object.
7. Press ALIGN to make the change.

## Object Catalog

### Selecting an Object

Now that the telescope is properly aligned, you can choose an object from any of the catalogs in the LCM’s database. The hand control has a key designated for each of the catalogs in its database. There are two ways to select objects from the database; scrolling through the named object lists and entering object numbers:

- Pressing the LIST key on the hand control will access all objects in the database that have common names or types. Each list is broken down into the following categories: Named Stars, Named Object, Double Stars, Variable Stars and Asterisms. Selecting any one of these options will display an alpha-numeric listing of the objects under that list. Pressing the Up and Down keys (10) allows you to scroll through the catalog to the desired object.
- Pressing any of the catalog keys (M, CALD, NGC, or STAR) will display a blinking cursor below the name of the catalog chosen. Use the numeric key pad to enter the number of any object within these standardized catalogs. For example, to find the Orion Nebula, press the "M" key and enter "042".
- Pressing the PLANET button will allow you to use the UP and DOWN arrow keys to scroll through and select the eight planets as well as the moon.

When scrolling through a long list of objects, holding down either the Up or Down key will allow you to scroll through the catalog at a rapid speed.

When entering the number for a SAO star, you are only required to enter the first four digits of the objects six digit SAO number. Once the first four digits are entered, the hand control will automatically list all the available SAO objects beginning with those numbers. This allows you to scroll through only the SAO stars in the database. For example, in searching for the SAO star 40186 (Capella), the first four digits would be "0401". Entering this number will display the closest match from the SAO stars available in the database. From there you can scroll down the list and select the desired object.

## ***Slewing to an Object***

Once the desired object is displayed on the hand control screen, you have two options:

- **Press the INFO Key.** This will give you useful information about the selected object such as magnitude, constellation and fascinating facts about many of the objects.
- **Press the ENTER Key.** This will automatically slew the telescope to the coordinates of the object. While the telescope is slewing to the object, the user can still access many of the hand control functions (such as displaying information about the object).

*If you slew to an object that is below the horizon, LCM will notify you by displaying a message reminding you that you have selected an object outside of your slew limits (see Slew Limits in the Scope Setup section of the manual). Press UNDO to go back and select a new object. Press ENTER to ignore the message and continue the slew. The LCM hand control will only display objects that are below the horizon if the Filter Limits are set below 0° in altitude. See Filter Limits in the Utility Feature section of the manual for more information on setting the filter limits.*

**Caution:** Never slew the telescope when someone is looking into the eyepiece. The telescope can move at fast slew speeds and may hit an observer in the eye.

Object information can be obtained without having to do a star alignment. After the telescope is powered on, pressing any of the catalog keys allows you to scroll through object lists or enter catalog numbers and view the information about the object as described above.

## ***Finding Planets***

The LCM can locate all 8 of our solar systems planets (including Pluto) plus the Sun and Moon. However, the hand control will only display the solar system objects that are above the horizon (or within its filter limits). To locate the planets, press the PLANET key on the hand control. The hand control will display all solar system objects that are above the horizon:

- Use the **Up** and **Down** keys to select the planet that you wish to observe.
- Press **INFO** to access information on the displayed planet.
- Press **ENTER** to slew to the displayed planet.

To allow the Sun to be displayed as an option in the database, see *Sun Menu* in the Utilities section of the manual.

## ***Tour Mode***

The LCM includes a tour feature which automatically allows the user to choose from a list of interesting objects based on the date and time in which you are observing. The automatic tour will display only those objects that are within your set filter limits. To activate the Tour mode, press the TOUR key on the hand control. The LCM will display the best objects to observe that are currently in the sky.

- To see information and data about the displayed object, press the INFO key.
- To slew to the object displayed, press ENTER.
- To see the next tour object, press the Down key.

## ***Constellation Tour***

In addition to the Tour Mode, the LCM telescope has a Constellation Tour that allows the user to take a tour of all the best objects within a particular constellation. Selecting *Constellation* from the LIST menu will display all the constellation names that are above the user defined horizon (filter limits). Once a constellation is selected, you can choose from any of the database object catalogs to produce a list of all the available objects in that constellation.

- To see information and data about the displayed object, press the INFO key.
- To slew to the object displayed, press ENTER.
- To see the next tour object, press the Up key.

## Direction Buttons

The LCM has four direction buttons in the center of the hand control which controls the telescope motion in altitude (up and down) and azimuth (left and right). The telescope can be controlled at nine different speed rates.

|                                   |                   |
|-----------------------------------|-------------------|
| $1 = 2x$                          | $6 = 64x$         |
| $2 = 4x$                          | $7 = 1^\circ/sec$ |
| $3 = 8x$                          | $8 = 2^\circ/sec$ |
| $4 = 16x$                         | $9 = 3^\circ/sec$ |
| $5 = 32x$                         |                   |
| <b>Nine available slew speeds</b> |                   |

## Rate Button

Pressing the RATE key (11) allows you to instantly change the speed rate of the motors from high speed slew rate to precise guiding rate or anywhere in between. Each rate corresponds to a number on the hand controller key pad. The number 9 is the fastest rate (approximately  $3^\circ$  per second, depending on power source) and is used for slewing between objects and locating alignment stars. The number 1 on the hand control is the slowest rate ( $2x$  sidereal) and can be used for accurate centering of objects in the eyepiece. To change the speed rate of the motors:

- Press the RATE key on the hand control. The LCD will display the current speed rate.
- Press the number on the hand control that corresponds to the desired speed.

The hand control has a "double button" feature that allows you to instantly speed up the motors without having to choose a speed rate. To use this feature, simply press the arrow button that corresponds to the direction that you want to move the telescope. While holding that button down, press the opposite directional button. This will increase the speed to the maximum slew rate.

## Set Up Procedures

The LCM contains many user defined setup functions designed to give the user control over the telescope's many advanced features. All of the set up and utility features can be accessed by pressing the MENU key and scrolling through the options:

**Tracking Mode** Once the LCM is aligned the tracking motors will automatically turn on and begin tracking the sky. However, the tracking can be turned off for terrestrial use:

**Alt-Az** This is the default tracking rate and is used when the telescope has been properly aligned.

**EQ North** Used to track the sky when the telescope is polar aligned using an equatorial wedge in the Northern Hemisphere.

**EQ South** Used to track the sky when the telescope is polar aligned using an equatorial wedge in the Southern Hemisphere.

**Off** When using the telescope for terrestrial (land) observation the tracking can be turned off so that the telescope never moves.

**Note:** EQ North and EQ South tracking modes are only needed with telescopes that can be polar aligned. The LCM series are exclusively Alt-Az mounted telescopes and do not require equatorial tracking.

**Tracking Rate** - In addition to being able to move the telescope with the hand control buttons, the LCM will continually track a celestial object as it moves across the night sky. The tracking rate can be changed depending on what type of object is being observed:

**Sidereal** This rate compensates for the rotation of the earth by moving the telescope at the same rate as the rotation of the earth, but in the opposite direction. When tracking in Alt-Az mode, the telescope must make corrections in both altitude and azimuth.

**Lunar** Used for tracking the moon when observing the lunar landscape.

**Solar** Used for tracking the Sun when solar observing using a proper solar filter.

**View Time-Site** - *View Time-Site* will display the last saved time and longitude/latitude entered in the hand control.

**User Defined Objects** - The LCM can store up to 50 different user defined objects in its memory. The objects can be daytime land objects or an interesting celestial object that you discover that is not included in the regular database. There are several ways to save an object to memory depending on what type of object it is:

**Save Sky Object:** The LCM stores celestial objects to its database by saving its right ascension and declination in the sky. This way the same object can be found each time the telescope is aligned. Once a desired object is centered in the eyepiece, simply scroll to the "**Save Sky Obj**" command and press ENTER. The display will ask you to enter a number between 1-25 to identify the object. Press ENTER again to save this object to the database.

**Save Database (Db) Object:**

This feature allows you to create your own custom tour of database objects by allowing you to record the current position of the telescope and save the name of the object by selecting it from any one of the database catalogs. These objects then can be accessed by selecting *GoTo Sky Object*.

**Save Land Object:**

The LCM can also be used as a spotting scope on terrestrial objects. Fixed land objects can be stored by saving their altitude and azimuth relative to the location of the telescope at the time of observing. Since these objects are relative to the location of the telescope, they are only valid for that exact location. To save land objects, once again center the desired object in the eyepiece. Scroll down to the "**Save Land Obj**" command and press ENTER. The display will ask you to enter a number between 1-25 to identify the object. Press ENTER again to save this object to the database.

**Enter R.A. - Dec:**

You can also store a specific set of coordinates for an object just by entering the R.A. and declination for that object. Scroll to the "**Enter RA-DEC**" command and press ENTER. The display will then ask you to enter first the R.A. and then the declination of the desired object.

**GoTo Object:**

To go to any of the user defined objects stored in the database, scroll down to either **GoTo Sky Obj** or **GoTo Land Obj** and enter the number of the object you wish to select and press ENTER. The hand control will automatically retrieve and display the coordinates before slewing to the object.

To replace the contents of any of the user defined objects, simply save a new object using one of the existing identification numbers; LCM will replace the previous user defined object with the current one.

**Get R.A./DEC.** - Displays the right ascension and declination for the current position of the telescope.

**Goto R.A./ DEC.** - Allows you to input a specific R.A. and declination and slew to it.

## Identify

*Identify Mode* will search any of the LCM database catalogs or lists and display the name and offset distances to the nearest matching objects. This feature can serve two purposes. First, it can be used to identify an unknown object in the field of view of your eyepiece. Additionally, *Identify Mode* can be used to find other celestial objects that are close to the objects you are currently observing. For example, if your telescope is pointed at the brightest star in the constellation Lyra, choosing *Identify* and then searching the *Named Star* catalog will no doubt return the star Vega as the star you are observing. However, by selecting *Identify* and searching by the *Named Object* or *Messier* catalogs, the hand control will let you know that the Ring Nebula (M57) is approximately 6° from your current position. Searching the Double Star catalog will reveal that Epsilon Lyrae is only 1° away from Vega. To use the *Identify* feature:

- Press the Menu button and select the Identify option.
- Use the Up/Down scroll keys to select the catalog that you would like to search.
- Press ENTER to begin the search.

**Note: Some of the databases contain thousands of objects, and can therefore take a minute or two to return the closest object.**

## Scope Setup Features

*Setup Time-Site* - Allows the user to customize the hand control display by changing time and location parameters (such as time zone and daylight savings).

*Anti-backlash* – All mechanical gears have a certain amount of backlash or play between the gears. This play is evident by how long it takes for a star to move in the eyepiece when the hand control arrow buttons are pressed (especially when changing directions). The LCM's anti-backlash features allows the user to compensate for backlash by inputting a value which quickly rewinds the motors just enough to eliminate the play between gears. The amount of compensation needed depends on the slewing rate selected; the slower the slewing rate the longer it will take for the star to appear to move in the eyepiece. Therefore, the anti-backlash compensation will have to be set higher. You will need to experiment with different values; a value between 20 and 50 is usually best for most visual observing, whereas a higher value may be necessary for photographic guiding. Positive backlash compensation is applied when the mount changes its direction of movement from backwards to forwards. Similarly, negative backlash compensation is applied when the mount changes its direction of movement from forwards to backwards. When tracking is enabled, the mount will be moving in one or both axes in either the positive or negative direction, so backlash compensation will always be applied when a direction button is released and the direction moved is opposite to the direction of travel.

To set the anti-backlash value, scroll down to the anti-backlash option and press ENTER. Enter a value from 0-100 for both azimuth and altitude directions and press ENTER after each one to save these values. The LCM will remember these values and use them each time it is turned on until they are changed.

*Slew Limits* – Sets the limits in altitude that the telescope can slew without displaying a warning message. The slew limits prevent the telescope tube from slewing to an object below the horizon or slewing to an object that is high enough that the tube might hit one of the tripod legs. However, the slew limits can be customized depending on your needs. For example, if you would like to slew to an object that is close to the zenith and are certain that the tube will not hit the tripod legs, you can set the slew limits to 90° in altitude. This will allow the telescope to slew to any object above the horizon without warning.

*Filter Limits* – When an alignment is complete, the LCM automatically knows which celestial objects are above the horizon. As a result, when scrolling through the database lists (or selecting the Tour function), the LCM hand control will display only those objects that are known to be above the horizon when you are observing. You can customize the object database by selecting altitude limits that are appropriate for your location and situation. For example, if you are observing from a mountainous location where the horizon is partially obscured, you can set your minimum altitude limit to read +20°. This will make sure that the hand control only displays objects that are higher in altitude than 20°.

### Observing Tip!

*If you want to explore the entire object database, set the maximum altitude limit to 90° and the minimum limit to -90°. This will display every object in the database lists regardless of whether it is visible in the sky from your location or not.*

*Direction Buttons* – The direction a star moves in the eyepiece varies depending on the accessories being used. This can create confusion when guiding on a star using an off-axis guider versus a straight through guide scope. To compensate for this, the direction of the drive control keys can be changed. To reverse the button logic of the hand

control, press the MENU button and select *Direction Buttons* from the Utilities menu. Use the Up/Down arrow keys (10) to select either the Azimuth buttons (left and right) or Altitude buttons (up and down) and press ENTER. Pressing ENTER again will reverse the direction of the hand control buttons from their current state. Direction Buttons will only change the eyepiece rates (rate 1-6) and will not affect the slew rates (rate 7-9).

**Goto Approach** – lets the user define the direction that the telescope will approach when slewing to an object. This allows the user the ability to minimize the effects of backlash. For example, if your telescope is back heavy from using heavy optical or photographic accessories attached to the back, you would want to set your altitude approach to the negative direction. This would ensure that the telescope always approaches an object from the opposite direction as the load pulling on the scope.

To change the goto approach direction, simply choose *Goto Approach* from the *Scope Setup* menu, select either Altitude or Azimuth approach, choose positive or negative and press Enter.

**Cordwrap** – Cord wrap safeguards against the telescope slewing more than 360° in azimuth and wrapping accessory cables around the base of the telescope. This is useful any time that the telescope is powered using an external power supply. By default, the cord wrap feature is turned off when the telescope is aligned in altazimuth and turn on when aligned on a wedge.

## Utility Features

Scrolling through the MENU options will also provide access to several advanced utility functions such as anti-backlash compensation and slew limits.

**GPS On/Off** – This feature is only available when using your telescope in conjunction with the optional CN 16 GPS accessory. Allows you to turn off the GPS module. If you want to use the LCM database to find the coordinates of a celestial object for a future date you would need to turn the GPS module off in order to manually enter a date and time other than the present.

**Light Control** – This feature allows you to turn off both the red key pad light and LCD display for daytime use to conserve power and to help preserve your night vision.

**Factory Setting** – Returns the LCM hand control to its original factory setting. Parameters such as backlash compensation values, initial date and time, longitude/latitude along with slew and filter limits will be reset. However, stored parameters such as PEC and user defined objects will remain saved even when *Factory Settings* is selected. The hand control will ask you to press the "0" key before returning to the factory default setting.

**Version** – Selecting this option will allow you to see the current version number of the hand control and motor control software. The first set of numbers indicate the hand control software version. For the motor control, the hand control will display two sets of numbers; the first numbers are for azimuth and the second set are for altitude.

**Get Axis Position** – Displays the relative altitude and azimuth for the current position of the telescope.

**Goto Axis Position** – Allows you to enter a specific altitude and azimuth position and slew to it.

**Hibernate** – Hibernate allows the LCM to be completely powered down and still retain its alignment when turned back on. This not only saves power, but is ideal for those that have their telescopes permanently mounted or leave their telescope in one location for long periods of time. To place your telescope in Hibernate mode:

1. Select Hibernate from the Utility Menu.
2. Move the telescope to a desire position and press ENTER.
3. Power off the telescope. Remember to never move your telescope manually while in Hibernate mode.

Once the telescope is powered on again the display will read Wake Up. After pressing Enter you have the option of scrolling through the time/site information to confirm the current setting. Press ENTER to wake up the telescope.

*Pressing UNDO at the Wake Up screen allows you to explore many of the features of the hand control without waking the telescope up from hibernate mode. To wake up the telescope after UNDO has been pressed, select Hibernate from the Utility menu and press ENTER. Do not use the direction buttons to move the telescope while in hibernate mode.*



Helpful  
Hint

## ***Sun Menu***

For safety purposes the Sun will not be displayed as a database object unless it is first enabled. To enable the Sun, go to the *Sun Menu* and press ENTER. The Sun will now be displayed in the Planets catalog and can be used as an alignment object when using the Solar System Alignment method. To remove the Sun from displaying on the hand control, once again select the Sun Menu from the Utilities Menu and press ENTER.

## ***Scrolling Menu***

This menu allows you to change the rate of speed that the text scrolls across the hand control display.

- Press the Up (number 6) button to increase the speed of the text.
- Press the Down (number 9) button to decrease the speed of the text.

## ***Calibrate Goto***

Goto Calibration is a useful tool when attaching heavy visual or photographic accessories to the telescope. Goto Calibration calculates the amount of distance and time it takes for the mount to complete its final slow goto when slewing to an object. Changing the balance of the telescope can prolong the time it takes to complete the final slew. Goto Calibration takes into account any slight imbalances and changes the final goto distance to compensate.

## ***Set Mount Position***

The Set Mount Position menu can be used to recover an alignment in cases where the telescope or tripod has been manually moved. For instance, you might use this feature if you needed to adjust the level of the tripod by raising or lowering the tripod legs. After the mount has been moved, simply slew to a bright star and center it up in the eyepiece, then select *Set Mount Position* from the Utilities menu. Since the telescope has been moved, the pointing accuracy will be diminished. But now you can slew to a new set of alignment stars and replace any of the original alignment stars with the new stars. This will help you to avoid having to start the alignment process over from the beginning.

LCM Ready

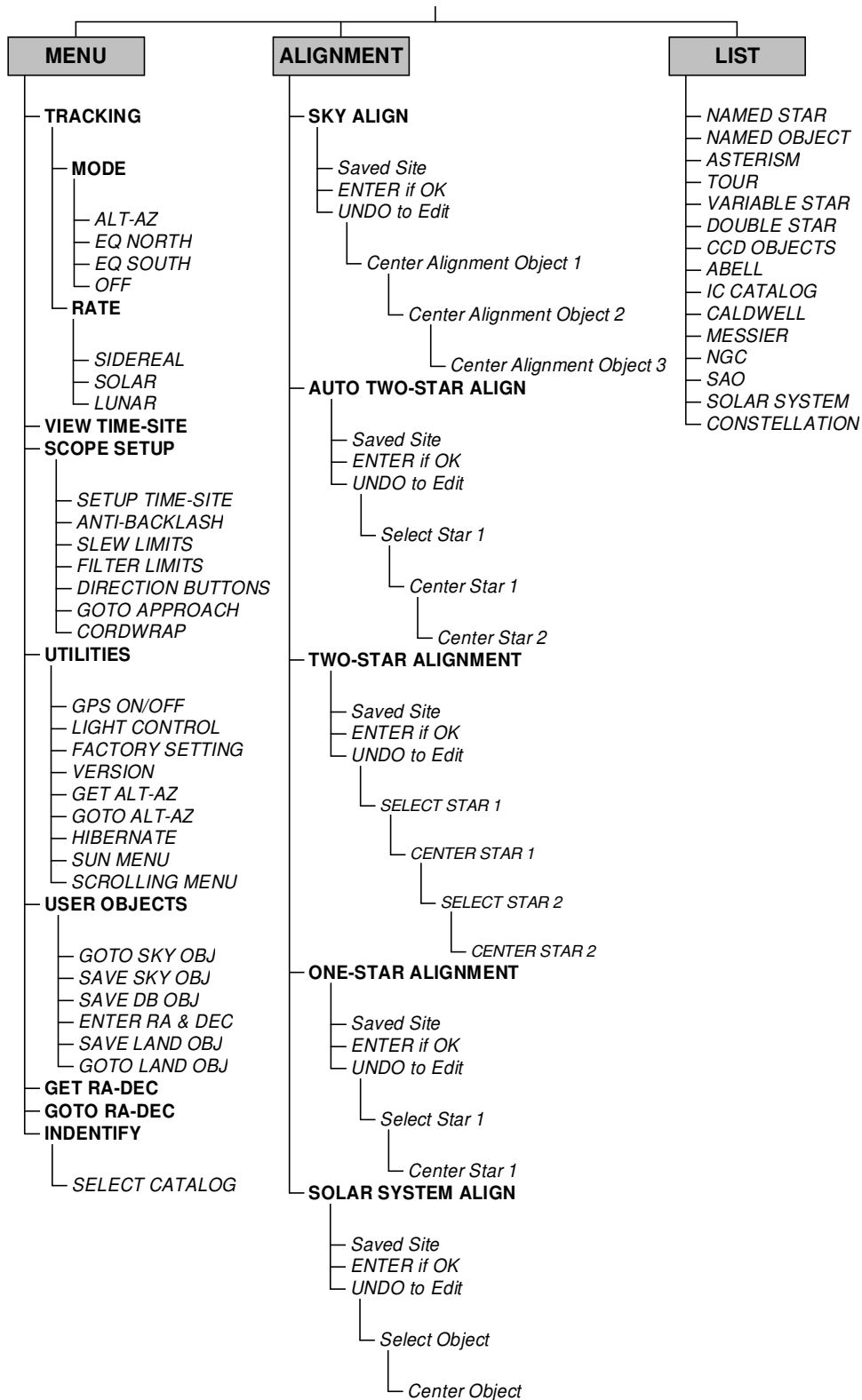

**Hand Control Menu Tree:**

The following figure is a menu tree showing the sub-menus associated with the primary command functions

# CELESTRON® Telescope Basics

A telescope is an instrument that collects and focuses light. The nature of the optical design determines how the light is focused. Some telescopes, known as refractors, use lenses. Other telescopes, known as reflectors, use mirrors. The LCM 114 is a reflecting telescopes with a primary and secondary mirror to gather and focus light.

## Focusing

Once you have found an object in the telescope, turn the focusing knob until the image is sharp. To focus on an object that is nearer than your current target, turn the focusing knob toward the eyepiece (i.e., so that the focusing tube moves away from the front of the telescope). For more distant objects, turn the focusing knob in the opposite direction. To achieve a truly sharp focus, never look through glass windows or across objects that produce heat waves, such as asphalt parking lots.

## Image Orientation

The image orientation of any telescope changes depending on how the eyepiece is inserted into the telescope.

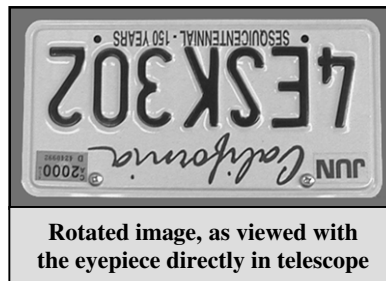

When observing through the LCM 114, a reflecting telescope, the image will correct, but rotated when looking through the eyepiece.

For astronomical viewing, out of focus star images are very diffuse, making them difficult to see. If you turn the focus knob too quickly, you can go right through focus without seeing the image. To avoid this problem, your first astronomical target should be a bright object (like the Moon or a planet) so that the image is visible even when out of focus.

## Calculating Magnification

You can change the power of your telescope just by changing the eyepiece (ocular). To determine the magnification of your telescope, simply divide the focal length of the telescope by the focal length of the eyepiece used. In equation format, the formula looks like this:

$$\text{Magnification} = \frac{\text{Focal Length of Telescope (mm)}}{\text{Focal Length of Eyepiece (mm)}}$$

Let's say, for example, you are using the 25mm eyepiece. To determine the magnification you simply divide the focal length of your telescope (for example, the LCM 114 has a focal length of 1000mm) by the focal length of the eyepiece, 25mm. Dividing 1000 by 25 yields a magnification of 40 power.

Although the power is variable, each instrument under average skies has a limit to the highest useful magnification. The general rule is that 60 power can be used for every inch of aperture. For example, the LCM 114 is 4.5" (114mm) in diameter. Multiplying 4.5 by 60 gives a maximum useful magnification of 270 power. Although this is the maximum useful magnification, most observing is done in the range of 20 to 35 power for every inch of aperture which is 90 to 158 times for the LCM 114 telescope.

## Determining Field of View

Determining the field of view is important if you want to get an idea of the angular size of the object you are observing. To calculate the actual field of view, divide the apparent field of the eyepiece (supplied by the eyepiece manufacturer) by the magnification. In equation format, the formula looks like this:

$$\text{True Field} = \frac{\text{Apparent Field of Eyepiece}}{\text{Magnification}}$$

As you can see, before determining the field of view, you must calculate the magnification. Using the example in the previous section, we can determine the field of view using the same 25mm eyepiece. The 25mm eyepiece has an apparent field of view of 50°. Divide the 50° by the magnification, which is 40 power. This yields an actual field of view of 1.25°.

To convert degrees to feet at 1,000 yards, which is more useful for terrestrial observing, simply multiply by 52.5. Continuing with our example, multiply the angular field 1.4° by 52.5. This produces a linear field width of 66 feet at a distance of one thousand yards. The apparent field of each eyepiece that Celestron manufactures is found in the Celestron Accessory Catalog (#93685).

## General Observing Hints

When working with any optical instrument, there are a few things to remember to ensure you get the best possible image:

- Never look through window glass. Glass found in household windows is optically imperfect, and as a result, may vary in thickness from one part of a window to the next. This inconsistency can and will affect the ability to focus your telescope. In most cases you will not be able to achieve a truly sharp image, while in some cases, you may actually see a double image.
- Never look across or over objects that are producing heat waves. This includes asphalt parking lots on hot summer days or building rooftops.
- Hazy skies, fog, and mist can also make it difficult to focus when viewing terrestrially. The amount of detail seen under these conditions is greatly reduced. Also, when photographing under these conditions, the processed film may come out a little grainier than normal with lower contrast and underexposed.
- If you wear corrective lenses (specifically glasses), you may want to remove them when observing with an eyepiece attached to the telescope. When using a camera, however, you should always wear corrective lenses to ensure the sharpest possible focus. If you have astigmatism, corrective lenses must be worn at all times.

# **CELESTRON** **Celestial Observing**

With your telescope set up, you are ready to use it for observing. This section covers visual observing hints for both solar system and deep sky objects as well as general observing conditions which will affect your ability to observe.

## **Observing the Moon**

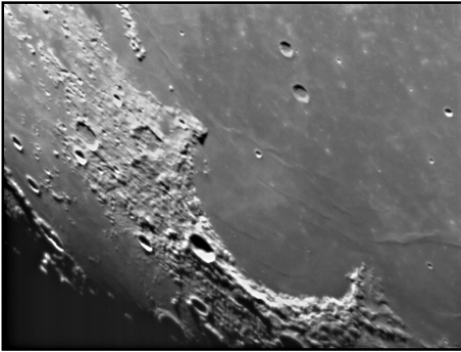

Often, it is tempting to look at the Moon when it is full. At this time, the face we see is fully illuminated and its light can be overpowering. In addition, little or no contrast can be seen during this phase.

One of the best times to observe the Moon is during its partial phases (around the time of first or third quarter). Long shadows reveal a great amount of detail on the lunar surface. At low power you will be able to see most of the lunar disk at one time. Change to higher power (magnification) to focus in on a smaller area. Choose the *lunar* tracking rate from the hand control's MENU tracking rate options to keep the moon centered in the eyepiece even at high magnifications.

## **Lunar Observing Hints**

- To increase contrast and bring out detail on the lunar surface, use eyepiece filters. A yellow filter works well at improving contrast while a neutral density or polarizing filter will reduce overall surface brightness and glare.

## **Observing the Planets**

Other fascinating targets include the five naked eye planets. You can see Venus go through its lunar-like phases. Mars can reveal a host of surface detail and one, if not both, of its polar caps. You will be able to see the cloud belts of Jupiter and the great Red Spot (if it is visible at the time you are observing). In addition, you will also be able to see the moons of Jupiter as they orbit the giant planet. Saturn, with its beautiful rings, is easily visible at moderate power.

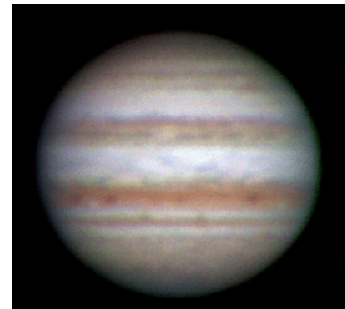

## **Planetary Observing Hints**

- Remember that atmospheric conditions are usually the limiting factor on how much planetary detail will be visible. So, avoid observing the planets when they are low on the horizon or when they are directly over a source of radiating heat, such as a rooftop or chimney. See the "*Seeing Conditions*" section later in this section.
- To increase contrast and bring out detail on the planetary surface, try using Celestron eyepiece filters.

## **Observing the Sun**

Although overlooked by many amateur astronomers, solar observation is both rewarding and fun. However, because the Sun is so bright, special precautions must be taken when observing our star so as not to damage your eyes or your telescope.

**Never project an image of the Sun through the telescope. Tremendous heat build-up may result inside the optical tube. This can damage the telescope and/or any accessories attached to the telescope.**

For safe solar viewing, use a Celestron solar filter (see *Optional Accessories* section of manual) that reduces the intensity of the Sun's light, making it safe to view. With a filter you can see sunspots as they move across the solar disk and faculae, which are bright patches seen near the Sun's edge.

## **Solar Observing Hints**

- The best time to observe the Sun is in the early morning or late afternoon when the air is cooler.
- To center the Sun without looking into the eyepiece, watch the shadow of the telescope tube until it forms a circular shadow.
- To ensure accurate tracking on LCM models, be sure to select solar tracking rate.

## **Observing Deep Sky Objects**

Deep sky objects are simply those objects outside the boundaries of our solar system. They include star clusters, planetary nebulae, diffuse nebulae, double stars and other galaxies outside our own Milky Way. Most deep sky objects have a large angular size. Therefore, low-to-moderate power is all you need to see them. Visually, they are too faint to reveal any of the color seen in long exposure photographs. Instead, they appear black and white. And, because of their low surface brightness, they should be observed from a dark sky location. Light pollution around large urban areas washes out most nebulae making them difficult, if not impossible, to observe. Light Pollution Reduction filters help reduce the background sky brightness, thus increasing contrast.

## **Seeing Conditions**

Viewing conditions affect what you can see through your telescope during an observing session. Conditions include transparency, sky illumination, and seeing. Understanding viewing conditions and the effect they have on observing will help you get the most out of your telescope.

## **Transparency**

Transparency is the clarity of the atmosphere which is affected by clouds, moisture, and other airborne particles. Thick cumulus clouds are completely opaque while cirrus can be thin, allowing the light from the brightest stars through. Hazy skies absorb more light than clear skies making fainter objects harder to see and reducing contrast on brighter objects. Aerosols ejected into the upper atmosphere from volcanic eruptions also affect transparency. Ideal conditions are when the night sky is inky black.

## **Sky Illumination**

General sky brightening caused by the Moon, aurorae, natural airglow, and light pollution greatly affect transparency. While not a problem for the brighter stars and planets, bright skies reduce the contrast of extended nebulae making them difficult, if not impossible, to see. To maximize your observing, limit deep sky viewing to moonless nights far from the light polluted skies found around major urban areas. LPR filters enhance deep sky viewing from light polluted areas by blocking unwanted light while transmitting light from certain deep sky objects. You can, on the other hand, observe planets and stars from light polluted areas or when the Moon is out.

## Seeing

Seeing conditions refers to the stability of the atmosphere and directly affects the amount of fine detail seen in extended objects. The air in our atmosphere acts as a lens which bends and distorts incoming light rays. The amount of bending depends on air density. Varying temperature layers have different densities and, therefore, bend light differently. Light rays from the same object arrive slightly displaced creating an imperfect or smeared image. These atmospheric disturbances vary from time-to-time and place-to-place. The size of the air parcels compared to your aperture determines the "seeing" quality. Under good seeing conditions, fine detail is visible on the brighter planets like Jupiter and Mars, and stars are pinpoint images. Under poor seeing conditions, images are blurred and stars appear as blobs.

The conditions described here apply to both visual and photographic observations.

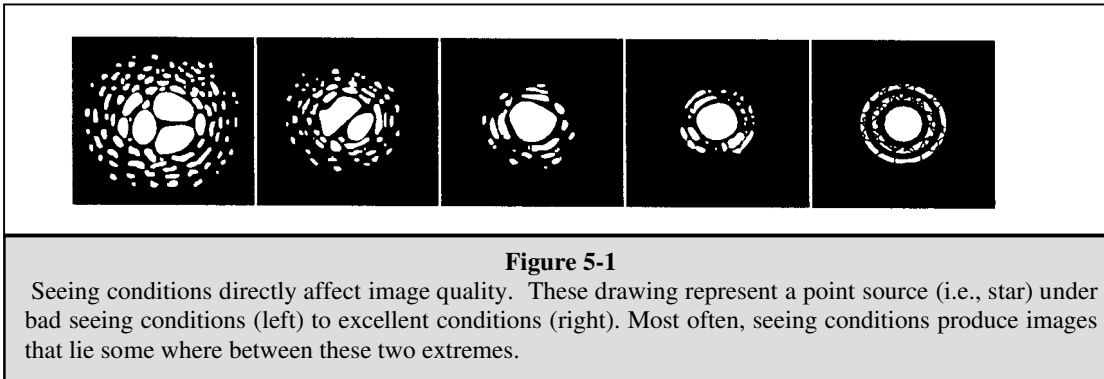

# **CELESTRON** **Telescope Maintenance**

While your LCM telescope requires little maintenance, there are a few things to remember that will ensure your telescope performs at its best.

## **Care and Cleaning of the Optics**

Occasionally, dust and/or moisture may build up on the lens of your telescope. Special care should be taken when cleaning any instrument so as not to damage the optics.

If dust has built up on the optics, remove it with a brush (made of camel's hair) or a can of pressurized air. Spray at an angle to the lens for approximately two to four seconds. Then, use an optical cleaning solution and white tissue paper to remove any remaining debris. Apply the solution to the tissue and then apply the tissue paper to the lens. Low pressure strokes should go from the center of the corrector to the outer portion. **Do NOT rub in circles!**

You can use a commercially made lens cleaner or mix your own. A good cleaning solution is isopropyl alcohol mixed with distilled water. The solution should be 60% isopropyl alcohol and 40% distilled water. Or, liquid dish soap diluted with water (a couple of drops per one quart of water) can be used.

To minimize the need to clean your telescope, replace all lens covers once you have finished using it. This will prevent contaminants from entering the optical tube.

## **Collimation**

The optical performance of your LCM telescope is directly related to its collimation, that is the alignment of its optical system. Your telescope was collimated at the factory after it was completely assembled. However, if the telescope is dropped or jarred severely during transport, it may have to be collimated. The LCM 114 however has three collimation screws that can be used to adjust the alignment of the primary mirror.

To check if your telescope is in collimation the following diagram will help you. If you look into the eyepiece adapter (without an eyepiece) at the top of the focuser, this is what you should see. If the reflection of your eye is off center, then collimation is necessary.

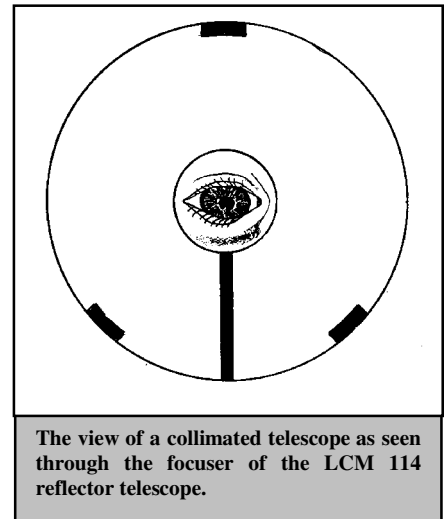

## **Aligning the Secondary Mirror**

The following describes the procedure for daytime collimation of your telescope using the optional Newtonian Collimation Tool (#94183) offered by Celestron.

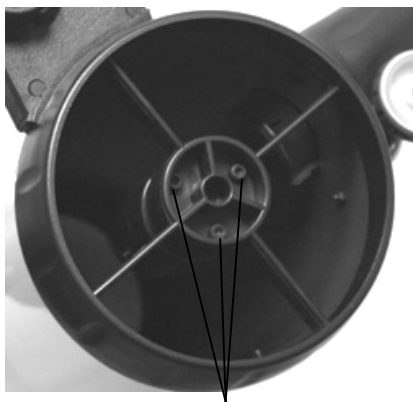

**Secondary Mirror  
Collimation Screws**

For very precise collimation, the optional Collimation Eyepiece 1 1/4" (# 94182) is offered.

If you have an eyepiece in the focuser, remove it. Using the focusing knobs, rack the focuser tube in completely. You will be looking through the focuser at a reflection of the secondary mirror, projected from the primary mirror. During this step, ignore the silhouetted reflection from the primary mirror. Insert the collimating cap into the focuser and look through it. With the focus pulled in all the way, you should be able to see the entire primary mirror reflected in the secondary mirror. If the primary mirror is not centered in the secondary mirror, adjust the secondary mirror screws by alternately tightening and loosening them until the periphery of the primary mirror is centered in your view. **DO NOT** loosen or tighten the center screw in the secondary mirror support, because it maintains proper mirror position.

## Aligning the Primary Mirror

Now adjust the primary mirror screws to re-center the reflection of the small secondary mirror, so its silhouetted against the view of the primary. As you look into the focuser, silhouettes of the mirrors should look concentric. Repeat steps one and two until you have achieved this. Remove the collimating cap and look into the focuser, where you should see the reflection of your eye in the secondary mirror.

### Newtonian collimation views as seen through the focuser using the collimation cap

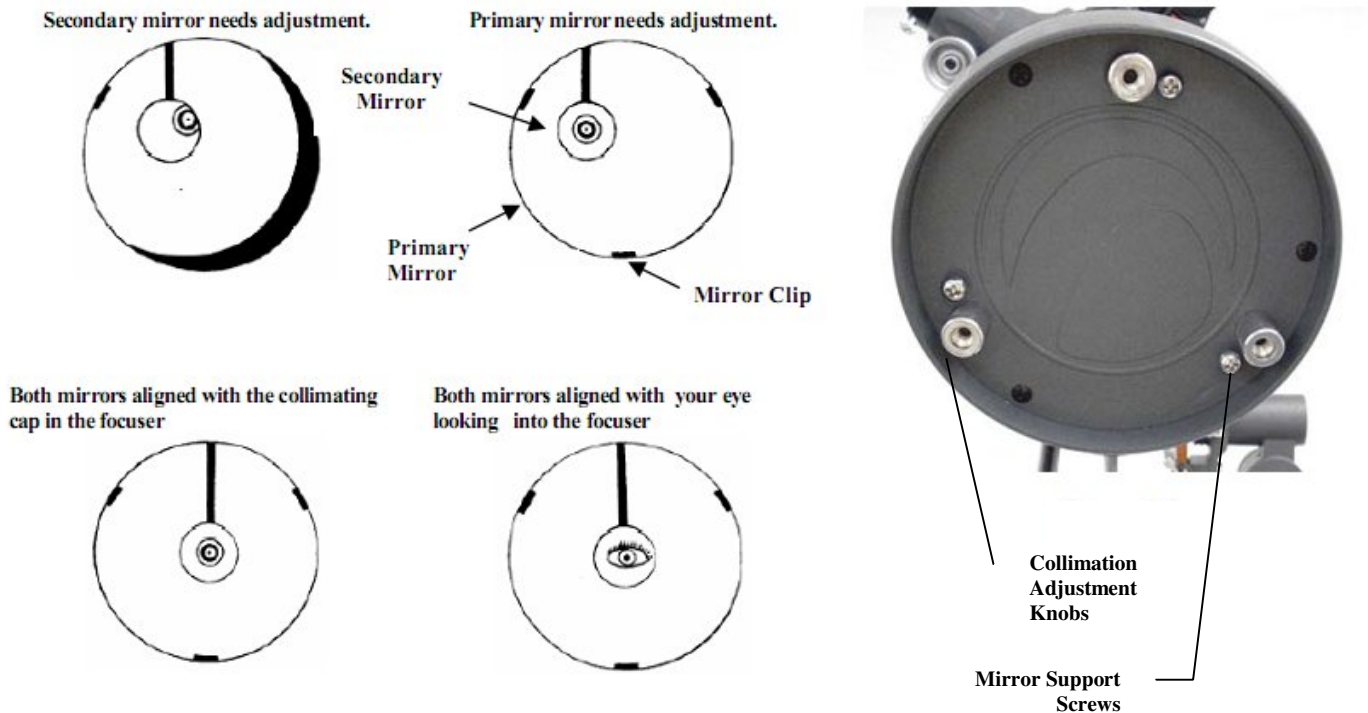

Adjustments to the collimation of the telescope can be made by turning the collimation adjustment knobs located at the rear of the optical tube. First loosen the three Phillips head screws on the rear cell of the tube. Turn each collimation knobs, one at a time, until the reflected image of your eye in the secondary mirror is centered in the primary mirror. Once the telescope is collimated, tighten the Phillips head screws until you feel a slight resistance. Do not over tighten the screw.

If your telescope is out of collimation, the best way to re-collimate it is with a good collimation tool. Celestron offers a Newtonian Collimation Tool (#94183) with detailed instructions that make it an easy chore.



# CELESTRON Optional Accessories

You will find that additional accessories enhance your viewing pleasure and expand the usefulness of your telescope. For ease of reference, all the accessories are listed in alphabetical order.

**Adapter, Car Battery (#18769)** – Celestron offers the Car Battery Adapter that allows you to run the LCM drive off an external power source. The adapter attaches to the cigarette lighter of your car, truck, van, or motorcycle.

**Barlow lens, OMNI 1.25" (#93326)** – Double the magnification of any of your Celestron eyepieces with this fully multi-coated, low profile Barlow lens

**Eyepieces** – Like telescopes, eyepieces come in a variety of designs. Each design has its own advantages and disadvantages. For the 1-1/4" barrel diameter there are four different eyepiece designs available:

- **OMNI Plössl** – Plössl eyepieces have a 4-element lens designed for low-to-high power observing. The Plössls offer razor sharp views across the entire field, even at the edges! In the 1-1/4" barrel diameter, they are available in the following focal lengths: 4mm, 6mm, 9mm, 12.5mm, 15mm, 20mm, 32mm and 40mm.
- **X-Cel** – This 6 element design allows each X-Cel Eyepiece to have 20mm of eye relief, 55° field of view and more than 25mm of lens aperture (even with the 2.3mm). In order to maintain razor sharp, color corrected images across its 50° field of view, extra-low dispersion glass is used for the most highly curved optical elements. The excellent refractive properties of these high grade optical elements make the X-Cel line especially well suited for high magnification planetary viewing where sharp, color-free views are most appreciated. X-Cel eyepiece come in the following focal length: 2.3mm, 5mm, 8mm, 10mm, 12.5mm, 18mm, 21mm, 25mm.



**Flashlight, Night Vision – (#93588)** - Celestron's premium model for astronomy, using two red LEDs to preserve night vision better than red filters or other devices. Brightness is adjustable. Operates on a single 9 volt battery (included).



UHC/LPR Filter -  
#94123

**Filter, Light Pollution Reduction – UHC/LPR (#94123)** – These filters are designed to enhance your views of deep sky astronomical objects when viewed from urban areas. LPR Filters selectively reduce the transmission of certain wavelength of light, specifically those produced by artificial lights. This includes mercury and high and low pressure sodium vapor lights. In addition, they also block unwanted natural light (sky glow) caused by neutral oxygen emission in our atmosphere.

**Filter, Solar (#94229)**– The AstroSolar® filter is a safe and durable filter that covers the front opening of the telescope. View sunspots and other solar features using this double-sided metal coated filter for uniform density and good color balance across the entire field. The Sun offers constant changes and will keep your observing interesting and fun.

**PowerTank (#18774)** – 12 V 7Amp hour rechargeable power supply. Comes with two 12v output cigarette outlets, built-in red flash light, Halogen emergency spotlight. AC adapter and cigarette lighter adapter included.



RS-232 Cable (#93920) – Allows your LCM telescope to be controlled using a laptop computer or PC. Once connected, the LCM can be controlled using popular astronomy software programs.

**Sky Maps (#93722)** – Celestron Sky Maps are the ideal teaching guide for learning the night sky. You wouldn't set off on a road trip without a road map, and you don't need to try to navigate the night sky without a map either. Even if you already know your way around the major constellations, these maps can help you locate all kinds of fascinating objects.

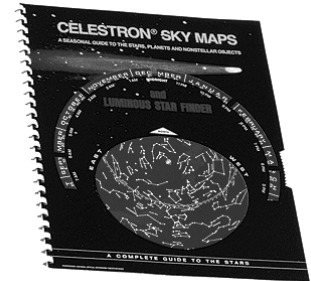

**Vibration Suppression Pads (#93503)** – These pads rest between the ground and tripod feet of your telescope. They reduce the amplitude and vibration time of your telescope when shaken by the wind or an accidental bump.

**A full description of all Celestron accessories can be found on our web site at [www.celestron.com](http://www.celestron.com)**

# APPENDIX A - TECHNICAL SPECIFICATIONS

## Optical Specification

|                                    |                          |
|------------------------------------|--------------------------|
|                                    | <b>LCM 114</b>           |
| Design                             | Reflector                |
| Aperture                           | 114mm                    |
| Focal Length                       | 1000mm                   |
| F/ratio of the Optical System      | 9                        |
| Optical Coatings                   | Aluminum                 |
| Highest Useful Magnification       | 269x                     |
| Resolution: Rayleigh Criterion     | 1.21 arc seconds         |
| Dawes Limit                        | 1.02 arc seconds         |
| Light Gathering Power              | 265x unaided eye         |
| Field of View: Standard Eyepiece   | 1.1°                     |
| Linear Field of View (at 1000 yds) | 59 feet                  |
| Eyepiece Magnification:            | 40x (25mm)<br>167x (6mm) |
| Optical Tube Length                | 18 inches                |

## Electronic Specifications

|                           |                              |
|---------------------------|------------------------------|
| Input Voltage             | 12 V DC Nominal              |
| Batteries Required        | 8 AA Alkaline                |
| Power Supply Requirements | 12 VDC-750 mA (Tip positive) |

## Mechanical Specifications

|              |  |
|--------------|--|
| Motor: Type  | DC Servo motors with encoders, both axes   |
| Resolution   | .691 arc sec   |
| Slew speeds  | Nine slew speeds: 3°/sec, 2°/sec, 1°/sec, .64x, 32x, 16x, 8x, 4x, 2x                   |
| Hand Control | Double line, 16 character Liquid Crystal Display<br>19 fiber optic backlit LED buttons |

## Software Specifications

|                              |  |
|------------------------------|--|
| Ports                        | RS-232 communication port on hand control  |
| Tracking Rates               | Sidereal, Solar and Lunar  |
| Tracking Modes               | Alt-Az, EQ North & EQ South  |
| Alignment Procedures         | Sky Align, Auto 2-Star, 2-Star, One-Star, Solar System Align                     |
| Database                     | 99 user defined programmable object.<br>Expanded information on over 100 objects |
| <b>Total Object Database</b> | <b>4,033 Objects</b>   |

# **GLOSSARY OF TERMS**

## **A-**

|                        |   |
|------------------------|---|
| Absolute magnitude     | The apparent magnitude that a star would have if it were observed from a standard distance of 10 parsecs, or 32.6 light-years. The absolute magnitude of the Sun is 4.8. at a distance of 10 parsecs, it would just be visible on Earth on a clear moonless night away from surface light.                              |
| Airy disk              | The apparent size of a star's disk produced even by a perfect optical system. Since the star can never be focused perfectly, 84 per cent of the light will concentrate into a single disk, and 16 per cent into a system of surrounding rings.  |
| Alt-Azimuth Mounting   | A telescope mounting using two independent rotation axes allowing movement of the instrument in Altitude and Azimuth.   |
| Altitude               | In astronomy, the altitude of a celestial object is its Angular Distance above or below the celestial horizon.  |
| Aperture               | The diameter of a telescope's primary lens or mirror; the larger the aperture, the greater the telescope's light-gathering power.   |
| Apparent Magnitude     | A measure of the relative brightness of a star or other celestial object as perceived by an observer on Earth.  |
| Arc minute             | A unit of angular size equal to 1/60 of a degree.   |
| Arc second             | A unit of angular size equal to 1/3,600 of a degree (or 1/60 of an arc minute).   |
| Asterism               | A small unofficial grouping of stars in the night sky.  |
| Asteroid               | A small, rocky body that orbits a star.   |
| Astrology              | The pseudoscientific belief that the positions of stars and planets exert an influence on human affairs; astrology has nothing in common with astronomy.  |
| Astronomical unit (AU) | The distance between the Earth and the Sun. It is equal to 149,597,900 km., usually rounded off to 150,000,000 km.  |
| Aurora                 | The emission of light when charged particles from the solar wind slams into and excites atoms and molecules in a planet's upper atmosphere.   |
| Azimuth                | The angular distance of an object eastwards along the horizon, measured from due north, between the astronomical meridian (the vertical line passing through the center of the sky and the north and south points on the horizon) and the vertical line containing the celestial body whose position is to be measured. |

## **B -**

|              |   |
|--------------|---|
| Binary Stars | Binary (Double) stars are pairs of stars that, because of their mutual gravitational attraction, orbit around a common center of mass. If a group of three or more stars revolve around one another, it is called a multiple system. It is believed that approximately 50 percent of all stars belong to binary or multiple systems. Systems with individual components that can be seen separately by a telescope are called visual binaries or visual multiples. The nearest "star" to our solar system, Alpha Centauri, is actually our nearest example of a multiple star system, it consists of three stars, two very similar to our Sun and one dim, small, red star orbiting around one another. |
|--------------|---|

## **C -**

|                   |  |
|-------------------|--|
| Celestial Equator | The projection of the Earth's equator on to the celestial sphere. It divides the sky into two equal hemispheres. |
| Celestial pole    | The imaginary projection of Earth's rotational axis north or south pole onto the celestial sphere.               |
| Celestial Sphere  | An imaginary sphere surrounding the Earth, concentric with the Earth's center.                                   |
| Collimation       | The act of putting a telescope's optics into perfect alignment.  |

## **D -**

|                   |   |
|-------------------|---|
| Declination (DEC) | The angular distance of a celestial body north or south of the celestial equator. It may be said to correspond to latitude on the surface of the Earth. |
|-------------------|---|

## **E -**

|                  |  |
|------------------|--|
| Ecliptic         | The projection of the Earth's orbit on to the celestial sphere. It may also be defined as "the apparent yearly path of the Sun against the stars".                           |
| Equatorial mount | A telescope mounting in which the instrument is set upon an axis which is parallel to the axis of the Earth; the angle of the axis must be equal to the observer's latitude. |

## **F -**

|              |  |
|--------------|--|
| Focal length | The distance between a lens (or mirror) and the point at which the image of an object at infinity is brought to focus. The focal length divided by the aperture of the mirror or lens is termed the focal ratio. |
|--------------|--|

## **G**

|      |  |
|------|--|
| GoTo | Term used to refer to a computerized telescope or to the act of slewing (moving) a computerized telescope. |
|------|--|

|                               |   |
|-------------------------------|---|
| <b>J -</b><br>Jovian Planets  | Any of the four gas giant planets that are at a greater distance from the sun than the terrestrial planets.   |
| <b>K -</b><br>Kuiper Belt     | A region beyond the orbit of Neptune extending to about 1000 AU which is a source of many short period comets.  |
| <b>L -</b><br>Light-Year (ly) | A light-year is the distance light traverses in a vacuum in one year at the speed of 299,792 km/ sec. With 31,557,600 seconds in a year, the light-year equals a distance of $9.46 \times 10^{12}$ km ( $5.87 \times 10^6$ trillion mi).  |
| <b>M -</b><br>Magnitude       | Magnitude is a measure of the brightness of a celestial body. The brightest stars are assigned magnitude 1 and those increasingly fainter from 2 down to magnitude 5. The faintest star that can be seen without a telescope is about magnitude 6. Each magnitude step corresponds to a ratio of 2.5 in brightness. Thus a star of magnitude 1 is 2.5 times brighter than a star of magnitude 2, and 100 times brighter than a magnitude 5 star. The brightest star, Sirius, has an apparent magnitude of -1.6, the full moon is -12.7, and the Sun's brightness, expressed on a magnitude scale, is -26.78. The zero point of the apparent magnitude scale is arbitrary. |
| Meridian                      | A reference line in the sky that starts at the North celestial pole and ends at the South celestial pole and passes through the zenith. If you are facing South, the meridian starts from your Southern horizon and passes directly overhead to the North celestial pole.   |
| Messier                       | A French astronomer in the late 1700's who was primarily looking for comets. Comets are hazy diffuse objects and so Messier cataloged objects that were not comets to help his search. This catalog became the Messier Catalog, M1 through M110.  |
| <b>N -</b><br>Nebula          | Interstellar cloud of gas and dust. Also refers to any celestial object that has a cloudy appearance.   |
| North Celestial Pole          | The point in the Northern hemisphere around which all the stars appear to rotate. This is caused by the fact that the Earth is rotating on an axis that passes through the North and South celestial poles. The star Polaris lies less than a degree from this point and is therefore referred to as the "Pole Star".   |
| Nova                          | Although Latin for "new" it denotes a star that suddenly becomes explosively bright at the end of its life cycle.   |
| <b>O -</b><br>Open Cluster    | One of the groupings of stars that are concentrated along the plane of the Milky Way. Most have an asymmetrical appearance and are loosely assembled. They contain from a dozen to many hundreds of stars.  |
| <b>P -</b><br>Parallax        | Parallax is the difference in the apparent position of an object against a background when viewed by an observer from two different locations. These positions and the actual position of the object form a triangle from which the apex angle (the parallax) and the distance of the object can be determined if the length of the baseline between the observing positions is known and the angular direction of the object from each position at the ends of the baseline has been measured. The traditional method in astronomy of determining the distance to a celestial object is to measure its parallax.   |
| Parfocal                      | Refers to a group of eyepieces that all require the same distance from the focal plane of the telescope to be in focus. This means when you focus one parfocal eyepiece all the other parfocal eyepieces, in a particular line of eyepieces, will be in focus.  |
| Parsec                        | The distance at which a star would show parallax of one second of arc. It is equal to 3.26 light-years, 206,265 astronomical units, or 30,800,000,000,000 km. (Apart from the Sun, no star lies within one parsec of us.)   |
| Point Source                  | An object which cannot be resolved into an image because it is too far away or too small is considered a point source. A planet is far away but it can be resolved as a disk. Most stars cannot be resolved as disks, they are too far away.  |
| <b>R -</b><br>Reflector       | A telescope in which the light is collected by means of a mirror.   |
| Resolution                    | The minimum detectable angle an optical system can detect. Because of diffraction, there is a limit to the minimum angle, resolution. The larger the aperture, the better the resolution.   |
| Right Ascension: (RA)         | The angular distance of a celestial object measured in hours, minutes, and seconds along the Celestial Equator eastward from the Vernal Equinox.  |
| <b>S -</b><br>Sidereal Rate   | This is the angular speed at which the Earth is rotating. Telescope tracking motors drive the telescope at this rate. The rate is 15 arc seconds per second or 15 degrees per hour.   |

|                             |   |
|-----------------------------|---|
| <b>T -</b><br>Terminator    | The boundary line between the light and dark portion of the moon or a planet.   |
| <b>U -</b><br>Universe      | The totality of astronomical things, events, relations and energies capable of being described objectively.   |
| <b>V -</b><br>Variable Star | A star whose brightness varies over time due to either inherent properties of the star or something eclipsing or obscuring the brightness of the star.  |
| <b>W -</b><br>Waning Moon   | The period of the moon's cycle between full and new, when its illuminated portion is decreasing.  |
| Waxing Moon                 | The period of the moon's cycle between new and full, when its illuminated portion is increasing.  |
| <b>Z -</b><br>Zenith        | The point on the Celestial Sphere directly above the observer.  |
| Zodiac                      | The zodiac is the portion of the Celestial Sphere that lies within 8 degrees on either side of the Ecliptic. The apparent paths of the Sun, the Moon, and the planets, with the exception of some portions of the path of Pluto, lie within this band. Twelve divisions, or signs, each 30 degrees in width, comprise the zodiac. These signs coincided with the zodiacal constellations about 2,000 years ago. Because of the Precession of the Earth's axis, the Vernal Equinox has moved westward by about 30 degrees since that time; the signs have moved with it and thus no longer coincide with the constellations. |

# APPENDIX D – MAPS OF TIME ZONES

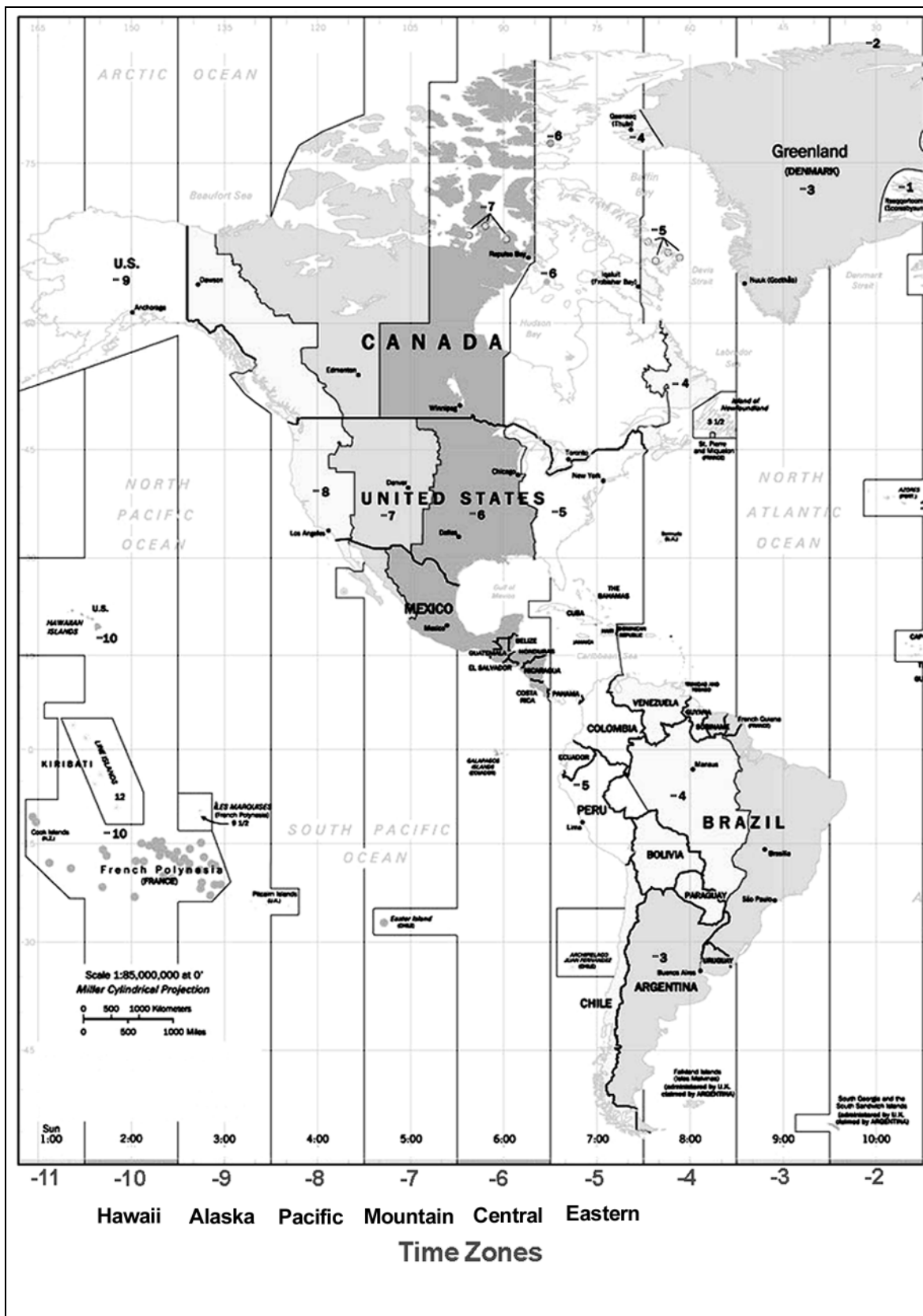

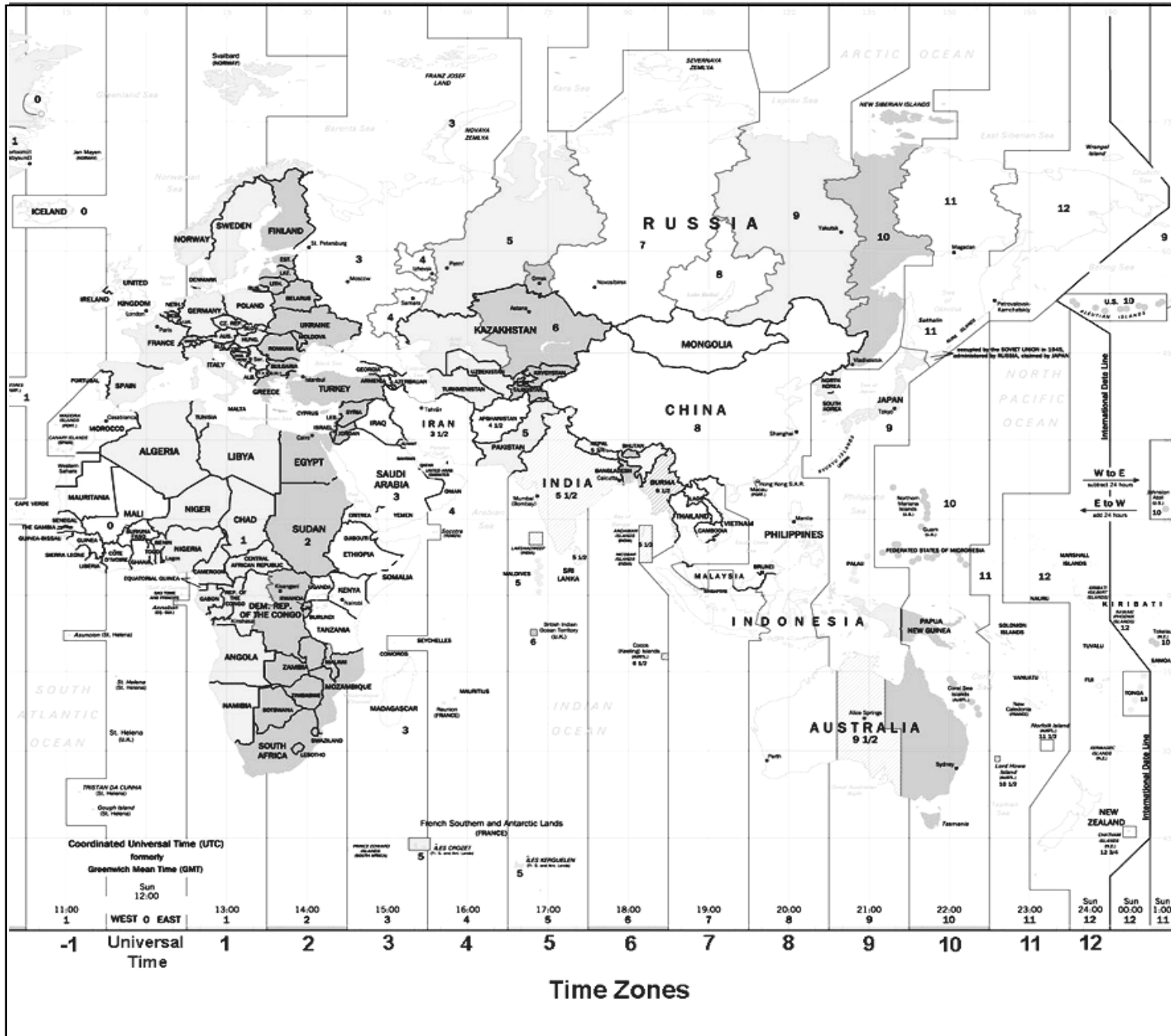

# January - February Sky

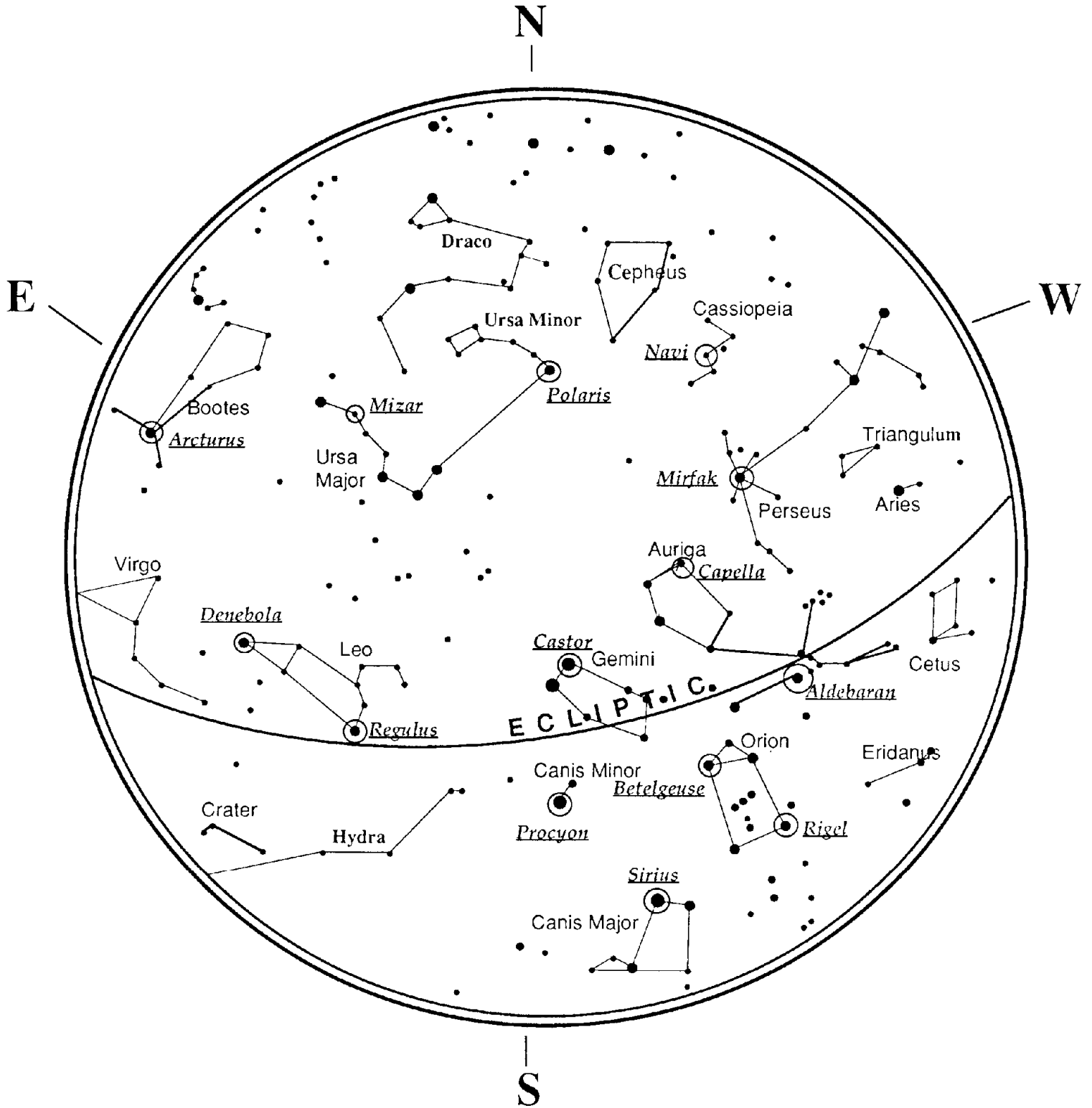





# July - August Sky

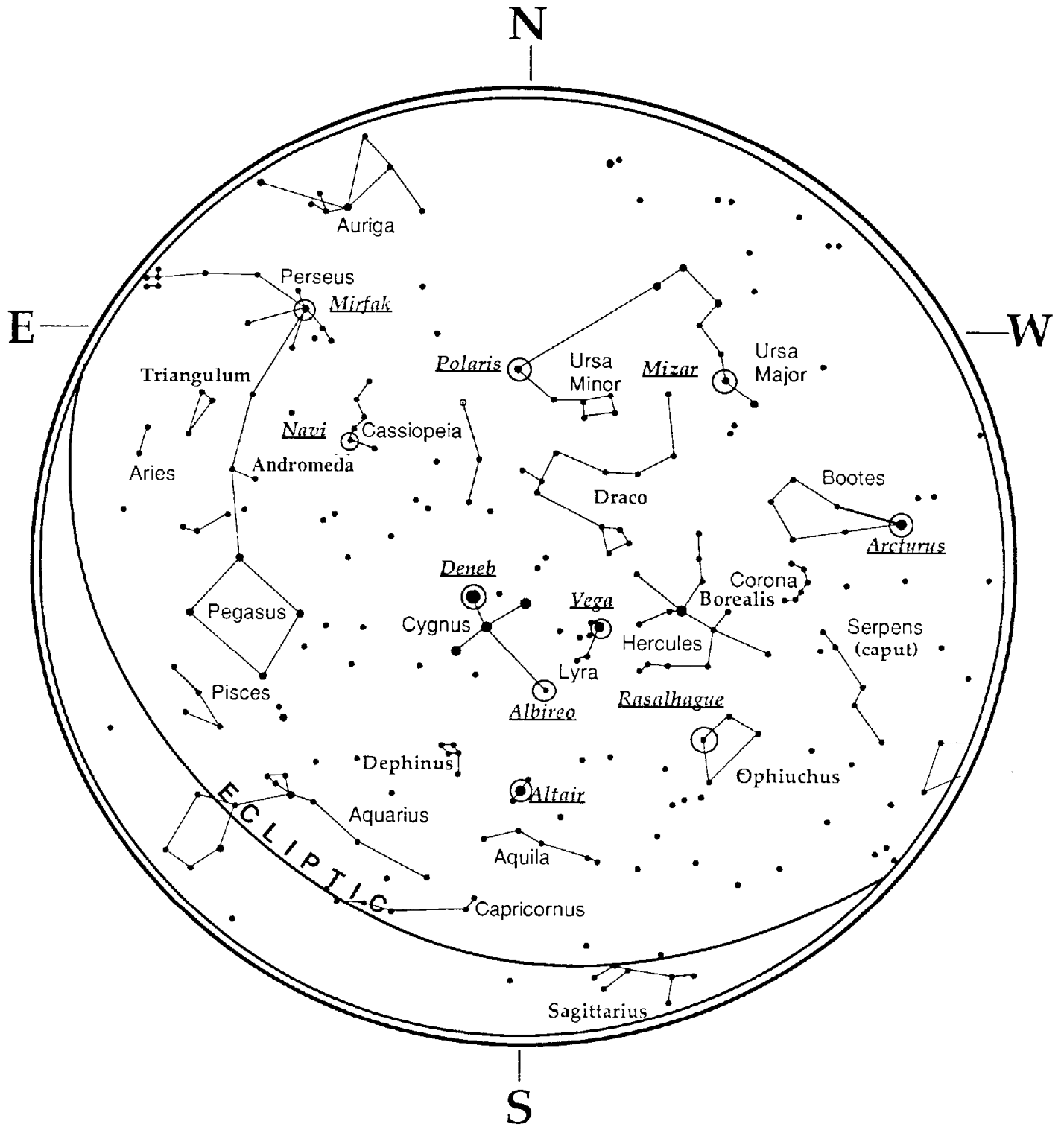

# September - October Sky

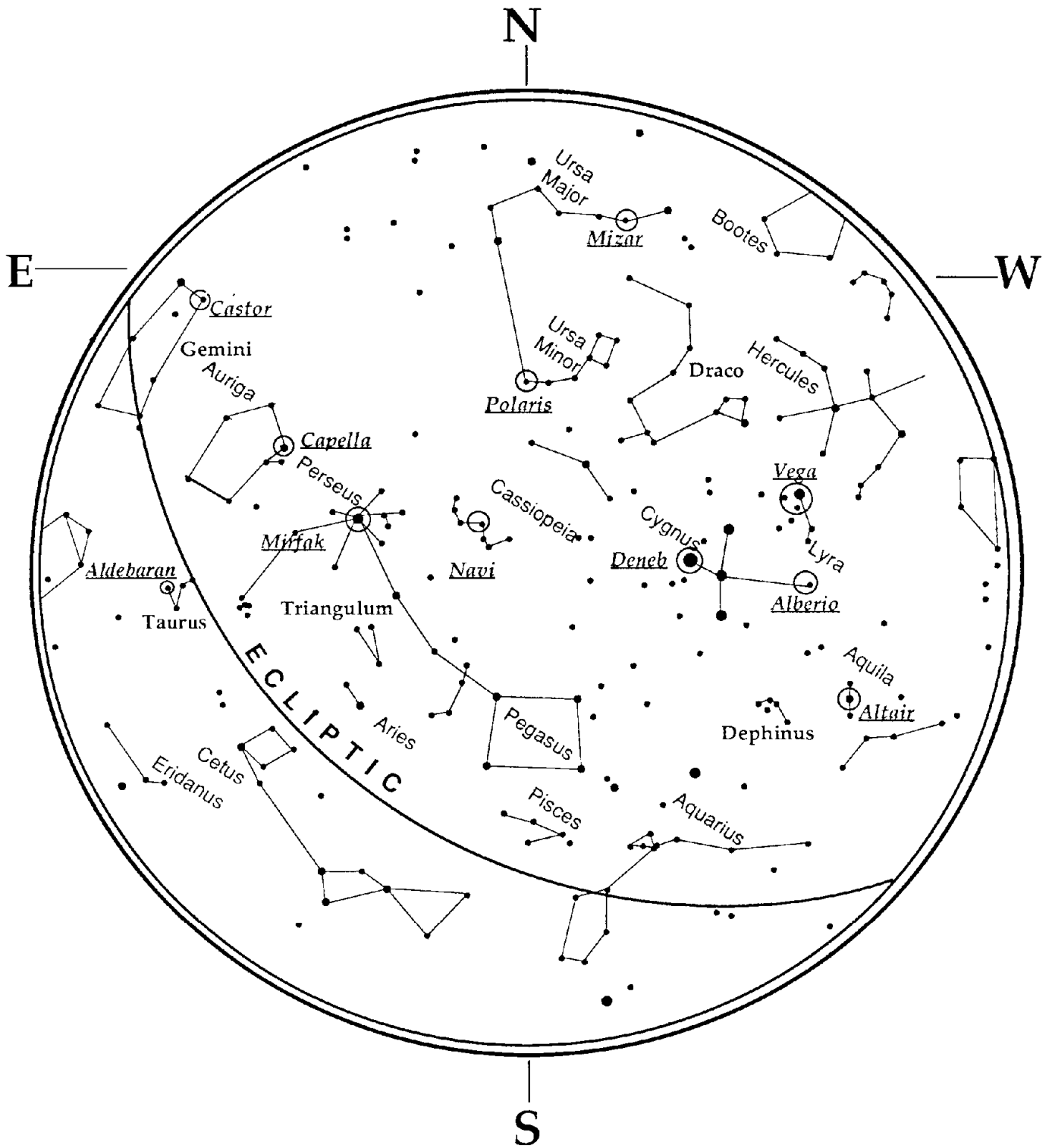

# November - December Sky

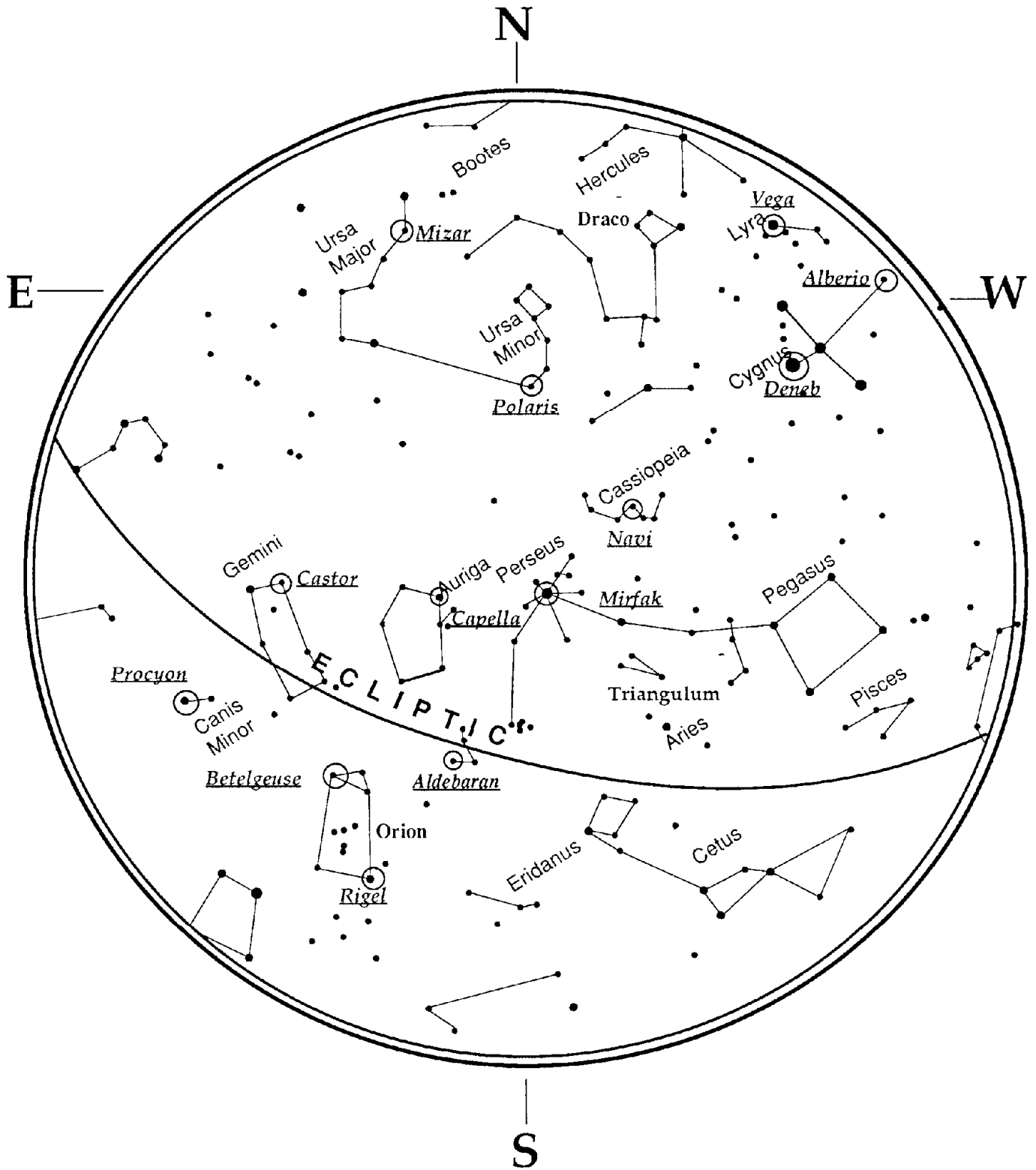



Celestron  
2835 Columbia Street  
Torrance, CA 90503  
Tel. (310) 328-9560  
Fax. (310) 212-5835  
Web site at <http://www.celestron.com>

Copyright 2010 Celestron  
All rights reserved.

(Products or instructions may change without notice or obligation.)

This device complies with Part 15 of the FCC Rule. Operation is subject to the following two conditions: 1) This device may not cause harmful interference, and 2) This device must accept any interference received, including interference that may cause undesired operations.

31150-INST  
09-09  
Printed in China  
\$10.00