

ASSEMBLY INSTRUCTIONS
COASTER FINE FURNITURE



Fine Furniture for every stage of life

193952NAT
Side Chair

ITEM : 193952NAT

ASSEMBLY INSTRUCTIONS



ASSEMBLY TIPS:

1. Remove hardware from box and sort by size.
2. Please check to see that all hardware and parts are present prior to start of assembly.
3. Please follow attached instructions in the same sequence as numbered to assure fast & easy assembly.



WARNING!







1. Don't attempt to repair or modify parts that are broken or defective. Please contact the store immediately.
2. This product is for home use only and not intended for commercial establishments.

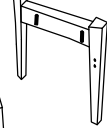
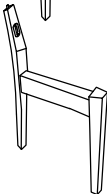

ASSEMBLY TIME

20 MINUTES

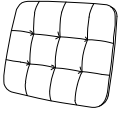
PARTS IDENTIFICATION

A	RIGHT LEG FRAME		1PC
B	LEFT LEG FRAME		1PC
C	FRONT RAIL (LONG)		1PC
D	BACK RAIL (SHORT)		1PC
E	FRONT LOWER RAIL (LONG)		1PC
F	BACKREST		1PC
G	BACK CUSHION (SMALL)		1PC
H	SEAT CUSHION (BIG)		1PC

NOTE :

Quantities shown are for one chair.

ITEM: 193952NAT

ASSEMBLY INSTRUCTIONS



ASSEMBLY TIPS:







1. Remove hardware from box and sort by size.
2. Please check to see that all hardware and parts are present prior to start of assembly.
3. Please follow attached instructions in the same sequence as numbered to assure fast & easy assembly.

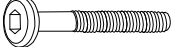

WARNING!

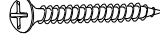
1. Don't attempt to repair or modify parts that are broken or defective. Please contact the store immediately.
2. This product is for home use only and not intended for commercial establishments.

HARDWARE IDENTIFICATION

1	ALLEN WRENCH (M4 x 100mm - BLK)		1PC
2	BOLT (M6 x 40mm - RBW)		4PCS
3	LOCK WASHER (1/4" - BLK)		4PCS
4	LONG PAN HEAD SCREW (#8 x 1 1/2" - BLK)		2PCS
5	MEDIUM PAN HEAD SCREW (#8 x 1 1/4" - BLK)		4PCS
6	SHORT PAN HEAD SCREW (#8 x 1" - BLK)		4PCS
7	CAM BOLT (263.20.847 - ZB)		2PCS
8	WOOD DOWEL (M8 x 30mm)		1PC

NOTE :

Phillips head screw driver is required in the assembly process ; However, manufacturer does not provide this item.
Quantities shown are for one chair.

ITEM: **193952NAT**



ASSEMBLY INSTRUCTIONS

STEP 1

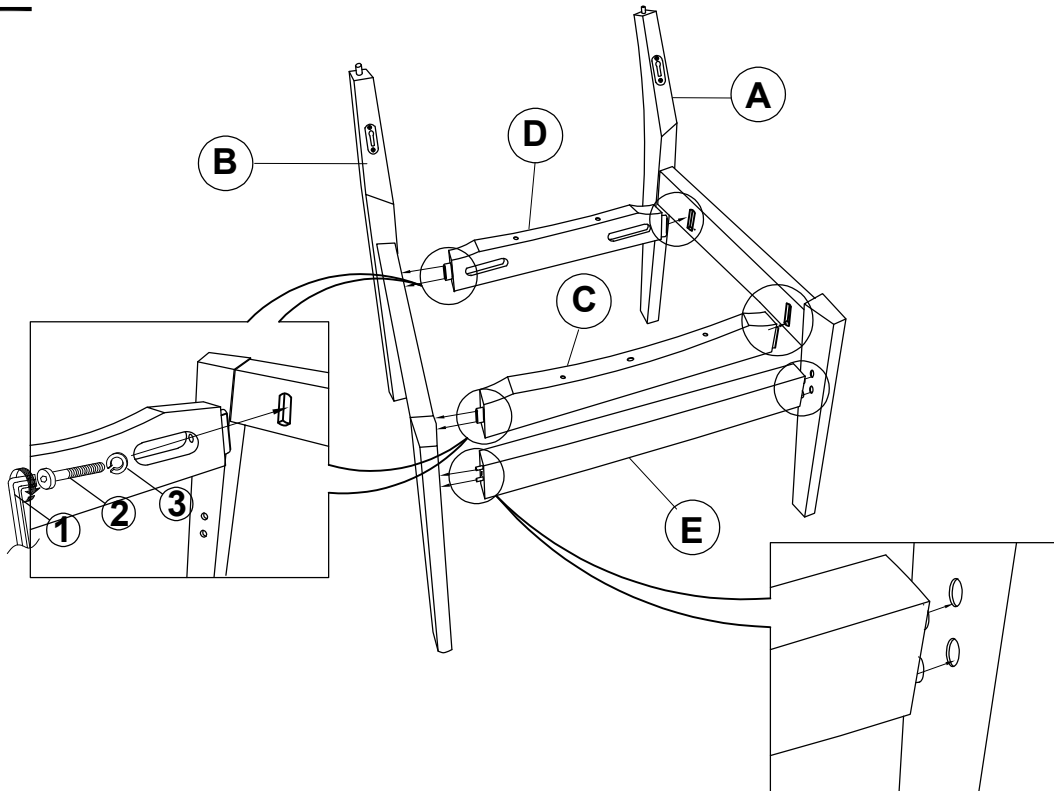

STEP 2

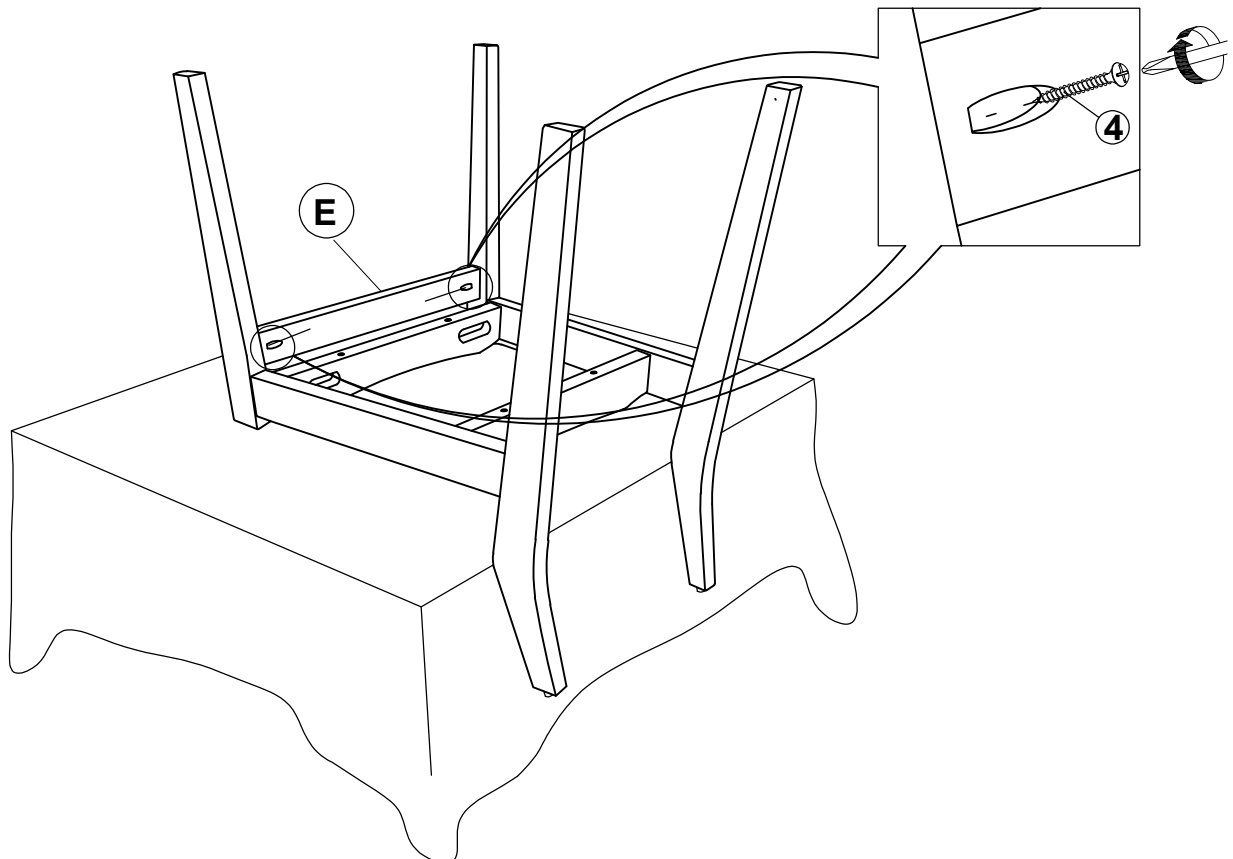

ITEM: 193952NAT



ASSEMBLY INSTRUCTIONS

STEP 3

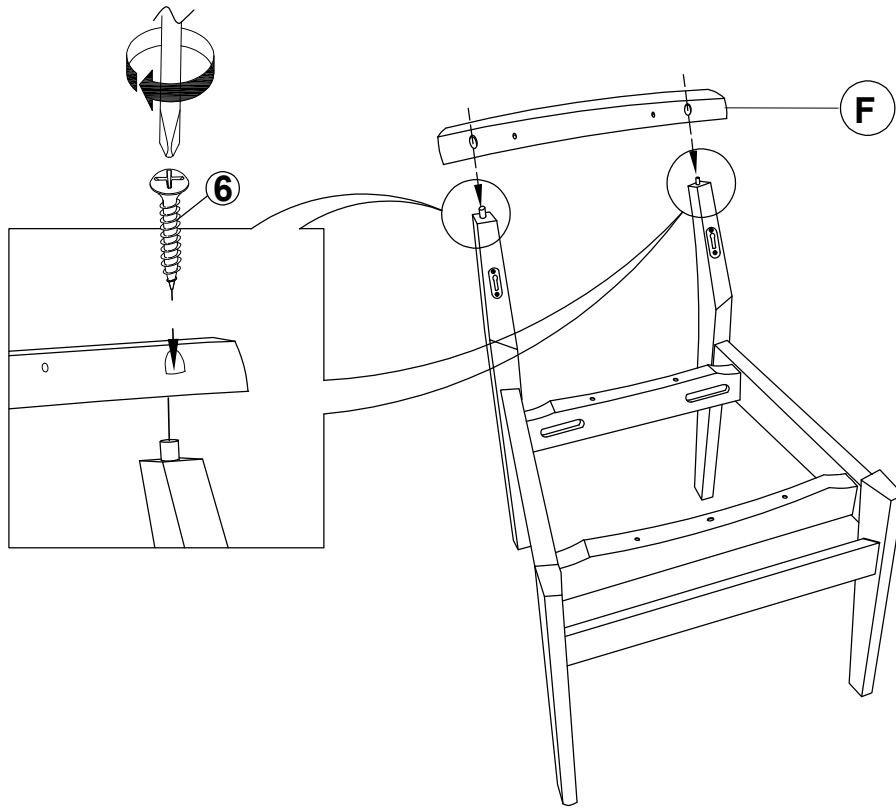

STEP 4

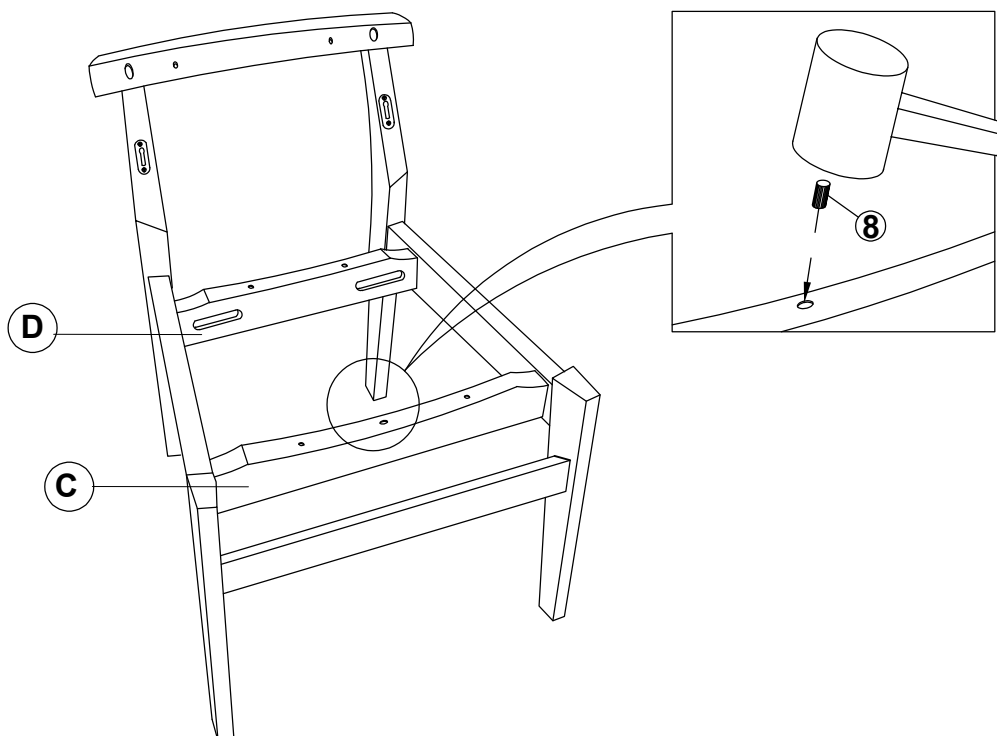

ITEM: 193952NAT



ASSEMBLY INSTRUCTIONS

STEP 5

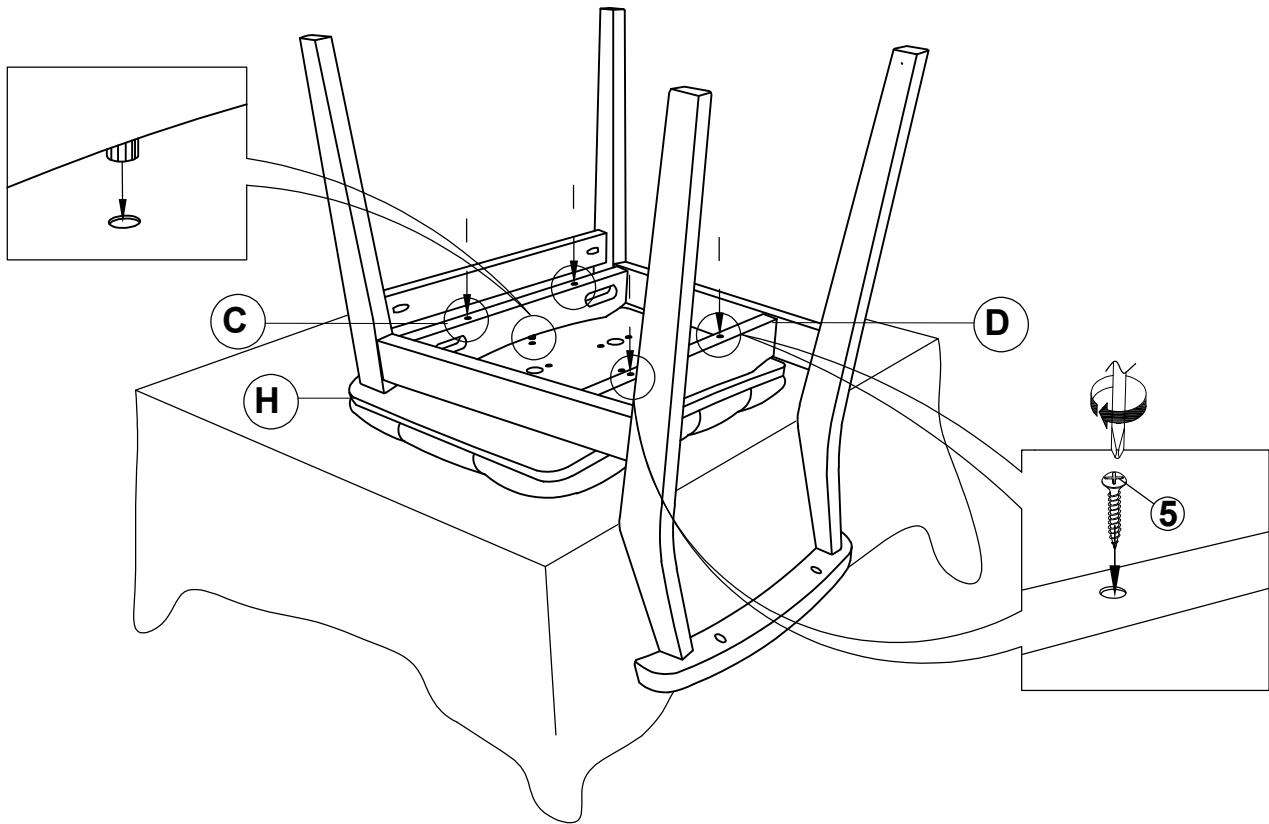

STEP 6

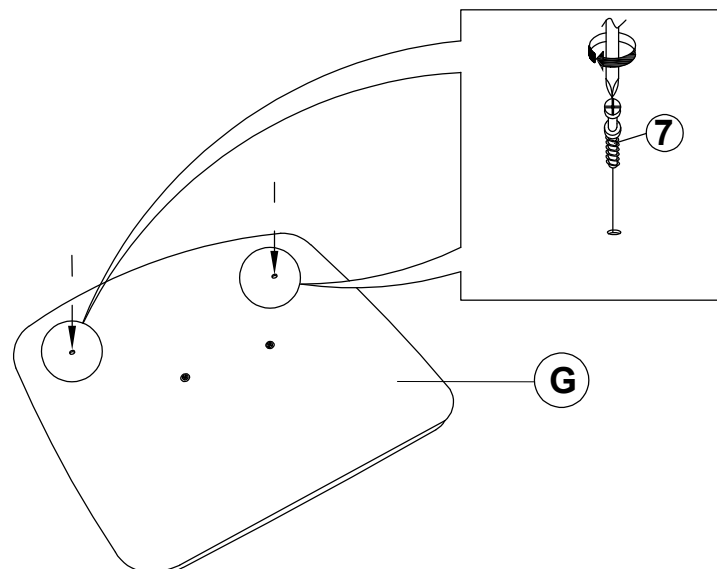

ITEM: 193952NAT



ASSEMBLY INSTRUCTIONS

STEP 7

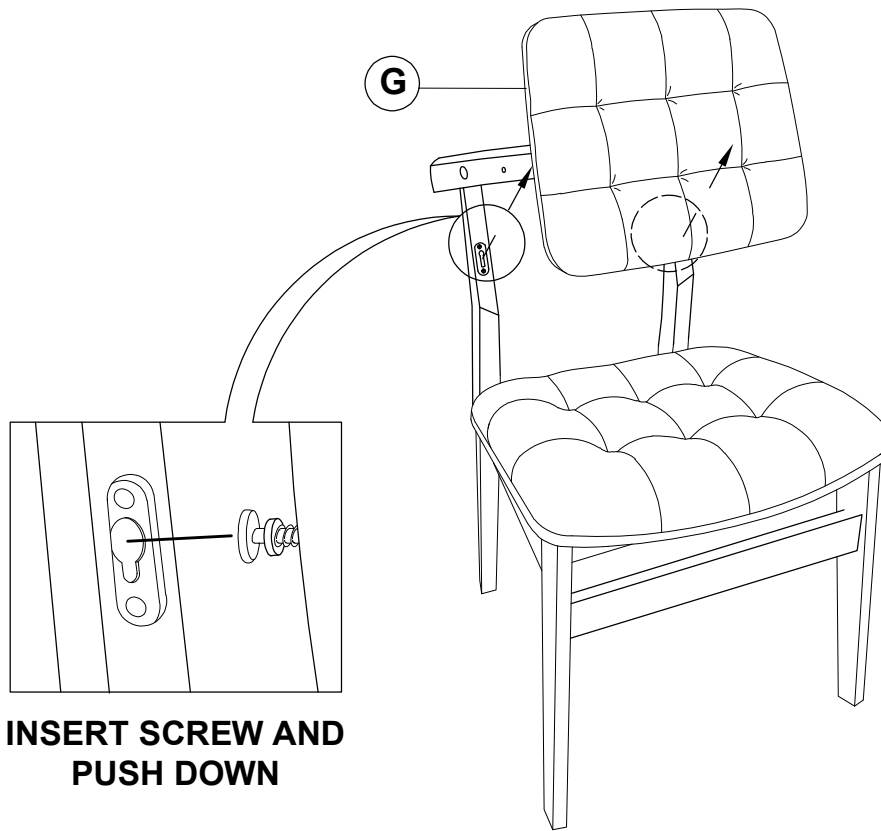

**INSERT SCREW AND
PUSH DOWN**

STEP 8

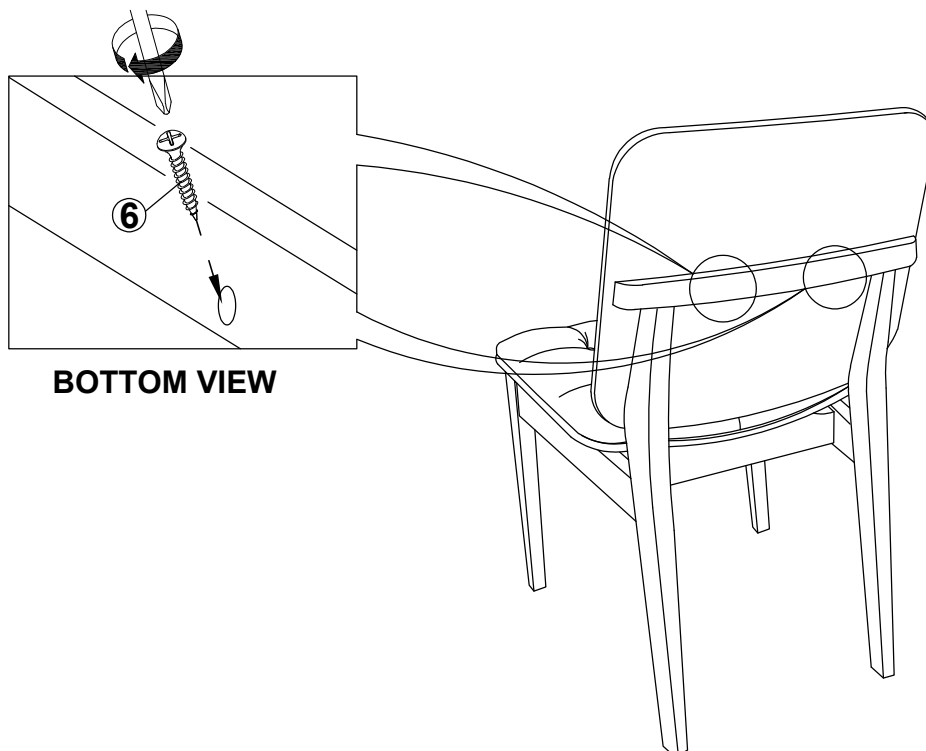

BOTTOM VIEW

ITEM: **193952NAT**

ASSEMBLY INSTRUCTIONS

STEP 9

COMPLETE

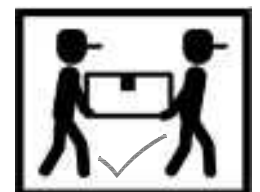
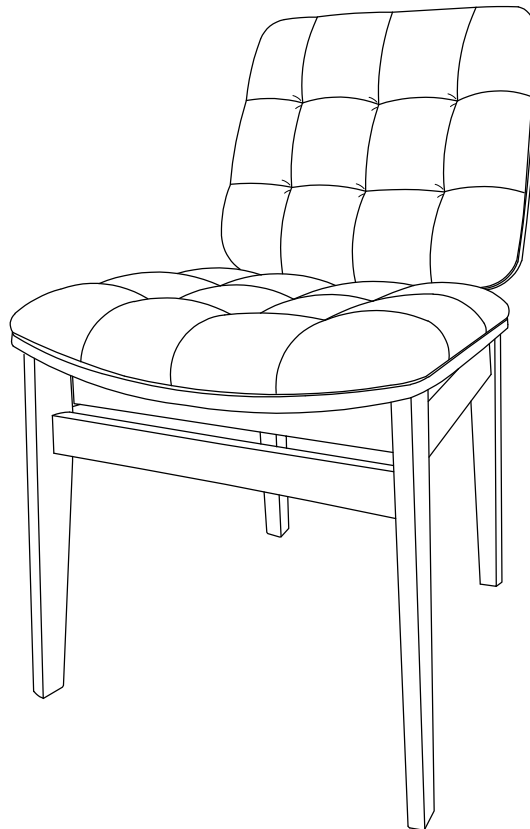

ITEM: **193952NAT**

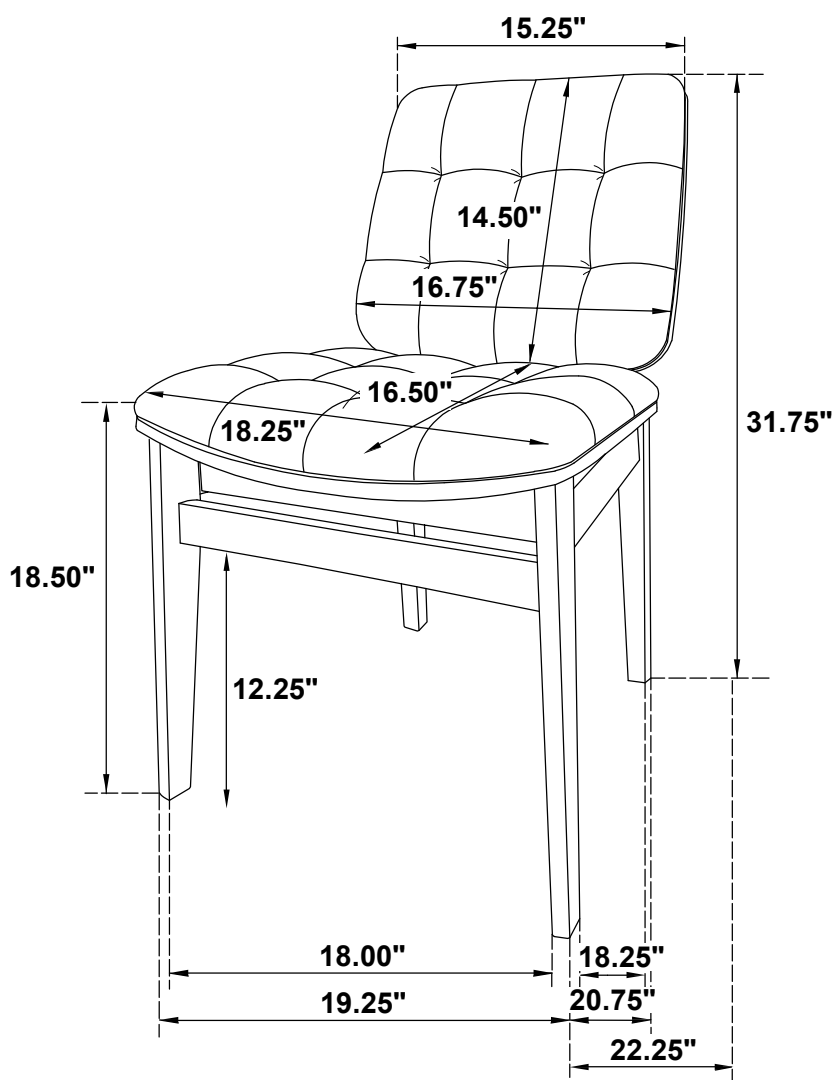

Note: Dimension tolerance $\pm 5\%$