



## Jump Starter 800A

Lithium-Ion Jump Starter & Power Bank  
With Fast Charge USB



### **FULLY CHARGE FIRST!**

For optimal performance, charge your Cobra Jump Starter prior to first use and every 12 months.

## **QUICK START GUIDE**

# Jump Starter 800A Features

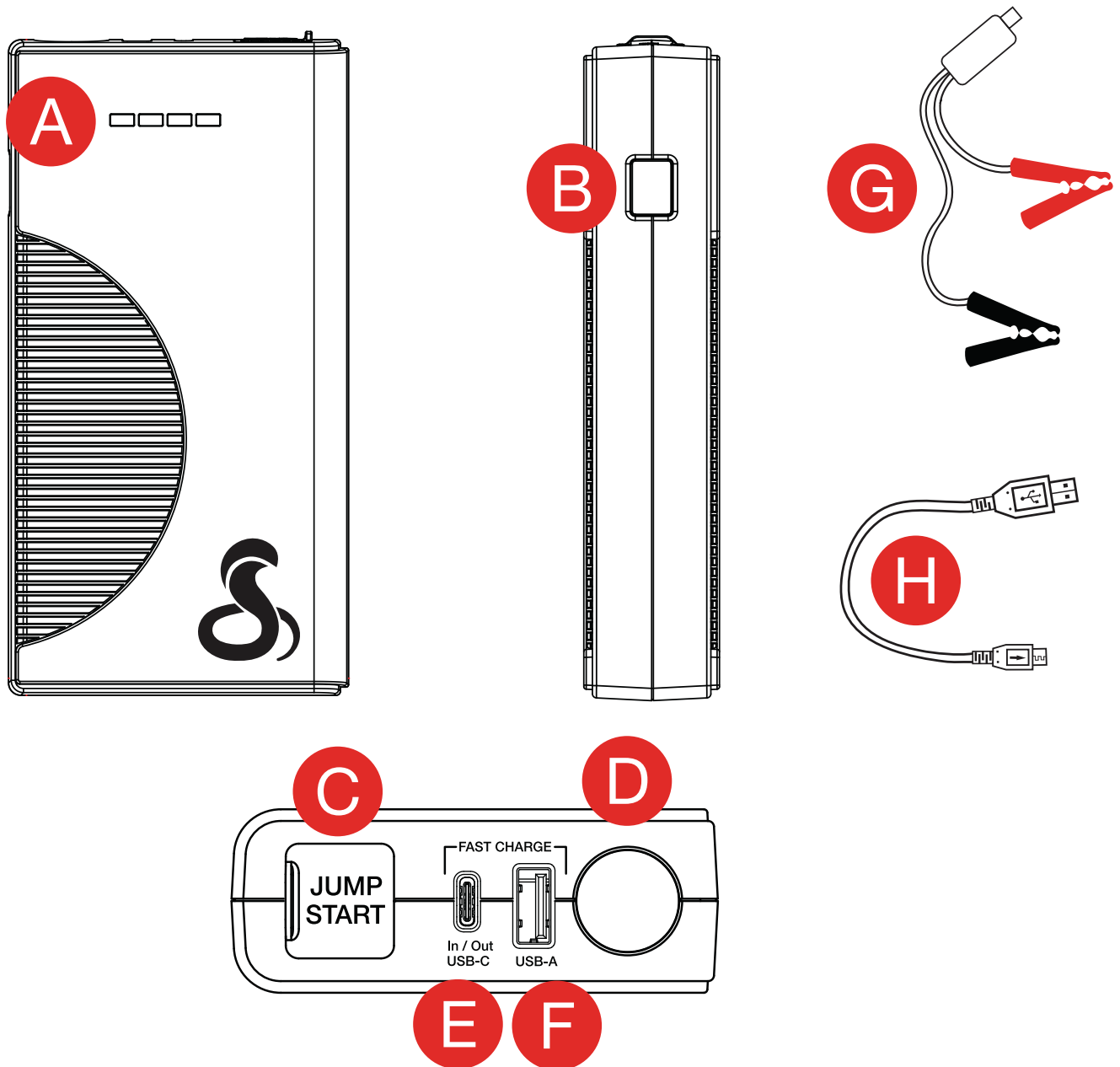

- A.** LED Battery Charge Bar
- B.** Power/Flashlight Button
- C.** Jump Start Connector
- D.** LED Flashlight

- E.** USB-C Fast Charge Input/Output
- F.** USB-A Fast Charge Output
- G.** Jump Start Cable
- H.** USB Cable

# Jump Starting Your Vehicle: **Direct-to-Battery**

- 1** Connect the jumper cable clamps to the battery terminals (First, **Red** to Positive, then **Black** to Negative)

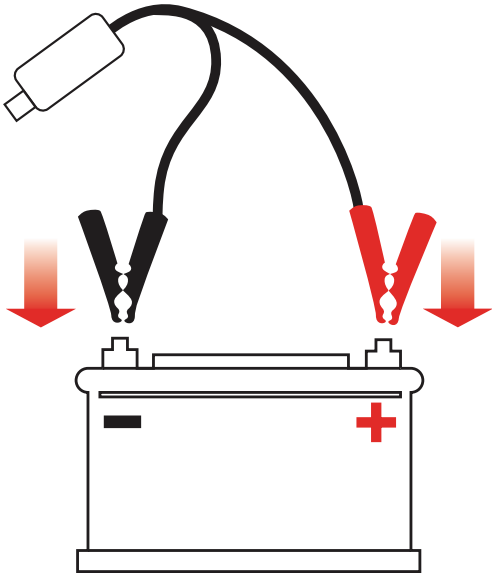

- 2** Connect the jumper cables to the Jump Starter 800A

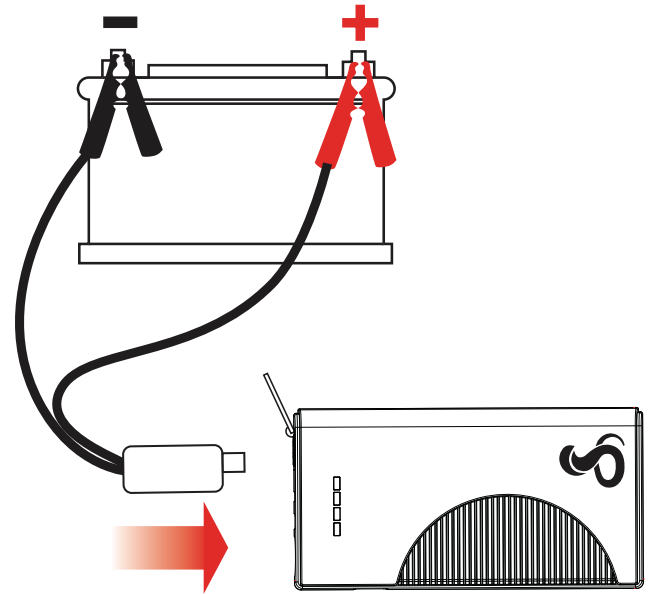

- 3** Wait for the Green LED light to appear on the Jump Start cable and then start your vehicle

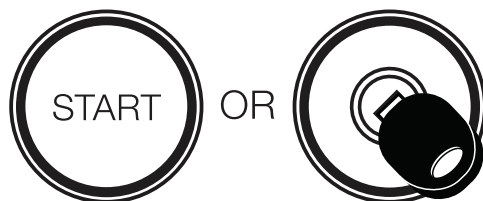
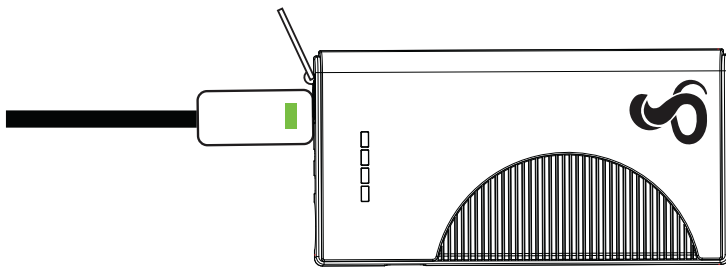

- 4** Disconnect the Jump Start cable from the Jump Starter 800A and then from the battery

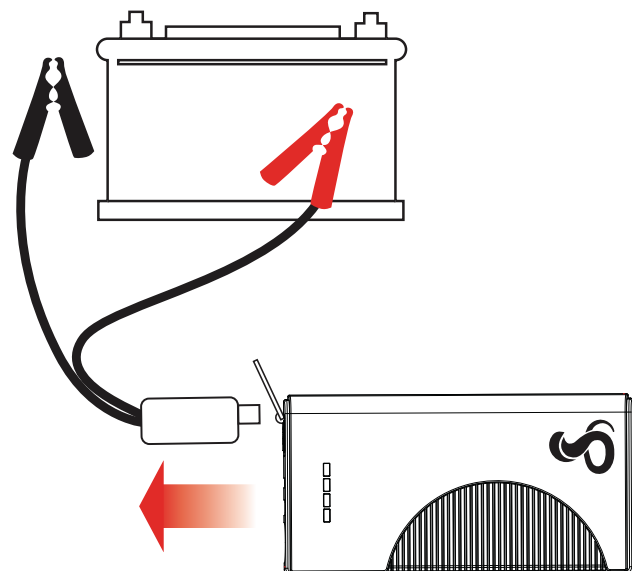

# Charging Your Devices

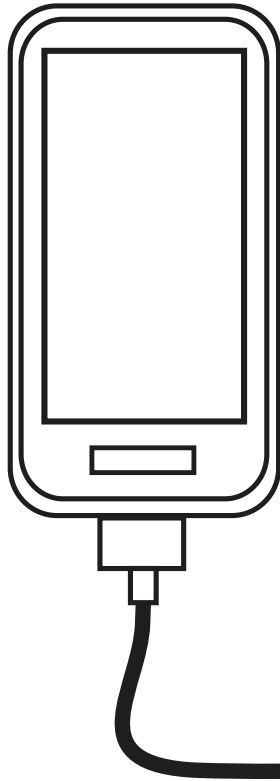

USB-A Charging

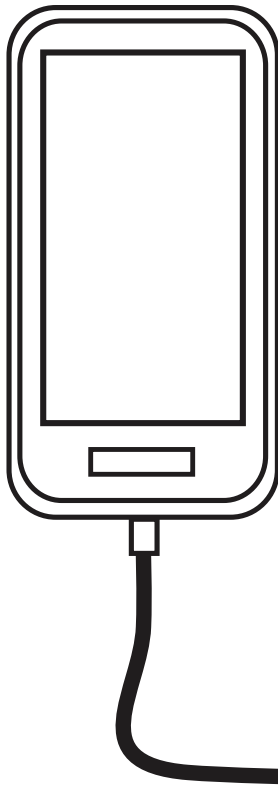
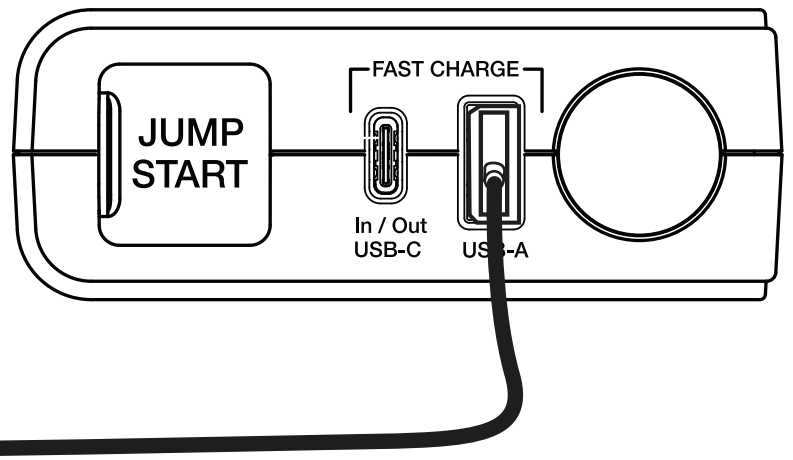

USB-C Charging

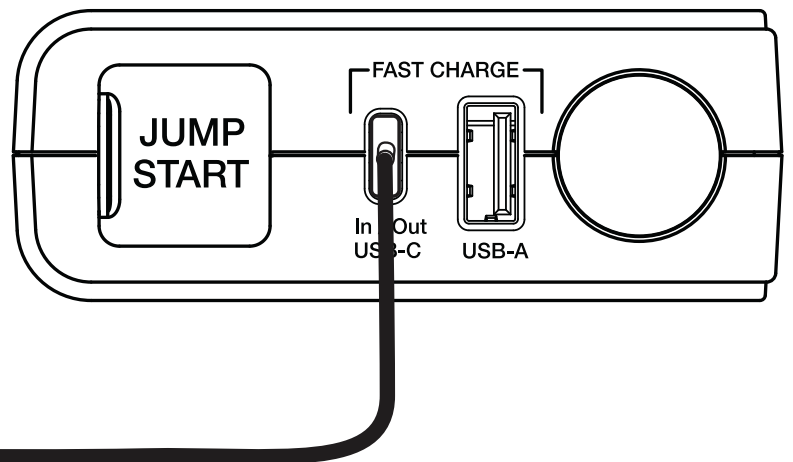

# Re-Charging Your Jump Starter 800A

## OPTION A

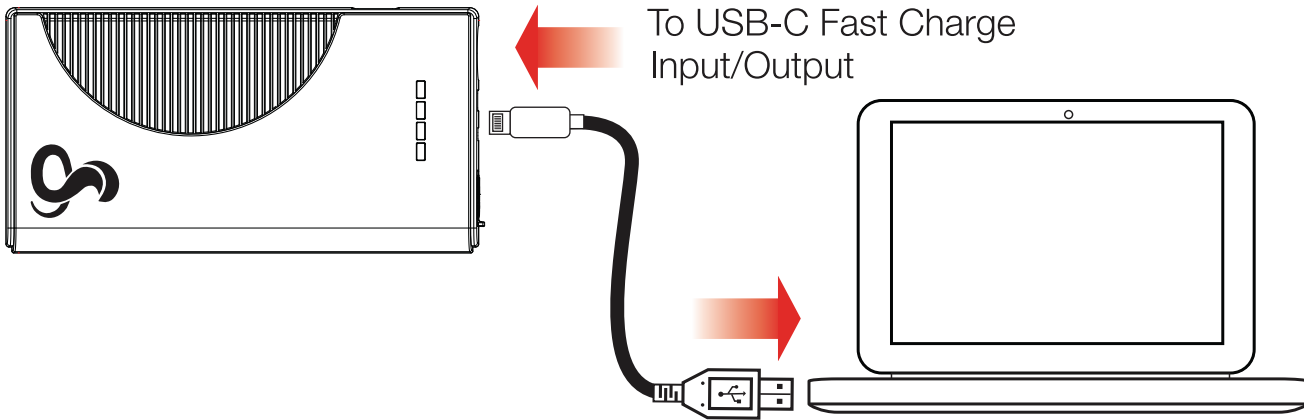

## OPTION B

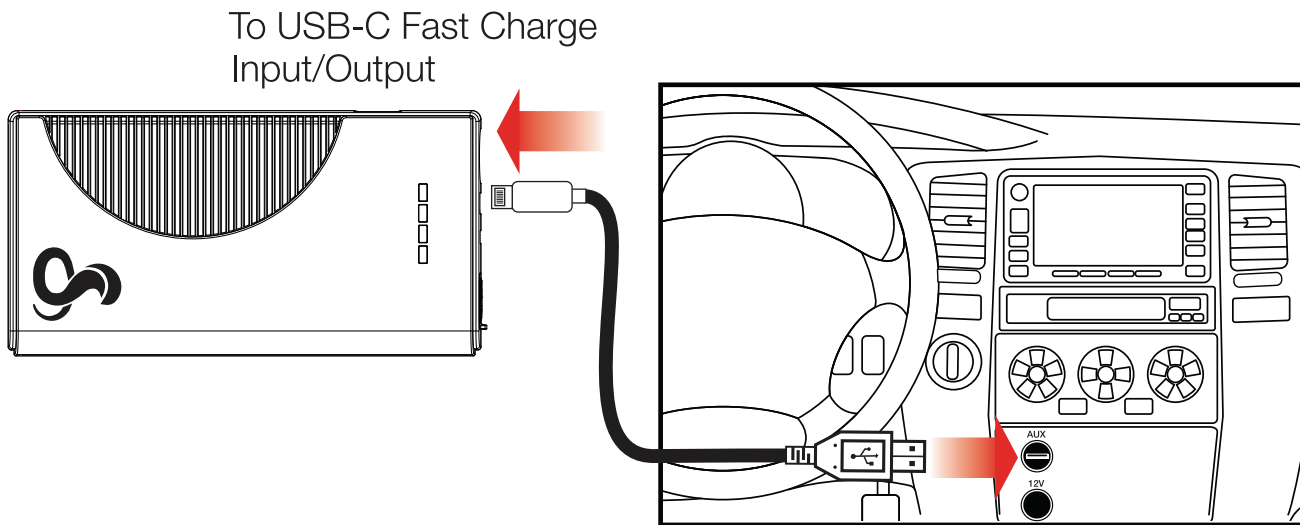

## OPTION C

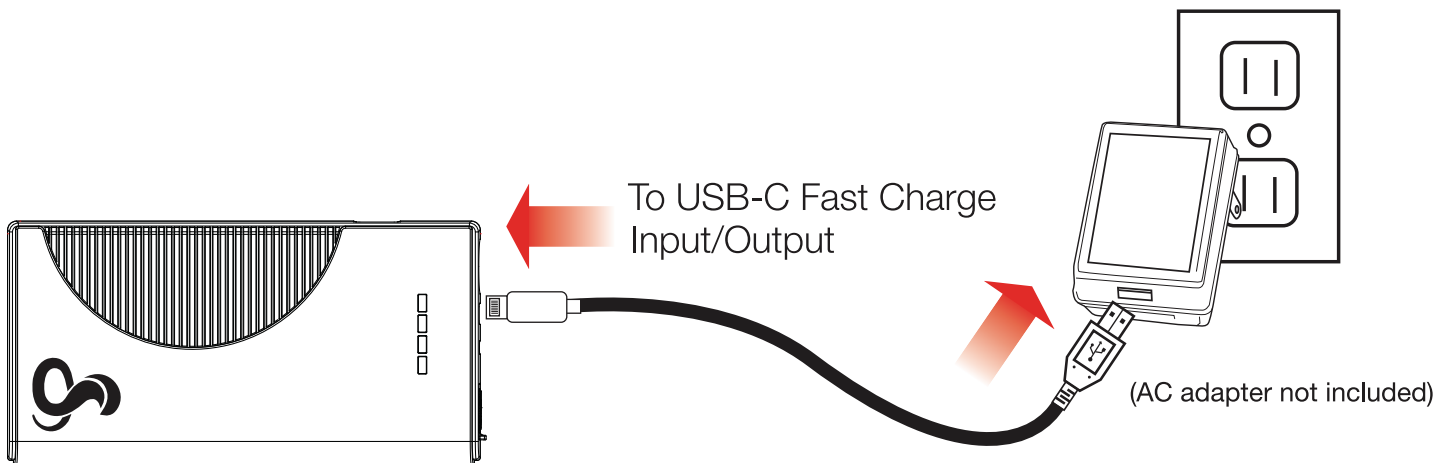

# Thank you for purchasing the **Cobra Jump Starter 800A**

Compact, yet powerful. The Jump Starter 800A serves as an excellent emergency jump starter that can start a dead battery for all passenger vehicles in less than a minute. It's Lithium-Ion battery and easy-to-carry design make it a convenient power bank to charge and power your devices. Keep this in your vehicle for when you or others will need it!

Count on Cobra for Power When You Need It.

Download the full Jump Starter 800A manual at: **[cobra.com/manuals](https://cobra.com/manuals)**



Cobra® and the snake design are registered trademarks of Cobra Electronics Corporation, USA.

Cobra Electronics Corporation™ is a trademark of Cobra Electronics Corporation, USA. Other trademarks and trade names are those of their respective owners.



# Jump Starter 800A

Owners Manual



## Compact 800A Jump Starter

### **FULLY CHARGE FIRST!**

For optimal performance, charge your Cobra Jump Starter prior to first use and every 12 months.

# Table of Contents

- Important Safety Information ..... 2**
- Jump Starter 800A Features ..... 4**
- Recharging Your Jump Starter 800A ..... 5**
- Jump Starting Your Vehicle ..... 6**
- Charging Your Devices ..... 7**
- LED Flashlight ..... 7**
- Specifications ..... 8**
- Frequently Asked Questions ..... 8**
- Limited 1-Year Warranty ..... 9**
- Product Service ..... 10**
- Ordering Info ..... 11**

## IMPORTANT SAFETY INSTRUCTIONS

### Precautions when working with the Jump Starter 800A:

 **WARNING:** Keep the unit clear of fire and water.

 **WARNING: Shock Hazard.** Keep away from children. Do not insert fingers or foreign objects into the Jump Start Cable Output or the USB Ports. Do not submerge this product in water, expose to rain, snow, condensation, or spray for long periods. Do not open the Jump Starter 800A. The battery is self-contained and there are no user replaceable parts inside the Jump Starter 800A. Do not use the Jump Starter 800A if it is damaged or modified. Damaged or modified batteries may exhibit unpredictable behavior resulting in fire, explosion, or risk of injury.

Do not operate the Jump Starter 800A or accessories with a damaged cord or plug. To reduce the risk of damage to cords pull from the connector rather than the cord when unplugging. Use of an accessory or an attachment not included with or recommended for the Jump Starter 800A may result in a risk of fire, electric shock, or injury.

 **WARNING: Explosion Hazard.** Do not use this product where there are flammable fumes or gases, such as an inadequately vented bilge of a boat or near propane tanks. Do not use this product in an enclosure containing automotive-type lead-acid batteries.

 **WARNING: Fire Hazard**  
Do not crush or puncture.

### **CAUTION: Operating temperature and environment**

Do not expose to temperatures over +113° F (+45° C) or under 14° F (-10° C). Using at high or low temperatures may reduce the internal battery capacity and shorten the battery life. Exposure to fire or temperatures over +265° F (+130° C) may cause explosion. Exercise care when using in wet conditions.

**Note:** In extreme cold weather conditions, please store indoors for best results.

Under abusive conditions, liquid may be ejected from the battery; avoid contact. Liquid ejected from the battery may cause irritation or burns.

**Note:** If contact accidentally occurs, flush with water. If liquid contacts eyes, additionally seek medical help.

 The Jump Starter 800A is supplied with a rechargeable Lithium-Ion battery. When charging the Jump Starter 800A work in a well ventilated area and do not restrict ventilation in any way. Proper charging practices will increase the life of the batteries. The unit and battery must be disposed of properly when it no longer holds a charge. For information on battery recycling call toll free 800-822-8837.

**CAUTION:** This device is not intended for use in a commercial repair facility.

## Precautions when working with vehicle batteries:



### **WARNING: Explosion and fire hazard**

1. Follow all instructions published by the battery manufacturer and the manufacturer of the equipment in which the battery is installed.
2. Make sure the area around the battery is well-ventilated.
3. Never smoke or allow a spark or flame in the vicinity of the engine or batteries.
4. Be careful not to drop a metal object on the battery or allow a metal tool to simultaneously touch the positive and negative cable ends or battery terminals.
5. Remove personal metal items such as rings, bracelets, necklaces, and watches when working with batteries. Batteries produce a short-circuit current high enough to weld a ring or other similar objects to metal, causing a severe burn.
6. If you need to remove a battery, always remove the negative terminal from the battery first. Make sure all accessories are off to prevent causing a spark.
7. Someone should be within range of your voice, or close enough to come to your aid when you work near batteries.
8. Have plenty of fresh water, soap and a supply of baking soda on hand in the area of the batteries in case of contact with battery acid. Baking soda neutralizes lead acid battery electrolyte.

**Note:** In extreme cold weather conditions, please store indoors for best results.

**Note:** When charging a device(s) the charge level may be lower than the actual battery charge level because the Jump Starter 800A cannot accurately measure the charge level during rapid charging. To confirm the actual battery charge level, disconnect the device(s) being charged and press the power button.

The Jump Starter 800A is designed for gasoline and diesel powered passenger cars and light duty trucks in good working order with batteries that are not damaged but require assistance commonly due to leaving lights on, cold temperature, sitting unused for limited periods of time.

The Jump Starter 800A uses a special high current battery to provide up to 800 peak amps to start your engine. It can provide 250 amps starting current to jump start multiple vehicles on one charge. After jumpstarting multiple vehicles, the unit should be recharged to full in order to keep the battery in healthy condition. The Jump Starter 800A will also go into recovery mode for 10 minutes after 4 attempted jumpstarts to prevent the battery from overheating.

The Jump Starter 800A is intended to jump start a vehicle with a battery that is not completely discharged.

# Jump Starter 800A Features

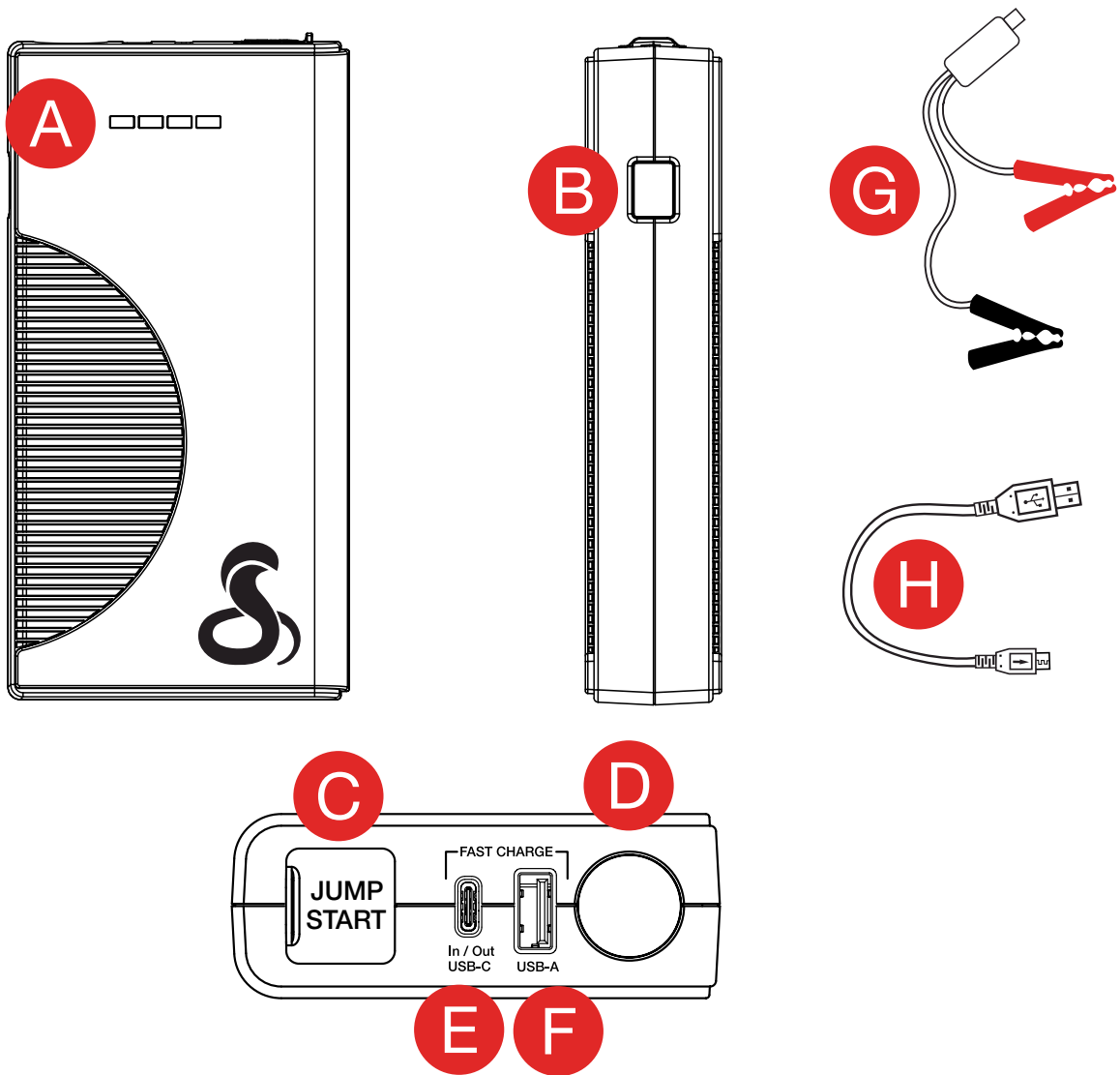

**A.** LED Battery Charge Bar

**B.** Power/Flashlight Button

**C.** Jump Start Connector

**D.** LED Flashlight

**E.** USB-C Fast Charge Input/Output

**F.** USB-A Fast Charge Output

**G.** Jump Start Cable

**H.** USB-C to A Cable

# Re-Charging Your Jump Starter 800A

The Jump Starter 800A is recharged through the USB-C input/output port on the Jump Starter with either the included charging cable or any compatible USB-C charging cable.

When the Jump Starter 800A is charging, LED battery charge bar will show the current battery charge level. The last section of the LED battery charge bar that is lit will blink to show that the Jump Starter 800A is charging. As the Jump Starter charges, more bars will illuminate solid until all bars are lit. The LED battery charge bar will turn off automatically once the Jump Starter is fully charged.

**For best battery performance the Jump Starter 800A should be fully recharged every 12 months or as needed based on your usage levels.**

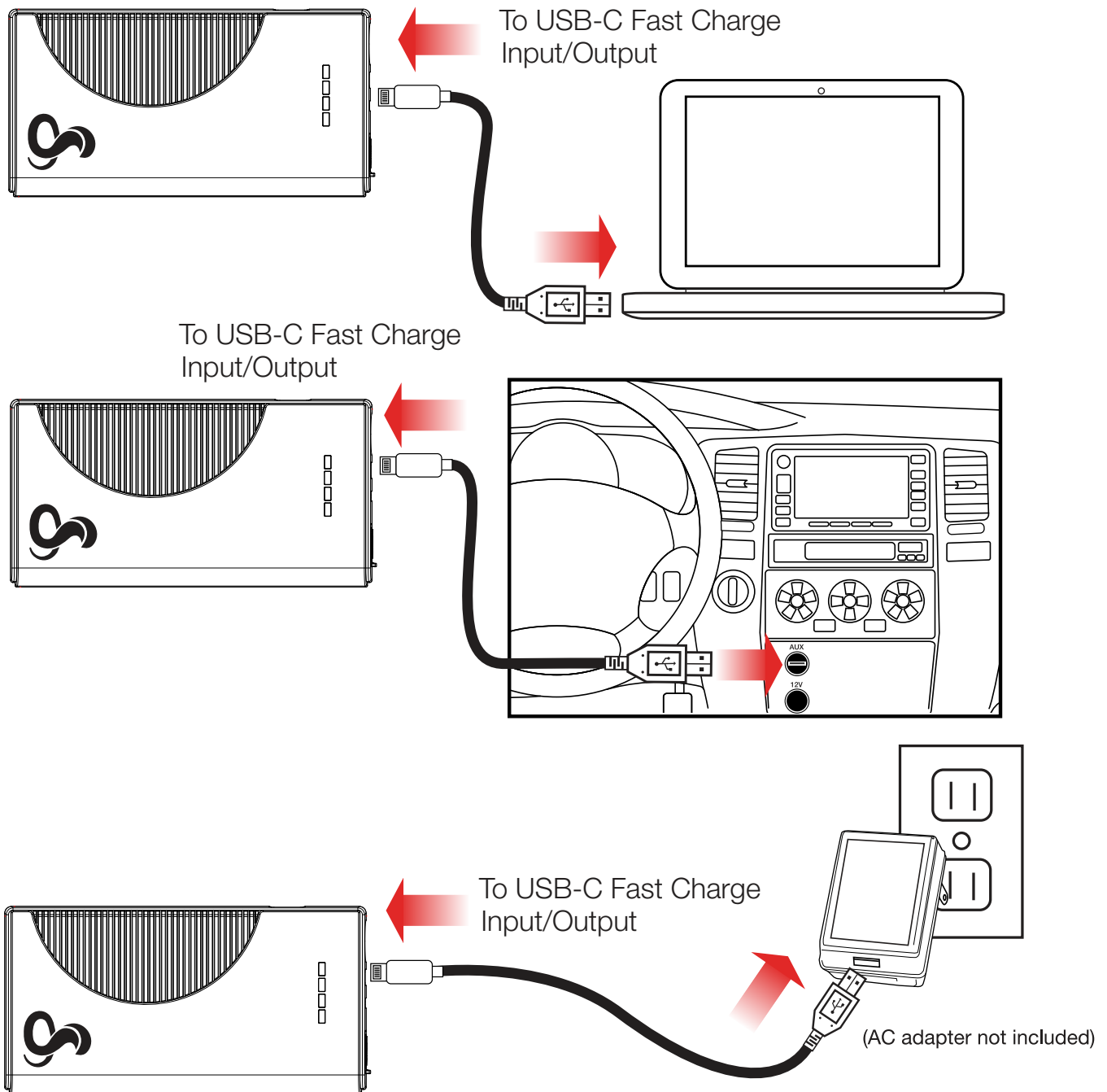

# Jump Starting Your Vehicle

**1** Connect the jump start cables to the battery terminals (First, **Red** to Positive, then **Black** to Negative)

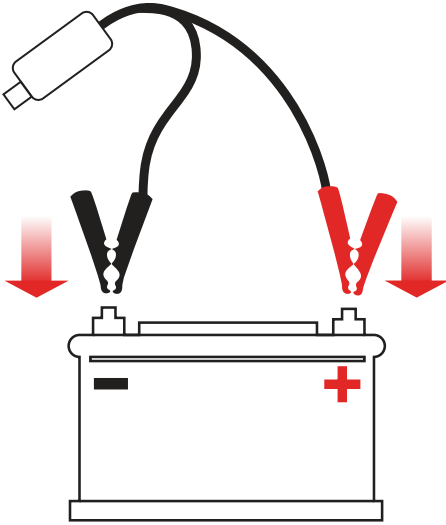

**2** Connect the jump start cables to the Jump Starter 800A

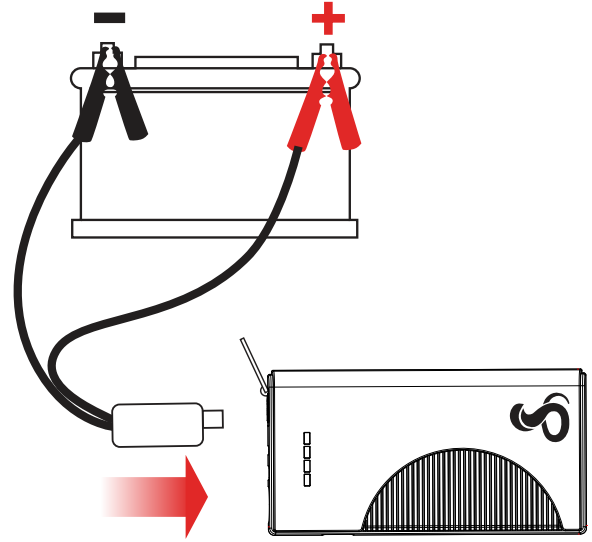

**3** Wait for the Green LED on the jump start cable and then start your vehicle

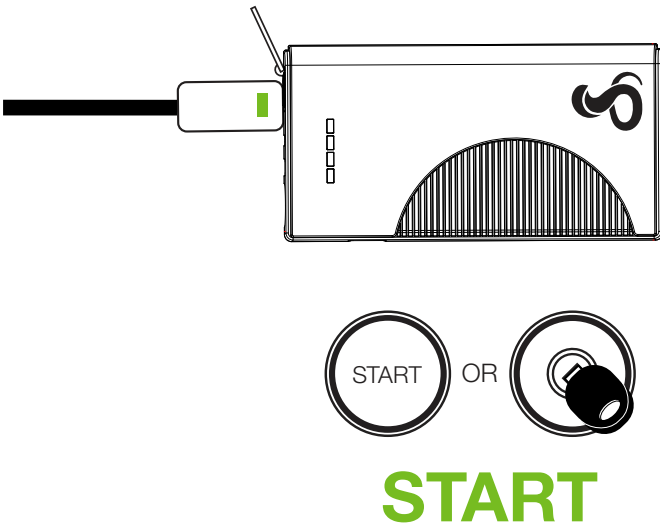

**4** Disconnect the jump start cable from the Jump Starter 800A and then from the battery

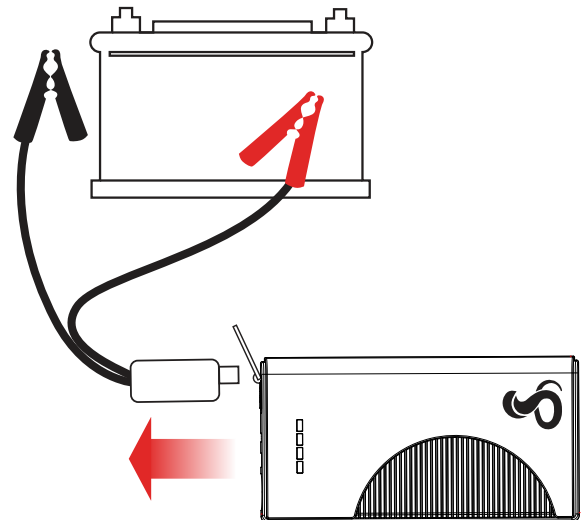

## Charging Your Devices

To charge a 5V USB device, connect the device's cable to either the Jump Starter 800A's USB-A or USB-C Outputs, depending on the type of device. Once your devices have been connected to the Jump Starter, press the power button to wake the Jump Starter from standby mode and begin charging.

Once charging has begun the LED battery charge bar on the Jump Starter 800A will illuminate to indicate that a device is being charged.

Once the device reaches its charge capacity and ceases charging, the charge bar will turn off.

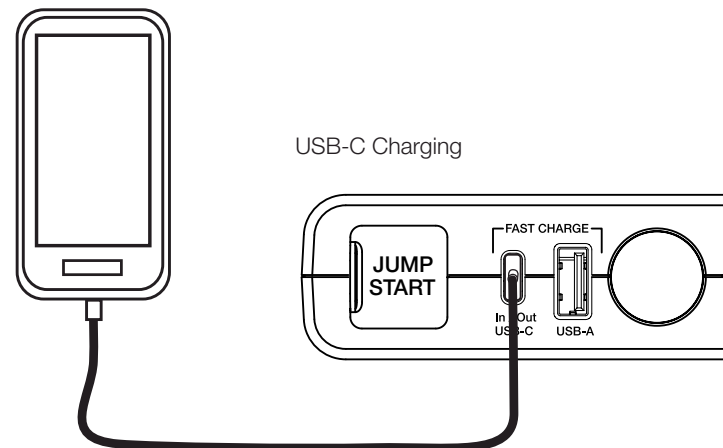
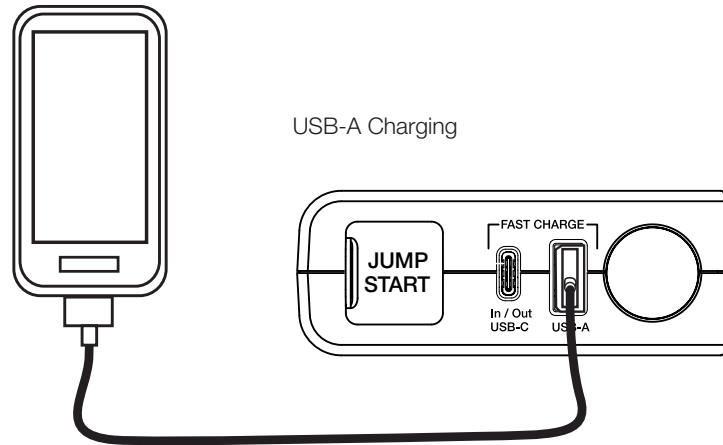

### LED Flashlight (ON/OFF):

1. Press and hold the Power/Flashlight button for 2 seconds to turn on the LED flashlight.
2. After the flashlight has been on for longer than 2 seconds, simply press the Power/Flashlight button to turn off the LED flashlight.

### LED Flashlight (Strobe and SOS):

1. Press and hold the Power/Flashlight button for 2 seconds to turn on the LED flashlight.
2. Quickly press the Power/Flashlight button within 2 seconds of the flashlight turning on to activate Strobe mode.
3. Quickly press the Power/Flashlight button again within 2 seconds of activating strobe mode to switch to SOS mode.
4. Press the Power/Flashlight button again to turn off the flashlight.

## Specifications

Battery:	Lithium-Ion 27.8 Wh (2.5Ah, 11.1V)
Size:	6.25" X 3.25" X 1.25" (LxWxH)
Weight:	.9lbs
Starting/Peak Current:	250 Amps/800 Amps
USB-A Output:	5V=3A / 9V=1.67A
USB-C Output:	5V=3A
Charge Input:	13.0 ~ 16.0VDC 1 Amp

## Frequently Asked Questions

### 1. Is my Jump Starter ready to go out of the box?

While your Jump Starter should have some level of charge, it is recommended that you charge your Jump Starter to full before using it to jumpstart any vehicle or putting it in long-term storage. After charging to full prior to first use, recharge your Jump Starter every 12 months or when it gets low after continued use.

### 2. Which port charges my Jump Starter?

While you can charge your devices using either the USB-C or USB-A port, you can only recharge your Jump Starter using the USB-C port.

### 3. Where do I look to see when my car is ready to jumpstart?

On the side of your jumper cables there will be a LED light to indicate the status of your current jumpstart. When the LED light shows solid green your car is ready to jumpstart. See the Tri-Color Status LED Table for additional LED light details.

### 4. What should I do if the LED light on my jumper cables does not turn on after connecting to my Jump Starter and car battery?

If your jumper cable LED light is not turning on after connecting to your Jump Starter and car battery, unplug your jumper cables for 30 seconds and check your Jump Starter's current battery charge before reconnecting the cables.

### 5. What should I do if my Jump Starter won't charge?

While Cobra's Jump Starters are designed to last an extended period of time without needing to be recharged, it is important to recharge your Jump Starter to full charge every 12 months or after regular use in order to keep your Jump Starter's battery healthy. If the Jump Starter is left in a low or no-charge state for an extended period of time it can cause irreparable damage to the battery and prevent the Jump Starter from being able to properly recharge.

## Tri-Color Status LED



The Status LED on the jump start cable will illuminate and the color will change if the following conditions are present:

<b>LED</b>	<b>CONDITION</b>
No LED	Connection not detected or the Jump Starter 1000A battery is depleted. Check the battery charge level and verify the connection of the jumper cable to the Jump Starter 1000A.
Solid Red	Reverse polarity connection. Reverse the clamps.
Flashing Red	Over-current protection. Wait for 30 seconds and then retry connection.
Solid Yellow	Solid contact established and charging for jump start.
Flashing Yellow	Either the cables are not properly connected or the Jump Starter 1000A is too hot. Remove cable and retry connection.
Red and Green Flashing Alternatingly	Safety feature to prevent the battery from overheating from too many jump start attempts in a short period of time. Remove cable and wait a few minutes.
Solid Green	Ready to jump start your vehicle.

## Limited 1-Year Warranty

### Warranty Terms:

Cobra warrants your product against all defects in materials and workmanship for a period of one (1) year from the date of original purchase.

Cobra, at our sole discretion, will repair or replace your product (with the same or comparable product) free of charge.

Cobra will not pay shipping charges that you incur for sending your product to us. Products received COD will be refused.

To make a warranty claim, we will require proof of purchase in the form of an invoice or receipt. No proof of purchase is required for factory direct purchases.

**Warranty Exclusions:** Warranty does not apply to your product under any of the following conditions: 1. The serial number has been removed or modified. 2. Your product has been subjected to misuse or damage (including water damage, physical abuse, and/or improper installation). 3. Your product has been modified in any way. 4. Your receipt or proof-of-purchase is from a non-authorized dealer or internet auction site including E-bay, U-bid, or other non-authorized resellers.

**LIMITATION OF WARRANTY: EXCEPT AS EXPRESSLY PROVIDED HEREIN, YOU ARE ACQUIRING THE PRODUCT “AS IS” AND “WHERE IS”, WITHOUT REPRESENTATION OR WARRANTY. COBRA SPECIFICALLY DISCLAIMS ANY REPRESENTATION OR WARRANTY INCLUDING, BUT NOT LIMITED TO THOSE CONCERNING THE MERCHANTABILITY AND SUITABILITY OF THE PRODUCT FOR A PARTICULAR PURPOSE. COBRA SHALL NOT BE LIABLE FOR CONSEQUENTIAL, SPECIAL OR INCIDENTAL DAMAGES INCLUDING, WITHOUT LIMITATION, DAMAGES ARISING OUT OF THE USE, MISUSE OR MOUNTING OF THE PRODUCT.**

The above limitations or exclusions shall be limited to the extent they violate the laws of any particular state. Cobra is not responsible for products lost in shipment between the owner and our service center.

### General Warranty Information

Each product we manufacture is covered by our factory warranty. While each product may have unique components and policy, the general guideline below will apply to most Cobra products.

All Cobra products purchased factory-direct or from our Authorized Resellers will come with a full one to three (1-3) year warranty from the date of the original retail purchase (see policy statement above for full warranty details and exclusions).

Standard accessories packaged with each model will have a one-year factory warranty.

Accessory items have a one-year factory warranty.

Shipping to our facility is not covered in our warranty. Return shipping is included within the US.

This warranty is non-transferrable.

For the sake of clarity, ‘repair or replace the Product or its defective part’ does not include removal or installation work, costs or expenses which include but are not limited to labor costs or expenses.

Cobra will not be responsible for lost packages.

## Product Service

If you have any questions about operation or installing your new Cobra product, PLEASE CONTACT COBRA FIRST...do not return this product to any retail store.

The contact information for Cobra will vary depending on the country in which you purchased and utilize the product. For the latest contact information, please go to [www.cobra.com/support](http://www.cobra.com/support)

For products purchased in the U.S.A. you may call 800-543-1608.

For products purchased in the U.S.A., if your product should require factory service, please please go to [www.cobra.com/support](http://www.cobra.com/support) and follow the instructions for returning your product to the Cobra Factory Service Department for service.

Should there be any problems with this product or further information is needed on its features please visit [www.cobra.com](http://www.cobra.com) for support, frequently asked questions, Declarations of Conformity, and full manuals.

### **For Products Purchased Outside the U.S.A. or Canada**

Please contact your local dealer for product service information.

### **For Products Used in Canada**

Industry Canada Notice

This device complies with Industry Canada license-exempt RSS standard(s). Operation is subject to the following two conditions:

- 1 this device may not cause interference, and
- 2 this device must accept any interference, including interference that may cause undesired operation of the device.

Le présent appareil est conforme aux CNR d'Industrie Canada applicables aux appareils radio exempts de licence. L'exploitation est autorisée aux deux conditions suivantes:

- 1 l'appareil ne doit pas produire de brouillage, et
- 2 l'utilisateur de l'appareil doit accepter tout brouillage radioélectrique subi, même si le brouillage est susceptible d'en compromettre le fonctionnement.

## Ordering Info

You can find quality Cobra products and accessories at your local Cobra dealer, or in the U.S.A., you can order directly from Cobra.

### **Please visit [www.cobra.com](http://www.cobra.com)**

Web orders will normally ship the next business day if received by us before 2:00 PM Eastern Time. Orders do not ship on weekends or holidays. All standard deliveries are Monday-Friday only. Saturday delivery can be requested in certain areas of the country for an additional shipping fee by calling Sales at **800-543-1608**.

Certain orders may require additional days to process prior to shipping. Holidays may also impact processing and shipping time frame. Occasionally, items may not ship due to inventory depletion. If you need your item to be expedited, **we recommend calling Sales at 800-543-1608**.

### **Order Acceptance**

Once your order has been accepted and processed, you will receive an email that will include the shipping carrier and tracking information.

### **Shipping and Delivery**

Free ground shipping is included to 48 states. Hawaii, Alaska and Puerto Rico ship based on assessed fee at checkout.

We require a physical address for shipping. Sorry, no P.O. Boxes or APO/FPO addresses. Please select 2-day or next day air for shipments to Hawaii or Alaska. Shipping charges are calculated on a per-product basis. Please make note of the shipping charges associated with each item.

\*\* For safety reasons, we cannot ship power packs/Jumpacks via air delivery methods. These items are available to ship via ground service only.

\*\*For your protection, some orders may require a signature for delivery.

Cobra® and the snake design are registered trademarks of Cobra Electronics Corporation, USA.

Cobra Electronics Corporation™ is a trademark of Cobra Electronics Corporation, USA.

Other trademarks and trade names are those of their respective owners.

## LITHIUM-ION JUMP STARTER & POWER BANK

With Fast Charge USB



### A LIFELINE FOR YOUR DEAD BATTERY

Get the backup power and peace of mind you need for your daily drives with a portable jump starter. Our Lithium-Ion jump starters give you the power to jump start your vehicle without any additional assistance. The Jump Starter 800A's compact size allows for easy storage within any vehicle while still being powerful enough to jump start multiple times on a single charge.



Holds Charge  
For 365+ Days



Jump Start  
All Cars



2 Fast Charge  
USB Ports



3-Mode  
LED Flashlight

## POWER WHEN YOU NEED IT

### Your Safety Is What Matters Most

Connect with confidence to any 12V battery with these built-in safeguards:

- Reverse Polarity Protection
- Short Circuit Protection
- Over-Charge Protection



800A MSRP: \$79.95



UL 2743 Standard

## SPECIFICATIONS

---

### UNIT DIMENSIONS:

6.25" L x 3.25" W x 1.25" D (160mm L x 83mm W x 31.5mm D)

### UNIT WEIGHT:

.9 lbs (408.2 g.)

### BATTERY:

Lithium-Ion - 27.75Wh

### STARTING CURRENT:

250A

### PEAK CURRENT:

800A

### USB-A OUTPUT:

Fast Charge up to 18 Watts

### USB-C INPUT/OUTPUT:

5V=2A, 9V=1.67A (In), 5V=3A (Out)

### INDIVIDUAL BOX DIMENSIONS:

7.6" H x 4.8"W x 3.54" D (193mm H x 122mm W x 90mm D)

### MODEL:

CPJS800A

### MASTER PACK QTY:

15

### MASTER PACK DIMENSIONS:

9.96" H x 14.96" W x 18.31" D (253mm H x 380mm W x 465mm D)

### MASTER PACK WEIGHT:

31.1 lbs (14.1 kg)

### UPC #:

028377 31585 5

### MASTER PACK BARCODE:

9 00 28377 31585 8

Specifications subject to change without notice.



# **Jump Starter**

Important Product Information

## IMPORTANT SAFETY INSTRUCTIONS

### Precautions when working with the Jump Starter:

 **WARNING:** Keep the unit clear of fire and water.

 **WARNING: Shock Hazard.** Keep away from children. Do not insert foreign objects into the Jump Start Cable Output, the USB Output Port, or any other product ports. Do not submerge this product in water, expose to rain, snow, condensation, or spray for long periods. Do not open the Jump Starter to replace the internal battery. There are no user replaceable parts inside the Jump Starter.

 **WARNING: Explosion Hazard.** Do not use this product where there are flammable fumes or gases, such as an inadequately vented bilge of a boat or near propane tanks. Do not use this product in an enclosure containing automotive-type lead-acid batteries.

 **WARNING: Fire Hazard**  
Do not crush or puncture.

 **Caution: Operating temperature**

Do not expose to temperatures over +113° F (+45° C) or under -14° F (-10° C). Using at high or low temperatures may reduce the internal battery capacity and shorten the battery life.

**Note:** In extreme cold weather conditions, please store indoors for best results.

 The Jump Starter is supplied with a rechargeable Li-Cobalt battery. This battery is self-contained and not consumer replaceable. The unit and battery must be disposed of properly when it no longer holds a charge. Proper charging practices will increase the life of the batteries. For information on battery recycling call toll free 800-822-8837.

## **Precautions when working with vehicle batteries:**

### **⚠ WARNING: Explosion and fire hazard**

1. Follow all instructions published by the battery manufacturer and the manufacturer of the equipment in which the battery is installed.
2. Make sure the area around the battery is well-ventilated.
3. Never smoke or allow a spark or flame in the vicinity of the engine or batteries.
4. Be careful not to drop a metal object on the battery or allow a metal tool to simultaneously touch the positive and negative cable ends or battery terminals.
5. Remove personal metal items such as rings, bracelets, necklaces, and watches when working with batteries. Batteries produce a short-circuit current high enough to weld a ring or other similar objects to metal, causing a severe burn.
6. If you need to remove a battery, always remove the negative terminal from the battery first. Make sure all accessories are off to prevent causing a spark.
7. Someone should be within range of your voice, or close enough to come to your aid when you work near batteries.
8. Have plenty of fresh water, soap and a supply of baking soda on hand in the area of the batteries in case of contact with battery acid. Baking soda neutralizes lead acid battery electrolyte.

## **FCC Statement:**

This device complies with part 15 of the FCC Rules. Operation is subject to the following two conditions: (1) This device may not cause harmful interference, and (2) this device must accept any interference received, including interference that may cause undesired operation.

**Note:** This equipment has been tested and found to comply with the limits for a Class B digital device, pursuant to Part 15 of the FCC Rules. These limits are designed to provide reasonable protection against harmful interference in a residential installation. This equipment generates uses and can radiate radio frequency energy and, if not installed and used in accordance with the instructions, may cause harmful interference to radio communications. However, there is no guarantee that interference will not occur in a particular installation.

If this equipment does cause harmful interference to radio or television reception, which can be determined by turning the equipment off and on, the user is encouraged to try to correct the interference by one or more of the following measures:

- Reorient or relocate the receiving antenna.
- Increase the separation between the equipment and receiver.
- Connect the equipment into an outlet on a circuit different from that to which the receiver is connected.
- Consult the dealer or an experienced radio/television technician for help.

**WARNING:** Any modifications made to this device that are not expressly approved by party responsible for compliance could void the user's authority to operate this device.

## **For Products Used in Canada**

### **Industry Canada Notice**

This device complies with Industry Canada license-exempt RSS standard(s). Operation is subject to the following two conditions:

(1) this device may not cause interference, and (2) this device must accept any interference, including interference that may cause undesired operation of the device.

Le présent appareil est conforme aux CNR d'Industrie Canada applicables aux appareils radio exempts de licence. L'exploitation est autorisée aux deux conditions suivantes:

(1) l'appareil ne doit pas produire de brouillage, et (2) l'utilisateur de l'appareil doit accepter tout brouillage radioélectrique subi, même si le brouillage est susceptible d'en compromettre le fonctionnement.

## **Warranty Terms:**

Cobra warrants your product against all defects in materials and workmanship for a period of one (1) year from the date of original purchase. Cobra, at our sole discretion, will repair or replace your product (with the same or comparable product) free of charge.

Cobra will not pay shipping charges that you incur for sending your product to us. Products received COD will be refused.

To make a warranty claim, we will require proof of purchase in the form of an invoice or receipt.

No proof of purchase is required for factory direct purchases.

**Warranty Exclusions:** Warranty does not apply to your product under any of the following conditions: 1. The serial number has been removed or modified. 2. Your product has been subjected to misuse or damage (including water damage, physical abuse, and/or improper installation). 3. Your product has been modified in any way. 4. Your receipt or proof-of-purchase is from a non-authorized dealer or internet auction site including E-bay, U-bid, or other nonauthorized resellers.

LIMITATION OF WARRANTY: EXCEPT AS EXPRESSLY PROVIDED HEREIN, YOU ARE ACQUIRING THE PRODUCT "AS IS" AND "WHERE IS", WITHOUT REPRESENTATION OR WARRANTY. COBRA SPECIFICALLY DISCLAIMS ANY REPRESENTATION OR WARRANTY INCLUDING, BUT NOT LIMITED TO THOSE CONCERNING THE MERCHANTABILITY AND SUITABILITY OF THE PRODUCT FOR A PARTICULAR PURPOSE. COBRA SHALL NOT BE LIABLE FOR CONSEQUENTIAL, SPECIAL OR INCIDENTAL DAMAGES INCLUDING, WITHOUT LIMITATION, DAMAGES ARISING OUT OF THE USE, MISUSE OR MOUNTING OF THE PRODUCT.

The above limitations or exclusions shall be limited to the extent they violate the laws of any particular state. Cobra is not responsible for products lost in shipment between the owner and our service center.

## **General Warranty Information**

Each product we manufacture is covered by our factory warranty. While each product may have unique components and policy, the general guideline below will apply to most Cobra products.

All Cobra products purchased factory-direct or from our Authorized Resellers will come with a full one to three (1-3) year warranty from the date of the original retail purchase (see policy statement above for full warranty details and exclusions).

Standard accessories packaged with each model will have a one-year factory warranty.

Accessory items have a one-year factory warranty.

Shipping to our facility is not covered in our warranty. Return shipping is included within the US.

This warranty is non-transferrable.

For the sake of clarity, 'repair or replace the Product or its defective part' does not include removal or installation work, costs or expenses which include but are not limited to labor costs or expenses.

Cobra will not be responsible for lost packages.

## Product Service

If you have any questions about operation or installing your new Cobra product, PLEASE CONTACT COBRA FIRST...do not return this product to any retail store.

The contact information for Cobra will vary depending on the country in which you purchased and utilize the product. For the latest contact information, please go to [www.cobra.com/support](http://www.cobra.com/support)

For products purchased in the U.S.A. you may call 800-543-1608.

For products purchased in the U.S.A., if your product should require factory service, please please go to [www.cobra.com/support](http://www.cobra.com/support) and follow the instructions for returning your product to the Cobra Factory Service Department for service.

Should there be any problems with this product or further information is needed on its features please visit [www.cobra.com](http://www.cobra.com) for support, frequently asked questions, Declarations of Conformity, and full manuals.

## For Products Purchased Outside the U.S.A. or Canada

Please contact your local dealer for product service information.

## Disposal of Old Electrical or Electronic Equipment

This product may contain hazardous substances that impact health and the environment if not disposed of properly.



The crossed out wheeled bin symbol indicates that the product should not be disposed along with household waste. It should handed over to an applicable collection point for the recycling of electrical equipment. By ensuring that this product is disposed of correctly you will help/prevent potential negative impact on the environment.

If you need more information on the collection, reuse and recycling systems, please contact your local civic office or the shop where it was originally purchased.

Cobra® and the snake design are registered trademarks of Cobra Electronics Corporation, USA.

Cobra Electronics Corporation™ is a trademark of Cobra Electronics Corporation, USA.



# Register your new Cobra product

[www.cobra.com/register](http://www.cobra.com/register)

Register your product today to get:



Helpful  
Product Tips



Exclusive  
Offers



Expert  
Advice

 **Cobra**<sup>®</sup>