

ECL Comfort 100M User's Guide and Installation



2004.05



ECL Comfort 100M User's Guide and Installation



2004.05



Table of contents

	Page No.
User's Guide	
Before you start	3
Operating the controller	4
Setting the clock	5
Individual comfort and reduced comfort periods	5
Controller mode	6
Temperature setting	8
Temperature reduction	10
Setting the heat curve	12
Controller settings on the rear side	14
Installation and maintenance	
Before you start	19
Identifying the system type	20
Mounting the controller	22
Placing the temperature sensor types	24
Electrical connections	26
LED indication	29
Check list	30
Communication	32
Power back-up	34
Definitions	36

Table of contents

	Page No.
User's Guide	
Before you start	3
Operating the controller	4
Setting the clock	5
Individual comfort and reduced comfort periods	5
Controller mode	6
Temperature setting	8
Temperature reduction	10
Setting the heat curve	12
Controller settings on the rear side	14
Installation and maintenance	
Before you start	19
Identifying the system type	20
Mounting the controller	22
Placing the temperature sensor types	24
Electrical connections	26
LED indication	29
Check list	30
Communication	32
Power back-up	34
Definitions	36

User's Guide

Before you start

Save energy - save money - improve your comfort temperature

The ECL Comfort controller is designed by Danfoss for the automatic temperature control of heating systems.

The advantages of the ECL Comfort controller system are the security of your heating control and the optimum use of energy resources.

Seasonal changes and variations in outdoor temperatures are monitored by the control system.

Decreased temperatures and low energy consumption while you are out or asleep save heating costs.

The temperature programming provides comfort and the automatic pump motion program protects against blocking.

Time control of the ECL Comfort 100M controller

When an analog clock is mounted the controller can reduce or increase the room temperature automatically.

This ensures comfortable temperatures when you are at home and helps you save energy and thus reduce costs while you are out.

User's Guide

Before you start

Save energy - save money - improve your comfort temperature

The ECL Comfort controller is designed by Danfoss for the automatic temperature control of heating systems.

The advantages of the ECL Comfort controller system are the security of your heating control and the optimum use of energy resources.

Seasonal changes and variations in outdoor temperatures are monitored by the control system.

Decreased temperatures and low energy consumption while you are out or asleep save heating costs.

The temperature programming provides comfort and the automatic pump motion program protects against blocking.

Time control of the ECL Comfort 100M controller

When an analog clock is mounted the controller can reduce or increase the room temperature automatically.

This ensures comfortable temperatures when you are at home and helps you save energy and thus reduce costs while you are out.

Operating the controller

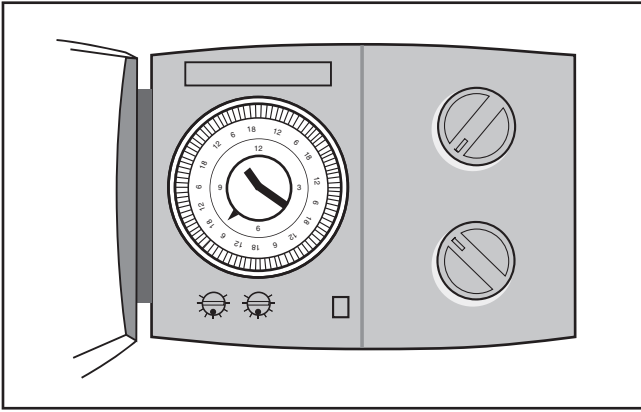

4

Operating the controller

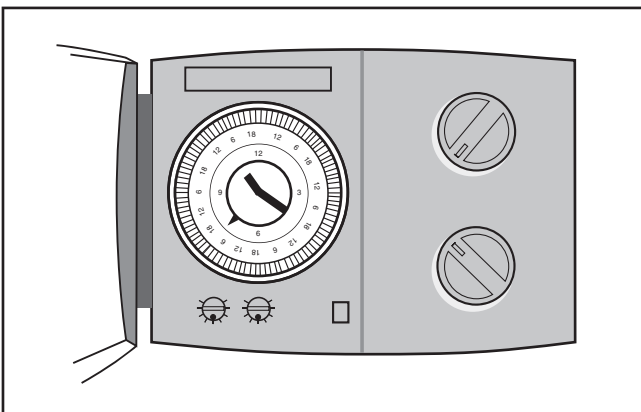

4

Setting the clock

Clock (optional)

A clock can be mounted when an automatic change between comfort temperature and reduced temperature is desired.

Setting the clock

Turn the minute hand to set the actual week day (7-day clock) and time.

Note!

You will move the entire outer ring of the clock with its sliders, just by turning the minute hand. Turn the minute hand until the white arrow points at the actual week day and hour in the outer ring.

Note!

Do not turn anti-clockwise, as this may damage the clock.

Summer time setting

Remember to set summer- and wintertime +/- 1 hour.

Individual comfort and reduced temperature periods

Determine in which periods of time you want comfort temperature or reduced temperature. Look at the week days and hours written in the outer ring of the clock. You can choose heating at comfort temperature by setting the sliders in the outer ring to point towards the center. If you set the sliders to point outwards, you set the heating system to reduce temperature at the corresponding period of time.

5

Setting the clock

Clock (optional)

A clock can be mounted when an automatic change between comfort temperature and reduced temperature is desired.

Setting the clock

Turn the minute hand to set the actual week day (7-day clock) and time.

Note!

You will move the entire outer ring of the clock with its sliders, just by turning the minute hand. Turn the minute hand until the white arrow points at the actual week day and hour in the outer ring.

Note!

Do not turn anti-clockwise, as this may damage the clock.

Summer time setting

Remember to set summer- and wintertime +/- 1 hour.

Individual comfort and reduced temperature periods

Determine in which periods of time you want comfort temperature or reduced temperature. Look at the week days and hours written in the outer ring of the clock. You can choose heating at comfort temperature by setting the sliders in the outer ring to point towards the center. If you set the sliders to point outwards, you set the heating system to reduce temperature at the corresponding period of time.

5

Controller mode

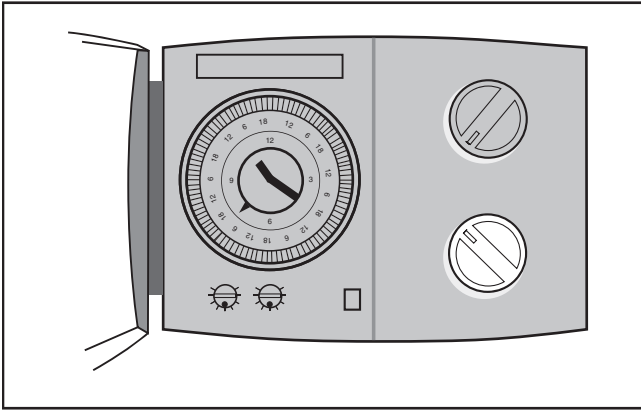



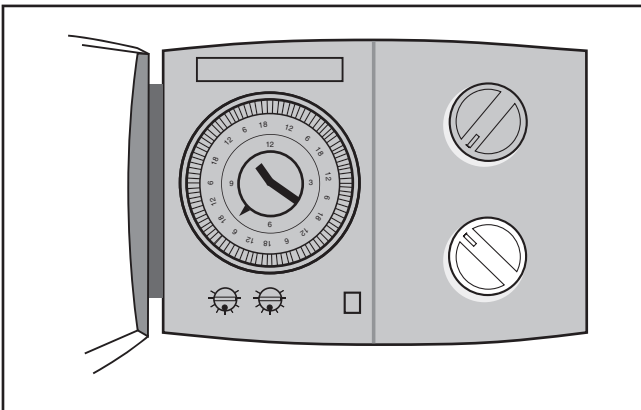

6

Controller mode







6

What do the symbols mean?

-  **Manual operation.** Used only at maintenance and service.
Note! The system protection against frost is switched off when this mode is selected.
-  **Constant comfort temperature.** The day plan is not in operation. Used when extended periods of comfort temperature are desired, i.e. a day off work or a late-night party.
-  **Automatic operation.** This is the normal mode.
 - *If a clock is mounted:* The temperature is controlled according to your day plan with automatic changeover between comfort and reduced temperatures.
 - *If there is no clock:* The temperature is controlled at a comfort temperature.
-  **Constantly reduced temperature.** The day plan is not in operation. Use this mode when you are away on holiday, etc.
-  **Standby.** Heating is stopped. The system is protected against frost. Use this mode during the summer.

7

What do the symbols mean?

-  **Manual operation.** Used only at maintenance and service.
Note! The system protection against frost is switched off when this mode is selected.
-  **Constant comfort temperature.** The day plan is not in operation. Used when extended periods of comfort temperature are desired, i.e. a day off work or a late-night party.
-  **Automatic operation.** This is the normal mode.
 - *If a clock is mounted:* The temperature is controlled according to your day plan with automatic changeover between comfort and reduced temperatures.
 - *If there is no clock:* The temperature is controlled at a comfort temperature.
-  **Constantly reduced temperature.** The day plan is not in operation. Use this mode when you are away on holiday, etc.
-  **Standby.** Heating is stopped. The system is protected against frost. Use this mode during the summer.

7

Temperature setting

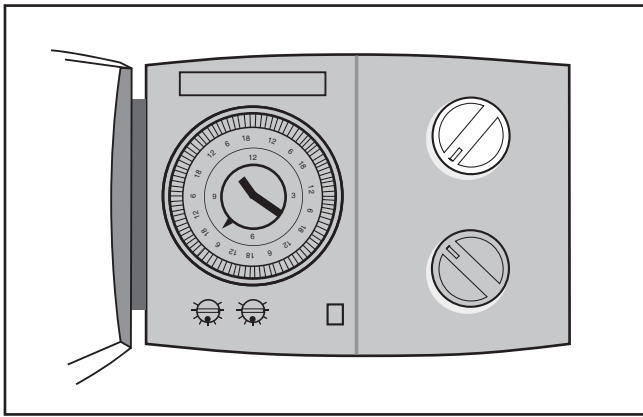

8

Temperature setting

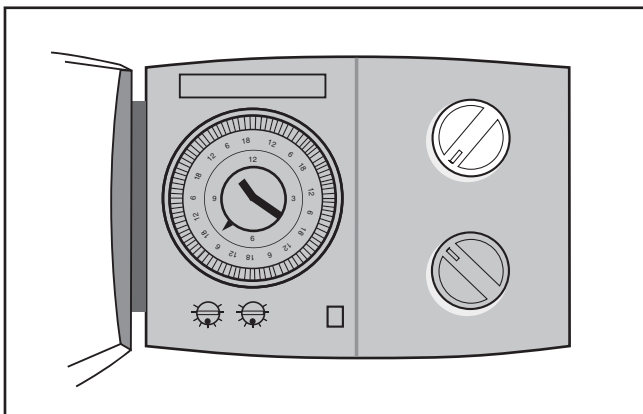

8

Temperature setting without room sensor (parallel displacement of the heat curve)

If you have no room sensor installed, your system will not know the exact room temperature. Therefore you can only use the temperature setting button to change the flow temperature. This corresponds approx. to a possible change in room temperature of +/- 8 °C.

Temperature setting with room sensor

If you have a room sensor installed, the midpoint of the temperature setting button will correspond to a room temperature of 20 °C. The room temperature can be set in a range from 12 to 28 °C.

Adjustments

- **With room sensor.**

If the wanted comfort temperature is not reached?

Make sure that the radiator thermostat/valve is fully open in the room with the room sensor.

- **Without room sensor.**

The rooms seem to be too cold?

Before adjusting the comfort temperature on the controller it is advisable to check and perhaps adjust the settings of your radiator thermostats/valves.

If you are not able to obtain the desired temperature by these adjustments, the flow temperature is too low. Increase the value.

See also page 12: Setting the heat curve.

9

Temperature setting without room sensor (parallel displacement of the heat curve)

If you have no room sensor installed, your system will not know the exact room temperature. Therefore you can only use the temperature setting button to change the flow temperature. This corresponds approx. to a possible change in room temperature of +/- 8 °C.

Temperature setting with room sensor

If you have a room sensor installed, the midpoint of the temperature setting button will correspond to a room temperature of 20 °C. The room temperature can be set in a range from 12 to 28 °C.

Adjustments

- **With room sensor.**

If the wanted comfort temperature is not reached?

Make sure that the radiator thermostat/valve is fully open in the room with the room sensor.

- **Without room sensor.**

The rooms seem to be too cold?

Before adjusting the comfort temperature on the controller it is advisable to check and perhaps adjust the settings of your radiator thermostats/valves.

If you are not able to obtain the desired temperature by these adjustments, the flow temperature is too low. Increase the value.

See also page 12: Setting the heat curve.

9

Temperature reduction

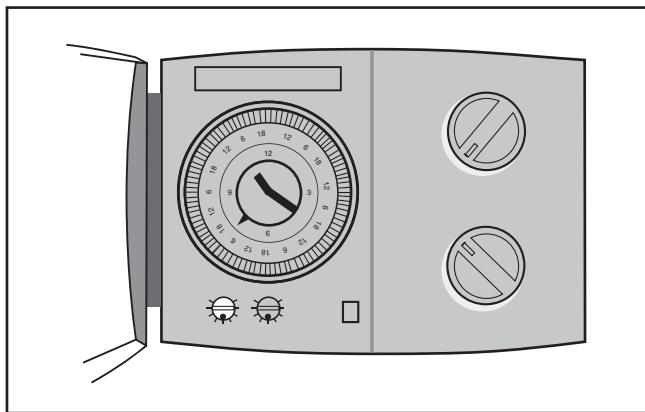

Temperature reduction in reduced temperature mode

You can choose how many degrees you want the flow temperature / room temperature to be decreased in time periods with reduced temperature.

10

The knob (potentiometer) for the temperature reduction can be set in the positions of  (standby), **1 - 14** or **AUTO**:



Heating system on standby

The heating system is stopped, but still protected against frost.

1 - 14

Fixed temperature reduction

Without room sensor: The flow temperature is decreased in order to obtain the desired reduction of the room temperature.

With room sensor: The room temperature is decreased by the set temperature reduction.

AUTO

Variable temperature reduction

The temperature reduction is dependent of the outdoor temperature. However, the temperature will not be reduced if the outdoor temperature is below -8 °C.

11

Temperature reduction

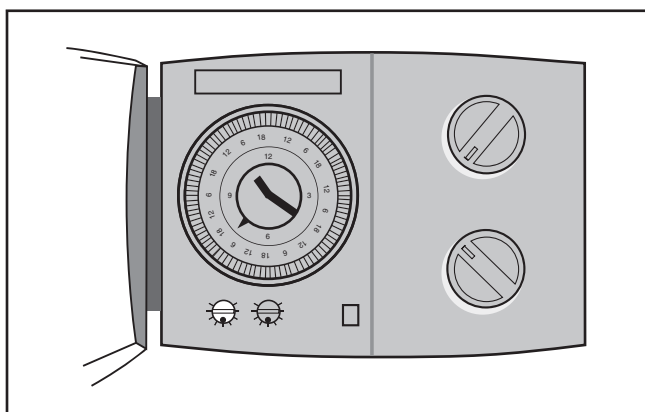

Temperature reduction in reduced temperature mode

You can choose how many degrees you want the flow temperature / room temperature to be decreased in time periods with reduced temperature.

10

The knob (potentiometer) for the temperature reduction can be set in the positions of  (standby), **1 - 14** or **AUTO**:



Heating system on standby

The heating system is stopped, but still protected against frost.

1 - 14

Fixed temperature reduction

Without room sensor: The flow temperature is decreased in order to obtain the desired reduction of the room temperature.

With room sensor: The room temperature is decreased by the set temperature reduction.

AUTO

Variable temperature reduction

The temperature reduction is dependent of the outdoor temperature. However, the temperature will not be reduced if the outdoor temperature is below -8 °C.

11

Setting the heat curve

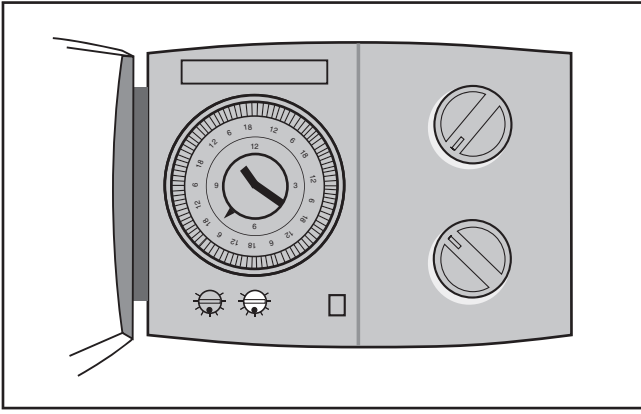

The heat curve shows the relation between the outdoor temperature and the flow temperature of the heating circuit.

12

Setting the heat curve

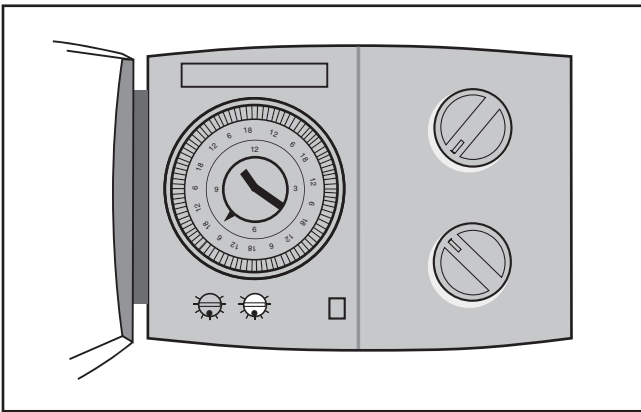

The heat curve shows the relation between the outdoor temperature and the flow temperature of the heating circuit.

12

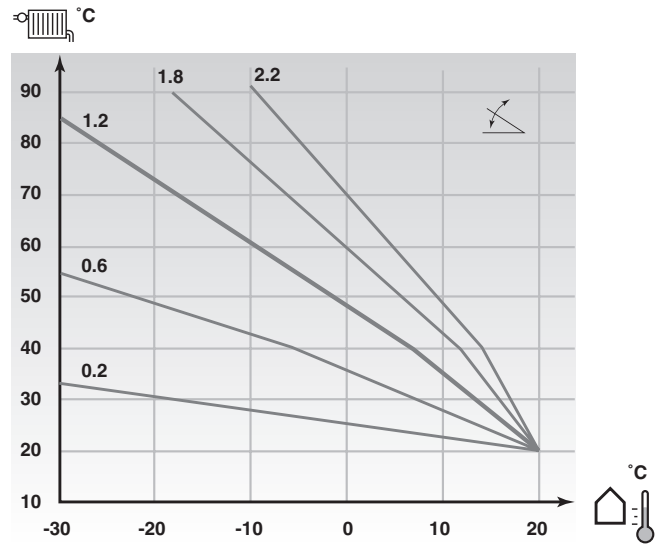

You can set the heating curve slope in the range from 0.2 to 2.2. The slope is factory set to 1.2.

Examples of setting the slope of the heat curve

Outdoor temperature*	Radiator circuit	Floor heating
-25 °C	1.2	0.5
-15 °C	1.6	0.6
-10 °C	1.8	0.7

*) Dimensioning temperature depending on the temperature normal for your area.

13

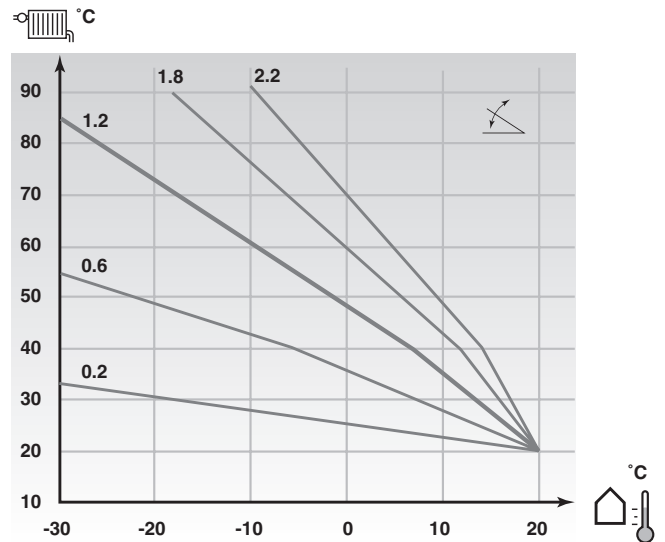

You can set the heating curve slope in the range from 0.2 to 2.2. The slope is factory set to 1.2.

Examples of setting the slope of the heat curve

Outdoor temperature*	Radiator circuit	Floor heating
-25 °C	1.2	0.5
-15 °C	1.6	0.6
-10 °C	1.8	0.7

*) Dimensioning temperature depending on the temperature normal for your area.

13

Controller settings on the rear side

To make the controller ready for operation, you must adjust the controller settings on the rear side.

Mini switches 1 to 8:

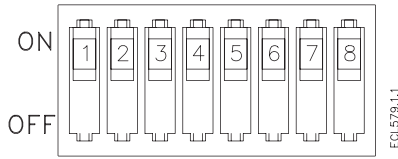

 : Factory setting

Controller settings on the rear side

To make the controller ready for operation, you must adjust the controller settings on the rear side.

Mini switches 1 to 8:

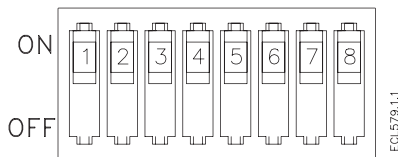

 : Factory setting

Switch 1: Heating cut-out

Switch 1	Cut-out temperature	Your setting
OFF	No cut-out	
ON	 18 °C	

The heating cut-out function helps you save energy. Set the limit for the outdoor temperature at which you want your heating system to stop.

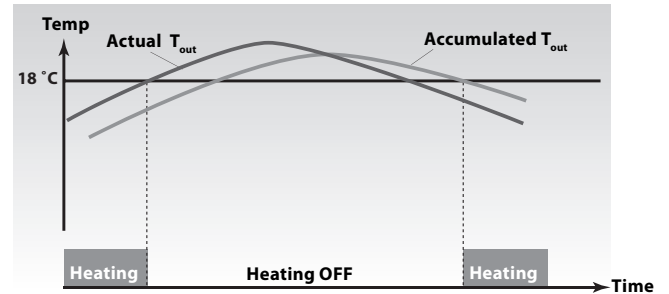

The accumulated T_{out} symbolizes the heat stored in the building.

Switch 2: Minimum flow temperature limit

Switch 2	Min. flow temperature	Your setting
OFF	 10 °C	
ON	35 °C	

Set the acceptable min. limit of the flow temperature in your heating system.

Switch 1: Heating cut-out

Switch 1	Cut-out temperature	Your setting
OFF	No cut-out	
ON	 18 °C	

The heating cut-out function helps you save energy. Set the limit for the outdoor temperature at which you want your heating system to stop.

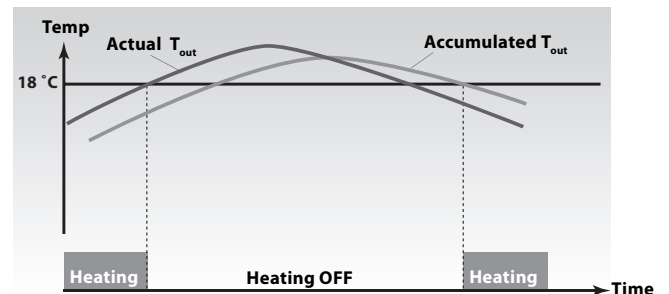

The accumulated T_{out} symbolizes the heat stored in the building.

Switch 2: Minimum flow temperature limit

Switch 2	Min. flow temperature	Your setting
OFF	 10 °C	
ON	35 °C	

Set the acceptable min. limit of the flow temperature in your heating system.

Switch 3: Maximum flow temperature limit

Switch 3	Max. flow temperature	Your setting
OFF	45 °C	
ON	 90 °C	

Set a maximum flow temperature to protect your heating system from getting overheated.

Switch 4: Running time of the motorized valve

Switch 4	Running time	Your setting
OFF	20 sec.	
ON	 120 sec.	

The running time of the motorized valve is the time it takes the valve to move from closed to fully open position. Select the running time of the motorized valve that suits you best. The running time is defined as:

Valve stroke (mm) X **actuator speed** (sec./mm) = **running time**.

If the thermo actuator is selected for switch 5, the setting of switch 4 will be disabled.

Switch 5: Gear motor/thermo actuator

Switch 5	Actuator type	Your setting
OFF	Thermo actuator	
ON	 Gear motor	

Select the gear motor or thermo actuator, depending on what is used in your heating system.

Switches 6, 7 and 8: Addressing and time unit selection

Switch 6	Switch 7	Switch 8	Slave address	Clock	Your setting
OFF	OFF	OFF	 0	built-in	
ON	OFF	OFF	1	built-in	
OFF	ON	OFF	2	built-in	
ON	ON	OFF	3	built-in	
OFF	OFF	ON	4	ECA 60/61 address A	
ON	OFF	ON	5	ECA 60/61 address B	

Set the slave address of the controller, if it is a part of a master/slave system. Set the address of the ECA 60/61, if it is connected. See also page 32.

Switch 3: Maximum flow temperature limit

Switch 3	Max. flow temperature	Your setting
OFF	45 °C	
ON	 90 °C	

Set a maximum flow temperature to protect your heating system from getting overheated.

Switch 4: Running time of the motorized valve

Switch 4	Running time	Your setting
OFF	20 sec.	
ON	 120 sec.	

The running time of the motorized valve is the time it takes the valve to move from closed to fully open position. Select the running time of the motorized valve that suits you best. The running time is defined as:

Valve stroke (mm) X **actuator speed** (sec./mm) = **running time**.

If the thermo actuator is selected for switch 5, the setting of switch 4 will be disabled.

Switch 5: Gear motor/thermo actuator

Switch 5	Actuator type	Your setting
OFF	Thermo actuator	
ON	 Gear motor	

Select the gear motor or thermo actuator, depending on what is used in your heating system.

Switches 6, 7 and 8: Addressing and time unit selection

Switch 6	Switch 7	Switch 8	Slave address	Clock	Your setting
OFF	OFF	OFF	 0	built-in	
ON	OFF	OFF	1	built-in	
OFF	ON	OFF	2	built-in	
ON	ON	OFF	3	built-in	
OFF	OFF	ON	4	ECA 60/61 address A	
ON	OFF	ON	5	ECA 60/61 address B	

Set the slave address of the controller, if it is a part of a master/slave system. Set the address of the ECA 60/61, if it is connected. See also page 32.

Installation and maintenance

Before you start

Save energy - save money - improve your comfort temperature

The ECL Comfort controller is designed by Danfoss for temperature control of heating systems.

The ECL Comfort ensures you of the following;

- Room temperatures will be adjusted to your personal settings.
- Lower temperatures and lower energy consumption reduce costs and ensure optimum use of energy resources.
- The automatic pump motion program protects the circulation pump against blocking.

Installation and maintenance

Before you start

Save energy - save money - improve your comfort temperature

The ECL Comfort controller is designed by Danfoss for temperature control of heating systems.

The ECL Comfort ensures you of the following;

- Room temperatures will be adjusted to your personal settings.
- Lower temperatures and lower energy consumption reduce costs and ensure optimum use of energy resources.
- The automatic pump motion program protects the circulation pump against blocking.

Identifying the system type

The ECL Comfort controller is capable of controlling different heating systems. These standard system types cover a variety of system compositions.

If your system is not quite as the diagrams of the most frequently used systems, find the diagram with the best resemblance with your system and make your own combinations.

Note!

System diagrams in this instruction are principal drawings and do not contain all components which are necessary in heating systems.

Heating system type 1: Direct district heating

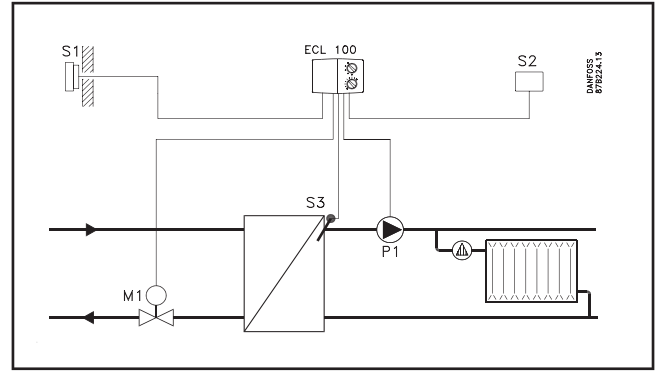

Heating system type 2: Boiler system

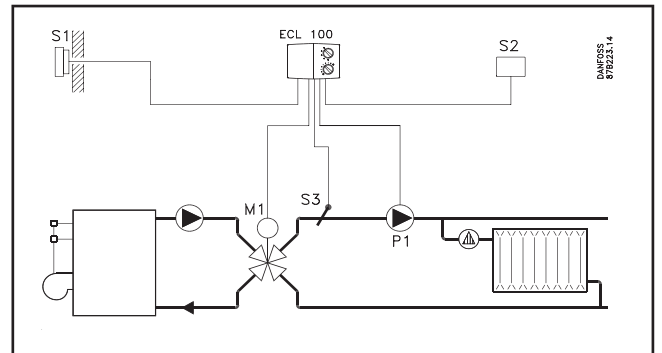

Identifying the system type

The ECL Comfort controller is capable of controlling different heating systems. These standard system types cover a variety of system compositions.

If your system is not quite as the diagrams of the most frequently used systems, find the diagram with the best resemblance with your system and make your own combinations.

Note!

System diagrams in this instruction are principal drawings and do not contain all components which are necessary in heating systems.

Heating system type 1: Direct district heating

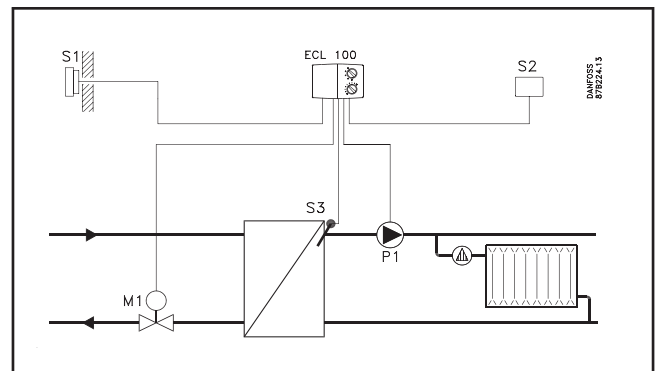

Heating system type 2: Boiler system

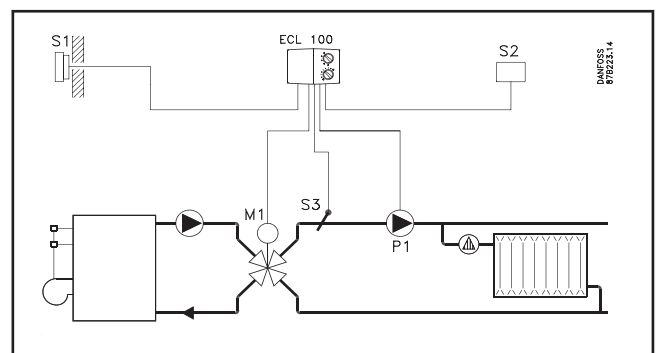

Mounting the controller

You should mount the ECL Comfort controller for easy access near the heating unit. You can choose between three methods:

- Mounting in a panel
- Mounting on a wall
- Mounting on a DIN rail

Screws and rawlplugs are not supplied with this package.

Mounting in a panel

Order mounting kit No. 087B1148.

The panel plate thickness must not exceed 3 mm. Prepare a cutout measuring 92 x 138 mm. Establish the electrical connections. Insert the controller into the panel cutout and fix it with the two locks which are placed diagonally in the two corners of the controller.

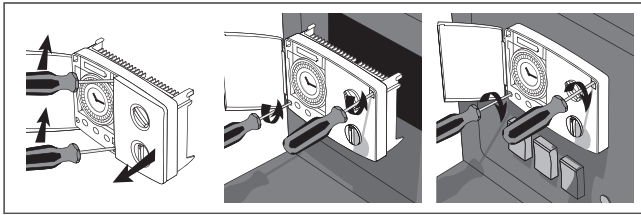

22

Mounting the controller

You should mount the ECL Comfort controller for easy access near the heating unit. You can choose between three methods:

- Mounting in a panel
- Mounting on a wall
- Mounting on a DIN rail

Screws and rawlplugs are not supplied with this package.

Mounting in a panel

Order mounting kit No. 087B1148.

The panel plate thickness must not exceed 3 mm. Prepare a cutout measuring 92 x 138 mm. Establish the electrical connections. Insert the controller into the panel cutout and fix it with the two locks which are placed diagonally in the two corners of the controller.

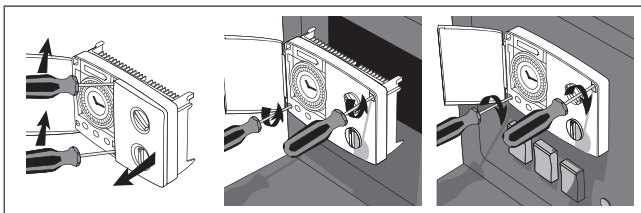

22

Mounting on a wall

Order mounting kit No. 087B1154.

Mount the terminal box on a wall with a smooth surface. Establish the electrical connections and position the controller in the box. Secure the controller by the fixing screw.

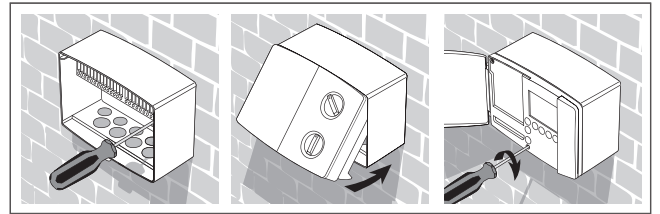

Mounting on a DIN rail

Order mounting kit No. 087B1145.

A mounting kit is necessary to mount the box with the controller on a DIN rail.

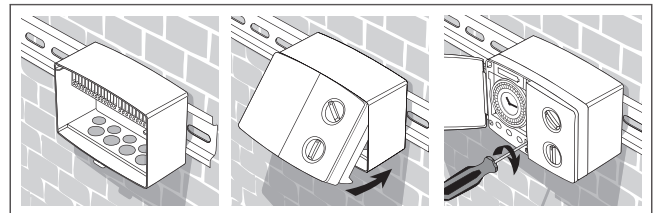

23

Mounting on a wall

Order mounting kit No. 087B1154.

Mount the terminal box on a wall with a smooth surface. Establish the electrical connections and position the controller in the box. Secure the controller by the fixing screw.

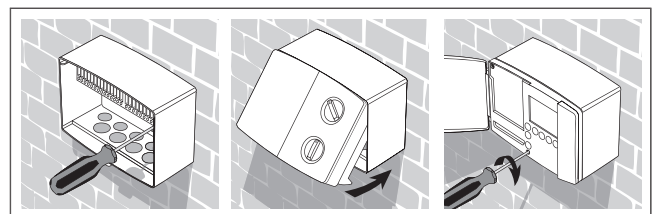

Mounting on a DIN rail

Order mounting kit No. 087B1145.

A mounting kit is necessary to mount the box with the controller on a DIN rail.

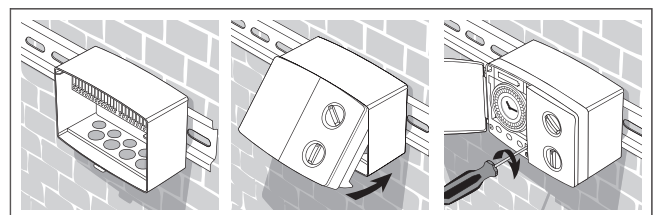

23

Placing the temperature sensor types

It is important that the sensors are mounted in the correct position in your heating system.

Outdoor temperature sensor (ESMT type)

The outdoor sensor should be mounted on the north side of the building where it is less likely to be exposed to direct sunshine. It should not be placed close to doors or windows.

Flow temperature sensor (ESMU, ESM-11 or ESMC types)

Place the sensor max. 15 cm from the mixing point. In systems with heat exchanger, Danfoss recommends the ESMU-type to be inserted into the exchanger flow outlet. Make sure that the surface of the pipe is clean where the sensor is to be mounted.

Note!

Valid for ESM-11: Do not move the sensor after it has been fastened in order to avoid damage to the sensor element.

24

Placing the temperature sensor types

It is important that the sensors are mounted in the correct position in your heating system.

Outdoor temperature sensor (ESMT type)

The outdoor sensor should be mounted on the north side of the building where it is less likely to be exposed to direct sunshine. It should not be placed close to doors or windows.

Flow temperature sensor (ESMU, ESM-11 or ESMC types)

Place the sensor max. 15 cm from the mixing point. In systems with heat exchanger, Danfoss recommends the ESMU-type to be inserted into the exchanger flow outlet. Make sure that the surface of the pipe is clean where the sensor is to be mounted.

Note!

Valid for ESM-11: Do not move the sensor after it has been fastened in order to avoid damage to the sensor element.

24

Room temperature sensor (ESM-10, ECA 60 and 61 remote controls)

Place the room sensor in the room where the temperature is to be controlled. Do not place it on outside walls or close to radiators, windows or doors.

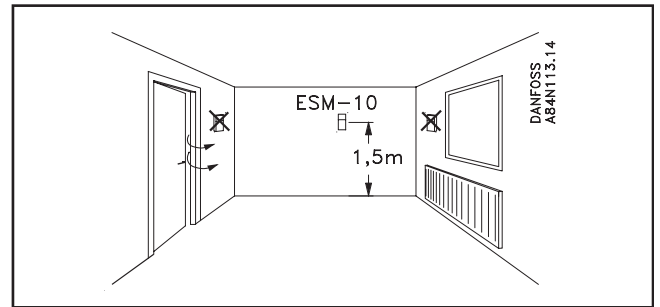

25

Room temperature sensor (ESM-10, ECA 60 and 61 remote controls)

Place the room sensor in the room where the temperature is to be controlled. Do not place it on outside walls or close to radiators, windows or doors.

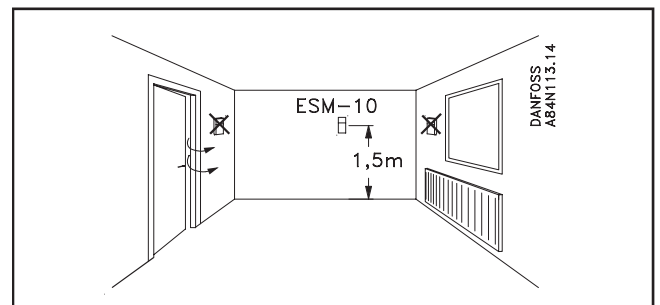

25

Electrical connections 230 V a.c.

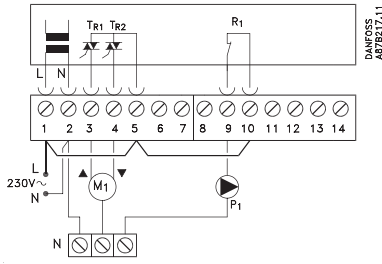

Terminal	Description	Max. load	
1	L	Voltage supply 230 V a.c.	
2	N	Voltage supply 230 V a.c.	
3	M1	Gear motor - open	0.2 VA 230 V a.c.
4	M1	Gear motor - close alt.: ABV thermo actuator	0.2 VA 230 V a.c.
5		230 V a.c. supply for M1	
9	P1	Circulation pump for heating circuit	4(2)A 230 V a.c.
10		230 V a.c. supply for P1	

Establish these jumpers:

- Jumper from 1 to 5
- Jumper from 5 to 10
- Jumper from 2 to common N-terminal

Electrical connections: Max. 2 x 1.5 mm² cables can be inserted in each screw terminal (max. cable length: 50 m).
Important: Wrong connections cause damaged TRIAC outlets.

26

Electrical connections 24 V a.c.

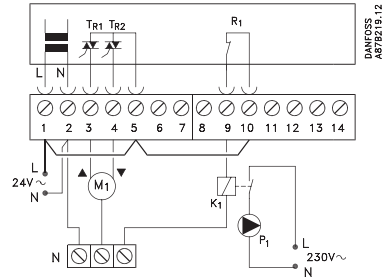

Terminal	Description	Max. load	
1	L	Voltage supply 24 V a.c.	
2	N	Voltage supply 24 V a.c.	
3	M1	Gear motor - open	1A 24 V a.c.
4	M1	Gear motor - close alt.: ABV thermo actuator	1A 24 V a.c.
5		24 V a.c. supply for M1	
9	K1	Relay for circulation pump	4(2) A 24 V a.c.
10		24 V a.c. supply for K1	

Establish these jumpers:

- Jumper from 1 to 5
- Jumper from 5 to 10
- Jumper from 2 to common N-terminal

Electrical connections: Max. 2 x 1.5 mm² cables can be inserted in each screw terminal (max. cable length: 50 m).
Important: Wrong connections cause damaged TRIAC outlets.

27

Electrical connections 230 V a.c.

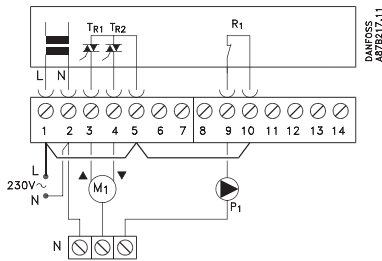

Terminal	Description	Max. load	
1	L	Voltage supply 230 V a.c.	
2	N	Voltage supply 230 V a.c.	
3	M1	Gear motor - open	0.2 VA 230 V a.c.
4	M1	Gear motor - close alt.: ABV thermo actuator	0.2 VA 230 V a.c.
5		230 V a.c. supply for M1	
9	P1	Circulation pump for heating circuit	4(2)A 230 V a.c.
10		230 V a.c. supply for P1	

Establish these jumpers:

- Jumper from 1 to 5
- Jumper from 5 to 10
- Jumper from 2 to common N-terminal

Electrical connections: Max. 2 x 1.5 mm² cables can be inserted in each screw terminal (max. cable length: 50 m).
Important: Wrong connections cause damaged TRIAC outlets.

26

Electrical connections 24 V a.c.

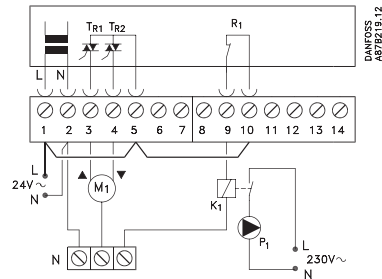

Terminal	Description	Max. load	
1	L	Voltage supply 24 V a.c.	
2	N	Voltage supply 24 V a.c.	
3	M1	Gear motor - open	1A 24 V a.c.
4	M1	Gear motor - close alt.: ABV thermo actuator	1A 24 V a.c.
5		24 V a.c. supply for M1	
9	K1	Relay for circulation pump	4(2) A 24 V a.c.
10		24 V a.c. supply for K1	

Establish these jumpers:

- Jumper from 1 to 5
- Jumper from 5 to 10
- Jumper from 2 to common N-terminal

Electrical connections: Max. 2 x 1.5 mm² cables can be inserted in each screw terminal (max. cable length: 50 m).
Important: Wrong connections cause damaged TRIAC outlets.

27

Electrical connections - sensors

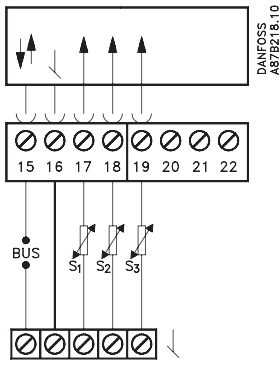

Terminal	Description	Type
15 and 16	ECL Comfort BUS	
17 and 16	Outdoor sensor (S1)	ESMT
18 and 16	Room sensor (S2)	ESM-10
19 and 16	Flow sensor (S3)	ESMU/ESM-11/ESMC

Establish the jumper from 16 to common terminal

Cable cross section for sensor connections: Min. 0.4 mm²
 Total cable length: Max. 50 m (sensors and bus).
 NOTE! Cable lengths above 100 m may cause noise sensibility (EMC).

28

Electrical connections - sensors

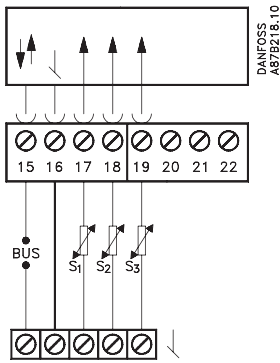

Terminal	Description	Type
15 and 16	ECL Comfort BUS	
17 and 16	Outdoor sensor (S1)	ESMT
18 and 16	Room sensor (S2)	ESM-10
19 and 16	Flow sensor (S3)	ESMU/ESM-11/ESMC

Establish the jumper from 16 to common terminal

Cable cross section for sensor connections: Min. 0.4 mm²
 Total cable length: Max. 50 m (sensors and bus).
 NOTE! Cable lengths above 100 m may cause noise sensibility (EMC).

28

LED indication

Function test

The LED indicator shows whether the 100M is in operation or not. When testing sensors and controller, the control status and faults are shown.

Control status

At normal operation with the function switch in the positions , , or the indicator lights.

Constant light: The flow temperature is in the neutral zone and the motor does not receive signals. The valve is not activated.

Constant light with two interruptions: The flow temperature is below the neutral zone. The motor opens the valve.

Constant light with three interruptions: The flow temperature is above the neutral zone. The motor closes the valve.

Note! The indication does not follow the signals.

Test of controller and sensors

Turn the function switch in position . After about five sec. the lamp will flash and show the test result. The result is shown every third sec.

No light: The controller is defective or the flow temperature sensor is not mounted.

Constant light with 1, 2 or 3 intervals: The number of intervals must correspond to the number of connected sensors. If the number is not correct, one or more sensors might be short-circuited or disconnected.

Constant light: The controller is defective.

29

LED indication

Function test

The LED indicator shows whether the 100M is in operation or not. When testing sensors and controller, the control status and faults are shown.

Control status

At normal operation with the function switch in the positions , , or the indicator lights.

Constant light: The flow temperature is in the neutral zone and the motor does not receive signals. The valve is not activated.

Constant light with two interruptions: The flow temperature is below the neutral zone. The motor opens the valve.

Constant light with three interruptions: The flow temperature is above the neutral zone. The motor closes the valve.

Note! The indication does not follow the signals.

Test of controller and sensors

Turn the function switch in position . After about five sec. the lamp will flash and show the test result. The result is shown every third sec.

No light: The controller is defective or the flow temperature sensor is not mounted.

Constant light with 1, 2 or 3 intervals: The number of intervals must correspond to the number of connected sensors. If the number is not correct, one or more sensors might be short-circuited or disconnected.

Constant light: The controller is defective.

29

Check list

Is the ECL Comfort controller ready for use?

- Make sure that the power supply is wired correctly to the terminals 1 (Live) and 2 (Neutral). See page 26.
- Check the settings on the controller's rear side. See page 14: *Controller settings on the rear side.*
- Check that pumps and valves are connected to the correct terminals. See page 26: *Electrical connections*

- Check that all sensors are connected to the correct terminals. See page 28: *Electrical connections - sensor*
- Mount the controller, switch on the power.
- You can check the turning direction of the motorized valve either by looking at it or by feeling whether the temperature of the actual pipe changes as expected.
- The LED indicator shows whether the 100M is operating or not. The indicator can also show control status and faults when testing sensors and controller. See page 29: *LED indication*

Check list

Is the ECL Comfort controller ready for use?

- Make sure that the power supply is wired correctly to the terminals 1 (Live) and 2 (Neutral). See page 26.
- Check the settings on the controller's rear side. See page 14: *Controller settings on the rear side.*
- Check that pumps and valves are connected to the correct terminals. See page 26: *Electrical connections*

- Check that all sensors are connected to the correct terminals. See page 28: *Electrical connections - sensor*
- Mount the controller, switch on the power.
- You can check the turning direction of the motorized valve either by looking at it or by feeling whether the temperature of the actual pipe changes as expected.
- The LED indicator shows whether the 100M is operating or not. The indicator can also show control status and faults when testing sensors and controller. See page 29: *LED indication*

Communication

The ECL Comfort controller can be connected to external units via the ECL Comfort BUS.

Master / slave systems

If the controller is part of a larger system with several controllers, you can connect the controllers with each other and send information to them using the same outdoor sensor. The controller which is physically connected with the outdoor sensor is the master of the entire system and gets the address 15. The other controllers in the system can be addressed with a slave number and receive information from the outdoor sensor through the master.

If a slave has an address higher than 0, a reference temperature demand can be sent to the master. The master sends an outdoor temperature signal to the slaves. When a slave has the address 0, only the outdoor temperature signal is transferred from the master to the slave.

Communication

The ECL Comfort controller can be connected to external units via the ECL Comfort BUS.

Master / slave systems

If the controller is part of a larger system with several controllers, you can connect the controllers with each other and send information to them using the same outdoor sensor. The controller which is physically connected with the outdoor sensor is the master of the entire system and gets the address 15. The other controllers in the system can be addressed with a slave number and receive information from the outdoor sensor through the master.

If a slave has an address higher than 0, a reference temperature demand can be sent to the master. The master sends an outdoor temperature signal to the slaves. When a slave has the address 0, only the outdoor temperature signal is transferred from the master to the slave.

Power back-up

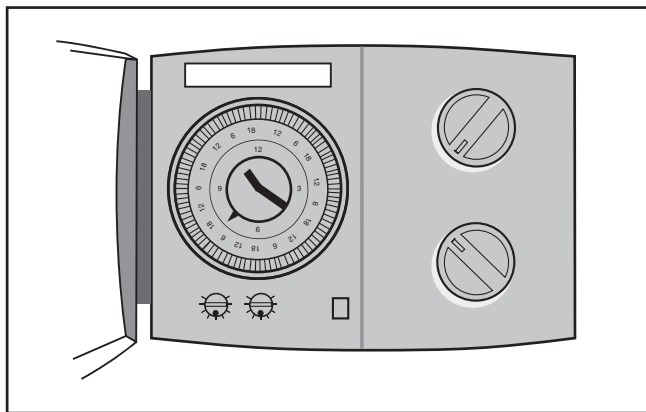

Power back-up for your ECL Comfort controller

To ensure power back-up there is a battery placed above the clock. Normally this battery is not in operation. However Danfoss recommends to replace it every 2 years. Use an Alkaline AAA 1.5 V type.

Remove the battery holder and replace the battery.
Remount the holder again.

34

35

Power back-up

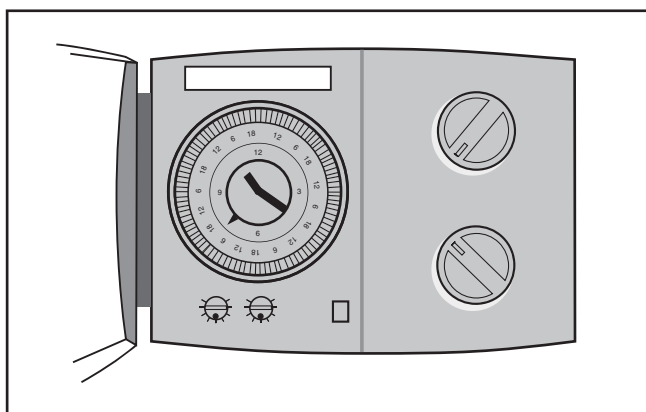

Power back-up for your ECL Comfort controller

To ensure power back-up there is a battery placed above the clock. Normally this battery is not in operation. However Danfoss recommends to replace it every 2 years. Use an Alkaline AAA 1.5 V type.

Remove the battery holder and replace the battery.
Remount the holder again.

34

35

Definitions

Actual flow temperature

The temperature that is measured in the flow at any time.

Comfort period

A period of the day where comfort temperature is selected.

Comfort temperature

The temperature maintained in the heating or hot water circuits during comfort periods, which normally means during daytime.

Function selector

A facility which makes it possible to override the mode of the controller.

36

Heating circuit

The circuit for heating the room/building.

Pt 1000 ohm sensor

All sensors used with the ECL Comfort controller is based on the Pt 1000 ohm type. The resistance is 1000 ohms at 0 °C and it changes with 3.9 ohms/degree C.

Reduced temperature

A period with decreased temperature.

Room sensor

A sensor placed in the room where the temperature is to be controlled. The sensor is based on the Pt 1000 ohm type.

Room temperature

The temperature measured with the room sensor. The room temperature can be controlled only when the sensor is installed.

Weather compensation

A facility that enables the controller to take the outdoor temperature into consideration for heating control. This control is based on a user definable heat curve which determines what the flow temperature should be when the outdoor temperature varies.

37

Definitions

Actual flow temperature

The temperature that is measured in the flow at any time.

Comfort period

A period of the day where comfort temperature is selected.

Comfort temperature

The temperature maintained in the heating or hot water circuits during comfort periods, which normally means during daytime.

Function selector

A facility which makes it possible to override the mode of the controller.

36

Heating circuit

The circuit for heating the room/building.

Pt 1000 ohm sensor

All sensors used with the ECL Comfort controller is based on the Pt 1000 ohm type. The resistance is 1000 ohms at 0 °C and it changes with 3.9 ohms/degree C.

Reduced temperature

A period with decreased temperature.

Room sensor

A sensor placed in the room where the temperature is to be controlled. The sensor is based on the Pt 1000 ohm type.

Room temperature

The temperature measured with the room sensor. The room temperature can be controlled only when the sensor is installed.

Weather compensation

A facility that enables the controller to take the outdoor temperature into consideration for heating control. This control is based on a user definable heat curve which determines what the flow temperature should be when the outdoor temperature varies.

37

