

048-OPAC-9H

DELLA®

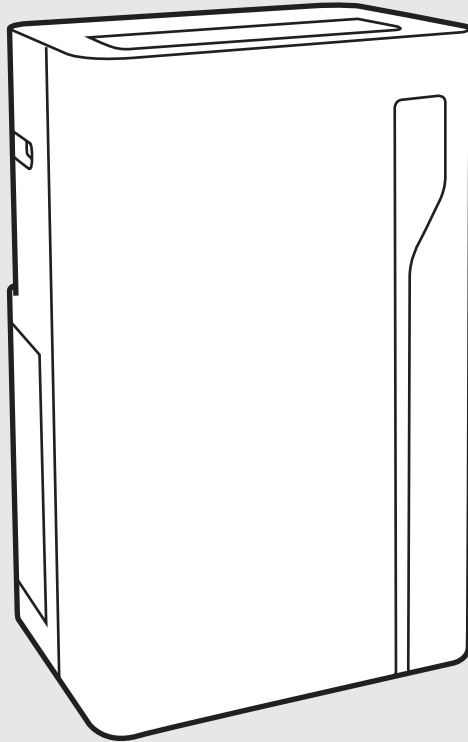

Instruction Manual

This manual contains the information you need to install and use your product. Keep the this manual for future reference.

Table of Contents

Warning and Safety -----	04
Product Specification -----	06
Parts Details -----	07
Installation Guide -----	09
Control Panel -----	13
Remote Control -----	14
Operation Instructions -----	16
Care and Maintenance -----	23
Troubleshooting -----	25
Disposal Guideline -----	26

Warning and Safety

*Read this guide before installation and using this appliance. Failure to follow the safety instructions may result in property damage, serious injury, or death.

DANGER

Indicates an **imminently** hazardous situation that, if not avoided, will result in death, serious injury, or serious property damage.

WARNING

Indicates a **potentially** hazardous situation that, if not avoided, will result in death, serious injury, or serious property damage.

CAUTION

Indicates a **potentially** hazardous situation that, if not avoided, will result in minor to moderate injury. It may also be used to indicate unsafe practices.

DANGER

- In the case of the appliance emitting smoke or burning smell, shut down the appliance and disconnect from the power supply immediately.
- This appliance uses R32 refrigerant. Handle the air conditioner with care and check if there is any refrigerant leakage. In the case of refrigerant leakage, shut down the appliance and disconnect from the power supply. Contact a qualified technician for inspection. Refrigerant can be toxic and flammable. Rapid evaporation of refrigerant may cause frostbite, cardiac arrhythmia, and / or skin irritation.

WARNING

- This appliance must be plugged directly into a wall power socket. Do not connect this appliance to a power strip, extension cord, surge protector, timers, or direct breaker.
- Ensure the voltage and current rating of the power supply corresponds to that on the product specification.
- Make sure the appliance is connected to a properly grounded power outlet only.
- Do not use the appliance with a damaged cord or plug, or after the appliance malfunctions, has been dropped, or damaged in any manner.
- This appliance is designed to be used indoors only. Do not use this appliance outdoor or expose it to outdoors elements such as rain, snow, sunlight, wind, or extreme temperatures.
- Do not place or use the appliance in the bathroom, laundry area, or places that might come into contact with water.
- Do not use this appliance near flammable substances such as alcohol, gasoline, paint, etc. Or pressurized containers such as spray cans.
- Repairs should be carried out by a professional or qualified technician only. Incorrect repair could expose the user to potential electric shock or other kinds of hazards.
- Do not place the appliance in contact with water. The electrical insulation could be damaged and thus cause electric shock.
- Do not bend, tug, pull or compress the power cord to prevent damaging the power cord.

Warning and Safety

CAUTION

- Do not run the power cord under the carpet or cover the cord with throw rugs, runners, or similar covering. Arrange the cord away from high traffic area to prevent tripping over it.
- Only use this appliance as described in this manual.
- Do not obstruct the air inlet or outlet.
- Do not use abrasive solvents to clean this appliance.
- Proper adult supervision is required when using this appliance when there are children, persons with reduced physical, sensory, or mental capabilities, or pets present.
- Do not leave the appliance operating unattended.
- Do not touch any moving parts when the air conditioner is in operation.

Product Specification

Model	048-OPAC-9H
Rated Voltage	115 V
Frequency	60 Hz
Cooling Capacity	14000 BTU / h
Heating Capacity	11669 BTU / h
Recommended Room Size	Up to 550 sq.ft
Dehumidification	68 Pint / Day
Noice Level	54 - 56 dB
Refrigerant Type, Charge	R32, 13.76 oz
Dimension	17.3" x 13.2"x 26.2"
Net Weight	63.9 lb
Operation Temperature	61°F - 90°F (Cooling Mode) 41°F - 81°F (Heating Mode)

Parts Details

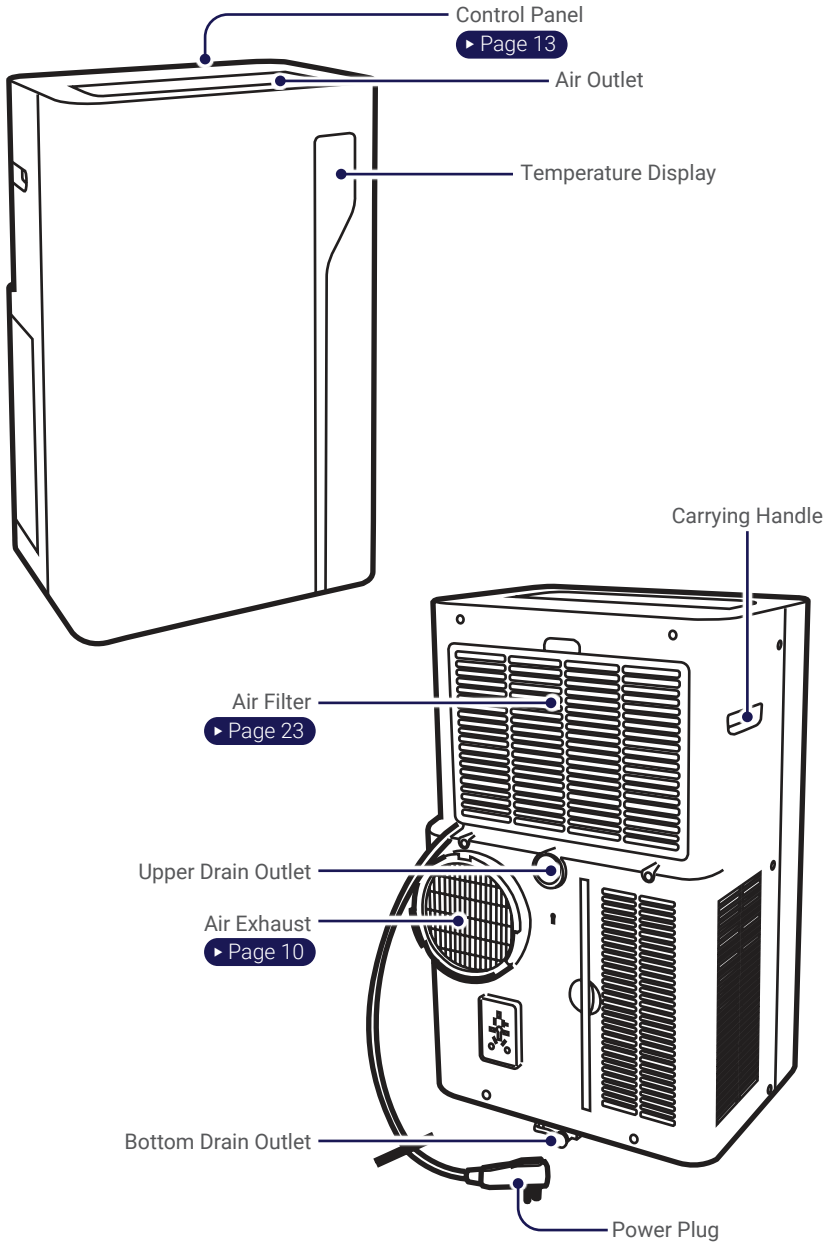

NOTE:

- The graphical representation might have slight differences than the actual product.

Parts Details

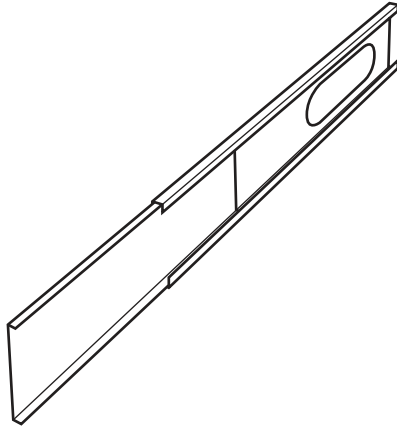

Window Slider Kit
1x



Drain Hose
1x

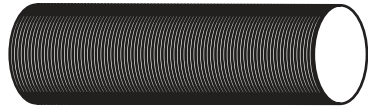

Exhaust Hose
1x



Hose Connector
1x

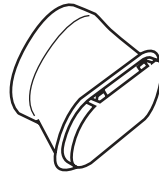

Window Kit Adapter
1x

Installation Guide

Picking a installation location

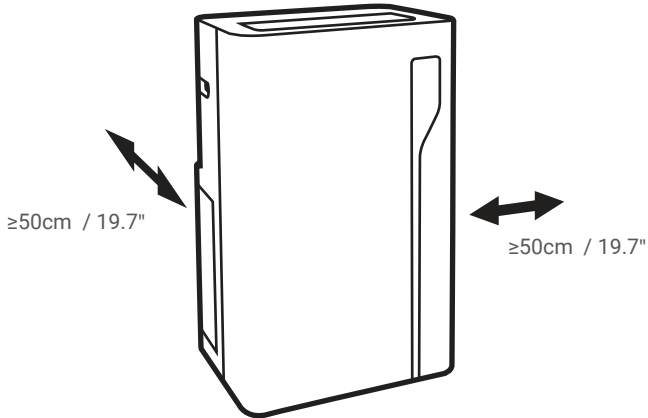

- The air conditioner must be placed on a flat ground.
- Keep the air conditioner at least 50 cm or 19.7" away from any wall or obstacles.
- Do not place the air conditioner in laundry room or near any open ignition sources such as open flames, gas appliance, or electric heater.

Connecting the exhaust hose

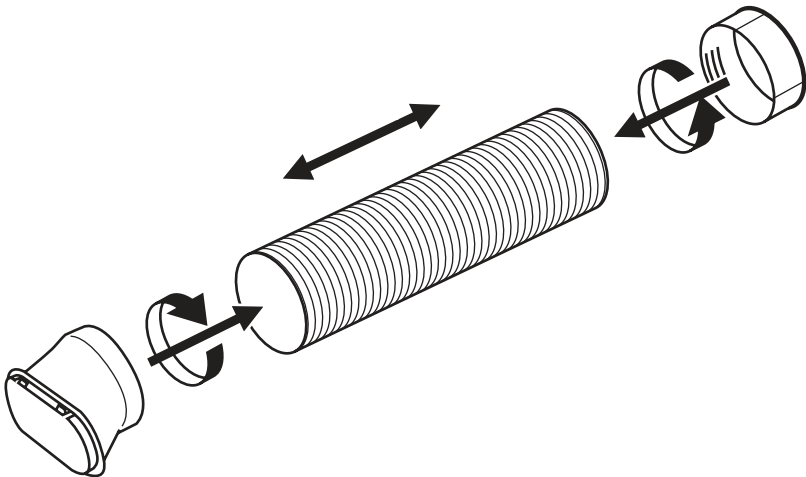

- Connect the exhaust hose to the hose connector and window kit adapter.

Installation Guide

Extending the window slider kit

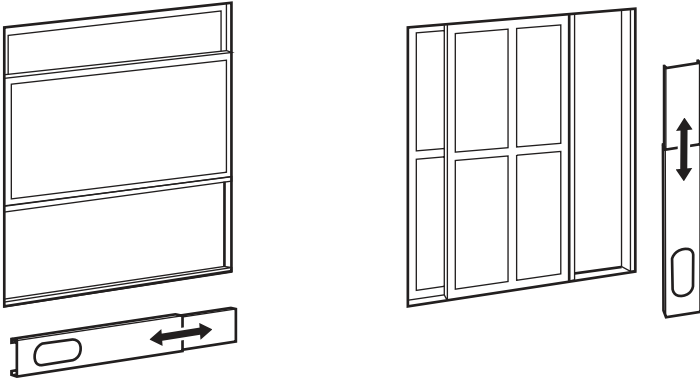

- Adjust the length of the window slider kit according to your window, and then secure the position with the provided screws.

Attaching exhaust hose to the unit

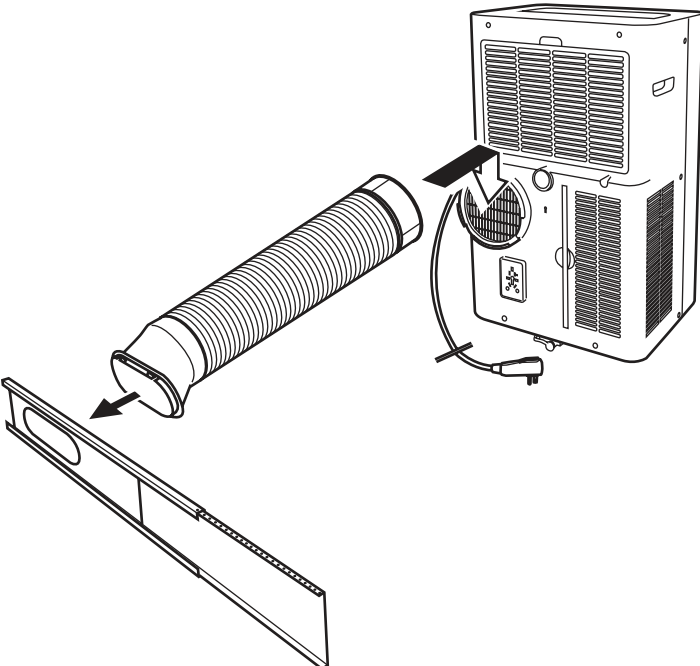

- Slide the hose connector to the air exhaust on the unit, and attach the window kit adapter to the window slider kit.

Installation Guide

Connecting exhaust hose to the window

Vertical Window

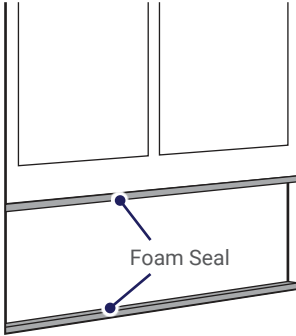

Horizontal Window

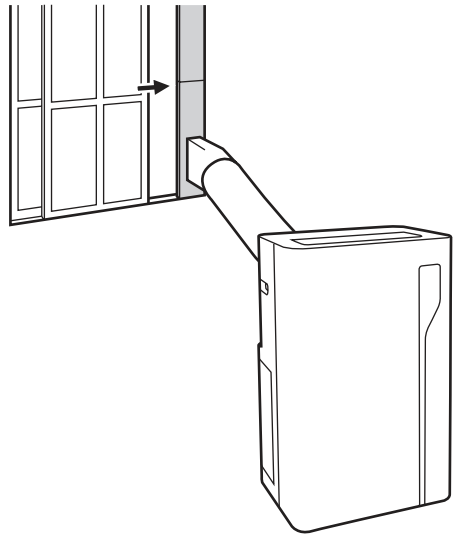
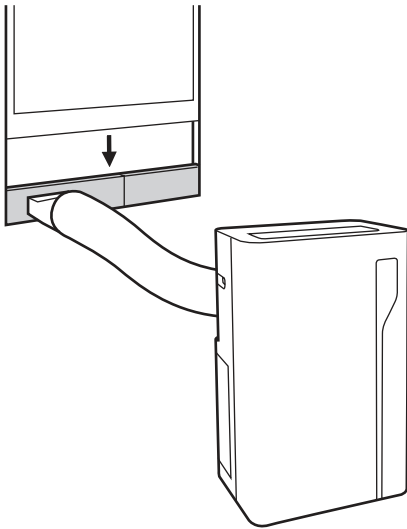
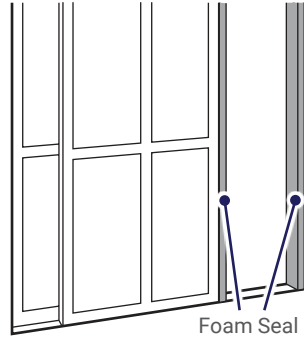

1. Attach foam seal to the window sash and the window frame.
2. Place the window slider kit between the window sash and window frame.



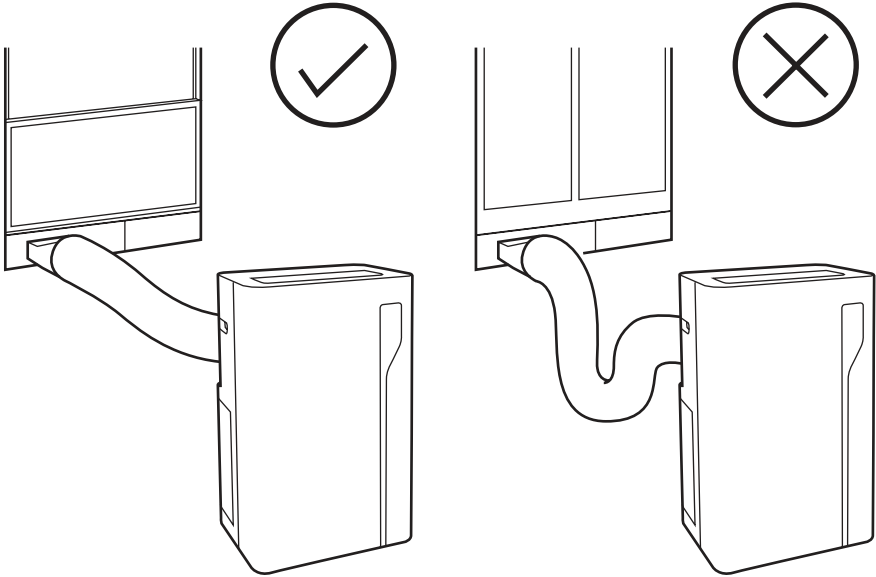



Installation Guide

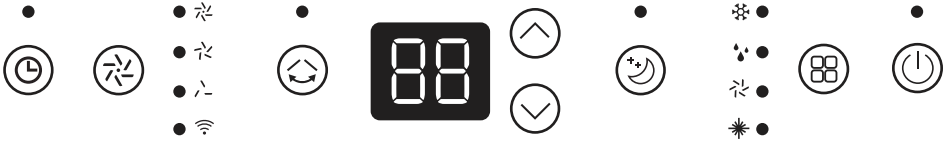

- Exhaust duct should be kept to a minimum length and as straight as possible.
- Stretching or bending the duct excessively will decrease cooling efficiency.

Control Panel



Icon	Button Name	Function
	Power Button	Power ON / OFF the air conditioner ▶ Page 16
	Mode Button	Change the operation mode setting ▶ Page 16, 17
	Sleep Button	Enable sleep mode ▶ Page 19
	Increase / Decrease Button	Adjust temperature / timer / unit setting ▶ Page 16-18
	Oscillation Button	Enable the air outlet to oscillate ▶ Page 17
	Fan Speed Button	Control the fan speed ▶ Page 17
	Timer Button	Enable shut down / turn on timer ▶ Page 18

Remote Control

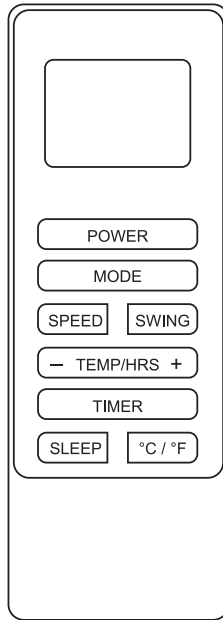

Icon	Button Name	Function
POWER	Power Button	Power ON / OFF the air conditioner ▶ Page 16
MODE	Mode Button	Change the operation mode setting ▶ Page 16, 17
SPEED	Speed Button	Control the fan speed ▶ Page 16, 17
SWING	Swing Button	Enable the air outlet to oscillate ▶ Page 17
- TEMP/HRS +	Increase / Decrease Button	Adjust temperature / timer setting ▶ Page 16-18
TIMER	Timer Button	Enable shut down / turn on timer ▶ Page 18
SLEEP	Sleep Button	Enable sleep mode ▶ Page 19
°C / °F	Unit Button	Changing display unit between °C and °F ▶ Page 18

Remote Control

Changing Remote Control Battery

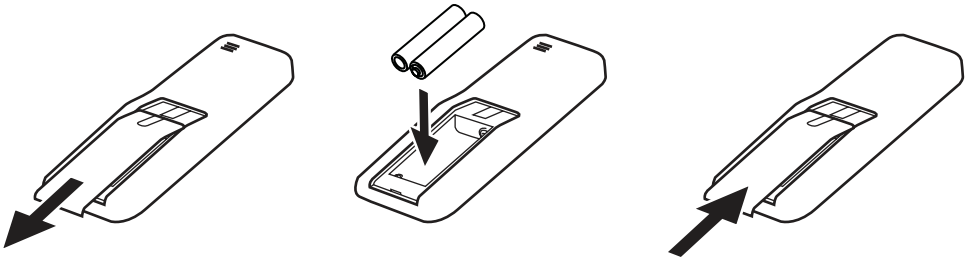



1. Remove the back cover and insert 2 new AAA 1.5v batteries. (not included)
2. Re-install the back cover to the remote control.

WARNING





- Do not use rechargeable batteries.
- Replace the old batteries with new ones of the same type.
- Do not dispose batteries as unsorted municipal waste.

Operation Instructions

Power ON / OFF



1. Press  on the control panel or press **POWER** on the remote control to turn on the unit.
2. Press  on the control panel or press **POWER** on the remote control again to turn off the unit.

Cool Mode

1. Press  on the control panel or **MODE** on the remote control to select cool mode.
 -  indicator will lights up on the control panel.
2. Press   on the control panel or **- +** on the remote control to adjust temperature setting.
 - Temperature can be set from 16°C - 32°C / 61°F - 90°F.
3. Press  on the control panel or **SPEED** on the remote control to adjust fan speed.





Dry Mode

1. Press  on the control panel or **MODE** on the remote control to select dry mode.
 -  indicator will lights up on the control panel.





Operation Instructions

Fan Mode

1. Press  on the control panel or **MODE** on the remote control to select fan mode.
 -  indicator will lights up on the control panel.
2. Press  on the control panel or **SPEED** on the remote control to adjust fan speed.





Heat Mode

1. Press  on the control panel or **MODE** on the remote control to select cool mode.
 -  indicator will lights up on the control panel.
2. Press   on the control panel or **- +** on the remote control to adjust temperature setting. Temperature can be set from 61°F - 90°F.
3. Press  on the control panel or **SPEED** on the remote control to adjust fan speed.





Oscillation Function



1. Press  on the control panel or **SWING** on the remote control to enable vent oscillation.
 - The vents on the air conditioner will osciallate side to side.
2. Press  on the control panel or **SWING** on the remote control again disable vent oscillation.

Operation Instructions

Turn ON Timer

1. Make sure the air conditioner is OFF.
2. Press  on the control panel or **TIMER** on the remote control to begin setting turn on timer.
3. Press   on the control panel or **- +** on the remote control to set the desired time.
4. Leave the setting for 5 seconds, the air conditioner will start the timer automatically.
5. Set the timer to 00 or manually turn ON the unit to cancel the timer setting.

Shut OFF Timer

1. Make sure the air conditioner is ON.
2. Press  on the control panel or **TIMER** on the remote control to begin setting shut off timer.
3. Press   on the control panel or **- +** on the remote control to set the desired time.
4. Leave the setting for 5 seconds, the air conditioner will start the timer automatically.
5. Set the timer to 00 or manually turn OFF the unit to cancel the timer setting.

Changing Temperature Unit

1. Press **°C / °F** on the remote control to change temperature unit between degree Celsius and degree Fahrenheit.

Operation Instructions

Sleep Mode

1. Press  on the control panel or **SLEEP** on the remote control to enable sleep mode.

- In cool mode, the air conditioner will increase temperature by 2°F after 1 hour, and then another 2°F after the 2nd hour. Then the air conditioner will keep the temperature constant for 10 hours.

- In heat mode, the air conditioner will decrease temperature by 2°F after 1 hour, and then another 2°F after the 2nd hour. Then the air conditioner will keep the temperature constant for 10 hours.

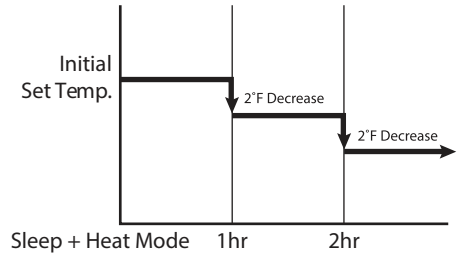
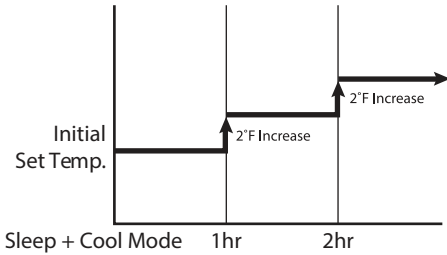

Operation Instructions

Automatic Defrost

At low room temperature, frost may build up at the evaporator during operation. The unit will automatically start defrosting and the power indicator will blink. The defrost control sequence is as follows:

- When the unit operates in cooling or drying mode, and the ambient temperature sensor detects the evaporator coil temperature is below 30°F, the compressor will stop operating for 10 minutes or with the coil temperature raises up to 44°F. After that, the unit will restart cool mode operation.
- When the unit operates in dry mode, once the coil temperature sensor detect the temperature of the evaporator is below 104°F and rthe differential temperature between coil temperature and room temperature is below 66°F after the compressor operation for 20 minutes, the unit start defrosting for 5 minutes and the power indicator blinks.

Overload Protection

In the event of power lost, there is a 3 minutes delay to protect the compressor before it restarts.

Operation Instructions

Grounding

This product must be properly grounded. If it should malfunction or breakdown, grounding provides a path of least resistance for electric current to reduce the risk of electric shock.

For additional safety, the power cord features an integrated circuit breaker. Test and reset the buttons provided on the plug.

The circuit breaker should be tested periodically by pressing the TEST button. If it does not cause the circuit breaker to trip or if the RESET button will not stay engaged, unplug the unit immediately and contact your service technician.

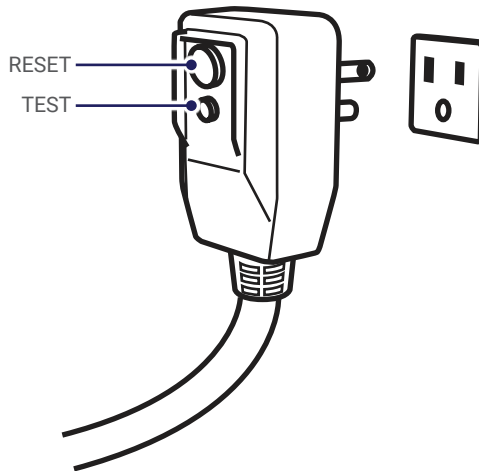

WARNING

- Improper connection can result in a risk of electric shock. Check with a qualified electrician or serviceman if you are in doubt as to whether the product is properly grounded.
- Do not modify the plug provided with the product.

Operation Instructions

Water Drainage

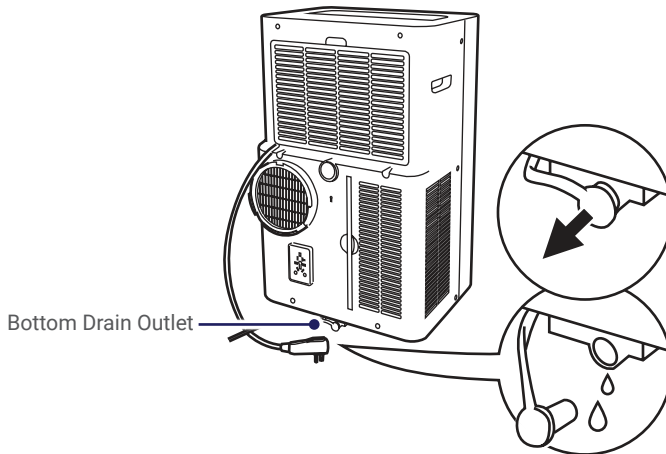

- When the internal water tank is full the digital display will show "FL" error code.
- Carefully move the air conditioner to a drain location, then remove the bottom drain plug and drain the water.
- After draining, re-install the drain plug and restart the air conditioner.

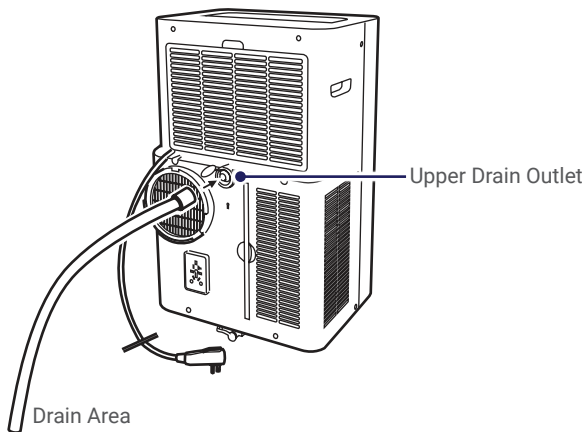

- For continue drainage during dry mode, remove the upper drain plug and insert a drain hose to the outlet.
- Place the other end of the hose to a drain area.

Attention

- Do not submerge the end of the hose into water to prevent air lock.

Care and Maintenance

⚠ CAUTION

- Before cleaning the unit, you must shut down the machine and cut off the power supply.
- Never flush the air conditioner with water.

Clean the Unit

1. Clean the heater with a soft dry cloth or a dampened cloth with neutral detergent.

NOTE:

- Do not flush the machine with water.
- Do not use volatile liquids such as thinner or alcohol to prevent damaging the unit.

Clean the Air Filter

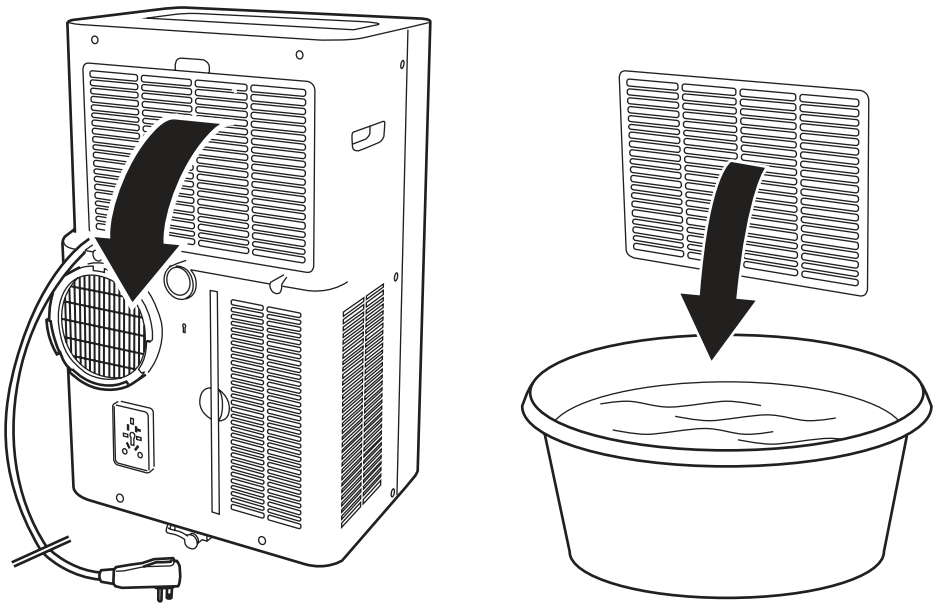

1. Remove the air filters from the air conditioner.
2. Clean the air filters with vacuum cleaner or with warm water with mild neutral detergent.
3. Make sure air filters are dry and then re-install it to the air conditioner.

Care and Maintenance

Storage

If you will not be using the unit for an extended period of time, it is best to clean and dry out the unit completely.

1. Unplug the unit from power outlet and detach exhaust hose and window sliding kit from the unit.
2. Drain the remaining water from the unit.
3. Clean and dry the air filter.
4. Re-install the cleaned air filter at its position.
5. Store the unit in a dry indoor location. The unit must be kept in upright position.

Attention

- The evaporator of the unit must be dried out before storage to prevent molds by leaving the machine in a dry open area or turn on the machine with low speed fan mode.

Troubleshooting

Problem	Possible Causes
The appliance is nonoperational	Power failure / plug pulled out
	Power breaker tripped
	Full water tank
	Outside of operation temperature
The appliance is working in reduced capacity	Obstruction on the vent
	Dirty air filter
	Room is too big / window and / or door are open
	Exhaust hose is not properly attached
Water Leak	Full water tank
Noise or Vibration	The appliance is placed on uneven ground

Error Code

Code	Meaning
00 / E0	Communication fault between main PCB and display PCB
E1	Ambient temperature sensor failure
E2	Coil temperature sensor failure
Ft	Full water Tank

Disposal Guideline

This appliance contains refrigerant and other potentially hazardous materials. When disposing of the appliance, follow all federal, state and local regulations. **DO NOT** dispose of this product as normal household waste or unsorted municipal waste.

When disposing of this appliance, you have the following options:

- Dispose of this appliance at a designated municipal electronic waste collection facility.
- When buying a new appliance, the retailer will take the old appliance.
- The manufacturer may take back the old appliance.
- Sell the appliance to a certified scrap metal dealer.



Model: 048-OPAC-9H

ID: 2ANDL-WBR3

FCC Caution

This device complies with part 15 of the FCC rules. Operation is subject to the following two conditions:

(1) This device may not cause harmful interference, and (2) this device must accept any interference received, including interference that may cause undesired operation.

Any changes or modifications not expressly approved by the party responsible for compliance could void the user's authority to operate the equipment.

NOTE: This equipment has been tested and found to comply with the limits for a Class B digital device, pursuant to part 15 of the FCC Rules. These limits are designed to provide reasonable protection against harmful interference in a residential installation. This equipment generates users and can radiate radio frequency energy and, if not installed and used in accordance with the instructions, may cause harmful interference to radio communications, However, there is no garentee that interference will not occur in a particular installation. If this equipment does cause harmful interference to a radio or television reception, which can be determined by turning the equipment off and on, the user is encouraged to try to correct the interference by one or more of the following measures:

- Reorient or relocate the receiving antenna.
- Increase the seperation between the equipment and receiver.
- Connect the equipment into an outlet on a circuit different from that to which the receiver is connected.
- Consult the dealer or an experienced radio / TV technician for help.

IC Warning

This device complies with industry Canada's license-exempt RSSs. Operation is subject to the following two conditions:

(1) This device may not cause interference; and

(2) This device must accept any interference, including interference that may cause undesired operation of the device.



www.dellahome.com

manufacturer@dellahome.com

800-863-4143

6:00a.m. – 4:00p.m. PST Monday - Friday

©Della All rights reserved.

Under the copyright law, this document may not be printed, translated, reproduced, or distributed, in whole or in part without written permission from DELLA.

Every effort has been made to ensure that the information in this document is accurate, DELLA is not responsible for printing or clerical errors.

All trademarks, logos, and brand names are the property of their respective companies. Mention of third-party products or service names is for identification and informational purposes only. Use of these names, brands, and trademarks does not imply endorsement. DELLA assumes no responsibility with regard to the performance or use of these products.