

048-TL-18K-MODU  
048-TL-27K-MODU  
048-TL-36K-MODU

DELLA



# Operations Manual

Learn how to use and maintain this appliance  
and troubleshoot.



# Contents

Warning and Safety -----	04
Product Specification -----	06
Parts Details -----	08
Remote Control -----	09
Operation Instructions -----	12
Wi-fi / App Connection -----	25
Care and Maintenance -----	31
Troubleshooting -----	33
Disposal Guideline -----	35

# Warning and Safety

\*Read this guide before installation. Failure to follow the safety instructions may result in property damage, serious injury or death.

## DANGER

Indicates an **imminently** hazardous situation that, if not avoided, will result in death, serious injury, or serious property damage.

## WARNING

Indicates a **potentially** hazardous situation that, if not avoided, will result in death, serious injury, or serious property damage.

## CAUTION

Indicates a **potentially** hazardous situation that, if not avoided, will result in minor to moderate injury. It may also be used to indicate unsafe practice.

## DANGER

- In the case of the appliance emitting smoke or burning smell, shut down the appliance and disconnect from the power supply immediately.
- In the case of refrigerant leakage, shut down the appliance and disconnect from the power supply. Contact a qualified technician for inspection. Refrigerant can be toxic and flammable. Rapid evaporation of refrigerant may cause frostbite, cardiac arrhythmia, and/or skin irritation.

## WARNING

- Cleaning and maintenance should be carried out by a specialized technician. The appliance must be off and disconnected from the power supply before carrying out any maintenance.
- Do not disconnect the appliance from the power supply before shutting off the appliance. This might create a spark and potentially cause a fire.
- Repairs should be carried out by a professional or qualified technician only. Incorrect repair could expose the user to potential electric shock or other kinds of hazards.
- Do not place flammable substances such as alcohol, etc. Or of pressurized containers such as spray cans, or any other heat source near the appliance.
- Do not climb onto or place any objects on the appliance.
- Do not insert any objects into the appliance to prevent damage or injury.

# Warning and Safety

## CAUTION

- If the appliance is used in areas without the possibility of ventilation, precautions must be taken to prevent any leaks of refrigerant.
- Only use the appliance as instructed in this booklet. These instructions are not intended to cover every possible condition and situation. As with any electrical household appliance, common sense and caution are therefore always recommended for usage and maintenance.
- This appliance is designed and made for air conditioning in domestic environments only. It must not be used for any other purpose such as drying clothes or cooling foods.
- This appliance can be used by children 8 years old and above and persons with reduced physical, sensory, or mental capabilities, or lack of experience and knowledge if they have been given supervision or instruction concerning the use of the appliance in a safe way and understand the hazard involved.
- Children shall not play with the appliance.
- Always use the appliance with an air filter. Using the appliance without an air filter would lead to dust or waste accumulation or inner parts failure.
- Emptied remote control batteries must be recycled or disposed of properly.
- Do not touch the appliance when barefoot or parts of the body are wet or damp.
- Do not obstruct the air inlet or outlet.

# Product Specification

Model		048-TL-18K-MODU	048-TL-27K-MODU
Power Supply		208V - 230V / 60Hz / 1P	208V - 230V / 60Hz / 1P
Rated Cooling Capacity (Btu / h)		18000	27000
Rated Heating Capacity (BTu / h)		20000	27000
Rated Input Consumption	Cooling	1350W	1860W
	Heating	1600W	1950W
Rated Current	Cooling	6.5A	8.8A
	Heating	7.2A	9.1A
Refrigerant		R410A	R410A
Outdoor noise level		56 dBA	58 dBA
Outdoor unit Net Dimension (W x D x H)		845 x 380 x 699 (mm) / 33.27" x 14.97" x 27.52"	900 x 360 x 805 (mm) / 35.43" x 14.17" x 31.69"
Outdoor unit Net Weight		44.0kg / 97.0lb	56.0kg / 123.5lb

# Product Specification

<b>048-TL-36K-MODU</b>
208 V - 230 V / 60 Hz / 1P
36000
36000
2600W
2890W
11.8A
13.1A
R410A
63 dBA
1005 x 400 x 910 (mm) / 35.43" x 14.17" x 31.69"
75.5kg / 166.4lb

# Parts Details

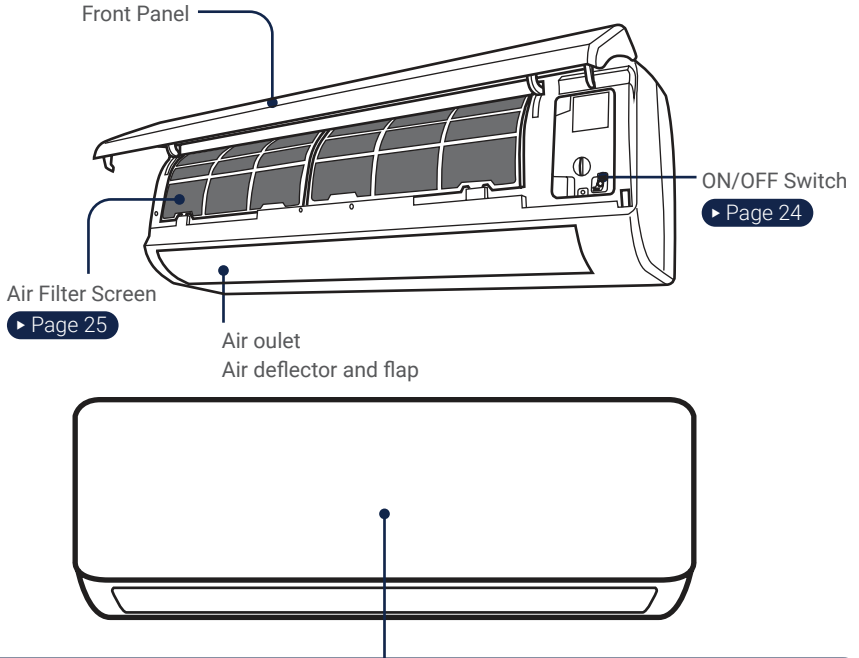

Display

LED Indicator	Function
88	Indicator for timer, temperature, and error codes
⏰ ⌚	Lights up when timer is enabled
🌙	Lights up when SLEEP mode is enabled
🌀	Lights up when the unit is turned on
⏻	Lights up when the unit is powered

NOTE:  
 • The graphical representation might have slight differences than the actual product.

# Remote Control

## Front of Remote Control

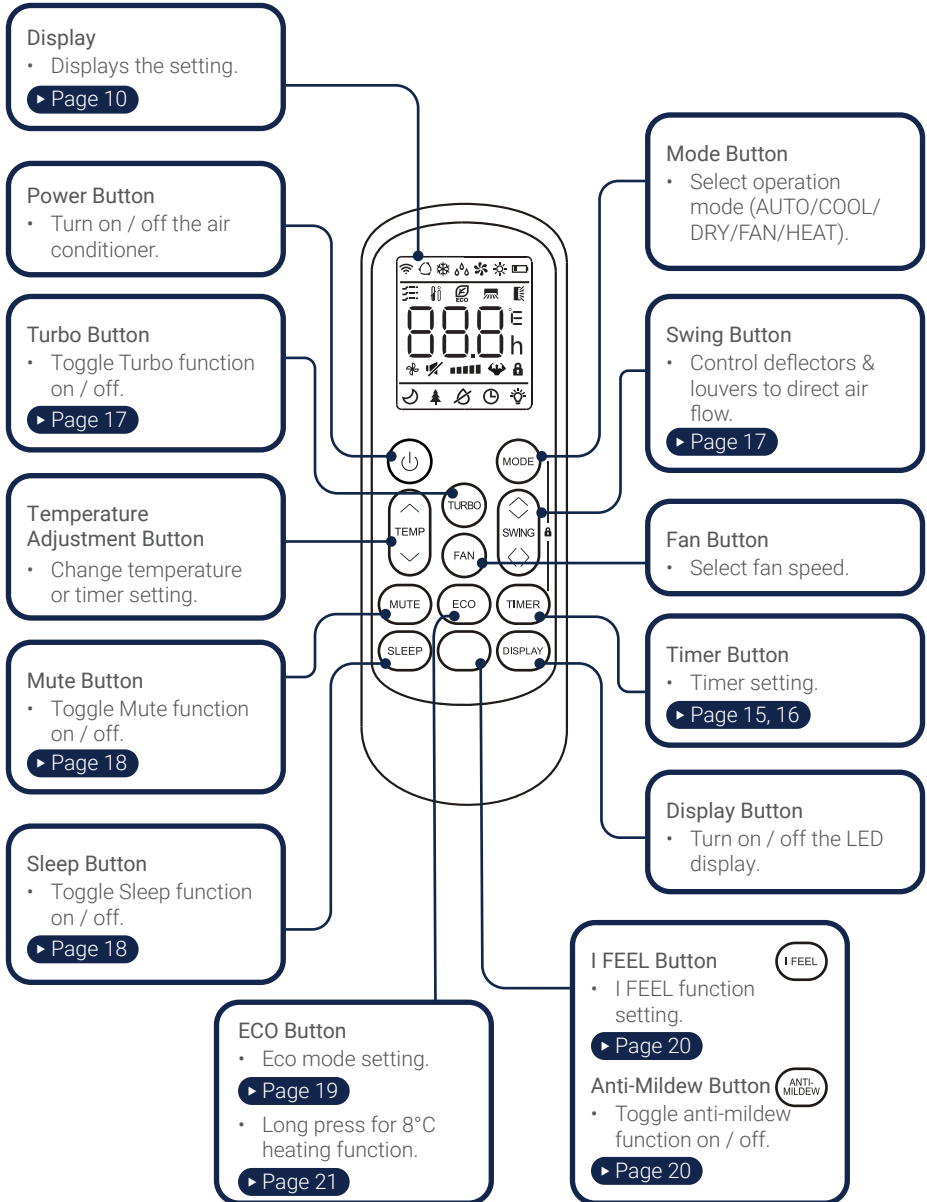

### NOTE:

- Appearance of the display and function of the remote control might differ from some models.
- The shape and position of buttons and indicator of the remote control might differ from some models.

# Remote Control

## Remote Control Display



Indicator	Function	Indicator	Function
	Signal Indicator		Horizontal Louvers Indicator
	Auto Mode		Temperature Indicator
	Cool Mode		Fan Speed Indicator
	Dry Mode		Mute Mode
	Fan only Mode		TURBO Mode
	Heat Mode		Child Lock
	Battery Indicator		Sleep Mode
	Gentle Wind Mode		Health Mode
	I FEEL Mode		Anti-Mildew
	ECO Mode		Timer
	Vertical Deflectors Indicator		Display ON/OFF Indicator

NOTE:

- Appearance of the display and function of the remote control may differ from some models.
- Some models may not have all the function listed above.

# Remote Control

## Back of Remote Control

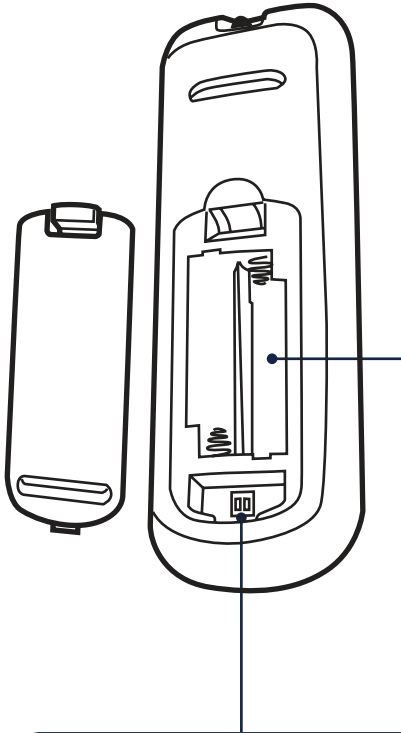

### To set or replace batteries.

1. Remove the back cover from the remote control.
2. Insert 2 LR03 AAA 1.5V batteries.
3. Reinstall the back cover.

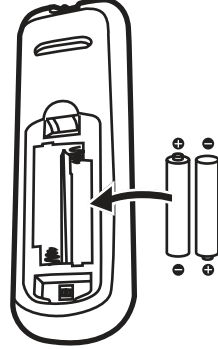

### ⚠ Attention

- Do not use rechargeable batteries.
- Replace the old batteries with new ones of the same type.
- Do not dispose batteries as unsorted municipal waste.

### Unit Adjustment (°C/°F)

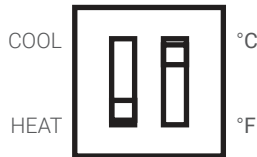

DIP Switch position	Function
°C	The display is adjusted in degree celsius
°F	The display is adjusted in degree fahrenheit
COOL	The display is adjusted in cooling mode <b>ONLY</b>
HEAT	The display is adjusted in both cooling and heating mode

# Operation Instructions

## Cooling Mode

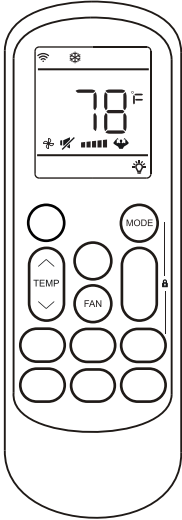

The cool function allows the air conditioner to cool the room and reduce humidity.

1. Press **MODE** and select COOL function.
  - ❄️ is displayed on the display.



2. Press **TEMP** to set a temperature lower than the room temperature.

3. Press **FAN** to change the air flow.



## Fan Mode and Fan Speed

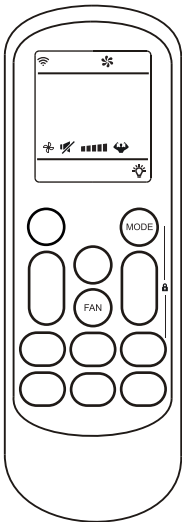

Fan function circulates and ventilates air in the room.

1. Press **MODE** and select FAN function.
  - 🌀 is displayed on the display.



2. Press **FAN** to change the operating fan speed.



# Operation Instructions

## Dry Mode

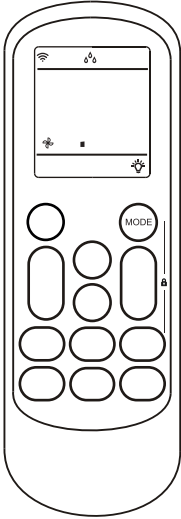

Dry mode allows the air conditioner to reduce the humidity of the air and make the room more comfortable.

1. Press **MODE** and select DRY function.

-  is displayed on the display.



## Auto Mode

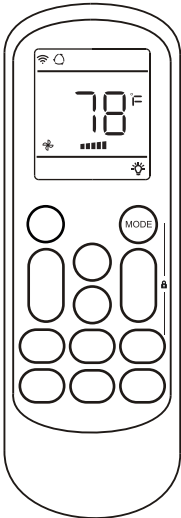

The auto function allows the air conditioner to automatically adjust the room's temperature according to the programmed auto mode temperature.

1. Press **MODE** and select AUTO function.

-  is displayed on the display.



# Operation Instructions

## Heating Mode

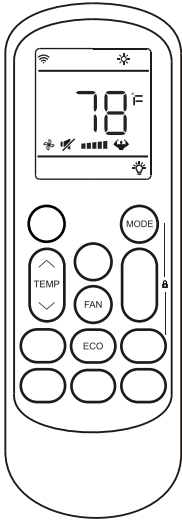

The heat function allows the air conditioner to warm up the room.

1. Press  and select HEAT function.



2. Press  to set a temperature higher than the room temperature.

3. Press  to change the air flow.



### NOTE:

- During HEATING operation, the appliance can automatically activate defrost cycle, which is essential to remove frost on the condenser for heat exchange function. This procedure usually last for 2 - 10 minutes. During defrosting, indoor unit fan will stop operating. Once the defrosting is completed, it will resume the HEATING mode automatically.
- The indoor unit will take 2 - 5 minutes of preheating before the unit starts blowing warm air.
- (For North American Market)  
If necessary, press  10 times within 8 seconds under HEAT function to start forced defrosting. The unit will speed up the outdoor defrosting.

# Operation Instructions

## Timer

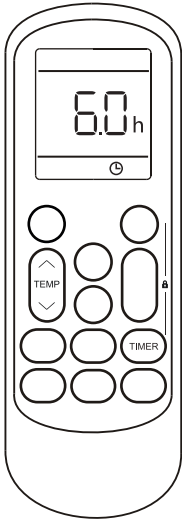

### Setting ON Timer

Set a timer to automatically switch ON the air conditioner.

1. Turn off the unit.
2. Press **TIMER** once to set switch on timer.  
- and **6.0 h** are displayed on the remote display and flashes.
3. Press **TEMP** to set desired switch on time.  
- The timer increases by half an hour between 0 - 10 hours and one hour between 10 - 24 hours.
4. Press **TIMER** again to confirm the timer setting.
5. After setting the ON timer, press **MODE** and **FAN** to set desired mode and fan speed.
6. Press **TEMP** to set desired operation temperature.

#### NOTE:

- While entering the programming, make sure each button press is within 5 seconds, otherwise, the entire process will reset and you'll have to start over.

### Cancel ON Timer

1. Press **TIMER** again cancel the ON timer.

# Operation Instructions

## Timer

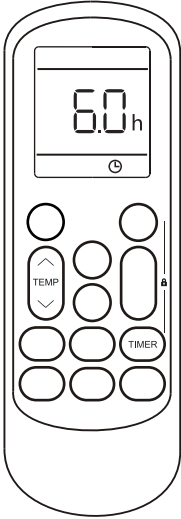

### Setting OFF Timer

Set a timer to automatically switch OFF the air conditioner.

1. Press **TIMER** once to set switch off timer.  
- and **6.0h** are displayed on the remote display and flashes.
2. Press **TEMP** to set desired switch off time.
3. Press **TIMER** again to confirm the timer setting.

NOTE:

- While entering the programming, make sure each button press is within 5 seconds, otherwise, the entire process will reset and you'll have to start over.

### Cancel OFF Timer

1. Press **TIMER** again cancel the OFF timer.

## Child Lock

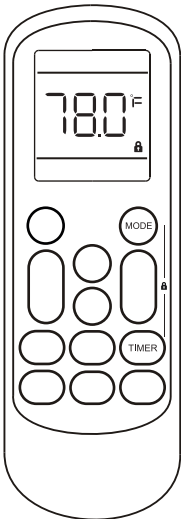

Child lock function will disable all input from the remote control until unlocked.

1. Press **MODE** and **TIMER** to activate child lock.  
- is displayed on the display
2. Press **MODE** and **TIMER** again to deactivate child lock.

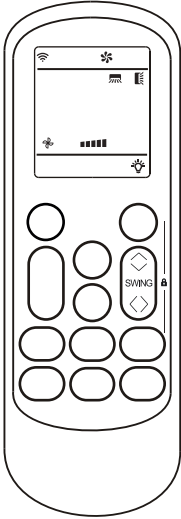

# Operation Instructions

## Adjusting Air Flow





### Adjusting up and down airflow

Adjust horizontal louvers.

1. Press  once to activate the horizontal louvers.
  -  is displayed on the display and louvers will begin to swing.
2. Press  to set desired position.

### Adjusting left and right airflow

Adjust vertical deflectors.

1. Press  once to activate the vertical deflectors.
  -  is displayed on the display and deflectors will begin to swing.
2. Press  to set desired position.



NOTE:

- Never manually adjust the louvers or the deflectors. Attempt to move it by hand may damage the moving mechanism.

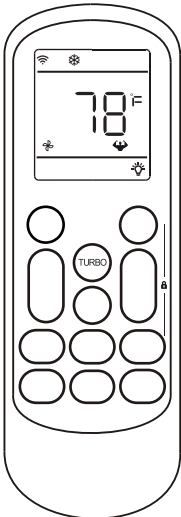
## Turbo Function



Turbo function will speed up cooling or heating and blow the maximum flow of air.

1. Press  to activate turbo function.
  -  is displayed on the display.
2. Press  again to deactivate turbo function.

# Operation Instructions

## Mute Function

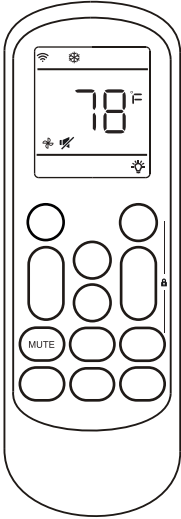

The air conditioner will operate at the quietest setting under mute function.

1. Press **MUTE** once to activate MUTE function.  
-  is displayed on the display and the indoor unit will operate at the lowest fan speed.
2. Press **MUTE** again or press **TURBO** or **SLEEP** to disable MUTE function.

## Sleep Function

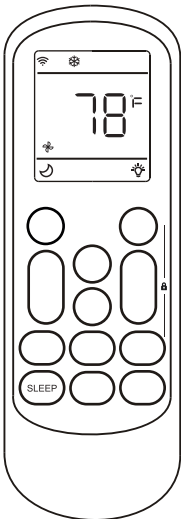

Sleep function is a pre-set automatic operating program which is suitable during sleep time.

1. Press **SLEEP** once to activate SLEEP function.  
-  is displayed on the display, and the air conditioner will operate under sleep function for 10 hours before changing back to the previous setting mode.
2. Press **SLEEP** again to disable sleep function.

# Operation Instructions

## Eco Function

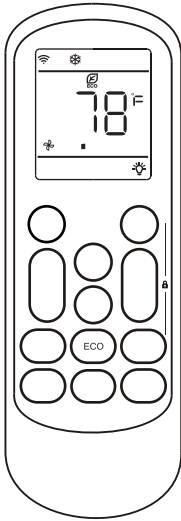

The air conditioner will automatically set the operation to save energy.

1. Press **ECO** once to activate ECO function.
  -  is displayed on the display.
2. Press **ECO** again to disable ECO function.

NOTE:

- ECO function is available in both COOL and HEAT mode.

## Display Function

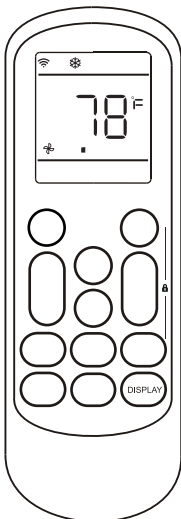

Switch ON / OFF the LED display on the indoor unit front panel.

1. Press **DISPLAY** once to turn off the indoor unit display.
  -  is turned off on the remote control display.
2. Press **DISPLAY** again to turn on the display.

# Operation Instructions

## I FEEL Function (Available only for models with I FEEL button)

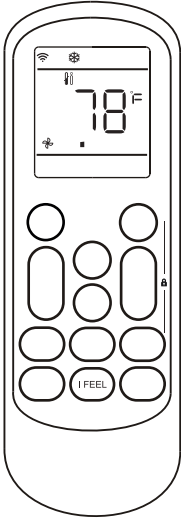

I FEEL function turns your remote control into a portable thermostat that automatically controls the unit to adjust the temperature of the room you are in.

1. Press **I FEEL** once to activate I FEEL function.  
-  is displayed on the display.
2. Press **I FEEL** again to disable I FEEL function.

NOTE:

- I FEEL function will automatically deactivate after 2 hours.

## Anti-Mildew Function (Available only for models with Anti-Mildew button)

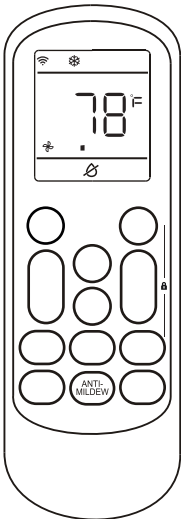

The air-conditioner will try to dry the indoor unit to prevent mildew.

1. Press **ANTI-MILDEW** once to activate Anti-Mildew function.  
-  is displayed on the display, and the unit will blow airflow for about 15 minutes and then shut off the unit
2. Press **ANTI-MILDEW** again to disable Anti-Mildew function.

NOTE:



- Anti-Mildew function is only available after running COOL or DRY mode for more than 30 minutes.

# Operation Instructions

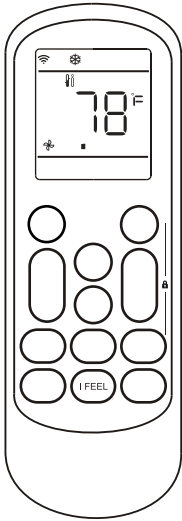
## Self-clean Function (Available only for certain heat pump inverter models)



This function helps carry away the accumulated dirt, bacteria, etc. from the indoor evaporator.

1. Press  and  at the same time toward the indoor unit.
  - You will hear a “beep” sound from the indoor unit.
  - **RC** is displayed on the display.
  - The self-cleaning function will run for about 30 minutes, then it will return to the previous mode.
2. You can press  to cancel this function during the process.
  - You will hear “beep- beep” when the process is finished or cancelled.



### NOTE:

- It is normal that the unit makes some noise during self-cleaning process as plastic materials expand and contract with temperature change.
- It is recommended to operate this function when the indoor ambient temperature is under 86°F / 30°C, and the outdoor ambient temperature between 41°F to 86°F / 5°C to 30°C.
- It is suggested to run the self-cleaning function every 3 months.

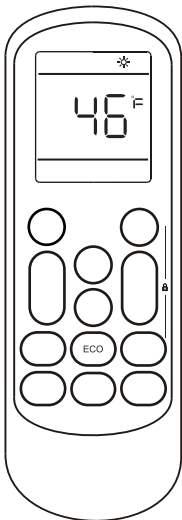
## 8°C Heating Function



This function automatically starts HEAT mode when the room temperature is lower than 46°F or 8°C.

1. Press  and hold 3 seconds to activate this function.
  - **46 F** or **8 C** is displayed on the display.
  - The function will return into stand by when the room temperature reaches 48°F or 9°C.
  - The appliance will automatically cancel this function when room temperature is higher than 64°F or 18°C.
2. Press  and hold 3 seconds to deactivate this function.

# Operation Instructions

## Gentle Wind Function

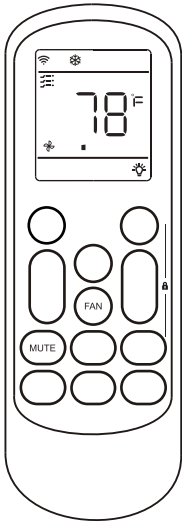

The indoor unit will automatically close the vertical flaps and give you a comfortable gentle airflow.

1. Press **MUTE** and **FAN** for 3 seconds to activate gentle wind function.  
-  is displayed on the display.
2. Press **MUTE** and **FAN** for 3 seconds to deactivate gentle wind function.

## Health Function

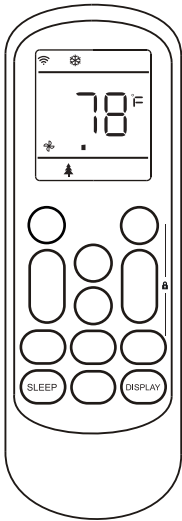

This function will activate the Ionizer / Plasma / Bipolar Ionizer / UVC lights inside the unit.

1. Press **SLEEP** and **DISPLAY** for 3 seconds to activate health function.  
-  is displayed on the display.
2. Press **SLEEP** and **DISPLAY** for 3 seconds to deactivate health function.

# Operation Instructions

## Ambient Temperature

You can safely use the air conditioner in the following ambient temperature conditions.

	HEAT Mode	COOL Mode	DRY Mode
Ambient Room Temperature	32°F - 80°F / -0°C - 27°C	62°F - 86°F / 17°C - 30°C	
Outdoor Temperature	5°F - 75°F / -15°C - 24°C  Low Temperature Heating: -4°F - 75°F / -20°C - 24°C	T1 Climate: 59°F - 122°F / 15°C - 50°C	
		Low Temperature Cooling: 5°F - 122°F / -15°C - 50°C	
		T3 Climate: 59°F - 131°F / 15°C - 55°C	

NOTE:

- Attempting to use the air conditioner beyond the specified temperature range may activate the protection device and cause the air conditioner to stop operating.
- In the case of a tripped protection, shut down the air conditioner and restart, or switch to a different mode during operation. The air conditioner will reset the protection device and the compressor will resume operation after 3 minutes.

## Operating Temperature

You can set the air conditioner temperature within the following range.

	HEAT Mode	COOL Mode	DRY Mode
Operation Temperature Setting	61°F - 88°F / 16°C - 31°C		

NOTE:

- Avoid prolonged exposure to cold air, especially to children, elderly, or medical patients.

# Operation Instructions

## Emergency Button

You can use the emergency button for limited control of the air conditioner in case the remote control fails or is missing.

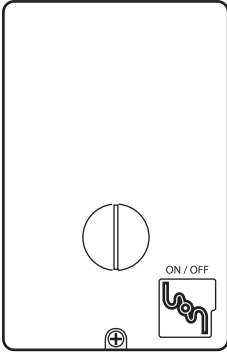
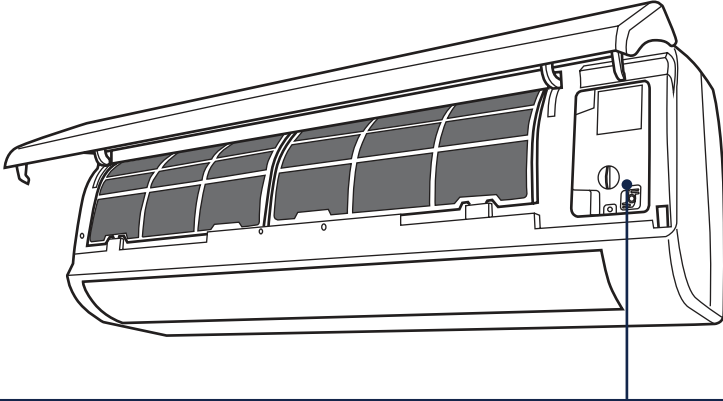

### Indoor unit ON/OFF switch

- In stand by mode, press this switch ONCE to start cooling mode.  
- You will hear a beep.
- In stand by mode, press this swtich TWICE within 3 seconds to start heating mode.  
- You will hear beep-beep.
- In operation, press this switch ONCE to turn off the unit.  
- You will hear multiple beeps.

#### NOTE:

- Always wear insulation material when pressing the emergency button.

# Wi-fi / App Connection

## Wi-Fi Network



- Make sure you have a working Wi-Fi network.
- Connect your smart-phone to the Wi-Fi network.
- Wi-Fi network must support 2.4 - 2.5GHz, the appliance cannot connect to a 5GHz network.

Wi-Fi Requirement	
Standards of WLAN	IEEE 801.11 b/g/n(channels 1-14)
Protocal Stack Support	IPv4 / IPv6 / TCP / UDP / HTTPS / TLS / MulticaseDNS
Security Support	WEP / WPA / WPA2 / AES128
Network Type Support	STA / AP / STA+AP

## Download the Application



- Search "DELLA+" on app store or google play, or scan the QR code below to download the application.
- Enable permission of storage, location, and camera for this application, otherwise it will have a problem operating.



### NOTE:

- The Della+ application is free; however, data charges may apply when downloading or using the application.
- Every effort has been made to ensure the accuracy of the instruction and graphic representations at the time of producing this user guide. Your application's user interface, icons, and screen may look different from this guide due to updates and development changes.
- Della+ app can be altered without notice for quality improvement and also be deleted depending on the circumstances of manufacturing firms.

# Wi-fi / App Connection

## User Registration



1 Open the DELLA+ app on your smart devices.

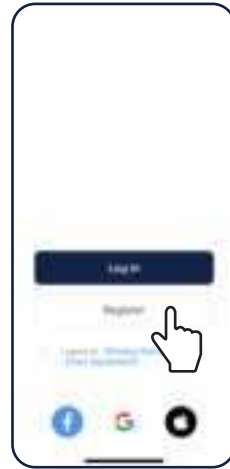

2 Tap the "Register" button for first time user.



3 Tap the country menu.



4 Select your country.



5 Enter your email address, then read and agree to the user agreement, and get verification code.

# Wi-fi / App Connection

## User Registration



- 6 Enter the verification code.



- 7 Set your password and tap "Done".

# Wi-fi / App Connection

## Add Device



1 Tap "Add Device" in the center of the screen or the "+" dropdown menu from the top right corner.



2 Select the appliance type you want to add. Model series can be found on the unit specification label or on the packaging boxes.

Specification Label

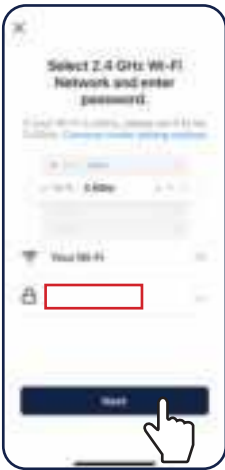

3 Enter your Wi-Fi network password, then tap "Next".

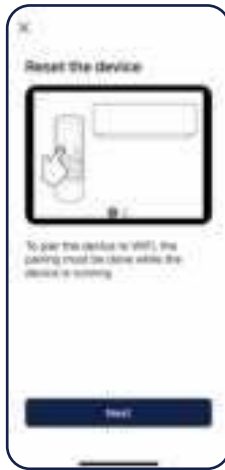

4 Follow the in-app instruction on adding the device.



3 You can see your device on the device list after adding.

# Wi-fi / App Connection

## Basic Control

The basic function of the application interface mimics to that of the remote control.

NOTE:

- Some functions may not be available on the application.



NOTE:

- Appearance of the display and function of the application might differ.
- The shape and position of buttons and indicator of the user interface might differ.

# Wi-fi / App Connection

## Scene



- 1 Tap "Create Scene" in the center of the screen or the "+" dropdown menu from the top right corner.

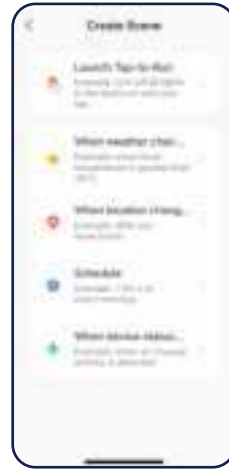

- 2 Customize your unique user experience.

"Scene" function allows you to program your air conditioner to turn on / off depending on your location, and set automated features.

# Care and Maintenance

## ⚠ CAUTION

- Before cleaning the unit, you must shut down the machine and cut off the power supply for at least 5 minutes.
- Never flush the air conditioner with water.

### Clean the Unit

1. Clean the air conditioner with a soft dry cloth or a dampened cloth with neutral detergent.

NOTE:

- Do not flush the machine with water.
- Do not use volatile liquid such as thinner or alcohol to prevent damaging the unit.



### Clean the Air Filter

1. Open the front panel.
2. Pull down the air filter.
3. Clean the air filter with soapy water.
4. Air dry the air filter
5. Put the air filter back to its original place after it is dry.

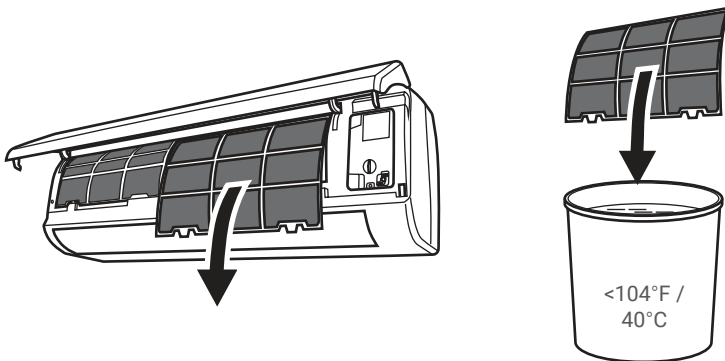

NOTE:

- Do not touch the fins inside the indoor unit with bare hands after removing the filter screen.
- Check and clean the air filter regularly to prevent dust accumulation.
- Clean the air filter frequently if the operating environment is dusty or has bad air quality.

# Care and Maintenance

## Maintenance Routine

- Clean the air filter screen every 3 months.
- Call your HVAC technician to check on the refrigerant level every 3 to 4 years.
- Regularly check and remove any obstacles from the outdoor unit.

## Planning to not operate the air conditioner for a long period

1. Take out the batteries from the remote control and disconnect the power supply of the air conditioner.

## When Using the Air Conditioner After a Long Idle Period

1. Clean the unit and the air filter screen.
2. Remove any obstacles at the air inlet and outlet of both the indoor and outdoor unit.
3. Make sure the drain pipe is unobstructed.
4. Install batteries into the remote control and connect the power supply to the air conditioner.

# Troubleshooting

Problem	Possible Causes
The appliance is non operational	Power failure / plug pulled out
	Damaged indoor or outdoor unit fan motor
	Faulty compressor thermomagnetic circuit breaker
	Faulty protective device or fuses
	Loose Connection
	Internal protection tripped
	Outlet voltage does not match to that of the appliance
	The unit is currently in ON-TIMER mode
	Damaged electronic control board
Strange Odor	Dirty air filter
Noise of running water	Backflow of liquid in the refrigerant circulation
A fine mist comes from the air outlet	This occurs when the air in the room becomes cold in COOL or DRY modes
Strange noise	The noise made by thermal expansion of the front panel due to temperature is normal and does not indicate a problem
Insufficient airflow, either hot or cold	Unsuitable temperature setting
	Obstructed air conditioner intakes and outlets
	Dirty air filter
	Fan speed is set at minimum
	Other sources of heat in the room
The appliance does not respond to commands	Insufficient refrigerant levels
	Remote Control is too far away from the indoor unit
	The batteries of the remote control need to be replaced
	Obstacles between the indoor unit and the remote control

# Troubleshooting

Problem	Possible Causes
The display is off	DISPLAY toggle is set to off
	Power failure

Switch off the air conditioner immediately and cut off the power supply in the event of:

- Strange noises during operation.
- Faulty electronic control board.
- Faulty fuses or switches.
- Spraying water or objects inside the appliance.
- Overheated cables or plugs.
- Very strong smells coming from the appliance.

## Error Codes

In case of an error, the indoor unit display will show the following error codes:

Display	Description
E1	Indoor room temperature sensor fault
E2	Indoor pipe temperature sensor fault
E3	Outdoor pipe temperature sensor fault
E4	Refrigerant system leakage or fault
E6	Malfunction of indoor fan motor
E7	Outdoor ambient temperature sensor fault
E0	Indoor and outdoor communication fault
E8	Outdoor discharge temperature sensor fault
E9	Outdoor IPM module fault
EA	Outdoor current detect fault
EE	Outdoor PCB EEPROM fault
EF	Outdoor fan motor fault
EH	Outdoor suction temperature sensor fault

Contact a professional HVAC technician for further assistance.

# Disposal Guideline

This appliance contains refrigerant and other potentially hazardous materials. When disposing of the appliance, follow all federal, state, and local regulations. **DO NOT** dispose of this product as normal household waste or unsorted municipal waste.

When disposing of this appliance, you have the following options:

- Dispose of this appliance at a designated municipal electronic waste collection facility.
- When buying a new appliance, the retailer will take the old appliance.
- The manufacturer may take back the old appliance.
- Sell the appliance to a certified scrap metal dealer.



[www.dellahome.com](http://www.dellahome.com)

[manufacturer@dellahome.com](mailto:manufacturer@dellahome.com)

800-863-4143

6:00a.m. – 4:00p.m. PST Monday - Friday

©Della All rights reserved.

Under the copyright law, this document may not be printed, translated, reproduced, or distribute, in whole or in part without written permission from DELLA.

Every effort has been made to ensure that the information in this document is accurate, DELLA is not responsible for printing or clerical errors.

All trademarks, logo, brand names are the property of their respective companies. Mention of third-party products or service names are for identification and informational purposes only. Use of these names, brands, and trademarks does not imply endorsement. DELLA assumes no responsibility with regard to the performance or use of these products.