

dji POWER 1000 POWER 500

User Manual

v1.0 2024.04

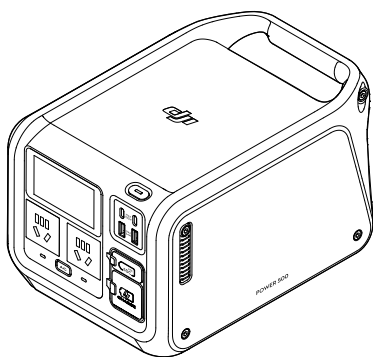

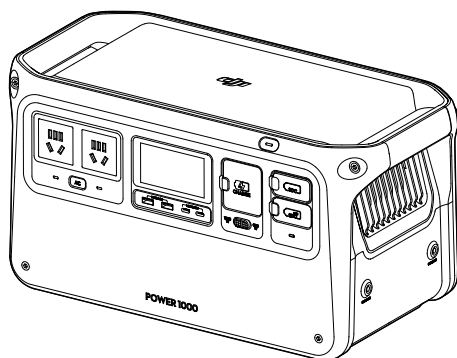

This document is copyrighted by DJI with all rights reserved. Unless otherwise authorized by DJI, you are not eligible to use or allow others to use the document or any part of the document by reproducing, transferring or selling the document. Users should only refer to this document and the content thereof as instructions to operate DJI products. The document should not be used for other purposes.

Searching for Keywords

Search for keywords such as “battery” and “install” to find a topic. If you are using Adobe Acrobat Reader to read this document, press Ctrl+F on Windows or Command+F on Mac to begin a search.

Navigating to a Topic

View a complete list of topics in the table of contents. Click on a topic to navigate to that section.

Printing this Document

This document supports high resolution printing.

Using this Manual

-  • DJI Power 1000 and DJI Power 500 have similar functions and operations. Unless otherwise specified, the descriptions in this document use the DJI Power 1000 as an example and apply to both products.

Legend

 Important

 Hints and Tips

Read Before Use

DJI™ provides users with tutorial videos and the following documents.

1. Safety Guidelines
2. Quick Start Guide
3. User Manual

It is recommended to watch all tutorial videos and read the safety guidelines before using for the first time. Prepare for your first use by reviewing the quick start guide and refer to this user manual for more information.

Tutorial Videos

Go to the address below or scan the QR code to watch the tutorial videos, which demonstrate how to use the product safely.

DJI Power 1000



<https://s.dji.com/guide67>

DJI Power 500



<https://s.dji.com/guide69>

Download DJI Assistant 2

Download DJI ASSISTANT™ 2 (Power Series) at:

<https://www.dji.com/power-1000/downloads> or <https://www.dji.com/power-500/downloads>

Contents

Using this Manual	3
Legend	3
Read Before Use	3
Tutorial Videos	3
Download DJI Assistant 2	3
Introduction	5
Product Profile	5
Display Screen	6
Powering on/off	7
Charging External Devices	8
AC Output	8
USB Output	9
Fast Charging DJI Aircraft Batteries	9
Other SDC Output	10
Recharging the Power Station	11
AC Recharging	11
Solar Recharging	12
Car Recharging	13
USB-C Recharging	13
Uninterruptible Power Supply (UPS)	14
DJI Power 1000 Extensions	15
1/4" Thread Hole	15
Protective Storage Bag	15
Appendix	16
Firmware Update	16
Log Export	17
Troubleshooting	18
Maintenance	18
Accessory Options (Sold Separately)	19
Specifications	21
DJI Power 1000	21
DJI Power 500	22

Introduction

DJI Power 1000 is a portable power station with a capacity of 1024 Wh, a weight of approximately 13 kg, and support for a maximum output power of 2200 W. DJI Power 500 is a portable power station with a capacity of 512 Wh, a weight of approximately 7.3 kg, and support for a maximum output power of 1000 W.

The power stations provide Fast Recharge mode and Standard Recharge mode for AC recharging. In Fast Recharge mode, the power station can be quickly recharged to 80% in approximately 50 minutes, and to 100% in approximately 70 minutes.^[1] In Standard Recharge mode, the operation noise can be reduced and the battery cell life can be extended. And the power station can be recharged to 100% in approximately 2 hours.^[1] The power stations feature SDC/SDC Lite ports. With different DJI Power accessories, the power stations can charge DJI Intelligent Flight Batteries and other types of devices, supporting power supply in various scenarios.

[1] Tested at a room temperature of 25° C (77° F) in a well-ventilated environment and is for reference only.

Product Profile

DJI Power 1000

1. Power Button
2. AC Input Port
3. Display Screen
4. AC Output Ports^[1]
5. AC Output Indicators
6. AC Button
7. USB-A Ports
8. USB-C Ports
9. Recharge Mode Switch
10. SDC Port Indicator
11. SDC Lite Port
12. SDC Port
13. Vents
14. 1/4" Thread Hole

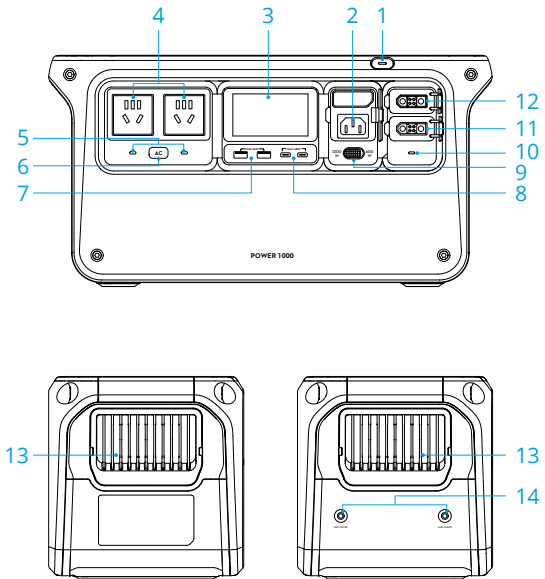

[1] The illustrations in the user manual may differ from the actual product, depending on the country or region. Please refer to the actual product.

DJI Power 500

1. Power Button
2. Display Screen
3. AC Output Ports^[1]
4. AC Output Indicators
5. AC Button
6. AC Input Port
7. Recharge Mode Switch
8. SDC Lite Port
9. USB-A Ports
10. USB-C Ports
11. Vents

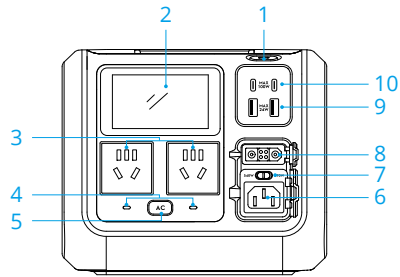

[1] The illustrations in the user manual may differ from the actual product, depending on the country or region. Please refer to the actual product.

Display Screen

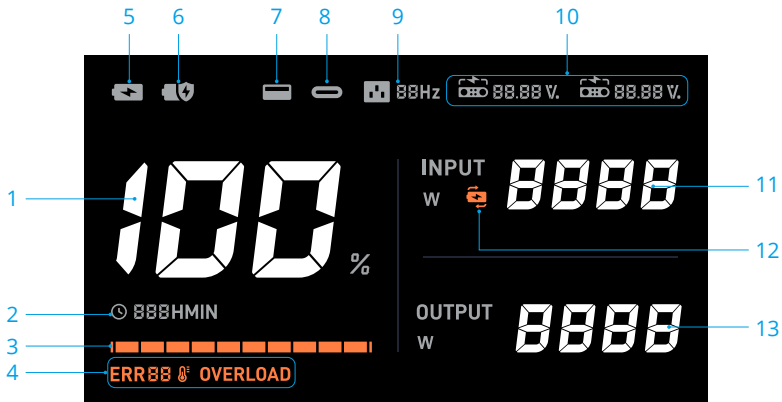

1. Displays current battery level of the power station.
2. Displays the remaining usage time when the power station is charging external devices.
Displays the remaining time required to fully recharge the power station from the current battery level when recharging the power station.
3. **Battery Level Bar:** The battery level bar blinks in sequence when recharging the power station. The last grid of the battery level bar blinks when the power station is charging external devices.





4. System Warnings

ERR88: error code

: Temperature error. When the temperature is abnormal in Fast Recharge mode, the temperature error icon on the display screen blinks slowly. The actual recharge power may be lowered to ensure the battery cell life and safety. The icon will be solid if the temperature is too high or too low. Wait for the temperature to return to normal.

OVERLOAD: overload warning

 • Visit <https://s.dji.com/DJI-Power> to learn about the warning details and the corresponding troubleshooting.

5. : AC recharging in Fast Recharge mode.
6. : AC recharging in Standard Recharge mode.
7. : USB-A port.
8. : USB-C port.
9.  **88Hz**: AC output frequency.
10. **SDC/SDC Lite Port**

: recharging the power station or charging external devices via the SDC/SDC Lite Port.

88.88 V: the voltage value when using the SDC/SDC Lite Port.

88.88 %: the battery level of the intelligent flight battery when charging the battery via the SDC/SDC Lite Port.

11. Input Power

12.  **Uninterruptible Power Supply (UPS)**: if the power station is connected to an AC power outlet and using AC output simultaneously, UPS will be enabled by default. This function is unavailable in some regions. Refer to local laws and regulations for more information.

13. Output Power

Powering on/off

1. **Power on/off**: press and hold the power button for at least two seconds. The display screen will be automatically turned on after powering on.
2. **Turn on/off the display screen**: when the power station is powered on, press the power button once.

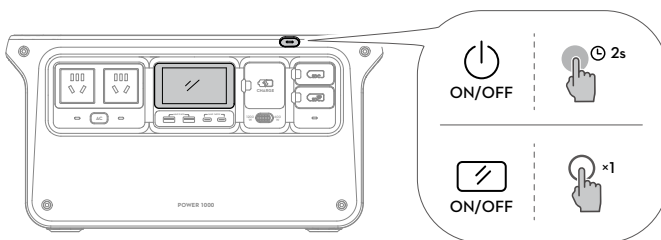

Charging External Devices

AC Output

The power station features two AC output ports. Connect the external device to an AC output port and press the AC Button for AC power supply.

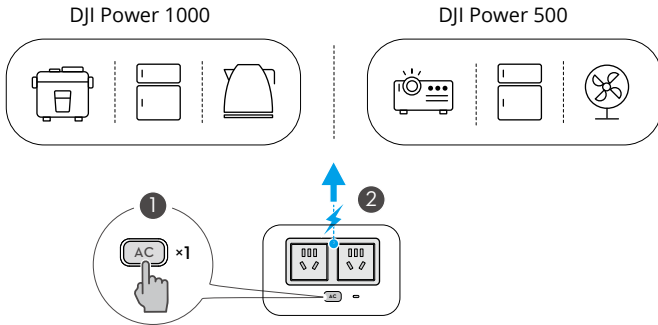

The power station features Automatic AC Shutdown and Auto Shutdown to save power.

- **Automatic AC Shutdown:** press the AC Button once to enable AC output, and the AC output indicator will blink slowly. AC output will automatically shut down to save electricity if the power station is not charging any device via the AC output ports within half an hour.
- **Continuous AC Output:** press and hold the AC Button to enable AC output, the AC output indicator will show solid light, and AC output will not automatically shut down. This can provide a continuous AC power supply to an external device that operates intermittently such as a refrigerator.
- **Auto Shutdown at Low Power Output:** when AC output is disabled, the power station will automatically shut down if it is not charging any device within an hour.

When being recharged with AC input power at different frequencies, the power station will automatically switch to the same frequency as the input power. To manually switch the AC output frequency, disconnect the power station from the AC power outlet when AC output is enabled, then press and hold the AC Button for 10 seconds.

- 💡 • The internal electronic components have a waterproof coating. There may be a faint smell when using a large amount of power. The smell will dissipate naturally with daily use.

USB Output

The power station features two USB-A ports and two USB-C ports. Connect the external device to the USB-A or the USB-C ports for power supply.

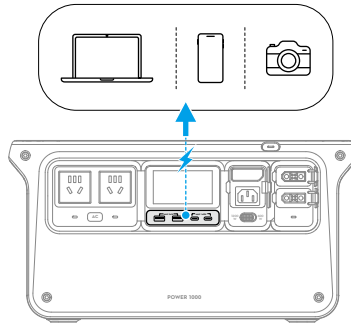

Fast Charging DJI Aircraft Batteries

DJI Power 1000 features an SDC port and an SDC Lite port, and DJI Power 500 features an SDC Lite port.

The power station can fast charge a supported DJI Intelligent Flight Battery using an SDC fast charge cable (sold separately).

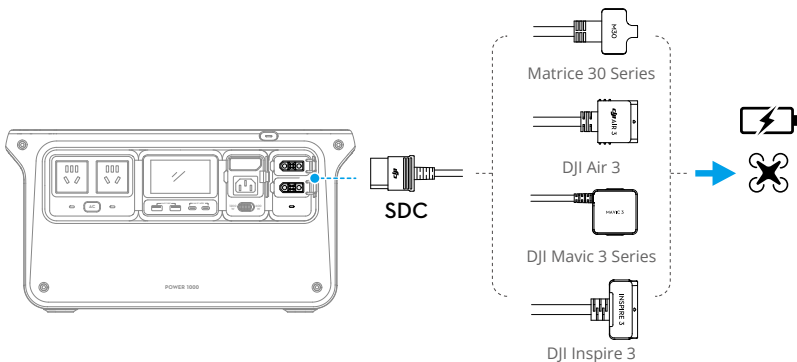

Other SDC Output

The power station can also be used with other SDC cables (sold separately) to charge different devices via the SDC/SDC Lite port.

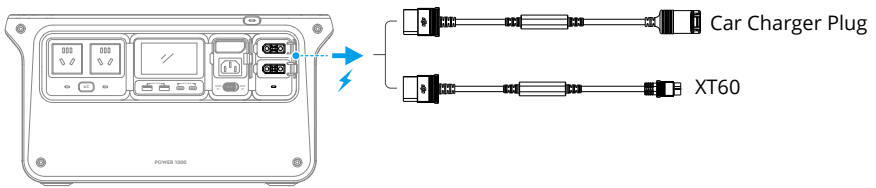

DJI Power SDC to Car Charger Plug Power Cable (12 V)

The power station can charge car-powered devices such as a car refrigerator using this cable.

- ⚠ • Make sure the external device is within the output specifications of the cable (voltage 13.6 V, current 10 A, power 136 W).
-

DJI Power SDC to XT60 Power Cable (12 V)

The power station can provide 12V DC input for devices with an XT60 port using this cable.

- ⚠ • DO NOT directly connect to a lithium battery with an XT60 port using the DJI Power SDC to XT60 power cable. Make sure to connect the power station to a balanced charger first.
-

Recharging the Power Station

AC Recharging

The power station provides Fast Recharge mode and Standard Recharge mode for AC recharging.

Fast Recharge Mode: in Fast Recharge mode, the recharge power is larger. It takes approximately 50 minutes to recharge the power station to 80%, and approximately 70 minutes to 100%.

Standard Recharge Mode: in Standard Recharge mode, the recharge power is lower and the operation noise is lower, which is suitable for recharging at night. Recharging in Standard Recharge mode can extend battery cell life. It takes approximately two hours to recharge the power station to 100%.

Take DJI Power 1000 as an example, follow the steps below for AC recharging:

1. Open the port cover, and connect DJI Power 1000 to an AC power outlet using the AC power cable in the package.
2. Toggle the recharge mode switch to set the recharge mode as 1200W Fast Recharge mode or 600W Standard Recharge mode. For DJI Power 500, the recharge mode can be set as 540W Fast Recharge mode or 270W Standard Recharge mode.

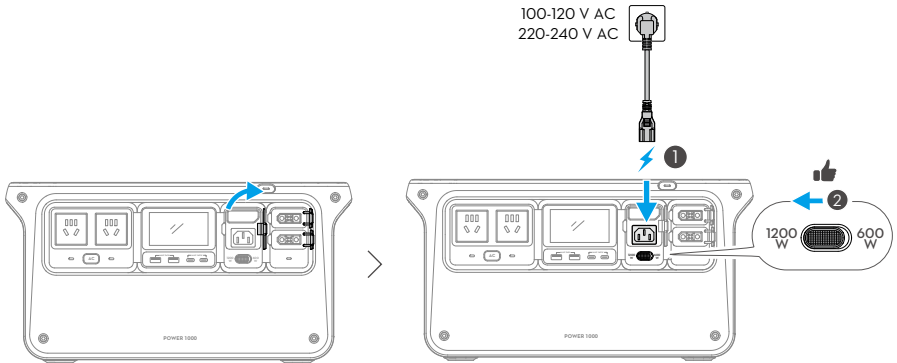

- ⚠️ • Disconnect the AC power outlet when charging is complete.
- It is recommended to use Standard Recharge mode for an extended battery cell life.
- The power station provides a battery cell life protection strategy. If the power station is recharged in Fast Recharge mode for five consecutive cycles, the power station will automatically switch to Standard Recharge mode after the sixth fast recharging for battery maintenance. The maintenance process lasts approximately 20 minutes.
- When the temperature is abnormal in Fast Recharge mode, the temperature error icon on the display screen blinks slowly and the actual recharge power may be lowered to ensure the battery cell life and safety.

Solar Recharging

The power station can be connected to solar panels using the DJI Power Solar Panel Adapter Module (MPPT) or DJI Power Car Power Outlet to SDC Power Cable for solar recharging. Both accessories are sold separately.

Take DJI Power 1000 as an example, follow the steps bellow for solar recharging:

1. Unfold the solar panel, support it with the prop, and align the panel towards the sunlight. Adjust the angle of the support prop. It is recommended that the surface of the solar panel is perpendicular to the sunlight. Make sure that the solar panel is not covered by any obstructions.
2. Connect the solar panel using a XT60 cable to the solar panel adapter module to begin recharging.

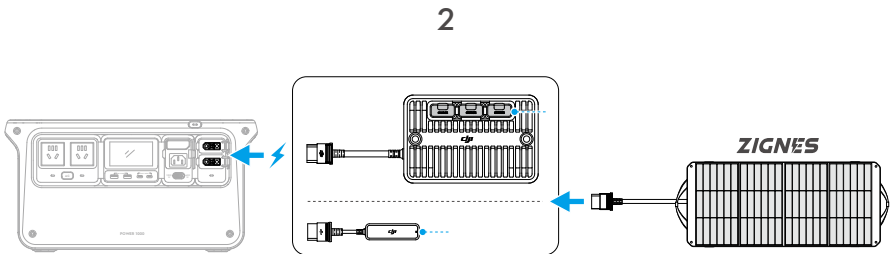
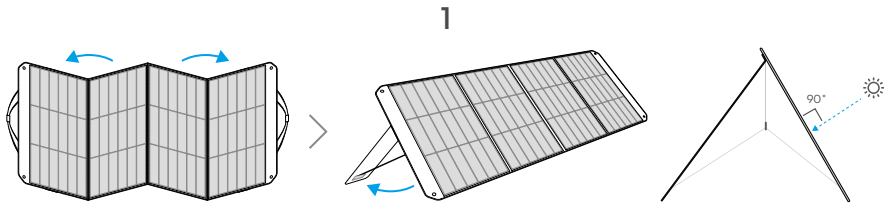

- ⚠️ Follow the instructions to use the solar panel. **DO NOT** mix solar panel types. Otherwise, the device may become damaged.
- Up to three solar panels can be connected to the adapter module and used in parallel (cannot be used in series). DJI Power 1000 can connect two solar panel adapter modules and up to six solar panels for solar recharging. DJI Power 500 can connect one solar panel adapter module and up to three solar panels for solar recharging.
- DJI Power Car Power Outlet to SDC Power Cable allows one solar panel to be connected for solar recharging. The maximum current of the solar panels should be lower than 10 A and the power output should be lower than 100 W.
- It is recommended to use DJI authorized Zignes solar panels. If non-recommended solar panels are used, make sure the solar panels meet all the following requirements in order to avoid damaging the solar panel adapter and the power station:

- ⚠ a. The open circuit voltage is lower than 30 V.
- b. The maximum current of one of the solar panels used is lower than 10 A.
- c. If more than one solar panel is used, the total power is lower than 400 W.
- For DJI Power 500, the maximum input power is limited to 300 W when using the SDC Lite port for solar charging.
- Keep the power station away from direct sunlight when recharging. Overheating can cause damage to the device.
- Prevent leaves and other objects from covering the surface of the solar panel. Placing the solar panel in a partially shaded area will affect the power generation efficiency and cause overcurrent, which can damage components.
- Moisten a soft cloth with clean water and wipe the surface to clean the solar panel.

Car Recharging

DJI Power Car Power Outlet to SDC Power Adapter can be used to connect a car power port to the SDC port (or SDC Lite port) of the power station for car recharging.

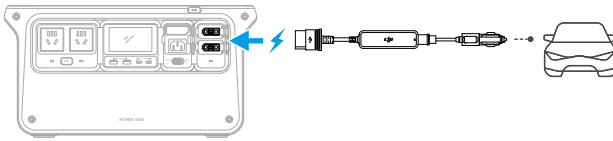

- ⚠ • Make sure the input voltage of the car power port is within 12-30 V and the maximum input current is lower than 8 A. Otherwise, it may cause abnormal performance or even damage to the power station.
- Make sure that the power adapter is securely connected to the car power port and that the car engine is started before recharging.

USB-C Recharging

DJI Power 500 can be recharged using a USB Power Delivery charger via the USB-C port for a maximum recharge power of 100 W. It also supports simultaneous power input, where two USB-C ports can be utilized to charge at a max of 200 W.

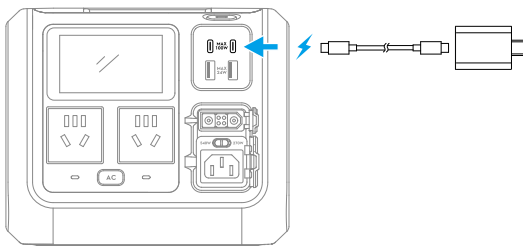

Uninterruptible Power Supply (UPS)

The power station supports Uninterruptible Power Supply (UPS). Connect the power station to an AC power outlet, and connect an external device such as a computer to the power station. Press the AC button once, and  will appear on the display screen. In this case, the AC power outlet is powering both the power station and the connected device. Note that UPS is enabled by default.

In case of a sudden power outage, the power station can automatically switch to the battery-powered supply within 20 ms, ensuring that the connected device remains in normal operation.

If there is a power outage and the power station runs out of battery, AC output can be automatically enabled after the power supply is resumed. Connect the power station to an AC power outlet and an external device, press and hold the AC button to enable this function.

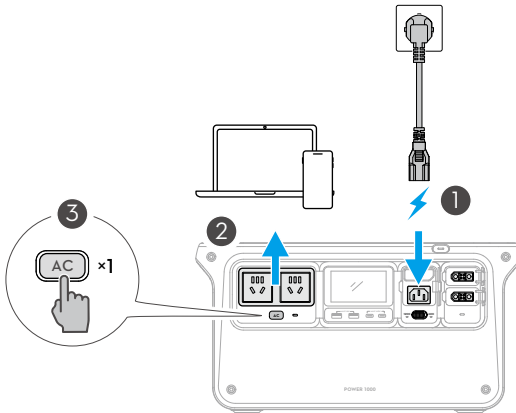

- The power station only supports the basic UPS feature and does not support 0ms switching. DO NOT connect the power station to devices that require 0ms UPS, such as medical equipment, data servers, or work stations storing important data. Otherwise, it may cause the device to malfunction or data loss.
- This function is unavailable in some regions. Refer to local laws and regulations for more information.

DJI Power 1000 Extensions

1/4" Thread Hole

DJI Power 1000 features two 1/4" thread holes, allowing users to mount the DJI Power Solar Panel Adapter Module (MPPT) to the power station as follows:

Mount one adapter module to the power station following Figure A.

Align the mounting holes at the bottom of the brackets and mount two adapter modules to the power station following Figure B.



- Users can also mount devices with 1/4" screws to the power station.

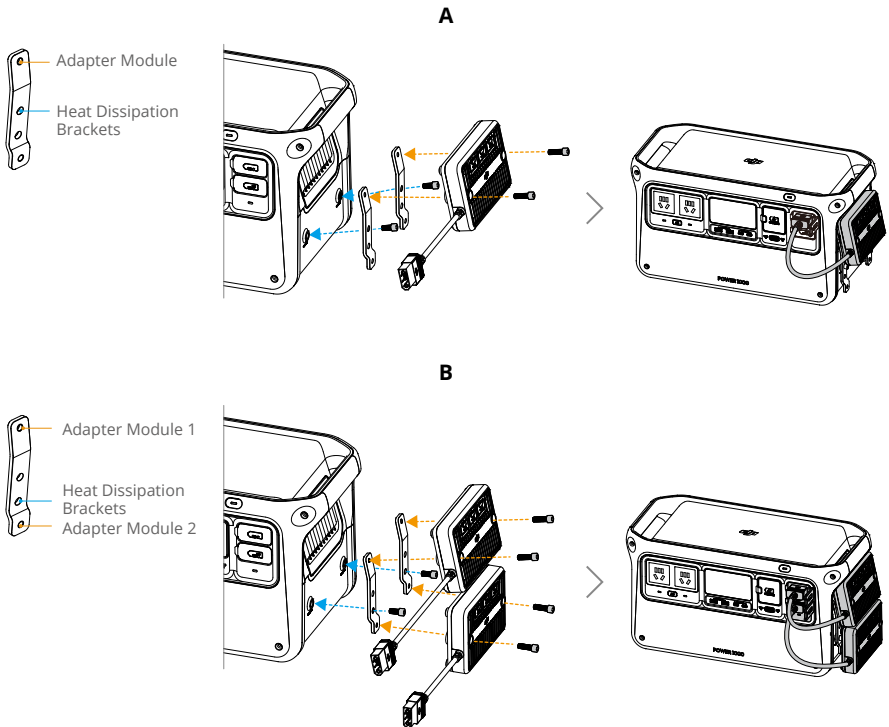

Protective Storage Bag

DJI Power 1000 can be used with the protective storage bag. The bag can protect the power station from scratches and dust, and make it more convenient to carry the power station.

Open the front of the bag for connecting external devices to the power station, and the rear of the bag is for storing cables and accessories.

When using DJI Power 1000 with the protective storage bag, make sure to unzip both sides of the bag in order to avoid blocking the vents, which may cause overheating.

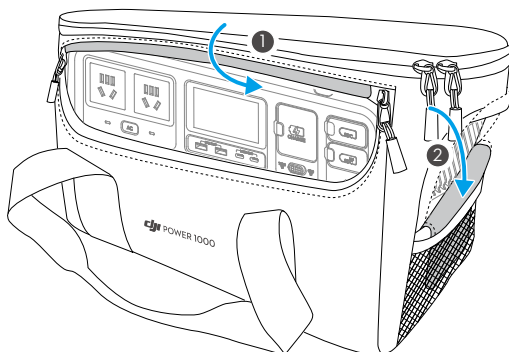

Appendix

Firmware Update

The firmware versions of DJI Power 1000 and DJI Power 500 can be updated using DJI Assistant 2 (Power Series). Make sure that the computer is connected to the internet before the firmware update. Follow the instructions below to ensure a successful firmware update:

1. Power off the device, press and hold the AC button and the power button simultaneously, until **LOAD** appears on the display screen.
2. Connect the computer to the designated USB-C port as shown in the figure.

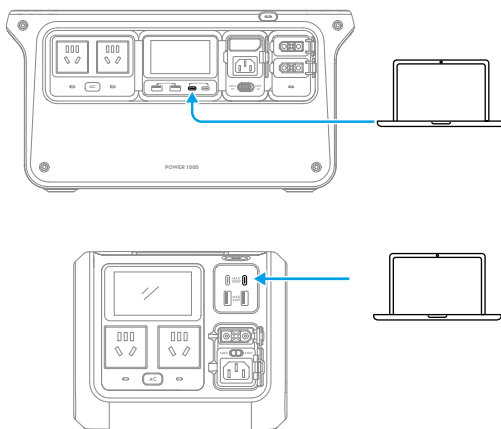

3. Connect the device to an AC power outlet if updating the firmware of DJI Power 1000 with a rated voltage of 100 V or 120 V. Skip this step if updating the firmware of other power station models.
4. Launch DJI Assistant 2, select the product, and click the firmware update button on the left side.
5. Select the firmware version, carefully read the prompts in DJI Assistant 2, and click Upgrade. The firmware will be downloaded and uploaded to the device automatically.
6. The firmware will be updated automatically, and the display screen will show the update progress. Wait for processing to complete. The device will restart automatically after the firmware update is done.



- DO NOT power off the device or disconnect the device from the computer during a firmware update.
- DO NOT disconnect the device from the AC power outlet when updating the firmware of DJI Power 1000 with a rated voltage of 100 V or 120 V.
- If the firmware update fails, the display screen will show UPGD FAIL. Disconnect the device from the computer and the AC power outlet, press and hold the power button for five seconds to power off the device, and try again.

Log Export

1. Press and hold the power button to power on the device
2. Quickly toggle the recharge mode switch for three times (one back and forth count as one time), then immediately press down the AC button. The USB-C icon will blink on the display screen, indicating that the device is in data export mode.

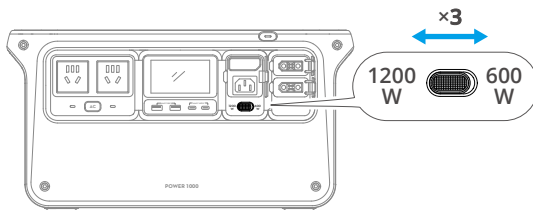

3. Connect the computer to the designated USB-C port as shown in the figure.

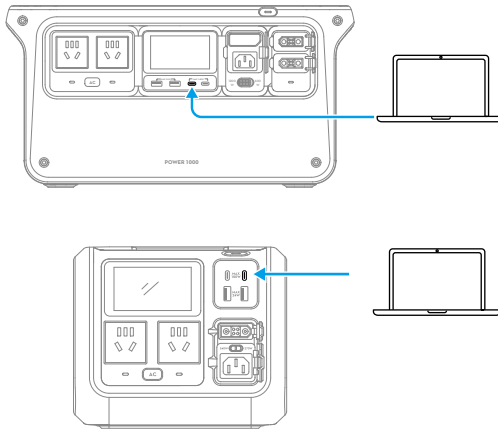

4. Run DJI Assistant 2, select the device model, click Log Export on the left side, and click Save to Local. Select a location to save the log. Wait for the export to complete.
5. Restart the power station to resume normal use after completing log export.

Troubleshooting

If there is any system warning on the display screen, click the link below or scan the QR code to learn about the warning details and the corresponding troubleshooting. Contact DJI support if a problem persists.



<https://s.dji.com/DJI-Power>

Maintenance

- If the power station needs to be stored for an extended period, it is recommended to discharge the power station to 60%. Storing with a low power level may lead to over-discharge.
- The power station should be stored at a storage temperature of -10° to 45° C (14° to 113° F), and in a cool and dry environment without direct sunlight. DO NOT place the power station in water or where water may leak.
- DO NOT store the power station for an extended period after fully discharging. Otherwise, the battery may over-discharge and cause irreparable damage to the battery cell.

- Charge and discharge the power station once every four months to ensure the battery performance: discharge the power station to 15%, power off for more than two hours, and then charge it to 100% in Standard Recharge mode.
- Clean the ports with a clean, dry cloth if there is any noticeable build up. DO NOT clean the power station with alcohol or other flammable solvents.

Accessory Options (Sold Separately)

Unless otherwise specified, the accessories are compatible with both DJI Power 1000 and DJI Power 500.

Zignes Solar Panel

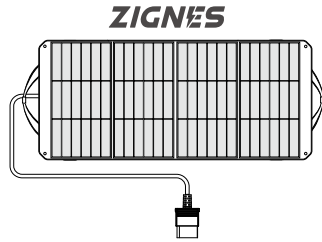

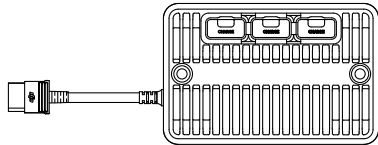

DJI Power Solar Panel Adapter Module (MPPT)

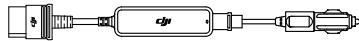

DJI Power Car Power Outlet to SDC Power Cable (12V/24V)

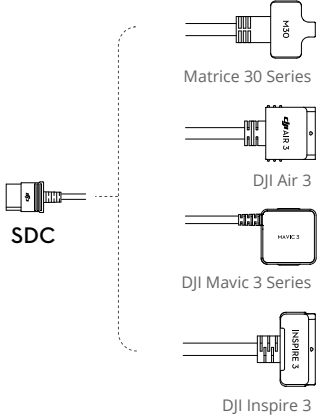

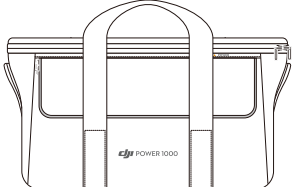
<p>DJI Power SDC to Matrice 30 Series Fast Charge Cable</p>	 <p>SDC</p> <p>Matrice 30 Series</p> <p>DJI Air 3</p> <p>DJI Mavic 3 Series</p> <p>DJI Inspire 3</p>
<p>DJI Power SDC to DJI Mavic 3 Series Fast Charge Cable</p>	
<p>DJI Power SDC to DJI Air 3 Fast Charge Cable</p>	
<p>DJI Power SDC to DJI Inspire 3 Fast Charge Cable</p>	
<p>DJI Power SDC to XT60 Power Cable (12V)</p>	
<p>DJI Power SDC to Car Charger Plug Power Cable (12V)</p>	
<p>DJI Power 1000 Protective Storage Bag (for DJI Power 1000 only)</p>	

Specifications

DJI Power 1000

General

Model	DYM1000L/DYM1000H
Capacity	1024 Wh
Net Weight	Approx. 13 kg
Dimensions	448×225×230 mm (L×W×H)
Max Operating Altitude	3000 m

Output Ports

AC Output ^[1] (×2)	DYM1000L: 100-120 V AC, 50/60 Hz, 1800 W (Rated), 2200 W (Max. continuous output) DYM1000H: 220-240 V AC, 50/60 Hz, 1800 W (Rated), 2200 W (Max. continuous output)
AC Output	DYM1000L: 100-120 V AC, 12 A, 1440 W DYM1000H: 220-240 V AC, 10 A, 2200 W
USB-A Output (×2)	5 V $\overline{\text{---}}$ 3 A / 9 V $\overline{\text{---}}$ 2 A / 12 V $\overline{\text{---}}$ 2 A Max output power per channel: 24 W
USB-C Output (×2)	5/9/12/15/20/28 V $\overline{\text{---}}$ 5 A Max. 140 W per port ^[2]
SDC Output (×2)	SDC ^[3] : 9-27 V, Max. 10 A, Max. 240 W SDC Lite: 9-27 V, Max. 10 A, Max. 240 W

Input Ports

AC Input	DYM1000L: 100-120 V AC, 12 A, 1200 W (recharging), 1440 W (bypass) DYM1000H: 220-240 V AC, 10 A, 1200 W (recharging), 2200 W (bypass)
SDC Input (×2)	SDC ^[3] : 32-58.4 V DC, Max. 400 W, Max. 8 A SDC Lite: 32-58.4 V DC, Max. 400 W, Max. 8 A

Battery

Cell Chemistry	LFP (lithium ferrophosphate)
Cycle Life ^[4]	Maintains over 80% capacity after 3000 cycles

Operating Temperature

Power Supply Temperature	-10° to 45° C (14° to 113° F)
Recharging Temperature	0° to 45° C (32° to 113° F)
Storage Temperature	-10° to 45° C (14° to 113° F)

[1] The maximum continuous power output is available when the battery level is higher than 20%. AC output data varies by country and region. Given that the voltage in Japan is 100 V, the max continuous output power of the Japanese version is 2000 W.

- [2] The USB-C port supports a max output power of 140 W. The device being charged must support the PD 3.1 protocol and use a USB cable that meets EPR specifications.
- [3] The SDC port supports extensive accessories.
- [4] Cycle Life is tested under the 600W Standard Recharge mode with an output power of 1000 W and a room temperature of 25° C (77° F).

DJI Power 500

General

Model	DYM500L/DYM500H
Capacity	512 Wh
Net Weight	Approx. 7.3 kg
Dimensions	305×207×177 mm (L×W×H)
Max Operating Altitude	3000 m

Output Ports

AC Output ^[1] (×2)	DYM500L: 100-120 V AC, 50/60 Hz, 800 W (Rated), 1000 W (Max. continuous output) DYM500H: 220-240 V AC, 50/60 Hz, 800 W (Rated), 1000 W (Max. continuous output)
AC Output (Bypass mode)	DYM500L: 100-120 V AC, Max. 1000 W DYM500H: 220-240 V AC, Max. 1000 W
USB-A Output (×2)	5 V $\overline{\text{---}}$ 3 A / 9 V $\overline{\text{---}}$ 2 A / 12 V $\overline{\text{---}}$ 2 A Max output power per port: 24 W
USB-C Output (×2)	5/9/12/15/20 V $\overline{\text{---}}$ 5 A Max. 100 W per port (Needs support of PD3.0 protocol)
SDC Output	SDC Lite: 9-27 V, Max. 240 W

Input Ports

AC Input	DYM500L: 100-120 V AC, 540 W (recharging), 1000 W (bypass) DYM500H: 220-240 V AC, 540 W (recharging), 1000 W (bypass)
SDC Input	SDC Lite: 22.4-29.2 V DC, Max. 300 W, Max. 10 A
USB-C Input	5-20 V DC, Max. 100 W (Need support of PD protocols) Supports simultaneous power input with two USB-C ports at a max 200 W.

Battery

Cell Chemistry	LFP (lithium ferrophosphate)
Cycle Life ^[2]	Maintains over 80% capacity after 3,000 cycles

Operating Temperature

Power Supply Temperature	-10° to 45° C (14° to 113° F)
--------------------------	-------------------------------

Recharging
Temperature 0° to 45° C (32° to 113° F)

Storage Temperature -10° to 45° C (14° to 113° F)

- [1] The maximum continuous output power is available when the battery level is higher than 20%.
- [2] Cycle Life is tested in the 270W Standard Recharge mode with an output power of 500 W and a room temperature of 25° C (77° F).

WE ARE HERE FOR YOU



Contact
DJI SUPPORT

This content is subject to change without prior notice.



<https://www.dji.com/power-1000/downloads>
<https://www.dji.com/power-500/downloads>

If you have any questions about this document, please contact DJI by sending a message to DocSupport@dji.com.

DJI is a trademark of DJI.
Copyright © 2024 DJI All Rights Reserved.