







-  X3
-  X3
-  X3
-  X3
-  
- ② ③
- X3 X1



1. Let the wire of the fixture go through the hanging tube 2 and tube 3, rotate to install tubes to the fixture. (can connect more tubes to get the height you need)
2. Let the wire go through the canopy 4, rotate to install the canopy 4 to the fixture.
3. Install the bracket to the ceiling junction box with screw .
4. Connect the wire to the home line with cap connector.
5. Install the fixture to the bracket with screw.
6. Install the bulb.(bulb is not included in the package)

Please read carefully before installation!!!

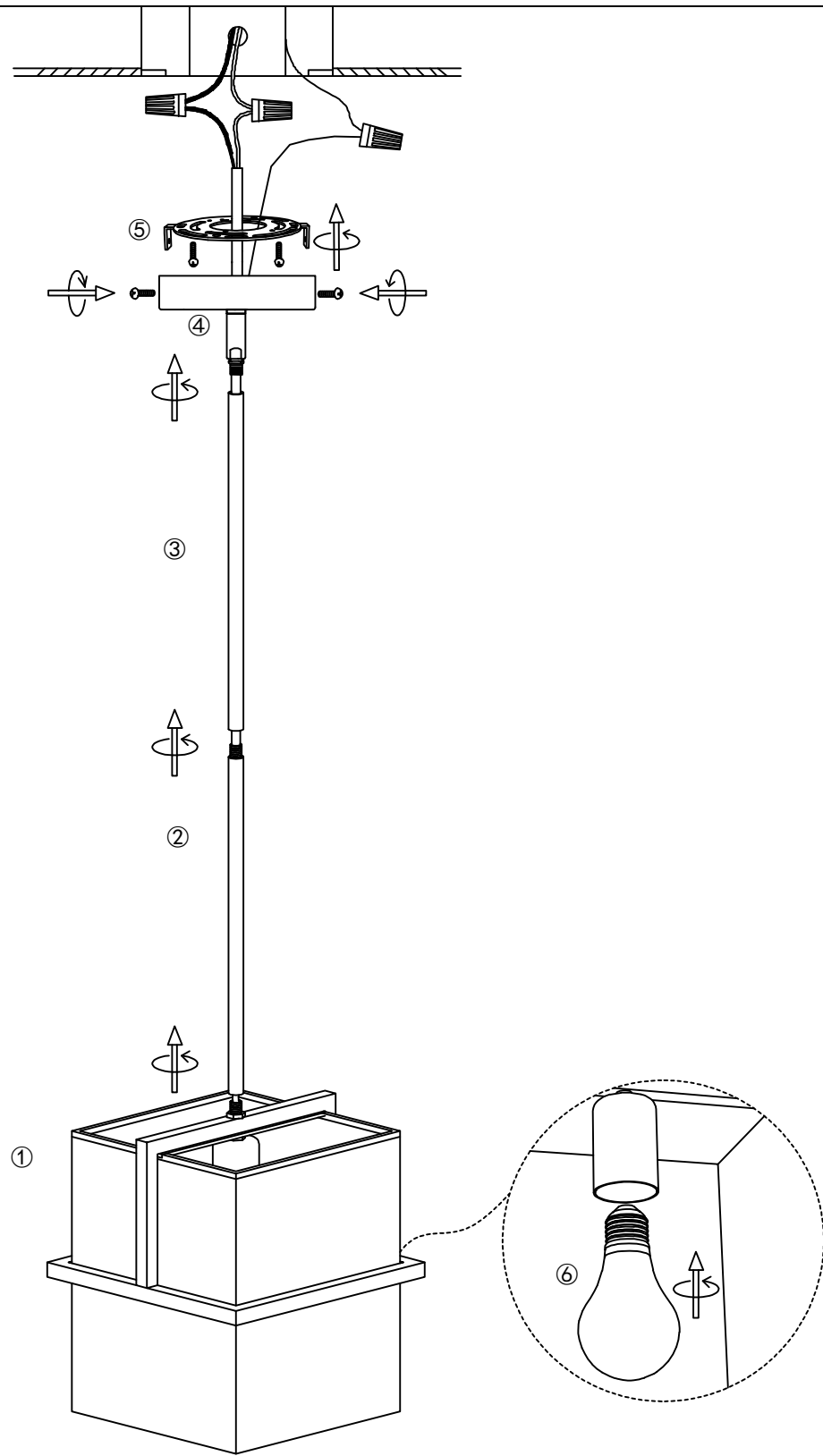
Note : Please make sure that the electricity is powered off during installation ! Only a professional electrician should install this kind of product !