

SMART PXL 100x25 Dot - Installation Guide

High Resolution Smart 100x25mm RGB/RGBW pixel dot (24V & 48V)



Contents

Physical Dimensions	2
Key Electrical Safety	4
Protection from Injury During Installation	4
System Planning and Specification	5
Key Safety & Functional Limits	5
Voltage Drop	5
Maximum Smart PXL-100x25 Dot Chain Length	5
Connection to a DC PSU	6
Data Cable Length & Direction	6
Control Channels.....	6
Controlling Smart PXL Dots with ENTTEC OCTO's	7
OCTO System Application Diagram	8
Controlling Smart PXL Dots with ENTTEC's Pixelator System	9
Pixelator System Application Diagram	10
Installation Guidelines	11
Surface installation of Smart PXL-100x25 Dots & Accessories	11
Catenary mounting	12
Marking the surface.....	12
Servicing, Inspection & Maintenance	13
Cleaning.....	14
Part Codes & Ordering Information	14
Smart PXL Dots.....	14
Smart PXL Dot Accessories.....	14

Physical Dimensions

Note: Lenses are non-removable

Smart PXL-100x25 Dot

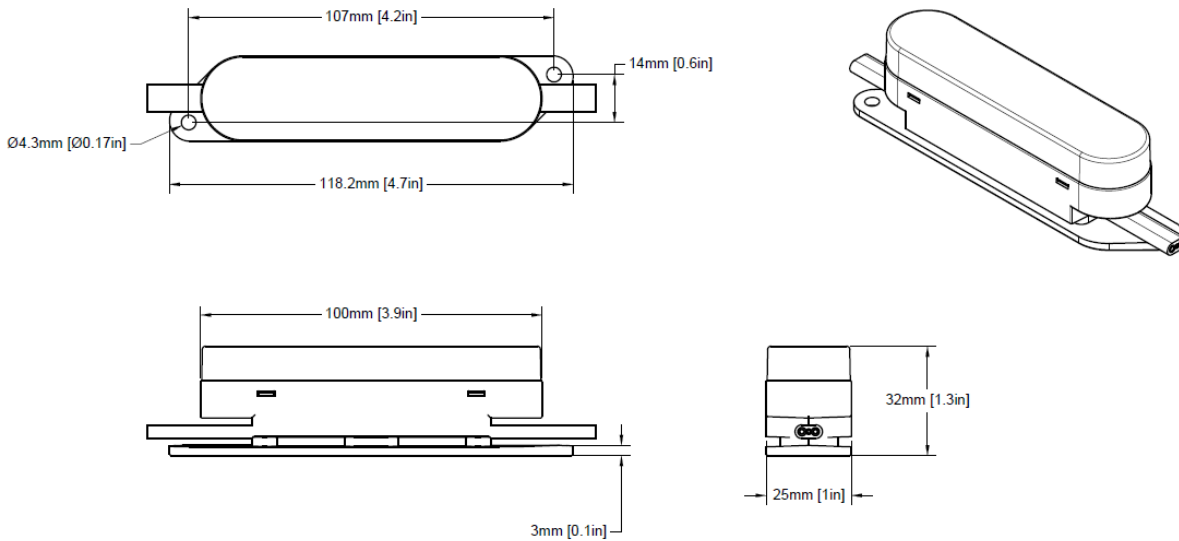

Amphenol AT Series Connector

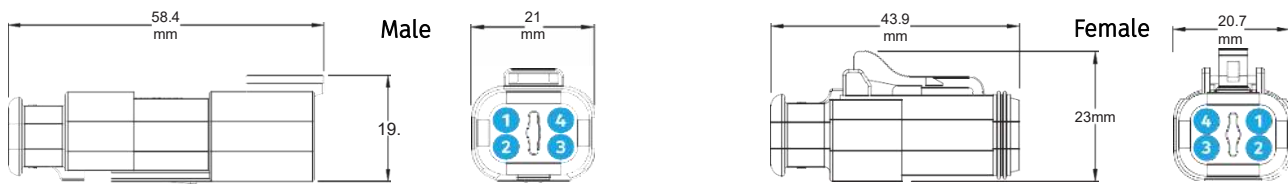

All ENTTEC Smart PXL Dot accessories are fitted with the same Amphenol AT series connectors and industrial grade heat shrink as the Smart PXL Dots to provide additional durability. Each cable accessory has a 68mm bend radius – View each accessories datasheet for more information.

Smart PXL – 2m Male Cable

Used as a convenient method to connect your Smart PXL Dot's output to a connection block or other device.

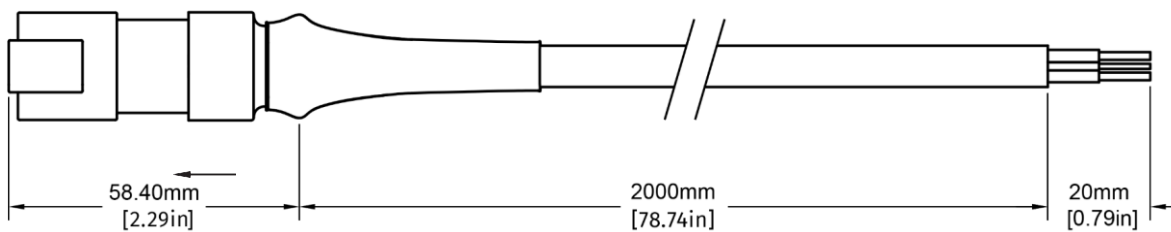

Smart PXL – 2m Female Cable

Used as a convenient method to connect your Smart PXL Dot strings to a connection block or other device.

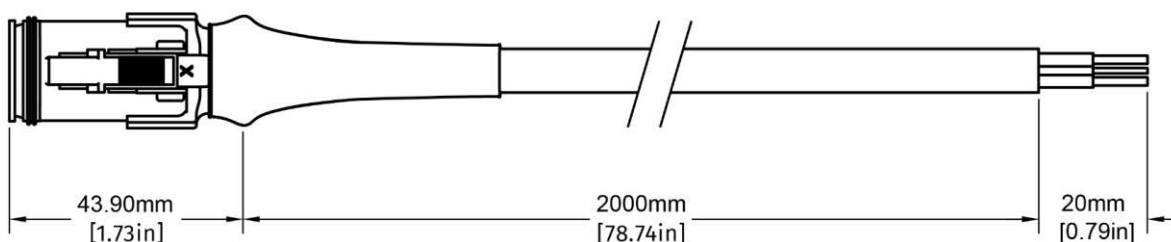

Smart PXL – Power Injector

Used to combat voltage drop and injecting up to 10A of power. The power injector accessory features reverse polarity and transient voltage protection.

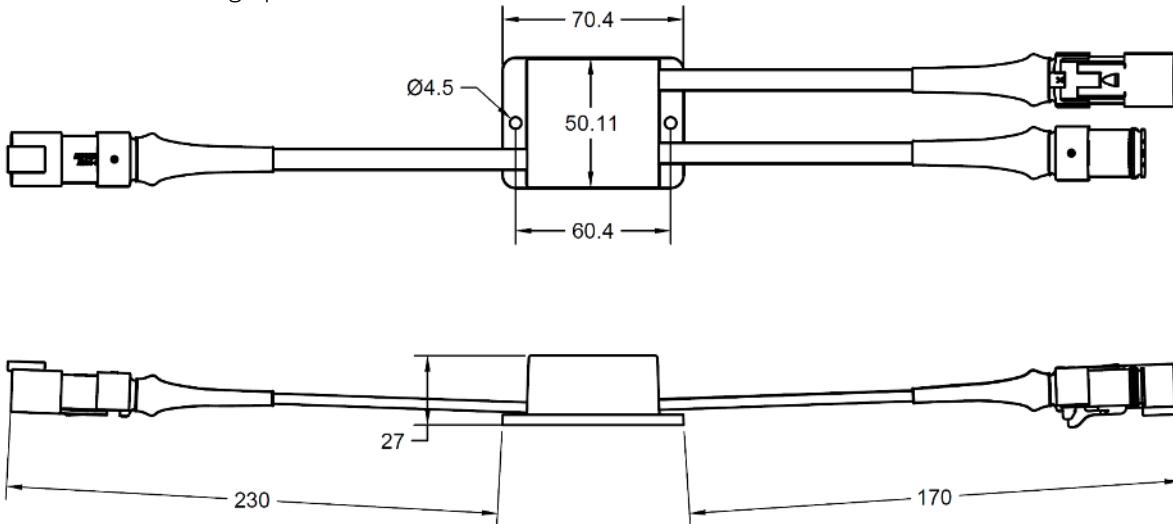

Smart PXL – 2m Extension (See ordering info for PN)

Used as a convenient method extend the distance between each Smart PXL Dot string. Refer to voltage drop section for maximum extension length.

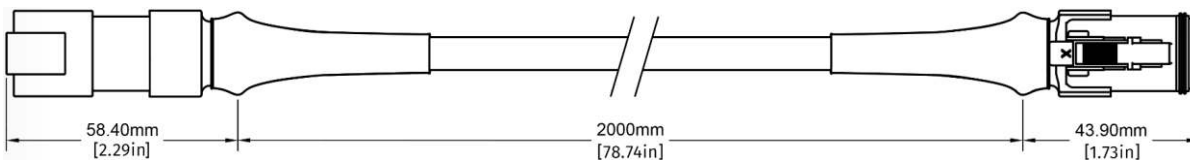

Smart PXL – Termination End Cap

The Smart PXL Termination End Cap should be attached at the end of a chain of Smart PXL DOTs to protect the final female Amphenol AT series connector from short circuiting and corrosion in wet conditions. This can be secured to a surface using an m5 screw or bolt.

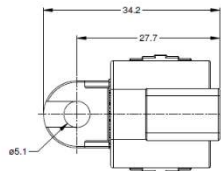

Cable Core Identification Chart

Each Smart PXL string or accessory is comprised of 3 cores, the pinout is as follows:

24V		
Cable color	Function	Pin on Amphenol Connector
Black	0V	1
White	Data	2
Red	+24V DC	4
48V		
Cable color	Function	Pin on Amphenol Connector
Black	0V	1
White	Data	2
Red	+48V DC	3

ENTTEC recommend the use of cable ferrules when connecting non-tinned cable.

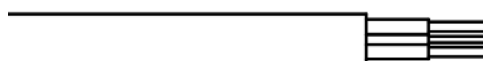

Check and respect all directions and warnings given within this installation guide before specifying, installing and operating a Smart PXL Dot system. If you are unsure or still have any questions about how to install or operate this product safely, please contact your ENTTEC supplier or speak with ENTTEC directly.

Key Electrical Safety



- This product must be installed in accordance with applicable national and local electrical and construction codes by a person familiar with the construction and operation of the product and the hazards involved. Failure to comply with the following installation instructions may result in death or serious injury.
- This device can be damaged by excess voltage. The installation of an overvoltage protection device on the electrical system may reduce the risk of damage.
- Provide a means of locking out AC mains power to the installation to be shut down and made impossible to reapply accidentally.
- The use of an adequate RCBO along the mains power inlet to your installation is recommended.
- Before applying power to the installation, check that all power distribution equipment and cables are in a perfect condition and rated for the current requirements of all connected devices and factor in overhead.
- Isolate the installation from power immediately if Smart PXL Dots, accessories power cables or connectors is in any way damaged, defective, shows signs of overheating or are wet (if not an IP67 component).
- Do not exceed the maximum numbers of Smart PXL Dots and accessories that can be connected and the maximum cable lengths specified in this guide and other product documentation.
- To reduce the risk of fire or electrical faults do not exceed the ratings and limitations defined in the product datasheet or this guide.
- Do not hot swap Smart Pixel strings or accessories.
- Shut down power to the installation during cleaning in addition to when the system is not in use.

Electrical Information



- This device operates on DC power and excludes an earth connection.

Installation Safety



- Do not bend the Smart PXL Dot cable into a curve of less than 30mm(1.18in) radius.
- Do not bend the round Smart PXL Dot accessory cable into a curve of less than 68mm(2.68in) radius.
- Do not over stretch cabling sections of your Smart PXL Dots.
- Do not operate the Smart PXL Dots if the ambient temperature exceeds 50°C (122°F).
- The Smart PXL Dots are convection cooled, ensure sufficient airflow can reach each dot to allow heat to be dissipated.
- Do not cover or enclose Smart PXL Dots without a suitable and proven method of dissipating heat.
- To contribute to an optimum operating temperature, where possible keep this device out of direct sunlight.
- Do not modify the Smart PXL Dots system in any way.
- Follow all steps in the installation guidelines section of this document.

Protection from Injury During Installation



- Always use suitable personal protective equipment when installing ENTTEC products.
- When installing the Smart PXL Dots above ground level, ensure that the installation hardware and supporting structure can hold the weight of all the devices they support.
- In an overhead installation or where the Smart PXL Dots system may cause injury if it falls. Block access below the work area and work from a stable platform whenever installing, servicing or moving the Smart PXL Dots system.
- Once installation is completed, check that all hardware and components are securely in place and fastened to supporting structures.

System Planning and Specification



Before planning or installing your system, ensure you are familiarized with all key information within this guide and other relevant ENTTEC documentation. If you are in any doubt about system safety, or you plan to install ENTTEC's Smart PXL Dots in a configuration that is not covered within this guide, contact ENTTEC or your ENTTEC supplier for assistance.

ENTTEC's Return to Base warranty for this product does not cover damage caused by inappropriate use or application or modification to the product.

The first step of planning an installation is to determine the pixel pitch and total quantity of Smart PXL Dots required. Use the product datasheet to determine the light output and pixel pitch your installation requires before beginning your system design.

Key Safety & Functional Limits



Given the versatility and flexibility of the Smart PXL Dot system, it is imperative that the system layout stays within the limits defined within this document. If two or more different limits apply to a configuration, you must always follow the lowest.

The system design and installation must respect the key safety and functional limits defined within this guide.

These limits are:

- **Power Draw**
- **Voltage Drop**
- **Current throughput limit per string (10A max)**
- **Control channel availability**

Voltage Drop

The longer the cable distance from the power source to each dot the more voltage is dropped. Significant voltage drop can result in lower brightness and in more extreme cases colour shift.

This is an important consideration for Smart PXL installations with custom pixel pitch and can inform the quantity of dots per string between power injections.

If cable length can be reduced across your installation, this is recommended.

If you are concerned about voltage drop and the impact on your installation, contact ENTTEC team or your reseller.

Maximum Smart PXL-100x25 Dot Chain Length

Maximum chain length is determined by voltage drop, power consumption (10A max throughput) and control channel availability.

Please contact ENTTEC team or reseller for maximum dot chain length fitting your requirement.

By using ENTTEC's Smart PXL Power Injector accessory to inject power from additional PSU's, the impact of voltage-drop and power consumption can be removed, leaving control channel availability as the only limiting factor.

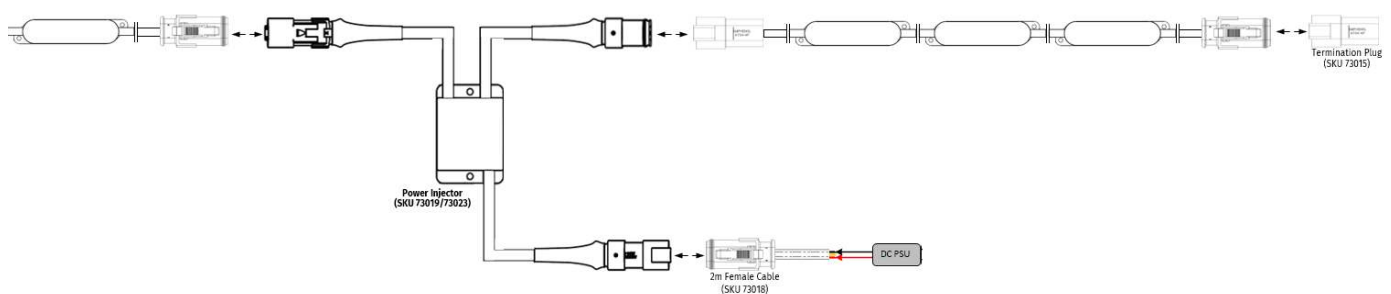

Connection to a DC PSU

In a Smart PXL installation, one or more DC external PSUs (Power Supply Units) are required to provide power to each chain of Smart PXL Dots if your control method does not contain an integrated PSU.

Your power supply should be located as close as physically possible to the beginning of the chain of Smart PXL Dots to minimize the effect of voltage drop.

For optimum performance and to reduce the impact of voltage drop, ENTTEC recommend the use of multiple smaller DC power supplies at the beginning of each run of Smart PXL Dots, instead of a low quantity of high-capacity power supplies with longer connection cables.

ENTTEC recommend IP67 rated or higher power supplies where applicable with your installation requirement.

The maximum number of Dots that you can safely connect to a PSU is dependent on the selected PSU's power rating.

The total power consumption of a single chain of Smart PXL Dots must not exceed the PSU's maximum power rating OR the 10A current throughput limit of each Smart PXL Dot. To determine the total power consumption of a chain of ENTTEC Smart PXL Dots, add together the power consumption for all individual Dots by referring to datasheet - electrical information.

ENTTEC's offers various control system options to drive Smart PXL Dots each designed for different use case scenarios.

Information for each control system type and appropriate wiring methods can be found within the **Control Methods** section of this guide. Ensure all cabling and control systems have been housed in accordance with the specifications defined within each products datasheet and in line with local electrical regulation.

Data Cable Length & Direction

Smart PXL Dots are controlled using ENTTEC's proprietary S-PXL 8/16 protocol. This protocol sequentially addresses each Smart PXL Dot automatically. This reduces commissioning time by eliminating the need for individual addressing.

Each Smart PXL Dot contains its own data buffering and data, re-shaping circuit. The maximum permissible distances distance between devices is as follows:

Max. distance between S-PXL 8/16 data source	3000mm
Max. distance between Smart PXL string interconnects	3000mm

S-PXL data flow through each dot in one direction only. This direction is indicated by the direction of the arrow printed on surface of the dot (center of PCB). In the event surface of PCB is inaccessible, data direction always flows as illustrated with respect to ENTTEC logo on bottom of housing.



- **For best practice keep all cable run lengths to a minimum to avoid electrical noise.**
- **Avoid running data cabling close to mains power or devices that emit electromagnetic noise (i.e. air conditioning units).**
- **If data direction instructions are not followed, Smart PXL Dots will not operate.**

Control Channels

Each RGB Smart PXL Dot consumes the equivalent of 6 DMX channels of data.

Each RGBW Smart PXL Dot consumes the equivalent of 8 DMX channels of data.

The hard upper limit to the number of dots you can run from one data feed can be calculated by dividing the maximum number of data channels per output of the ENTTEC pixel controller by the DMX channel footprint of the Smart PXL Dot.

Each Smart PXL Dot uses 6 or 8 output channels from your controller respectively, whether running in an 8-Bit, 16-Bit or grouped configuration all Smart PXL Dots in a chain will sequentially address one after another.

16-Bit Smart PXL-100x25 Dot RGB DMX Channel Footprint						
Channel Order	1	2	3	4	5	6
Attribute	Red	Red Fine	Green	Green Fine	Blue	Blue Fine

The quantity of Smart PXL Dots addressable per ENTTEC controller is as follows:

	16-Bit Smart PXL-100x25 Dot RGBW DMX Channel Footprint							
Channel Order	1	2	3	4	5	6	7	8
Attribute	Red	Red Fine	Green	Green Fine	Blue	Blue Fine	White	White Fine



Always consider all limiting factors before finalizing your system design.

Smart PXL Dot Control Options

ENTTEC's offers various products to control Smart PXL Dots, each designed for different use case scenarios.

Key specification information and application diagrams for each system can be found within the following section.

Controlling Smart PXL Dots with ENTTEC OCTO's

The OCTO is a 4 DIN module wide device capable of converting a combined total of 8 universes of pixel data from ArtNet, sACN or KiNet (4 universes per output) with a wide operating voltage between 4-60V DC.

It contains an inbuilt network switch for simple device chaining, allowing up to 100m between each device.

The OCTO's inbuilt web interface allows configuration alongside basic standalone effects generation for times your installation doesn't require control from a centralised playback device.



ENTTEC Controller	SKU	Form Factor	Dimming Control Resolution	Outputs per Device	Total DMX Channels Per Output
OCTO	71521	4 module DIN (IP-20)	8-Bit/ 16-Bit	2	2048 (4U)

For more information on the products & accessories featured within this guide visit enttec.com

OCTO System Application Diagram



Key OCTO Installation Guidelines:

- Ensure all safety guidelines within this installation guide and other product documentation are factored into the design.
- Locate the OCTO and PSU as close as possible to the first Smart PXL Dot in the chain to reduce the impact of voltage drop.
- To reduce the likelihood of voltage being induced on the control signal lines, where possible, run control cabling away from mains electricity or devices that produce high EMF, (i.e. air conditioning units).
- ENTTEC recommends the use of cable ferrules for all stranded cables connected to the OCTO's screw terminals to ensure a reliable connection.

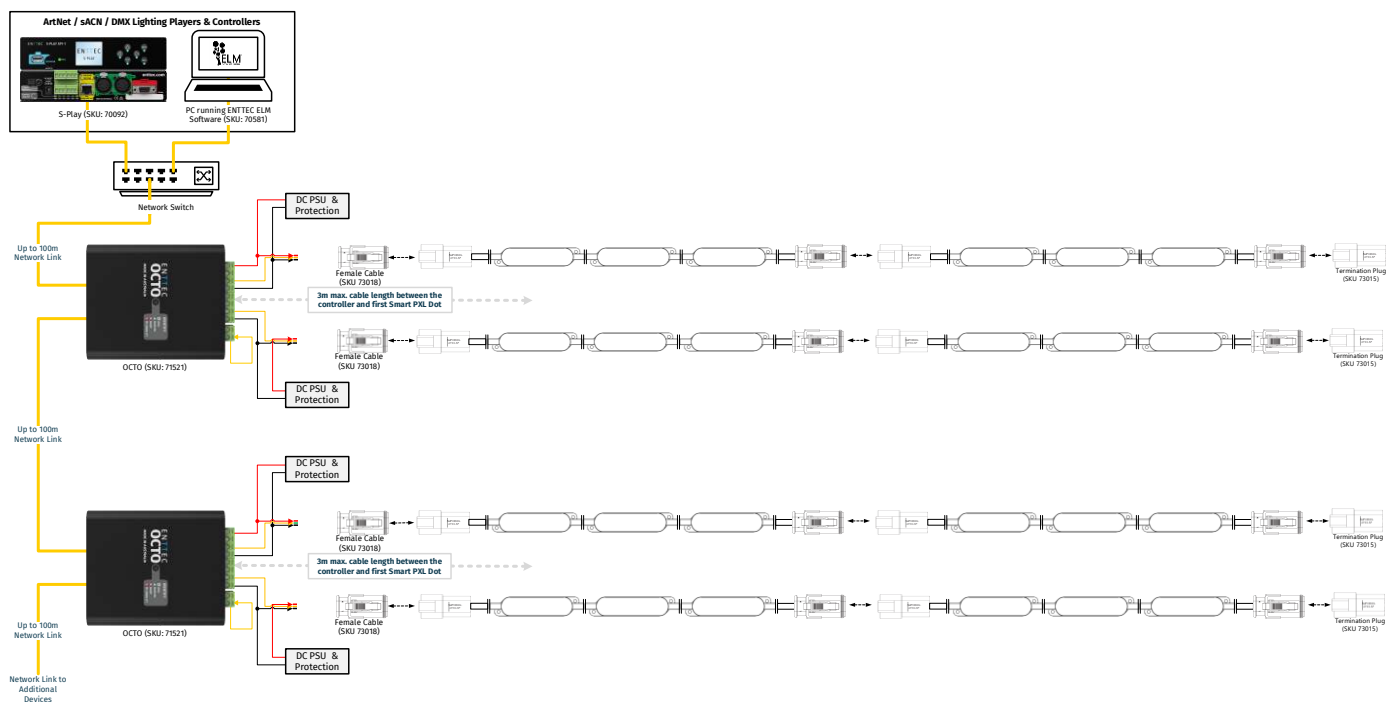

Note: If the power or data source to your controller drops out whilst the Smart PXL Dots remain powered, the last state will be held until either the data feed resumes or power to the Smart PXL Dots is disconnected and re-connected.

Controlling Smart PXL Dots with ENTTEC's Pixelator System

ENTTEC's Pixelator system has been designed with reliability and flexibility at its heart. The system comprises of two key elements. The Pixelator device used to perform protocol conversion, and PLink injectors used locally to convert the data from the Pixelator close to the beginning of each chain of dots.

Pixelator Devices

Each Pixelator device is configurable via web interface over a local network and converts DMX over ethernet (Art-Net, sACN or ESP) to ENTTEC's proprietary PLink protocol designed to send control data over long distances. Each PLink output can send 2 universes of data up to 300m over CAT6 cable to ENTTEC's PLink injector modules.



ENTTEC Controller	SKU	Form Factor	Dimming Control Resolution	Outputs per Device	Total DMX Channels Per Output
Pixelator	70060	19" Rack 1RU (IP-20)	8-Bit / 16-Bit	24	1024 (2U)
Pixelator Mini	70066	9.5" Rack 1RU (IP-20)	8-Bit / 16-Bit	8	1024 (2U)
DIN Pixelator Mini PX1-8D	71066	8 Module DIN (IP-20)	8-Bit / 16-Bit	8	1024 (2U)



Do not mix controller types within a P-Link System. Different Pixelator models use different processing power appropriate to the hardware design. If your installation requires multiple Pixelators, standardize on one variant to eliminate the risk of content tearing.

PLink Injection Modules

ENTTEC's compact PLink power injection modules are available in both indoor and outdoor variants. These surface mount modules convert PLink signal from the Pixelator to the S-PXL8 / S-PXL16 protocols without configuration. The two variants compatible with Smart PXL Dots are as follows:



ENTTEC Injection Module	SKU	IP Rating	Data Outputs per Device
Plink Injector (12-24v)	73544	IP-20	1
IP66 Plink Injector (custom / made to order item – contact the ENTTEC sales team)	73924	IP-66	1

For more information on the products & accessories featured within this guide visit enttec.com

Pixelator System Application Diagram



Key Pixelator System Installation Guidelines:

- Ensure all safety guidelines within this guide and other product documentation are factored into the design.
- Locate the PLink and PSU as close as possible to the first Smart PXL Dot in the chain to reduce the impact of voltage drop.
- To reduce the likelihood of voltage being induced on the control signal lines, where possible, run control cabling away from mains electricity or devices that produce high EMF, (i.e. air conditioning units).
- ENTTEC recommends the use of cable ferrules for all stranded cables connected to the PLink's screw terminals to ensure a reliable connection.

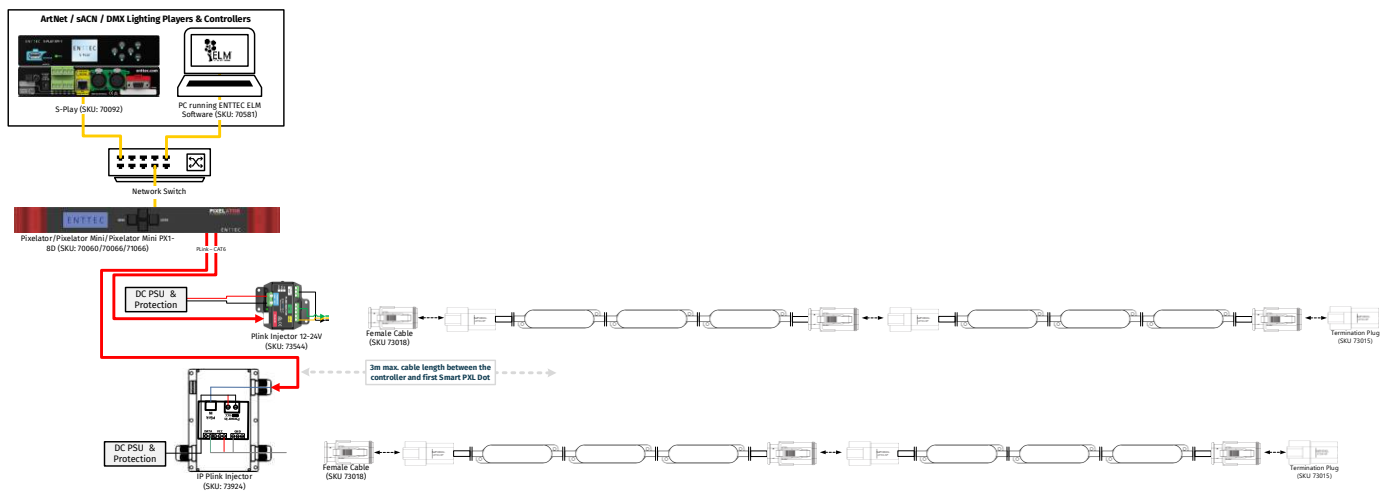

Note: If the power or data source to your controller drops out whilst the Smart PXL Dots remain powered, the last state will be held until either the data feed resumes or power to the Smart PXL Dots is disconnected and re-connected.

Installation Guidelines

Always work with a plan of the installation that respects all system limitations as defined within this guide and adheres to the safety information on the first page.



- **Ensure data is flowing from your controller through the string of dots following the data direction.**
- **Do not cover Smart Pixel Dots with insulating material of any kind.**
- **When installing dots or accessories DO NOT exert any tension on the cabling whilst tightening.**



- **Installation of this product must be performed by qualified personnel. If ever unsure always consult a professional.**
- **Ensure that no part of the installation is or can be connected to power until all work is complete.**
- **Do not install Smart PXL Dots if cabling is damaged.**
- **Before connecting Smart PXL Dots to a power supply, verify that the operating voltage and frequency are compatible and the power supply is appropriately fused in.**
- **Do not crush or clamp Smart PXL Dot or accessory cabling during installation.**
- **Do not leave connections unprotected or disconnected in damp or wet environments. All exposed connectors should be fitted with a Termination Plug (SKU 73015) to give a watertight seal to protect against corrosion.**
- **Do not handle Smart PXL Dot strings in an energized state.**
- **Do not bend the Smart PXL Dot cabling to a radius smaller than 30mm (1.18in).**
- **Do not bend the round Smart PXL Dot accessory cable into a curve of less than 68mm(2.68in) radius.**
- **Do not 'hot swap' Smart PXL Dot strings or their accessories.**
- **Do not leave connectors or accessory cabling in a position where they could cause a short circuit.**
- **Isolate the installation from power immediately if Smart PXL Dots, accessories power cables or connectors is in any way damaged, defective, shows signs of overheating or are wet (if not an IP67 component).**
- **Do not sign off a system without ensuring all Smart PXL Dot and accessory cabling is appropriately restrained, secure and not under tension from the way it has been installed.**

Surface installation of Smart PXL-100x25 Dots & Accessories

The Smart PXL-100x25's body features 2 * 4.3mm Dia holes designed for use with suitable fasteners to support the weight of the full Smart PXL Dot string.

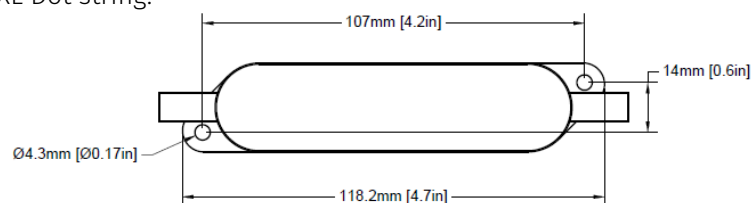

Cable termination end caps (SKU: 73015) feature a single M5 hole for use with pan head screws and bolts.

ENTTEC produces Smart PXL Dot cable accessories for increased convenience on site. All accessories use the same connectors as the Smart PXL Dot's. Cabling should be restrained with cable clips suited to the surface you are mounting your Smart PXL installation to every 0.5m.

Accessories should be used in-line with the system design considerations of your selected controller and adhere to the system cable length limitations.

Ordering information can be found at the end of this document.

Catenary mounting

ENTTEC recommends UV-resistant, outdoor-use rated cable ties for 2 wire catenary support of the SmartPXL dots via the mounting holes to eliminate any rotational stress. Do not place cable tie directly to cable leading in/out of SmartPXL dot. Positioning cable ties over cable close to dot body will prevent cable from acting as strain relief for the system and may void the warranty.

If the pitch cable is sagging and needs to be restrained for aesthetic purposes, a cable tie can be used, but should be positioned as far away from the dot or heatshrink parts as possible. Do not tighten the cable tie tight to the catenary cable as this will prevent the system from flexing and dampening strain on the cable. It can also cause the cable to rub against the catenary wire and wear away the insulation.

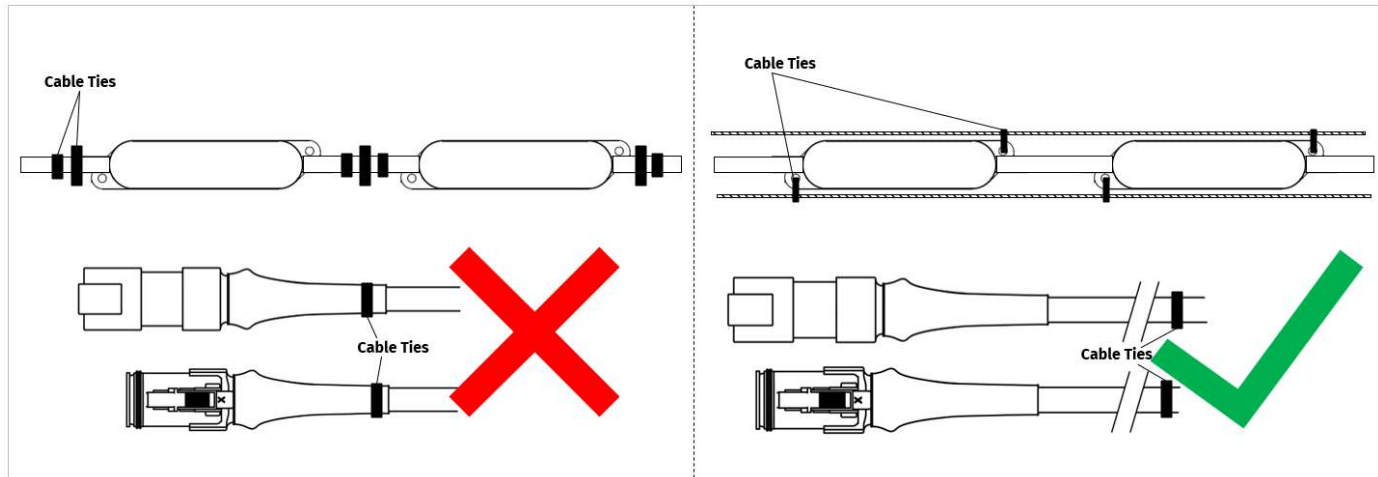

- Only drill holes or tighten screws into a surface that do not have cabling, pipework or other services directly behind.
- Never energize a Smart PXL Dot system until installation is complete and it is safe to do so.



- Ensure the surface you are attaching Smart PXL Dots and accessories can support the weight of all items you attach.
- When mounting Smart PXL Dots and accessories, ensure the mounting method is suitably rated to support the weight of the full Smart PXL Dot string.
- Never drill a hole or tighten screws into a surface using a Smart PXL Dot or accessory as a guide. This can result in damage and compromise the strength of the product.
- If installing Smart PXL Dots outdoors, only use corrosion proof galvanized, or stainless-steel fixings rated for the installation conditions.
- Never allow a string of dots to hang from a structure during installation, this can result in strain to cabling and damage to the Smart PXL Dots.

Marking the surface

Hold a Smart PXL-100x25 Dot or your Cable termination end cap up to the surface and accurately mark the hole positioning with a pencil, ensuring that the spacing between each dot and accessory will not exert any strain on the Smart PXL Dot cable.

Protect the Smart PXL Dot's from debris or swarf whilst drilling pilot holes.

Note: When installing, **DO NOT** connect the Smart PXL Dot cabling until the screw has been fully tightened to protect it from any un-necessary strain.

Screws

If securing Smart PXL Dots or accessories using machine or self-tapping screws.

Drill a pilot hole or partially wind a self-tapping screw on the pencil mark as defined in the previous section before positioning the Smart PXL Dot.

Position each Smart PXL Dot in-line with the entry points, then insert and fully tighten the screws. **DO NOT** exert any tension on the cabling whilst tightening.

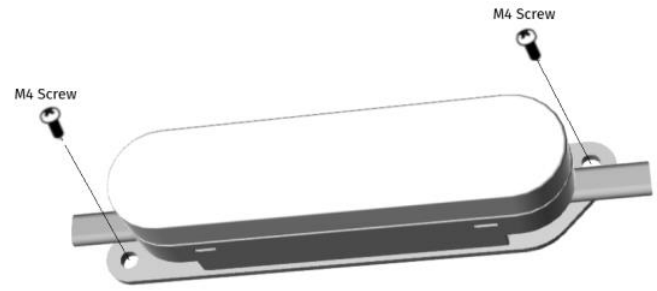

Bolts

If securing Smart Pixel Dots using bolts, ensure a locking nut is used that cannot become undone due to vibration.

DO NOT exert any tension on the cabling whilst tightening. ENTTEC recommend the use of washers.

Servicing, Inspection & Maintenance



- **Servicing, inspection & maintenance should only be carried out by qualified technicians familiar with all safety information within this document and the Smart PXL Dot system.**
- **Smart PXL Dots and accessories have no user serviceable parts. If your installation has become damaged, parts should be replaced.**



- **Power down the entire system and ensure a method is in place to stop the system from becoming energized during Servicing, Inspection & Maintenance.**

Key areas to examine during inspection:

- **Ensure all connectors are mated securely and show no sign of damage.**
- **Ensure all connectors show no sign of corrosion.**
- **Ensure all cabling has not obtained physical damage or been crushed.**
- **Ensure all Smart PXL Dots and accessories are secured to the surface and have been installed in accordance with the guidelines set out within the installation guide.**
- **Check for dust or dirt build up on the Smart PXL System and schedule cleaning if necessary. – Dirt or dust buildup can limit the ability for the Smart PXL Dot system to dissipate heat and can lead to damage.**

If deemed necessary for a Smart PXL Dot string or accessory to be replaced, it should be removed in a reverse order to installation as defined in this guide.

The replacement string or accessory should be an appropriate size and be installed in accordance with all steps within the installation guide.

To order replacement parts contact your reseller or ENTTEC directly.

Cleaning

Dust and dirt build up can limit the ability for the Smart PXL Dot system to dissipate heat resulting in damage. It's important that the Smart PXL Dot system is cleaned in a schedule fit for the environment it is installed within to ensure maximum product longevity.

Cleaning schedules will vary greatly depending on the operating environment of your Smart PXL Dots. Generally, the more extreme the environment, the shorter the interval between cleanings.



- **Before cleaning, power down the system and ensure a method is in place to stop the system from becoming energized until cleaning is complete.**



- **Do not use abrasive, corrosive or solvent-based cleaning products on a Smart PXL Dot system.**
- **Do not spray Smart PXL Dots or accessories with a high-pressure water jet.**

To clean an ENTTEC Smart PXL system, use low-pressure compressed air to remove dust, dirt and loose particles. If deemed necessary, wipe the Smart PXL Dots with a damp microfiber cloth.

A selection of environmental factors that may increase demand for frequent cleaning include:

- Use of stage fog, smoke or atmospheric devices.
- High airflow rates (i.e. in close proximity to air conditioning vents).
- High pollution levels or cigarette smoke.
- Airborne dust (from building work, the natural environment or pyrotechnic effects).

If any of these factors are present, inspect all elements of the system soon after installation to see whether cleaning is necessary, then check again at frequent intervals. This procedure will allow you to determine a reliable cleaning schedule for your installation.

Part Codes & Ordering Information

Smart PXL Dots

Product	SKU
Smart PXL-100x25 Dot	Refer to DATASHEET

Please contact ENTTEC team to discuss your customization need.

Smart PXL Dot Accessories

Product	SKU	
Smart PXL – Termination End Cap (pack of 5)	73015	
Smart PXL – 2m Male Cable	24V	73017
	48V	73021
Smart PXL – 2m Female Cable	24V	73018
	48V	73022
Smart PXL – Power Injector	24V	73019
	48V	73023
Smart PXL – 2m Extension Cable	24V	73020
	48V	73024

Please contact the ENTTEC team to discuss the customization options available.

enttec.com

MELBOURNE AUS / LONDON UK / RALEIGH-DURHAM USA

Due to constant innovation, information within this document is subject to change.