

BrightLink 1480Fi/1485Fi User's Guide

Contents

BrightLink 1480Fi/1485Fi User's Guide	13
Introduction to Your Projector	14
Projector Features.....	14
Product Box Contents.....	16
Additional Components	17
Optional Equipment and Replacement Parts.....	18
Warranty and Registration Information	19
Notations Used in the Documentation	20
Where to Go for Additional Information	20
Additional Projector Software and Manuals.....	20
Projector Part Locations	22
Projector Parts - Front/Side	23
Projector Parts - Top/Side	24
Projector Parts - Interface.....	25
Projector Parts - Base.....	26
Projector Parts - Control Panel	27
Projector Parts - Remote Control.....	28
Projector Parts - Interactive Pens	30
Projector Parts - Pen Stand (BrightLink 1485Fi).....	31
Projector Parts - Control Pad (BrightLink 1485Fi).....	32
Projector Parts - Touch Unit	33
Setting Up the Projector	35
Projector Placement.....	35
Projector Setup and Installation Options	36
Projection Distance.....	38
Removing and Attaching the Cable Cover.....	39
Projector Connections	39
Connecting to Computer Sources.....	40
Connecting to a Computer for USB Video and Audio.....	40
Connecting to a Computer for VGA Video.....	42

Connecting to a Computer for HDMI Video and Audio	42
Connecting to a Computer for Pen and Finger Use.....	43
Connecting a Computer to the Control Pad.....	44
Connecting to a Computer for Sound.....	45
Connecting to Video Sources	46
Connecting to an HDMI Video Source	46
Connecting to a Composite Video Source	47
Connecting to a Video Source for Sound	48
Connecting External Output Devices.....	48
Connecting to an External Computer Monitor	49
Connecting to an External HDMI Monitor.....	50
Connecting to External Speakers.....	50
Connecting a Microphone.....	51
Connecting to External USB Devices	52
USB Device Projection.....	52
Connecting a USB Device or Camera to the Projector	53
Connecting a USB Device to the Control Pad	53
Selecting the Connected USB Source	54
Disconnecting a USB Device From the Control Pad or Projector.....	55
Connecting to a Document Camera	55
Connecting a Printer to the Control Pad	56
Connecting Multiple Projectors of the Same Model	56
Multiple Projector Connection Menu Settings	58
Installing Batteries in the Remote Control	61
Installing Batteries in the Pens	62
Using the Projector on a Network	64
Wired Network Projection.....	64
Connecting to a Wired Network	65
Selecting Wired Network Settings	65
Wireless Network Projection	68
Installing the Wireless LAN Module	69
Connecting Directly to a Smartphone or Tablet	71
Using Quick Wireless Connection (Windows).....	74

Selecting Wireless Network Settings Manually.....	75
Wireless LAN Menu Settings	80
Selecting Wireless Network Settings in Windows.....	83
Selecting Wireless Network Settings on Mac	83
Setting Up Wireless Network Security	83
Wireless Network Projection from a Mobile Device or Windows Computer (Screen Mirroring).....	85
Screen Mirroring Restrictions	85
Selecting Screen Mirroring Settings	86
Connecting for Screen Mirroring with a Windows 8.x/Windows 10 Computer	88
Connecting for Screen Mirroring with Miracast	89
Setting Up Projector Network E-Mail Alerts	90
Network Projector E-mail Alert Messages	91
Setting Up Monitoring Using SNMP	91
Controlling a Networked Projector Using a Web Browser	92
Creating an Address Book	95
Using Crestron Connected	96
Setting Up Crestron Connected.....	97
Controlling a Networked Projector Using Crestron Connected.....	98
Registering a Digital Certificate on the Projector.....	100
Importing a Web Server Certificate Using the Projector Menus.....	100
Registering Digital Certificates from a Web Browser	101
Digital Certificate Types.....	102
Using Basic Projector Features	104
Turning On the Projector	104
Using the Home Screen.....	106
Turning Off the Projector	108
Selecting the Language for the Projector Menus.....	110
Setting the Date and Time.....	110
Image Shape.....	112
Correcting Image Shape with the Keystone Buttons.....	112
Correcting Image Shape with Quick Corner	115
Correcting Image Shape with Arc Correction.....	118
Correcting Image Shape with Point Correction.....	121

Correcting Image Shape with Corner Markers.....	123
Applying Saved Image Shape Settings	125
Resizing the Image with the Wide and Tele Buttons	125
Adjusting the Image Position	126
Focusing the Image.....	128
Remote Control Operation	131
Selecting an Image Source	132
Projection Modes	135
Changing the Projection Mode Using the Remote Control	135
Changing the Projection Mode Using the Menus.....	136
Image Aspect Ratio	137
Changing the Image Aspect Ratio	138
Available Image Aspect Ratios	138
Color Mode.....	139
Changing the Color Mode.....	139
Available Color Modes.....	140
Adjusting the Hue, Saturation, and Brightness	141
Adjusting Gamma.....	142
Adjusting the Image Resolution.....	144
Adjusting the Projector's Brightness Level	146
Constant Brightness Usage Hours	148
Turning On Dynamic Contrast.....	150
Controlling the Volume with the Volume Buttons.....	151
Inverting the Audio Channels	151
Selecting a Quick Startup Setting.....	152
Projecting a PC Free Presentation	154
Supported PC Free File Types	154
Starting a PC Free Slideshow.....	156
Starting a PC Free Movie Presentation	157
PC Free Display Options	159
Adjusting Projector Features	161
Shutting Off the Picture and Sound Temporarily	161
Stopping Video Action Temporarily	162

Zooming Into and Out of Images	163
Using Multiple Projectors (DuoLink)	164
Projector Identification System for Multiple Projector Control	164
Setting the Projector ID	164
Setting the Remote Control ID	165
Adjusting Color Uniformity	166
Blending the Image Edges	170
Matching the Image Colors	172
Adjusting the Black Level	174
Adjusting RGBCMY	178
Scaling an Image	180
Projecting Multiple Images Simultaneously	182
Input Sources for Split Screen Projection	184
Split Screen Projection Restrictions.....	185
Projector Security Features	185
Password Security Types	186
Setting a Password	186
Selecting Password Security Types.....	187
Entering a Password to Use the Projector.....	188
Saving a User's Logo Image to Display.....	189
Locking the Projector's Buttons	191
Unlocking the Projector's Buttons	192
Installing a Security Cable	193
Creating a User Pattern to Display	193
Saving Settings to Memory and Using Saved Settings	195
Copying Menu Settings Between Projectors	196
Saving Settings to a USB Flash Drive.....	197
Transferring Settings from a USB Flash Drive	198
Saving Settings to a Computer	199
Transferring Settings from a Computer	201
Scheduling Projector Events	202
Saving a Scheduled Event.....	203
Viewing Scheduled Events	205

Editing a Scheduled Event.....	206
Using the Interactive Features	209
Interactive Modes.....	209
Using the Projected Screen as a Whiteboard (Built-in Whiteboard Mode).....	210
Drawing on a Projected Image (Built-in Annotation Mode)	211
Controlling Computer Features from a Projected Screen (PC Interactive Mode).....	212
PC Interactive Mode System Requirements	214
Using the Interactive Pens	214
Using the Pens	215
Pen Calibration	217
Calibrating Automatically	218
Calibrating Manually	220
Using Finger Touch Interactivity	223
Touch Unit Safety Instructions.....	223
Performing Touch Unit Angle Adjustment.....	224
Calibrating for Finger Touch Interactivity	229
Using Finger Touch Operations.....	232
Using BrightLink with a Computer	235
Adjusting the Pen Operation Area	236
Easy Interactive Tools	238
Windows Pen Input and Ink Tools	238
Enabling Windows Pen Input and Ink Tools.....	239
Using Windows Pen Input and Ink Tools	240
Whiteboard Mode.....	242
Using the Whiteboard Toolbar	242
The Whiteboard Toolbar	243
Selecting Background Templates.....	246
Inserting and Working With Images.....	246
Selecting Whiteboard Settings	247
Selecting Basic Whiteboard Settings	248
Selecting Whiteboard Print Settings.....	249
Selecting Settings for Saving Whiteboard Pages.....	251
Selecting Settings for Emailing Whiteboard Pages	253

Selecting Settings for a Directory Server	254
Selecting a Networked Device Source	257
Saving Pages in Whiteboard Mode	257
Printing Whiteboard Pages.....	259
Emailing Whiteboard Pages	260
Using BrightLink Without a Computer	262
Using the Built-in Annotation Mode	262
Built-in Tools for Use Without a Computer.....	263
Controlling an Epson Document Camera	266
Splitting the Projected Image with Whiteboard Mode	267
Sharing the Projected Screen	268
Starting a Shared Screen Session.....	268
Using Interactive Features with Two Projectors (DuoLink).....	269
Adjusting the Menu Settings	270
Using the Projector's Menus.....	270
Image Quality Settings - Image Menu	272
Input Signal Settings - Signal I/O Menu.....	277
Installation Settings - Installation Menu	281
Display Settings - Display Menu.....	286
Feature Settings - Operation Menu	289
Administration Settings - Management Menu.....	293
Event ID Code List.....	299
Network Settings - Network Menu	302
Pen and Touch Setup Settings - Pen/Touch Menu.....	305
Interactive Settings - Interactive Menu	308
Multiple Projector Operation Settings - Multi-Projection Menu	311
Image Quality Memory Settings - Memory Menu	316
Setup Settings - ECO Menu	317
Initial Settings and Reset Options - Initial/All Settings Menu	319
Maintaining and Transporting the Projector	321
Projector Maintenance	321
Cleaning the Lens.....	321
Cleaning the Projector Case.....	322

Air Filter and Vent Maintenance	322
Cleaning the Air Filter and Vents	323
Replacing the Air Filter	327
Replacing the Remote Control Batteries	329
Replacing the Hard Pen Tips.....	331
Replacing the Soft Pen Tips	332
Updating the Firmware	335
Transporting the Projector.....	335
Solving Problems	336
Projection Problem Tips	336
Projector Light Status	337
Using the Projector Menu Displays	340
Solving Image or Sound Problems	341
Solutions When No Image Appears.....	341
Solutions When Image is Incorrect Using the USB Display Function	342
Solutions When "No Signal" Message Appears.....	343
Displaying From a PC Laptop	344
Displaying From a Mac Laptop	345
Solutions When "Not Supported" Message Appears	345
Solutions When Only a Partial Image Appears	345
Solutions When the Image is Not Rectangular	346
Solutions When the Image Contains Noise or Static	347
Solutions When the Image is Fuzzy or Blurry	348
Solutions When the Image Brightness or Colors are Incorrect	349
Solutions When an Afterimage Remains On the Projected Image.....	349
Solutions to Sound Problems	350
Solutions to Microphone Problems	351
Solving Projector or Remote Control Operation Problems	351
Solutions to Projector Power or Shut-Off Problems	351
Solutions to Remote Control Problems.....	352
Solutions to Password Problems	353
Solutions When a Battery Message Appears	354
Solving Network Problems	354

Solutions When Wireless Authentication Fails	354
Solutions When You Cannot Access the Projector Through the Web	355
Solutions When Network Alert E-Mails are Not Received.....	355
Solutions When the Image Contains Static During Network Projection	356
Solutions When You Cannot Connect Using Screen Mirroring.....	356
Solutions When the Image or Sound Contains Static When Using Screen Mirroring.....	356
Solutions When the Projected Screen is not Shared Correctly	357
Solving Interactive Problems.....	357
Solutions When the Interactive Pens Do Not Work.....	358
Solutions When the Interactive Pen Position Is Not Accurate.....	360
Solutions When the Interactive Pens Are Slow or Difficult to Use.....	361
Solutions When the Interactive Pens Cause Interference or Unwanted Effects	361
Solutions When Finger Touch Interactivity Does Not Work	361
Solutions When You Cannot Operate a Computer from the Projected Screen.....	363
Solutions for Problems With Capturing, Printing, Saving, or Scanning	363
Solutions for Problems with Whiteboard Mode	364
Where to Get Help (U.S. and Canada)	364
Technical Specifications	366
General Projector Specifications	366
Projector Light Source Specifications.....	368
Interactive Pen Specifications	368
Touch Unit Specifications	368
Remote Control Specifications	369
Projector Dimension Specifications.....	369
Projector Electrical Specifications	369
Projector Environmental Specifications.....	370
Projector Safety and Approvals Specifications.....	371
Safety and Approvals Specifications for Latin America	371
Supported Video Display Formats.....	372
USB Display System Requirements.....	375
Notices	376
Recycling (U.S. and Canada).....	376
Important Safety Information	376

Laser Safety Information	377
Laser Light Source Warning	380
Important Safety Instructions.....	380
Restriction of Use	385
List of Safety Symbols (corresponding to IEC60950-1 A2).....	385
FCC Compliance Statement.....	390
Binding Arbitration and Class Waiver	391
Trademarks	394
Copyright Notice.....	394
A Note Concerning Responsible Use of Copyrighted Materials.....	395
Copyright Attribution	395

BrightLink 1480Fi/1485Fi User's Guide

Welcome to the BrightLink 1480Fi/1485Fi *User's Guide*.

For a printable PDF copy of this guide, [click here](#).

Introduction to Your Projector

Refer to these sections to learn more about your projector and this manual.

[Projector Features](#)

[Notations Used in the Documentation](#)

[Where to Go for Additional Information](#)

[Additional Projector Software and Manuals](#)

[Projector Part Locations](#)

Projector Features

The BrightLink 1480Fi/1485Fi projector includes these special features:

Unique interactive functions

- Annotation with or without a computer
- Annotation with two pens at the same time (depending on interactive mode, connection method, and operating system)
- Enhanced Easy Interactive toolbar for Windows and Mac
- Touch-based interactivity for as many as six users (Touch Unit required)
- Control your computer from the projected screen
- Print, save, and send your presentations without a computer
- Scan and display content from a connected scanner
- Import content from a USB drive
- Share your projected content with tablets, smartphones, and other devices

Bright, high-resolution projection system

- Up to 5000 lumens of color brightness (color light output) and white brightness (white light output)

Note: Color brightness (color light output) and white brightness (white light output) will vary depending on usage conditions. Color light output measured in accordance with IDMS 15.4; white light output measured in accordance with ISO 21118.

- 1080p native resolution (Pixel shifting technology achieves Full HD resolution on screen.)

Flexible connectivity

- Three HDMI ports for computer or video device connection
- Plug-and-play USB projection and audio for instant setup
- HDBaseT control pad with single connection to projector for simplified cabling and installation (BrightLink 1485Fi)
- Wired and wireless network support for projection
- Screen mirroring to connect your mobile device wirelessly using Miracast technology
- Projector monitoring and control via remote network computer
- PC Free photo slide shows via connected USB memory devices or Epson document camera (only on models that support the slide show function)
- One HDMI port for connecting an external display or linking another compatible projector (BrightLink 1485Fi)
- Use Epson iProjection (Windows/Mac) to simultaneously project up to four images from network computers or mobile devices
- Projection from an iOS device, Android device, or Chromebook with the free Epson iProjection app; visit epson.com/iprojection (U.S.) or epson.ca/iprojection (Canada) for more information

Innovative display and operation features

- Long-life laser light source
- Support for side-by-side projector mounting with continuous annotation (BrightLink 1485Fi)
- High digital zoom ratio for larger images in shorter projection distances
- 2,500,000:1 contrast ratio and Dynamic Contrast control for sharp, detailed images
- Built-in closed captioning decoder
- Powerful 16 W speaker system with audio out port for connecting external speakers
- Epson's Direct Power On and Auto Power On features for quick and easy setup
- Support for Crestron RoomView network monitoring systems
- Network message broadcast system to project timely messages to all networked projectors

[Product Box Contents](#)

[Additional Components](#)

[Optional Equipment and Replacement Parts](#)

[Warranty and Registration Information](#)

Parent topic: [Introduction to Your Projector](#)

Product Box Contents

Save all the packaging in case you need to ship the projector. Always use the original packaging (or equivalent) when shipping.

Make sure your projector box included all of these parts:

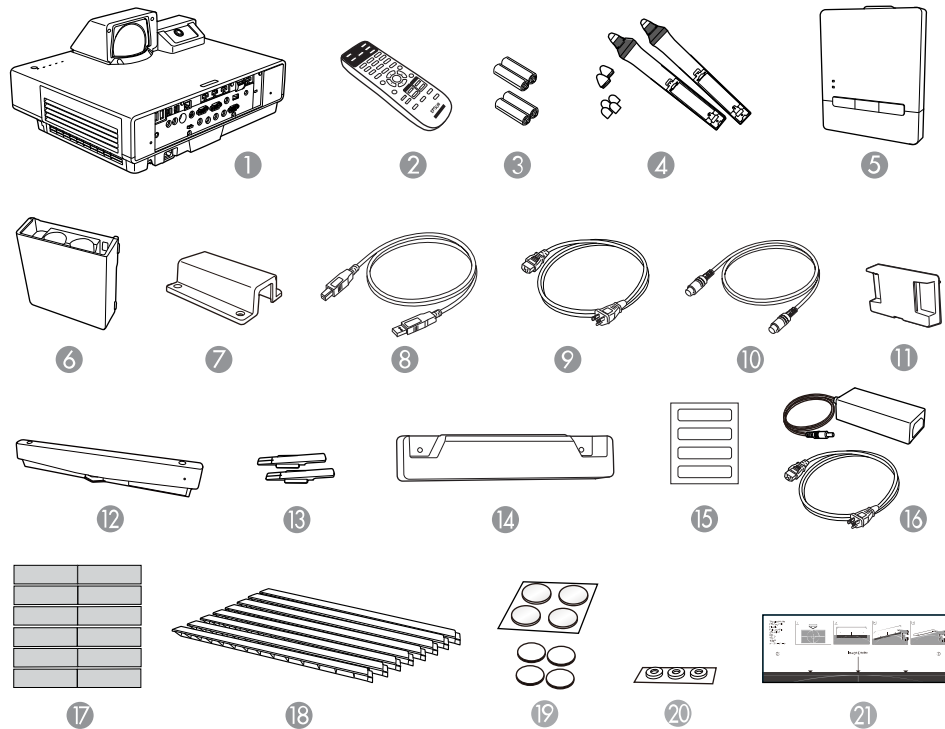

- 1 Projector
- 2 Remote control
- 3 Remote control and pen batteries (2 AA rechargeable and 2 AA alkaline; included battery charger not shown)
- 4 Interactive pens and replacement pen tips (4 soft tips, 2 hard tips)

- 5 Control pad (BrightLink 1485Fi)
- 6 Pen stand (BrightLink 1485Fi)
- 7 Control pad AC adapter holder (BrightLink 1485Fi)
- 8 6 ft (1.8 m) USB cable
- 9 Power cord
- 10 Touch Unit connection cable (included with BrightLink 1485Fi; optional for BrightLink 1480Fi)
- 11 Lens cap
- 12 Touch Unit (included with BrightLink 1485Fi; optional for BrightLink 1480Fi)
- 13 Markers for Touch Unit setup (included with BrightLink 1485Fi; optional for BrightLink 1480Fi)
- 14 Cable cover
- 15 Labels (4)
- 16 Control pad AC adapter and power cord
- 17 Tape for securing markers (included with BrightLink 1485Fi; optional for BrightLink 1480Fi)
- 18 Infrared deflectors (12) (included with BrightLink 1485Fi; optional for BrightLink 1480Fi)
- 19 Auto image adjustment markers and magnets
- 20 Spacers for screw holes
- 21 Touch Unit mounting template (included with BrightLink 1485Fi; optional for BrightLink 1480Fi)

Parent topic: [Projector Features](#)

Additional Components

Depending on how you plan to use the projector, you may need to obtain additional components.

Note: To connect a Mac that does not include a compatible video output port, you need to obtain an adapter that allows you to connect to an input port on the projector. Contact Apple for compatible adapter options. To connect a smartphone or tablet, you may need to obtain an adapter that allows you to connect to the projector. This allows you to mirror your smartphone or tablet screens, watch movies, and more. Contact your device manufacturer for compatible adapter options.

Unless listed as available from Epson in this table, see your local computer or electronics dealer for purchase information.

Signal or connection type	Additional component necessary
Composite video	RCA-style video or A/V cable
HDMI	Compatible HDMI cable Available for purchase from Epson or an authorized Epson reseller. Note: Older Mac computers (2009 and earlier) may not support HDMI audio.
Audio from certain ports	Commercially available audio cable compatible with your device
VGA	To connect a computer through its VGA port to the projector's VGA video port, you need a VGA computer cable.
Multiple BrightLink projectors	To sync additional BrightLink projectors together, you need a stereo mini cable (commercially available) or the remote control cable set (ELPKC28). Available for purchase from Epson or an authorized Epson reseller.

Parent topic: [Projector Features](#)

Optional Equipment and Replacement Parts

You can purchase screens, other optional accessories, and replacement parts from an Epson authorized reseller. To find the nearest reseller, call 800-GO-EPSON (800-463-7766) in the U.S. or 800-807-7766 in Canada. Or you can purchase online at epsonstore.com (U.S. sales) or epsonstore.ca (Canadian sales).

Epson offers the following optional accessories and replacement parts for your projector:

Option or part	Part number
Replacement air filter (ELPAF56)	V13H134A56
Ultra-short throw wall mount (ELPMB62)	V12HA06A05
Finger Touch Unit (ELPFT01)	V12H007A23
Wireless LAN module (ELPAP11)	V12H005A02
Epson DC-07 document camera (ELPDC07)	V12H759020
Epson DC-11 document camera (ELPDC11)	V12H377020
Epson DC-12 document camera (ELPDC12)	V12H594020

Option or part	Part number
Epson DC-13 document camera (ELPDC13)	V12H757020
Epson DC-20 document camera (ELPDC20)	V12H500020
Epson DC-21 document camera (ELPDC21)	V12H758020
PowerLite Pilot 3 connection and control box (ELPCB03)	V12H927020
Active speakers (ELPSP02)	V12H467020
Additional interactive pen A (ELPPN05A) (orange)	V12H773010
Additional interactive pen B (ELPPN05B) (blue)	V12H774010
Replacement set of hard pen tips (ELPPS03)	V12H775010
Replacement set of soft pen tips (ELPPS04)	V12H776010
Remote control cable set (ELPKC28)	V12H005C28
100 inch (254 cm) 16:9 whiteboard (DaLite)	V12H006A01
100 inch (254 cm) 16:9 whiteboard (MooreCo)	V12H006A02
Touch Unit mounting bracket (ELPMB63)	V12HA05A09
USB extension cable (ELPKC31)	V12H525001
PixiePlus control system	ELPSP10

In addition to the accessories listed above, 1-year and 2-year extended service plans are available.

Parent topic: [Projector Features](#)

Related references

[Where to Get Help \(U.S. and Canada\)](#)

Warranty and Registration Information

Your projector comes with a basic warranty that lets you project with confidence. For details, see the warranty that came with your projector.

In addition, Epson offers free Extra Care Road Service. In the unlikely event of an equipment failure, you won't have to wait for your unit to be repaired. Instead, Epson will ship you a replacement unit anywhere in the United States, Canada, or Puerto Rico. See the Extra Care Road Service brochure for details.

Note: Availability varies by region.

Register your product online at this site: epson.com/webreg.

Registering also lets you receive special updates on new accessories, products, and services.

Parent topic: [Projector Features](#)

Notations Used in the Documentation

Follow the guidelines in these notations as you read your documentation:

- **Warnings** must be followed carefully to avoid bodily injury.
- **Cautions** must be observed to avoid damage to your equipment.
- **Notes** contain important information about your projector.
- **Tips** contain additional projection information.

Parent topic: [Introduction to Your Projector](#)

Where to Go for Additional Information

Need quick help on using your projector? Here's where to look for help:

- **Guidance** icon in the Other Tools menu of the interactive toolbar
Select the  **Guidance** icon to display the help screen for toolbar functions.
- epson.com/support (U.S.), epson.ca/support (Canada), or latin.epson.com/support (Caribbean)
View FAQs (frequently asked questions) and e-mail your questions to Epson technical support 24 hours a day.
- If you still need help after checking this manual and any other sources listed here, you can use the Epson PrivateLine Support service to get help fast. For details, see "Where to Get Help."

Parent topic: [Introduction to Your Projector](#)

Related references

[Where to Get Help \(U.S. and Canada\)](#)

Additional Projector Software and Manuals

After connecting and setting up the projector, install the projector software as necessary. You may need to install it from a software CD, if included, or download the software and manuals as necessary.

You can install the projector software programs listed here and view their manuals for instructions on using them.

Note: If you still need help after checking this manual and the sources listed here, you can use the Epson PrivateLine Support service to get help fast. For details, see "Where to Get Help."

Projector software	Manual	Description
Epson Projector Management (Windows only)	<i>Epson Projector Management Operation Guide</i>	Lets you monitor and control your projector through the network. You can download the latest software and documentation from the Epson web site. Go to epson.com/support (U.S.) or epson.ca/support (Canada) and select your projector.
Epson iProjection (Windows/Mac)	<i>Epson iProjection Operation Guide (Windows/Mac)</i>	Lets you project the computer screens of users over a network. You can download the latest software and documentation from the Epson web site. Go to epson.com/support (U.S.) or epson.ca/support (Canada) and select your projector.
Epson iProjection app	Instructions are included with the app	Lets you project from an iOS device, Android device, or Chromebook if your projector is connected to a network that includes a wireless access point. Visit epson.com/iprojection (U.S.) or epson.ca/iprojection (Canada) for more information.
Easy Interactive Tools (Windows/Mac)	<i>Easy Interactive Tools Operation Guide</i>	Lets you use your computer to interactively draw on projected images (Mac users also need to install the Easy Interactive Driver) You can download the latest software and documentation from the Epson web site. Go to epson.com/support (U.S.) or epson.ca/support (Canada) and select your projector.
—	<i>Open Source Software License</i>	You can download this document from the Epson web site. Go to epson.com/support (U.S.) or epson.ca/support (Canada) and select your projector.

Parent topic: [Introduction to Your Projector](#)

Projector Part Locations

Check the projector part illustrations to learn about the parts on your projector.

Note: The BrightLink 1485Fi is shown in most illustrations in this manual, unless noted otherwise.

[Projector Parts - Front/Side](#)

[Projector Parts - Top/Side](#)

[Projector Parts - Interface](#)

[Projector Parts - Base](#)

[Projector Parts - Control Panel](#)

[Projector Parts - Remote Control](#)

[Projector Parts - Interactive Pens](#)

[Projector Parts - Pen Stand \(BrightLink 1485Fi\)](#)

[Projector Parts - Control Pad \(BrightLink 1485Fi\)](#)

[Projector Parts - Touch Unit](#)

Parent topic: [Introduction to Your Projector](#)

Projector Parts - Front/Side

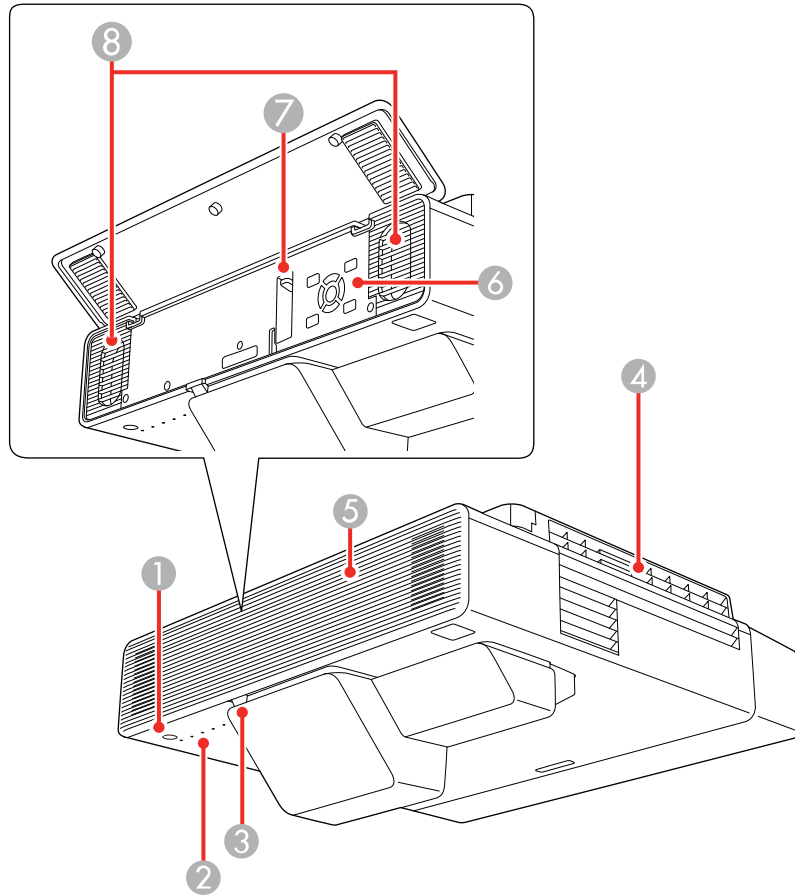

- 1 Power button
- 2 Status lights
- 3 Remote control receiver
- 4 Exhaust vent
- 5 Front cover
- 6 Control panel

7 Focus lever

8 Speakers

Parent topic: [Projector Part Locations](#)

Related references

[Projector Light Status](#)

Projector Parts - Top/Side

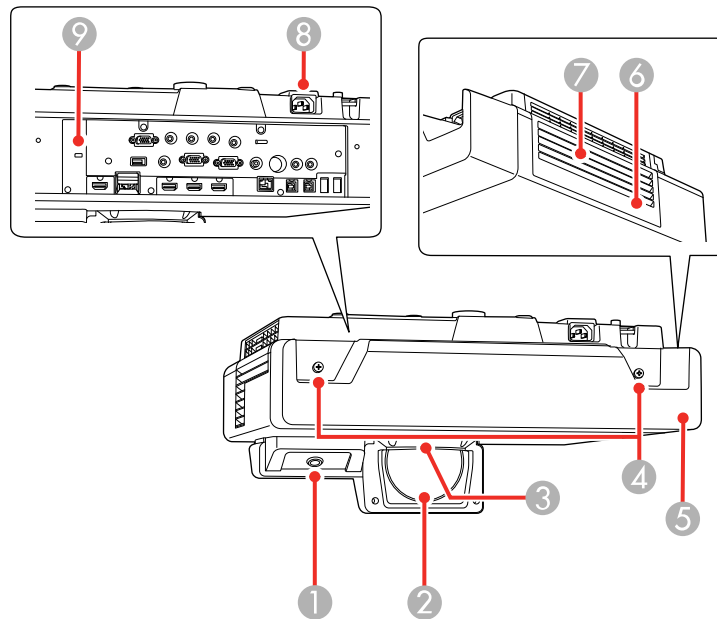

1 Interactive pen receiver

2 Projection lens

3 Remote receiver

4 Cable cover screws

5 Cable cover

6 Air filter cover

- 7 Air intake vent (air filter)
- 8 Power inlet
- 9 Security cable installation slot

Parent topic: [Projector Part Locations](#)

Projector Parts - Interface

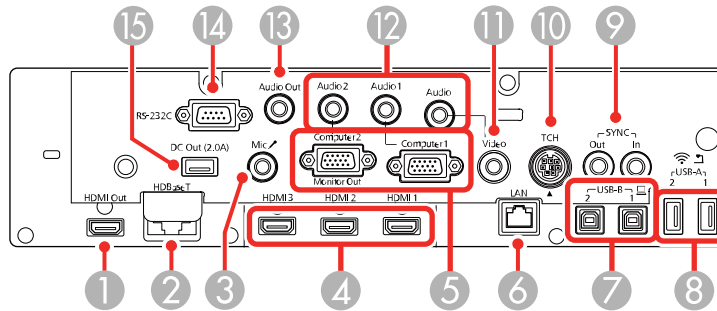

- 1 **HDMI Out** port
- 2 **HDBaseT** port (BrightLink 1485Fi)
- 3 **Mic** port
- 4 **HDMI1/HDMI2/HDMI3** ports
- 5 **Computer1/Computer2 Monitor Out** ports
- 6 **LAN** port
- 7 **USB-B1/USB-B2** ports
- 8 **USB-A1/USB-A2** ports
- 9 **SYNC In/Out** ports
- 10 **TCH** port for the Touch Unit connection cable
- 11 **Video** port
- 12 **Audio/Audio1/Audio2** ports
- 13 **Audio Out** port

- 14 **RS-232C** port
- 15 **DC Out (2.0A)** port

Parent topic: [Projector Part Locations](#)

Related concepts

[Projector Connections](#)

Projector Parts - Base

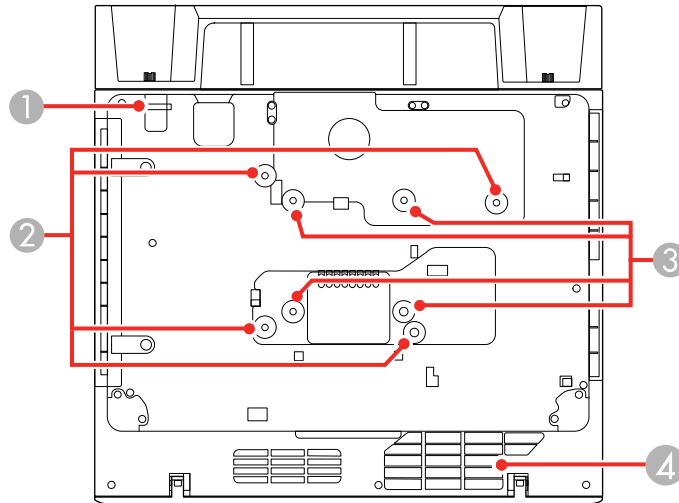



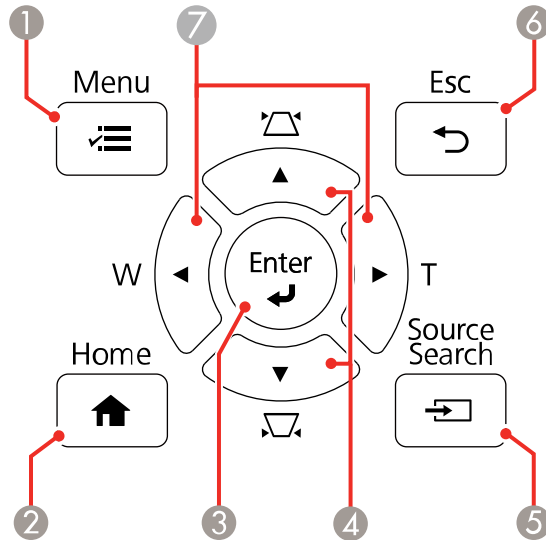

- 1 Security cable attachment point
- 2 Wall mounting plate holes (4)
- 3 VESA-compatible mount fixing points (4)
- 4 Air intake vent

Parent topic: [Projector Part Locations](#)

Projector Parts - Control Panel



- 1  **Menu** button (accesses projector menu system)
- 2  **Home** button (accesses projector Home screen)
- 3  **Enter** button (selects options)
- 4 Vertical keystone adjustment buttons (display the adjustment screen and adjust screen shape) and arrow buttons
- 5  **Source Search** button (searches for connected video sources)
- 6  **Esc** button (cancels/exits functions)
- 7 **W/T** (Wide/Tele) buttons (adjust projected image size) and arrow buttons

Parent topic: [Projector Part Locations](#)

Projector Parts - Remote Control

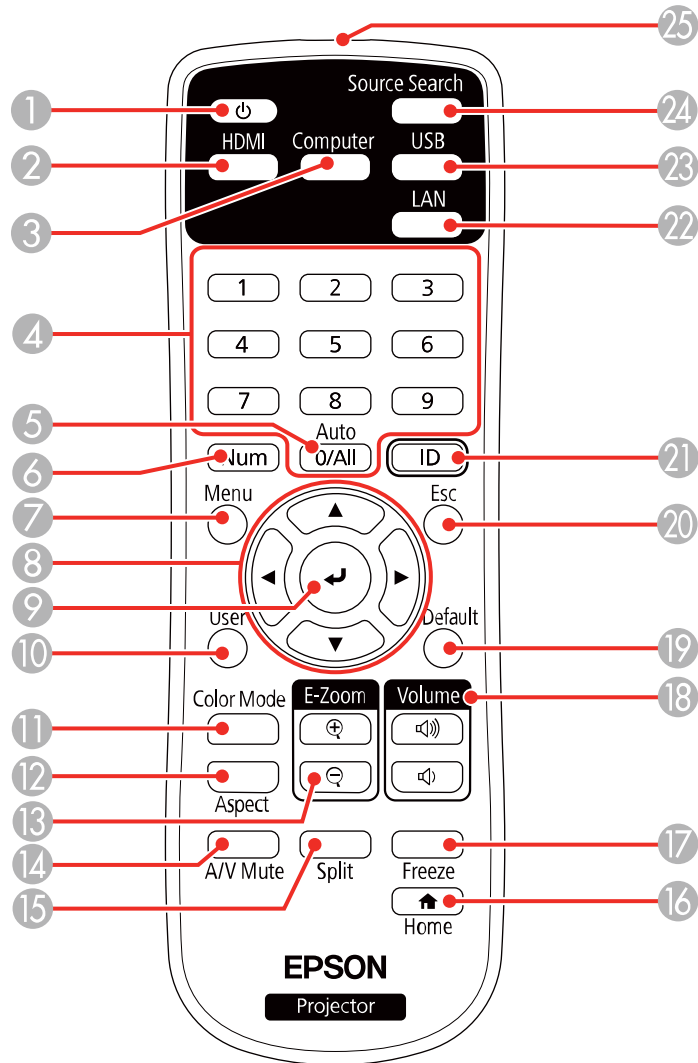

- 1 Power button
- 2 **HDMI** button (cycles through connected HDMI sources)

- 3 **Computer** button
- 4 Numeric buttons
- 5 **Auto** button (automatically adjusts position, tracking, and sync settings)
- 6 **Num** button (when held down, switches numeric buttons to number function)
- 7 **Menu** button (accesses projector menu system)
- 8 Arrow buttons (move through on-screen options)
- 9 ↵ Enter button (selects options)
- 10 **User** button (customizable for different functions)
- 11 **Color Mode** button (selects display modes)
- 12 **Aspect** button (selects the image aspect ratio)
- 13 **E-Zoom +/-** buttons (zoom into and out of the image)
- 14 **A/V Mute** button (turns off picture and sound)
- 15 **Split** button (splits the screen between two image sources)
- 16 🏠 **Home** button (accesses projector Home screen)
- 17 **Freeze** button (stops video action)
- 18 **Volume** up/down buttons (adjust speaker volume)
- 19 **Default** button (resets the selected setting to its default value)
- 20 **Esc** button (cancels/exits functions and controls wireless mouse functions)
- 21 **ID** button (selects a projector to use with the remote control)
- 22 **LAN** button (connects to a network source)
- 23 **USB** button (cycles through connected USB sources)
- 24 **Source Search** button (searches for connected sources)
- 25 Remote control emitter

Parent topic: [Projector Part Locations](#)

Projector Parts - Interactive Pens

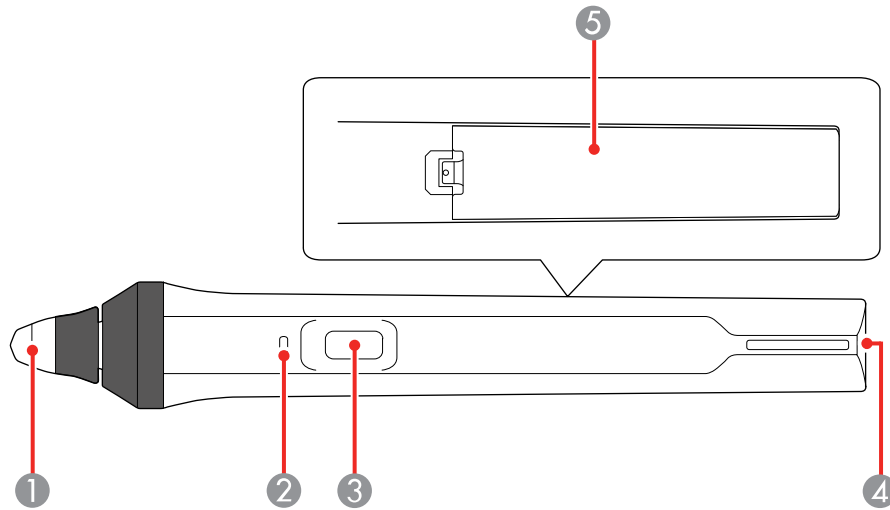

- 1 Pen tip
- 2 Battery light
- 3 Function button
- 4 Attachment for optional strap or cord
- 5 Battery cover

Parent topic: [Projector Part Locations](#)

Projector Parts - Pen Stand (BrightLink 1485Fi)

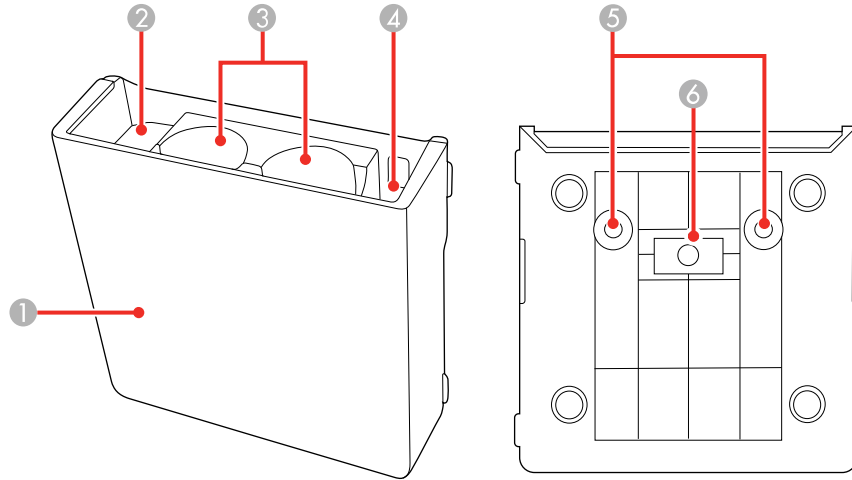

- 1 Front cover
- 2 Pen tip storage area
- 3 Pen storage area
- 4 Battery storage area
- 5 Wall mounting holes
- 6 Installation magnet

Parent topic: [Projector Part Locations](#)

Projector Parts - Control Pad (BrightLink 1485Fi)

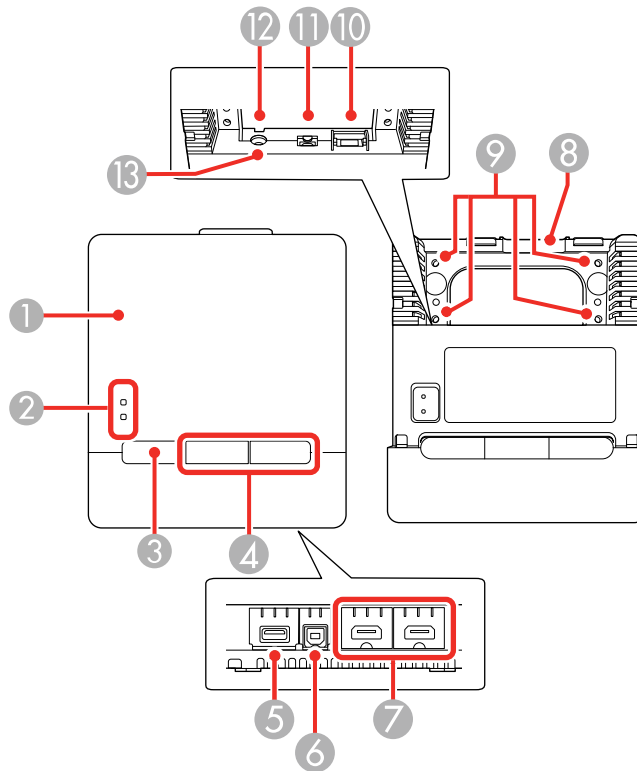

- 1 Front cover
- 2 Indicator lights
- 3 Power button
- 4 **HDMI1/HDMI2** buttons
- 5 **USB-A** port
- 6 **USB-B** port
- 7 **HDMI1/HDMI2** input ports
- 8 Upper cable path
- 9 Mounting screw holes

- 10 **HDBaseT** port
- 11 **USB-B** port (to projector)
- 12 Power inlet cable path
- 13 Power inlet

Parent topic: [Projector Part Locations](#)

Projector Parts - Touch Unit

The Touch Unit is included with the BrightLink 1485Fi and optional for the BrightLink 1480Fi.

Front/Top

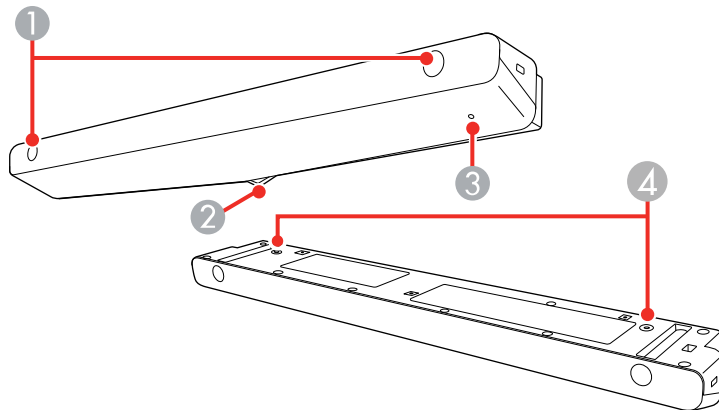

Back

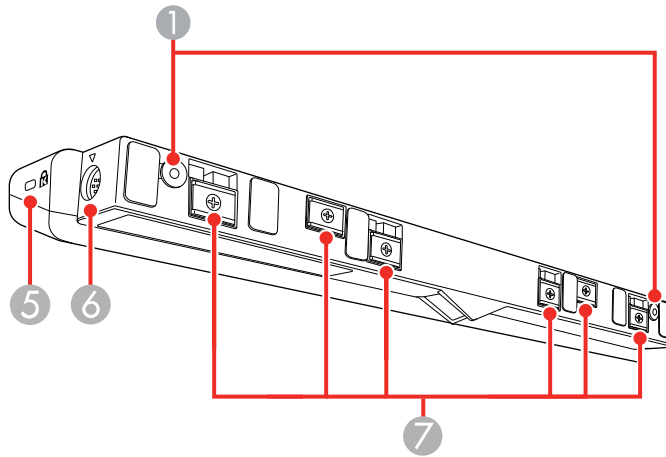

- 1 Installation screw holes
- 2 Laser diffusion port
- 3 Indicator light
- 4 Installation screw holes
- 5 Security cable installation slot
- 6 **TCH** port
- 7 Installation magnets

Parent topic: [Projector Part Locations](#)

Setting Up the Projector

Follow the instructions in these sections to set up your projector for use.

[Projector Placement](#)

[Removing and Attaching the Cable Cover](#)

[Projector Connections](#)

[Installing Batteries in the Remote Control](#)

[Installing Batteries in the Pens](#)

Projector Placement

Your ultra-short throw projector is designed to be installed on a wall (with a wall mount) or vertically on a table (with a table mount) to create an interactive tabletop workspace.

You can also place the projector on a flat surface such as a desk or table to project in a portable setup.

Note: A Touch Unit is optional for the BrightLink 1480Fi and must be installed for finger touch operation. Finger touch operation is available only if the projector is installed on a wall (with a wall mount) and projecting from the front of the wall, or vertically on a table (with a table mount) and projecting from the top of the table.

Keep these considerations in mind as you select a projector location:

- Follow the instructions in the online *Installation Guide* to install the projector.
- Leave plenty of space around and under the projector for ventilation, and do not place it on top of or next to anything that could block the vents.
- If you are using the projector at altitudes above 4921 feet (1500 m), set the **High Altitude Mode** setting to **On** in the projector's Installation menu to ensure the projector's internal temperature is regulated properly.
- Position the projector within reach of a grounded electrical outlet or extension cord.
- If installing vertically on a table, a commercially available mount compatible with the VESA Mounting Interface Standard (100 x 100 mm) is required.
- If installing on a wall, the wall mount (V12HA06A05) is required.
- If the projector is not mounted, place it on a sturdy, level surface.
- For finger touch, make sure the projection surface is flat, smooth, and unwarped with no more than 0.2 inch (5 mm) of unevenness in any direction.

- Place the projector so it squarely faces the screen, not at an angle. If you cannot install the projector squarely facing the screen, correct any resulting image distortion using the projector controls.
- Try not to set up the projector in locations subject to high humidity and dust, or in locations subject to smoke from fires or tobacco smoke.

[Projector Setup and Installation Options](#)

[Projection Distance](#)

Parent topic: [Setting Up the Projector](#)

Projector Setup and Installation Options

You can set up or install your projector in the following ways:

Mounted on the wall or ceiling

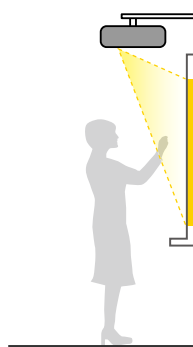

Mounted vertically on a table to create an interactive workspace

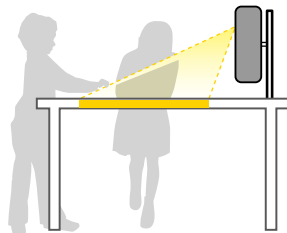

Mounted on the wall or ceiling and projecting from behind a translucent screen (interactive features not supported)

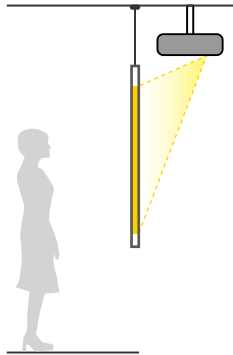

Mounted vertically and projecting from underneath a table (interactive features not supported)

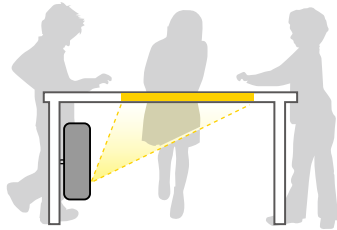

Front projection from a table or portable cart (finger touch not supported)

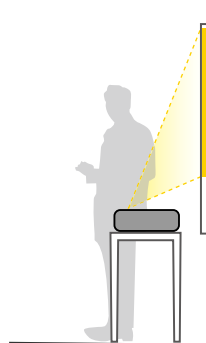

Rear projection from a table or portable cart behind a translucent screen (interactive features not supported)

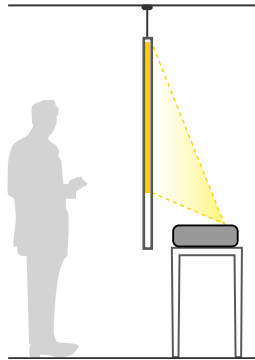

Wherever you set up the projector, make sure to position it squarely in front of the screen, not at an angle.

If you place the projector vertically, turn on the **Vertical Installation** setting in the projector's Installation menu.

If you install the projector to a fixed location, turn on the **Fixed Installation** setting in the projector's Installation menu.

If you project from a table or portable cart, be sure to select the correct **Projection** option in the projector's menu system.

Note: You cannot use the interactive pens or finger touch when projecting from behind a screen or under a table.

Parent topic: [Projector Placement](#)

Projection Distance

The distance at which you place the projector from the screen determines the approximate size of the image. The image size increases the farther the projector is from the screen, but can vary depending on the zoom factor, aspect ratio, and other settings.

Refer to the tables in the online *Installation Guide* to determine approximately how far to place the projector from the screen based on the size of the projected image. (Conversion figures may have been rounded up or down.) You can also use the Projection Distance Calculator [here](#) (U.S.), [here](#) (Canada), or [here](#) (Caribbean).

Parent topic: [Projector Placement](#)

Removing and Attaching the Cable Cover

Before you can connect equipment to your projector, you need to remove the cable cover.

1. Loosen both of the screws securing the cable cover and lift off the cable cover.

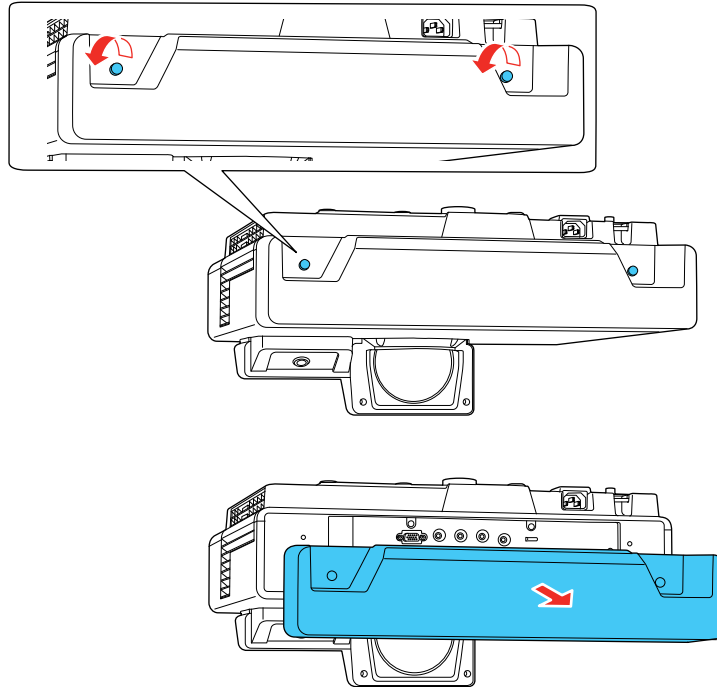

To attach the cable cover, replace the cable cover and tighten the cable cover screws.

Parent topic: [Setting Up the Projector](#)

Projector Connections

See these sections to connect the projector to a variety of projection sources.

Caution: If you will use the projector at altitudes above 4921 feet (1500 m), turn on **High Altitude Mode** to ensure the projector's internal temperature is regulated properly.

[Connecting to Computer Sources](#)
[Connecting to Video Sources](#)
[Connecting External Output Devices](#)
[Connecting a Microphone](#)
[Connecting to External USB Devices](#)
[Connecting to a Document Camera](#)
[Connecting a Printer to the Control Pad](#)
[Connecting Multiple Projectors of the Same Model](#)

Parent topic: [Setting Up the Projector](#)

Related references

[Additional Components](#)

[Installation Settings - Installation Menu](#)

Connecting to Computer Sources

Follow the instructions in these sections to connect a computer to the projector.

[Connecting to a Computer for USB Video and Audio](#)
[Connecting to a Computer for VGA Video](#)
[Connecting to a Computer for HDMI Video and Audio](#)
[Connecting to a Computer for Pen and Finger Use](#)
[Connecting a Computer to the Control Pad](#)
[Connecting to a Computer for Sound](#)

Parent topic: [Projector Connections](#)

Connecting to a Computer for USB Video and Audio

If your computer meets the system requirements, you can send video and audio output to the projector through the computer's USB port (preferably USB 2.0). Connect the projector to your computer using a USB cable.

Note: This also lets you use the interactive pens with your computer. You need to change the **USB Display** setting to **On** in the projector's Signal I/O menu before you can project through the USB port. Note that using USB Display will slow interactive pen function. For the best performance, VGA or HDMI connections are recommended.

Note: A USB connection may cause a delay for content requiring high bandwidth, such as movies. An HDMI connection is recommended for projecting movies, video games, and other home entertainment content.

1. Turn on your computer.
2. Connect the cable to your projector's **USB-B1** port.

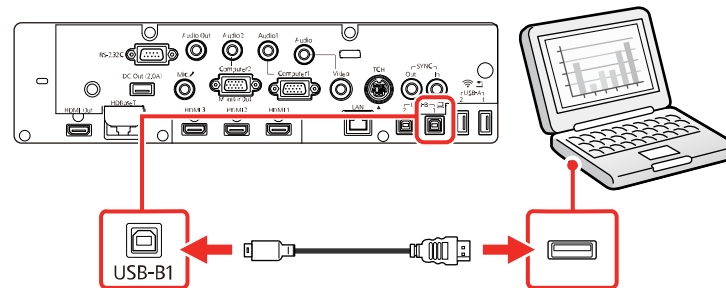

Note: If you use a USB hub, the connection may not operate properly. Connect the USB cable directly to the projector. When using the control pad (BrightLink 1485Fi), the projector cannot detect the image signal input from the projector's USB-B port. Connect the USB cable to the control pad.

3. Connect the other end to any available USB port on your computer.
4. To use USB Display, do one of the following:
 - **Windows 10/Windows 8.x:** Click **EPSON_PJ_UD** in the upper right-corner, then select **Run EMP_UDSE.exe** in the dialog box that appears to install the Epson USB Display software.
 - **Windows 7/Windows Vista:** Select **Run EMP_UDSE.exe** in the dialog box that appears to install the Epson USB Display software.
 - **Mac:** The USB Display setup folder appears on your screen. Select **USB Display Installer** and follow the on-screen instructions to install the Epson USB Display software.

Follow any on-screen instructions. You need to install this software only the first time you connect the projector to the computer.

The projector displays the image from your computer's desktop and outputs sound, if your presentation contains audio.

Parent topic: [Connecting to Computer Sources](#)

Related references

[Input Signal Settings - Signal I/O Menu](#)

Connecting to a Computer for VGA Video

You can connect the projector to your computer using a VGA computer cable.

Note: To connect a Mac that does not include a compatible video output port, you need to obtain an adapter that allows you to connect to an input port on the projector. Contact Apple for compatible adapter options. To connect a smartphone or tablet, you may need to obtain an adapter that allows you to connect to the projector. This allows you to mirror your smartphone or tablet screens, watch movies, and more. Contact your device manufacturer for compatible adapter options.

Note: To project an image source connected to the **Computer2/Monitor Out** port, set **Monitor Out Port** to **Computer2** in the projector's Signal I/O menu.

1. If necessary, disconnect your computer's monitor cable.
2. Connect the VGA computer cable to your computer's monitor port.
3. Connect the other end to a **Computer** port on the projector.

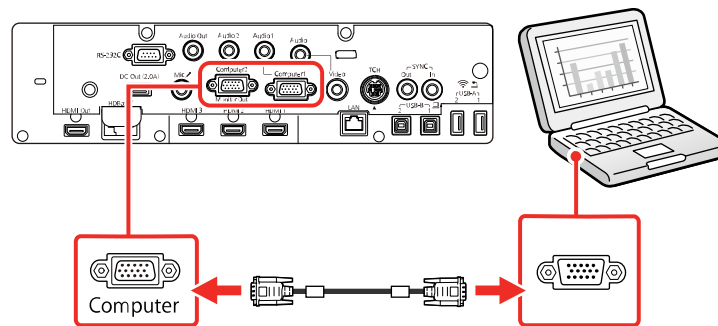

4. Tighten the screws on the VGA connector.

Parent topic: [Connecting to Computer Sources](#)

Connecting to a Computer for HDMI Video and Audio

If your computer has an HDMI port, you can connect it to the projector using an optional HDMI cable.

1. Connect the USB cable to your projector's **USB-B1** port.

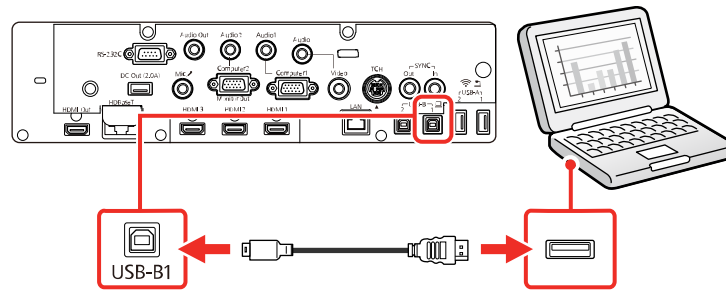

Note: If your computer is connected to the projector's **HDMI3** port, connect the USB cable to the projector's **USB-B2** port. You can change the HDMI port associated with the USB-B2 port by changing the **USB-B2** setting in the projector's **Pen/Touch > PC Interactivity** menu.

2. Connect the other end to any available USB port on your computer.

Parent topic: [Connecting to Computer Sources](#)

Related references

[Pen and Touch Setup Settings - Pen/Touch Menu](#)

Connecting a Computer to the Control Pad

If your computer has an HDMI port, you can connect it to the projector's control pad (BrightLink 1485Fi) using an HDMI cable.

Note: To connect a Mac that includes only a Mini DisplayPort, Thunderbolt port, or Mini-DVI port for video output, you need to obtain an adapter that allows you to connect to the projector's HDMI port. Contact Apple for compatible adapter options. Older Mac computers (2009 and earlier) may not support audio through the HDMI port.

1. Turn on your projector and computer, if necessary.
2. Enable **Connect ELPHD02** in the HDBaseT settings of the projector's Signal I/O menu.

3. Connect an HDMI cable to the **In1** or **In2** port on the bottom of the control pad, then connect the other end of the cable to any available HDMI port on your computer.

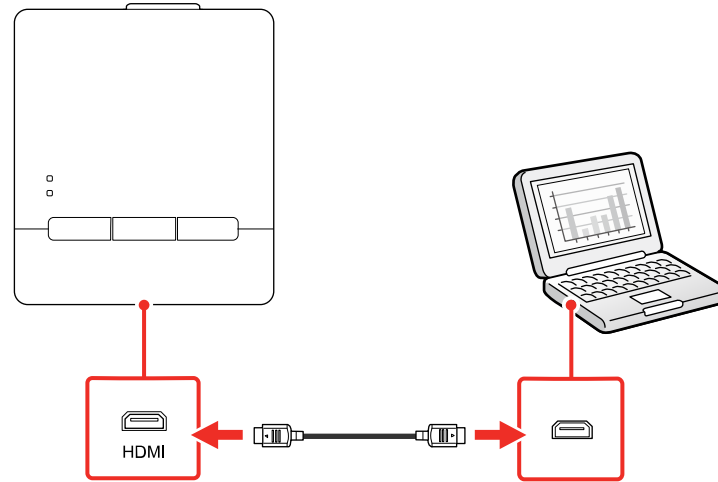

4. Press the **1** or **2** button on the control pad to select the port your computer is connected to.
The projector switches the input source to **HDBaseT**, displays the image from your computer's desktop, and outputs sound, if your presentation contains audio.
5. If you want to operate your computer from the projected screen using the interactive pens or your fingers, connect the USB cable to the **USB-B** port on the bottom of the control pad and any available USB port on your computer.

Parent topic: [Connecting to Computer Sources](#)

Connecting to a Computer for Sound

If your computer presentation includes sound and you did not connect it to a projector port that receives audio signals, you can still play sound through the projector's speaker system. Just connect an optional 3.5 mm stereo mini-jack audio cable as described here.

Note: Make sure the audio cable you use is labeled "No resistance."

1. Connect the audio cable to your laptop's headphone or audio-out jack, or your desktop's speaker or audio-out port.

2. Connect the other end to the **Audio** port that corresponds to the **Computer** port you are using.

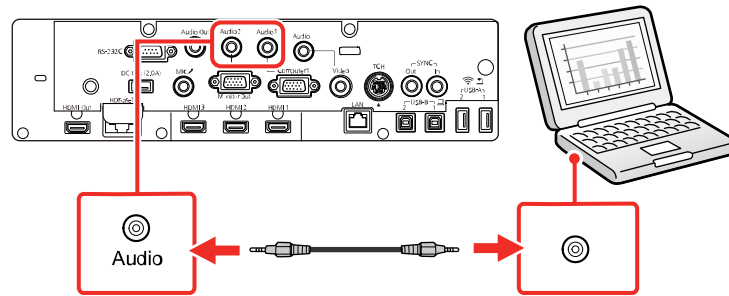

Parent topic: [Connecting to Computer Sources](#)

Connecting to Video Sources

Follow the instructions in these sections to connect video devices to the projector.

[Connecting to an HDMI Video Source](#)

[Connecting to a Composite Video Source](#)

[Connecting to a Video Source for Sound](#)

Parent topic: [Projector Connections](#)

Connecting to an HDMI Video Source

If your video source has an HDMI port, you can connect it to the projector using an optional HDMI cable. The HDMI connection provides the best image quality. You can also connect your video source to an HDMI port on the control pad (BrightLink 1485Fi).

Caution: Do not turn on the video source before connecting it to the projector. Doing so could damage the projector.

Note: If you are connecting a video source to an HDMI port on the control pad, enable **Connect ELPHD02** in the HDBaseT settings of the projector's Signal I/O menu.

1. Connect the HDMI cable to your video source's HDMI output port.

2. Connect the other end to one of the projector's HDMI ports.

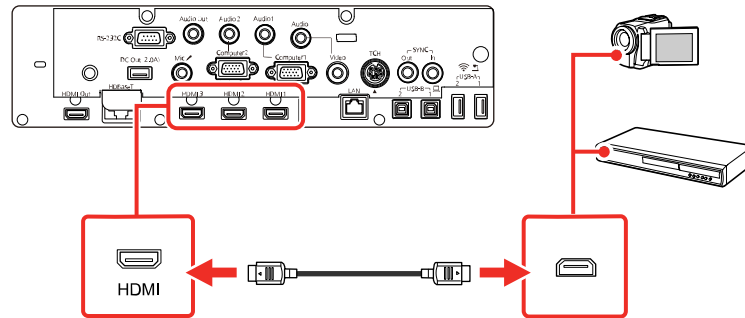

Note: If you have problems hearing audio through the HDMI connection, you can use one of the projector's audio ports instead to play sound. Connect one end of an optional 3.5 mm stereo mini-jack audio cable to one of the projector's audio ports and the other end to your computer's audio out port. Then select the audio port you connected to as the **HDMI Audio Output** setting in the Signal I/O menu.

Parent topic: [Connecting to Video Sources](#)

Related references

[Input Signal Settings - Signal I/O Menu](#)

Connecting to a Composite Video Source

If your video source has a composite video port, you can connect it to the projector using an optional RCA-style video or A/V cable.

1. Connect the cable with the yellow connector to your video source's yellow video output port.
2. Connect the other end to the projector's **Video** port.

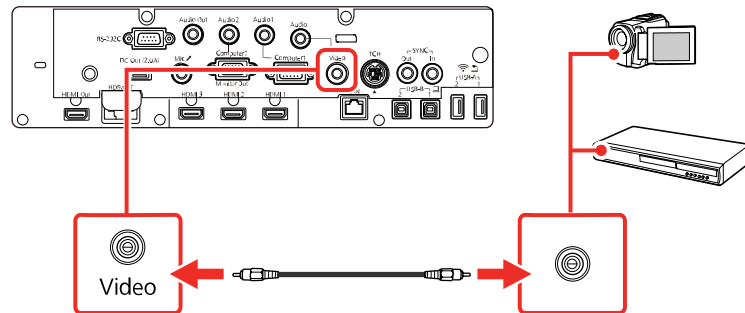

Parent topic: [Connecting to Video Sources](#)

Connecting to a Video Source for Sound

You can play sound through the projector's speaker system if your video source has audio output ports.

If you are projecting video using the **Video** or a **Computer** port, connect the projector to the video source using an optional stereo mini-jack audio cable.

Note: If you connected your video source to the projector using an HDMI cable, the audio signal is transferred with the video signal; you do not need an additional cable for sound.

1. Connect the audio cable to your video source's audio-out ports.
2. Connect the other end of the cable to the projector's **Audio** port that corresponds to the **Computer** or **Video** port you are using for video.

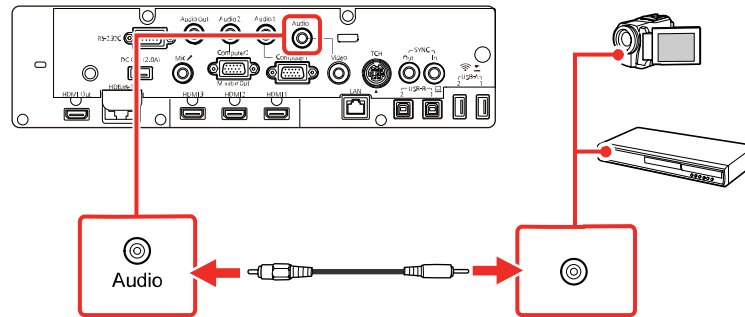

Parent topic: [Connecting to Video Sources](#)

Connecting External Output Devices

See these sections to connect the projector to external output devices.

[Connecting to an External Computer Monitor](#)

[Connecting to an External HDMI Monitor](#)

[Connecting to External Speakers](#)

Parent topic: [Projector Connections](#)

Connecting to an External Computer Monitor

If you connected a computer to the projector's **Computer1** port, you can also connect an external monitor to the projector. This lets you see your presentation on the external monitor even when the projected image is not visible.

To output images to an external VGA monitor, set the **Monitor Out Port** setting to **Monitor Out** in the projector's Signal I/O menu.

If you want to output images to an external monitor when the projector is not projecting any images, you need to select **Always On** as the **AV Output** setting in the projector's Signal I/O menu.

Note: Monitors that use a refresh rate less than 60 Hz may not be able to display images correctly.

1. Make sure your computer is connected to the projector's **Computer** port. If there are two computer ports, make sure you use the **Computer1** port.
2. Connect the external monitor's cable to your projector's **Computer2/Monitor Out** port.

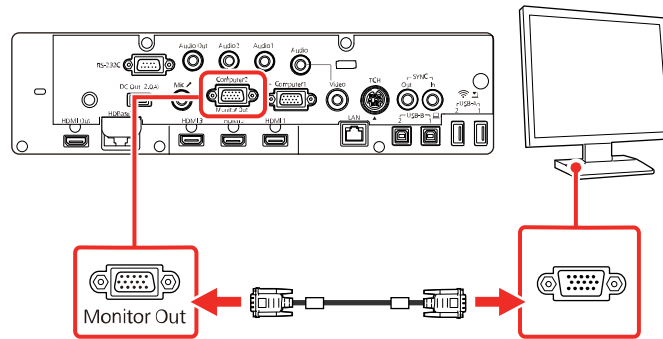

Note: Content you draw using the built-in interactive features is not displayed on an external monitor unless you draw it using Easy Interactive Tools software.

Parent topic: [Connecting External Output Devices](#)

Related references

[Input Signal Settings - Signal I/O Menu](#)

Connecting to an External HDMI Monitor

You can connect an external HDMI monitor to the projector's **HDMI Out** port and use it to display projected content from the currently selected input source (except for the Home screen and images from a Screen Mirroring source).

1. Connect an HDMI cable to your monitor's HDMI input port.
2. Connect the other end to the projector's **HDMI Out** port.

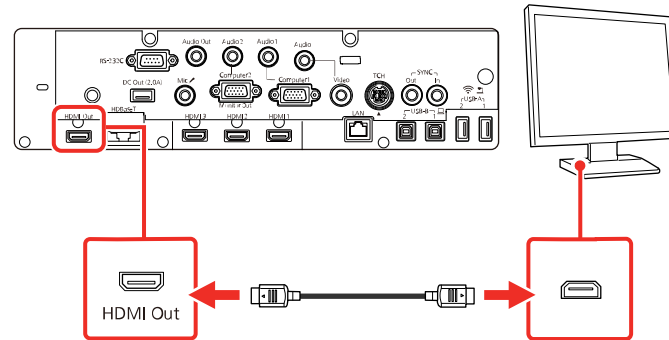

Parent topic: [Connecting External Output Devices](#)

Connecting to External Speakers

To enhance the sound from your presentation, you can connect the projector to external self-powered speakers. You can control the volume using the projector's remote control.

You can also connect the projector to an amplifier with speakers.

Set the **Audio Out Device** setting to **AV System** in the projector's Signal I/O menu. When an audio/video system is not connected to the projector, audio is output from the external speakers even if **Audio Out Device** is set to **AV System**.

If you want to output audio from the external speakers when the projector is not projecting images, you need to select **Always On** as the **A/V Output** setting in the projector's Signal I/O menu.

Note: The projector's built-in speaker system is disabled when you connect external speakers.

1. Make sure your computer or video source is connected to the projector with both audio and video cables as necessary.
2. Locate the appropriate cable to connect your external speakers, such as a stereo mini-jack-to-pin-jack cable, or another type of cable or adapter.

3. Connect one end of the cable to your external speakers as necessary.
4. Connect the stereo mini-jack end of the cable to your projector's **Audio Out** port.

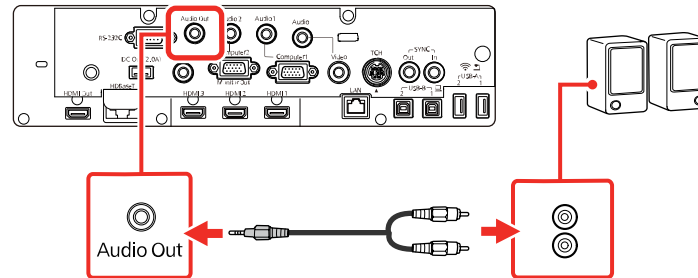

Parent topic: [Connecting External Output Devices](#)

Related references

[Input Signal Settings - Signal I/O Menu](#)

Connecting a Microphone

You can connect a microphone to the projector's **Mic** port to provide audio support during presentations.

Note: The projector does not support plug-in-power microphones. If you want to output audio from the microphone when the projector is not projecting images, select **Always On** as the **A/V Output** setting in the Signal I/O menu.

1. Connect the microphone cable to the projector's **Mic** port.

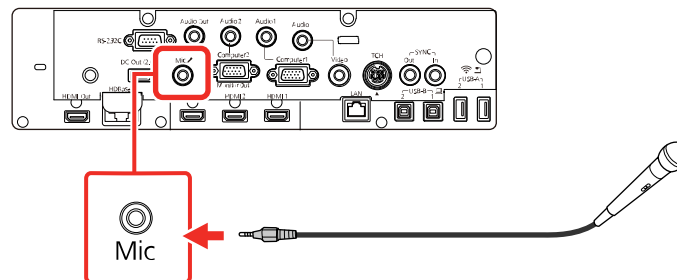

2. Turn on the microphone, if necessary.

3. If you hear a crackling noise or the volume is too high or low, adjust the **Mic Input Level** setting in the Signal I/O menu.

Parent topic: [Projector Connections](#)

Related references

[Input Signal Settings - Signal I/O Menu](#)

Connecting to External USB Devices

Follow the instructions in these sections to connect external USB devices to the projector.

[USB Device Projection](#)

[Connecting a USB Device or Camera to the Projector](#)

[Connecting a USB Device to the Control Pad](#)

[Selecting the Connected USB Source](#)

[Disconnecting a USB Device From the Control Pad or Projector](#)

Parent topic: [Projector Connections](#)

Related tasks

[Starting a PC Free Slideshow](#)

USB Device Projection

You can project images and other content without using a computer or video device by connecting any of these devices to your projector or to the control pad (BrightLink 1485Fi):

- USB flash drive
- Digital camera or smartphone
- USB hard drive

Note: Digital cameras or smartphones must be USB-mounted devices, not TWAIN-compliant devices, and must be USB Mass Storage Class-compliant.

Note: USB hard drives must meet these requirements:

- USB Mass Storage Class-compliant (not all USB Mass Storage Class devices are supported)
- Formatted in FAT16 or FAT32
- Self-powered by their own AC power supplies (bus-powered hard drives are not recommended)
- Does not have multiple partitions

You can project slide shows from image files on a connected USB device.

Parent topic: [Connecting to External USB Devices](#)

Related tasks

[Starting a PC Free Slideshow](#)

Connecting a USB Device or Camera to the Projector

You can connect your USB device or camera to the projector's **USB-A** port and use it to project images and other content.

1. If your USB device came with a power adapter, plug the device into an electrical outlet.
2. Connect the USB cable (or USB flash drive) to one of the projector's **USB-A** ports.

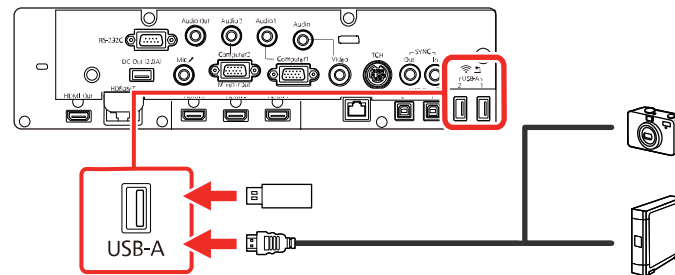

Note: Use the USB cable supplied with or specified for use with your device. Do not connect a USB hub or a USB cable longer than 10 feet (3 m), or the device may not operate correctly.

3. Connect the other end of the cable (if applicable) to your device.

Parent topic: [Connecting to External USB Devices](#)

Related tasks

[Starting a PC Free Slideshow](#)

Connecting a USB Device to the Control Pad

You can connect your USB device to the **USB-A** port on the control pad (BrightLink 1485Fi) and use it to project images and other content.

1. If your USB device came with a power adapter, plug the device into an electrical outlet.
2. Connect a USB cable to either **USB-A** port on the projector and to the upper **USB-B** port on the control pad.
3. Enable **Connect ELPHD02** in the HDBaseT settings of the projector's Signal I/O menu.

4. Connect the USB cable for the device (or a USB flash drive) to the **USB-A** port on the bottom of the control pad.

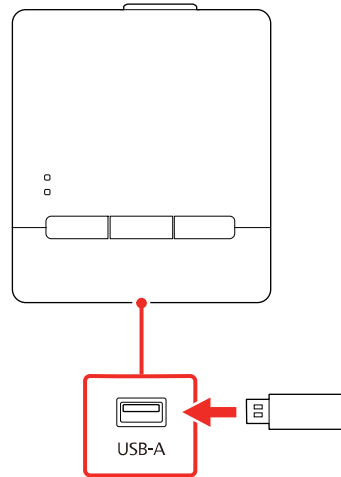

5. Connect the other end of the cable (if applicable) to your device.

Note: You can also connect a USB device directly to one of the projector's **USB-A** ports.

Parent topic: [Connecting to External USB Devices](#)

Related tasks

[Starting a PC Free Slideshow](#)

Selecting the Connected USB Source

You can switch the projector's display to the source you connected to one of the **USB-A** ports. To display the connected USB device, select the **USB1** source.

Note: If you have connected a document camera using a USB cable, select the **USB2** source.

1. Make sure the connected USB source is turned on, if necessary.
2. Press the **USB** or **Source Search** button on the remote control and select the **USB1** or **USB2** source.

Parent topic: [Connecting to External USB Devices](#)

Related tasks

[Starting a PC Free Slideshow](#)

Disconnecting a USB Device From the Control Pad or Projector

When you finish presenting with a connected USB device, you must prepare to disconnect the device from the control pad (BrightLink 1485Fi) or projector.

1. If the device has a power button, turn off and unplug the device.
2. Disconnect the USB device (or cable) from the control pad (BrightLink 1485Fi) or projector.

Parent topic: [Connecting to External USB Devices](#)

Related tasks

[Starting a PC Free Slideshow](#)

Connecting to a Document Camera

You can connect a document camera to your projector to project images viewed by the camera. Depending on the document camera model, you can also control it using the interactive features.

Note: If you connect a document camera to one of the **USB-A** ports on the projector, select the **USB2** source to display the image. You cannot simultaneously connect two document cameras to the **USB-A** ports.

Depending on your Epson document camera model, do one of the following to connect the document camera to your projector:

- For the Epson DC-07 document camera, locate the USB cable that came with the camera and connect it to the projector's port and to the document camera's USB Type B port.
- For the Epson DC-11 document camera, connect it to the projector's **Computer** or **Video** port and to the corresponding port on the document camera. See the document camera manual for details.
- For the Epson DC-12 document camera, connect it to the projector's **HDMI**, **Computer**, or **Video** port and to the corresponding port on the document camera. See the document camera manual for details.
- For the Epson DC-13 document camera, connect it to the projector's **HDMI**, **Computer**, or **Video** port and to the corresponding port on the document camera. See the document camera manual for details.
- For the Epson DC-20 document camera, connect it to the projector's **HDMI**, **Computer**, or **Video** port and to the corresponding port on the document camera. See the document camera manual for details.
- For the Epson DC-21 document camera, connect it to the projector's **HDMI**, **Computer**, or **Video** port and to the corresponding port on the document camera. See the document camera manual for details.

Note: For additional features supported by software, connect your document camera to your computer instead of the projector. See the document camera manual for details.

Parent topic: [Projector Connections](#)

Connecting a Printer to the Control Pad

You can connect an Epson printer or all-in-one device to the **USB-A** port on the control pad (BrightLink 1485Fi) and use it to print your projected and annotated content. Make sure the printer meets the control command requirements.

Note: You can connect a wireless printer by selecting **Network Printer** as the **Print > Printer** setting in the Interactive menu.

1. Connect a USB cable to one of the **USB-A** ports on the projector and to the **USB-B** port at the top of the control pad.
2. Connect another USB cable to the **USB-A** port on the bottom of the control pad. Make sure the cable is no longer than 16.4 ft (5 m).
3. Connect the other end of the cable to the USB Type B port on the printer.

Parent topic: [Projector Connections](#)

Related references

[Interactive Settings - Interactive Menu](#)

Connecting Multiple Projectors of the Same Model

You can connect up to four projectors of the same model in the same room to project a single unified image (BrightLink 1485Fi).

Note: The interactive features are available only when connecting two projectors (DuoLink). The two projectors must be synchronized using the optional remote control cable set (V12H005C28) and a USB-A to USB-B cable.

1. Connect the computer and the projectors using HDMI cables as shown.

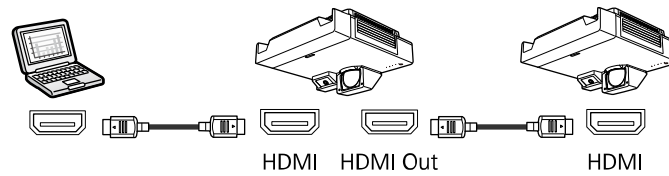

Note: If you are connecting three or more projectors, connect the projectors in a chain as shown.

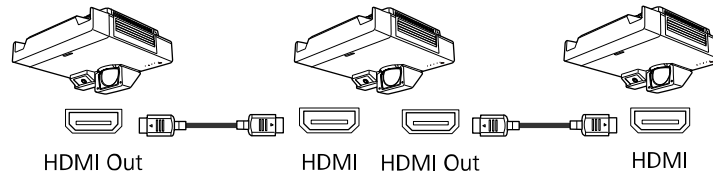

2. If you are using interactive features, connect one end of the stereo mini cable to the **SYNC Out** port starting from the projector on the left, and connect the other end to the **SYNC In** port on the other projector.

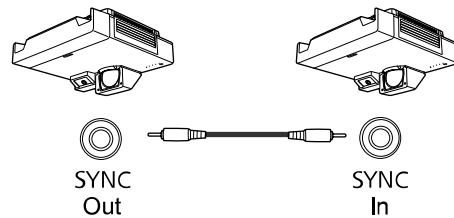

3. If you are using interactive features, connect the computer and the projectors using USB cables as shown.

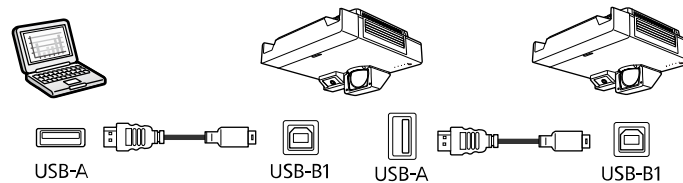

Note: When you set the **USB-B2** setting to **Off** in the projector's Pen/Touch menu, connect the USB cable to the other projector's **USB-B1** port. When you set the **USB-B2** setting to anything other than **Off**, connect the USB cable to the other projector's **USB-B2** port.

4. After making the appropriate connections, you need to adjust the necessary projector menu settings. Click the link below.

Note: You may need to restart the projector. Follow the on-screen instructions.

[Multiple Projector Connection Menu Settings](#)

Parent topic: [Projector Connections](#)

Related concepts

[Using Multiple Projectors \(DuoLink\)](#)

Related references

[Multiple Projector Connection Menu Settings](#)

Related tasks

[Connecting Multiple Projectors of the Same Model](#)

Multiple Projector Connection Menu Settings

After connecting multiple projectors to project a unified image, see the tables below to select the correct projector menu settings. Make sure your computer is connected to Projector 1 (the left-most projector in your setup).

Interactive Setup (2 Projectors)

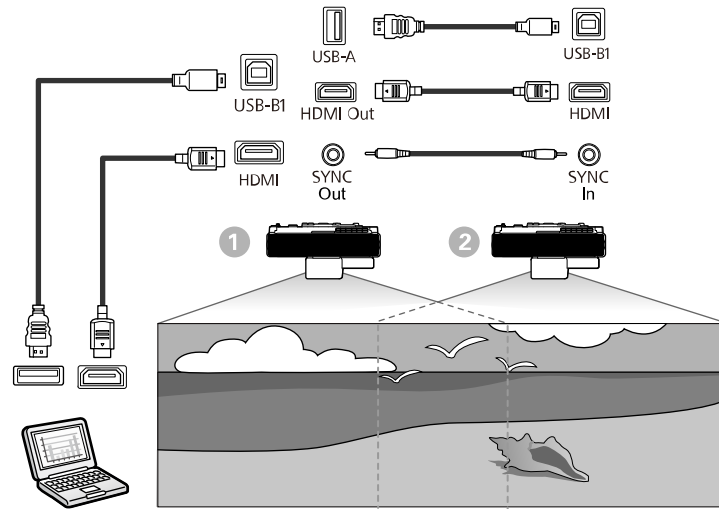

Setting	Projector 1	Projector 2
Image Menu		
Color Mode	Multi-Projection	Multi-Projection
Signal I/O Menu		
EDID	3240 x 1080/60Hz	3240 x 1080/60Hz
Pen/Touch Menu		
Installation of Projectors > Sync of Projectors	Wired	Wired
Multi-Projection Menu		
HDMI Out Setting	Process Out	Process Out
Order	Specify the position of the projectors in number order from left to right	
Connect Computer	Yes	No

Setting	Projector 1	Projector 2
Edge Blending > select any edge > Blend Start Position	0	0
Edge Blending > select any edge > Blend Range	600	600

Note: If you are using the projectors in the same room as another projector that does not support multi-projector connections, set the **Installation of Projectors** > **Infrared Intensity** setting to **Strong**.

Non-interactive Setup (2-4 Projectors)

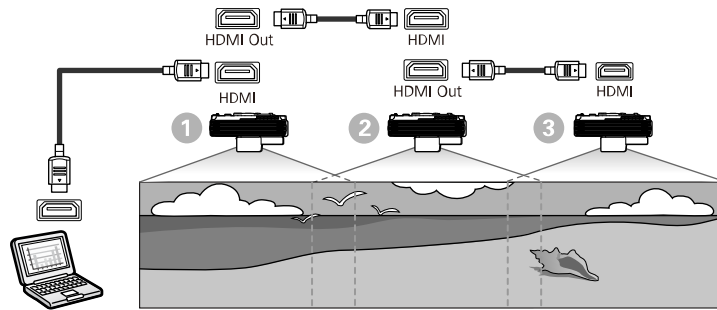

Setting	Projector 1	Projectors 2-4
Image Menu		
Color Mode	Multi-Projection	Multi-Projection
Multi-Projection Menu		
HDMI Out Setting	Pass Through	Pass Through
Number of Projectors	Specify the number of projectors connected in a series	
Order	Specify the position of the projectors in number order from left to right	

Parent topic: [Connecting Multiple Projectors of the Same Model](#)

Installing Batteries in the Remote Control

The remote control uses the two AA batteries that came with the projector. Replace the batteries as soon as they run out.

Caution: Use only the type of batteries specified in this manual. Do not install batteries of different types, or mix new and old batteries.

1. Remove the battery cover.

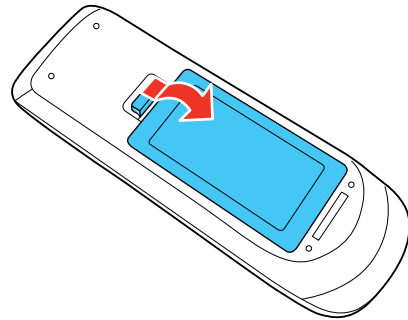

2. Insert the batteries with the + and – ends facing as shown.

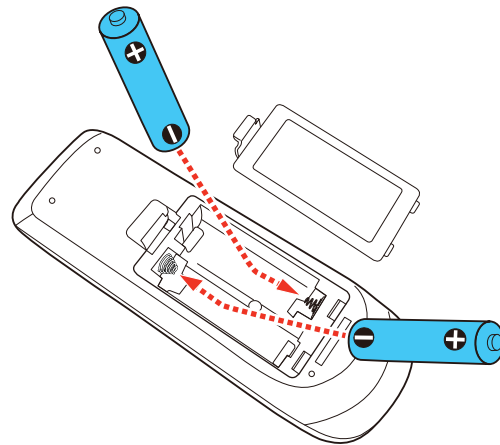

Warning: Make sure the batteries are inserted in the correct positions. If the batteries are not inserted correctly, they could explode or leak, causing a fire, injury, or damage to the product.

3. Replace the battery cover and press it down until it clicks into place.

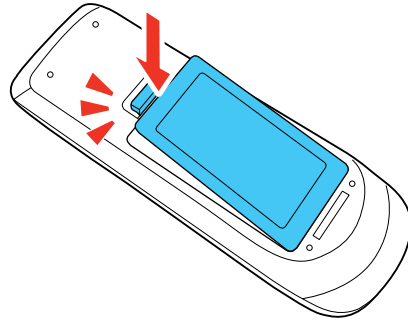

Warning: Dispose of used batteries according to local regulations. Do not expose batteries to heat or flame. Keep batteries out of the reach of children; they are choking hazards and are very dangerous if swallowed.

Parent topic: [Setting Up the Projector](#)

Installing Batteries in the Pens

Each pen uses one AA battery. Replace the battery as soon as it runs out.

1. Remove the battery cover as shown.

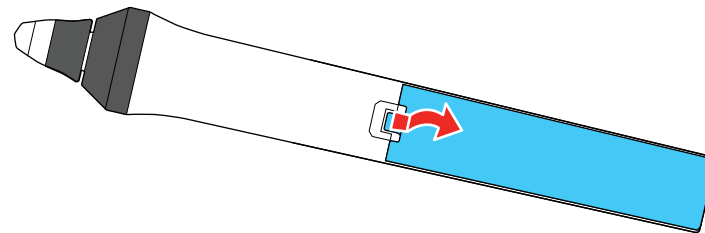

2. Insert the battery with the + and – ends facing as shown.

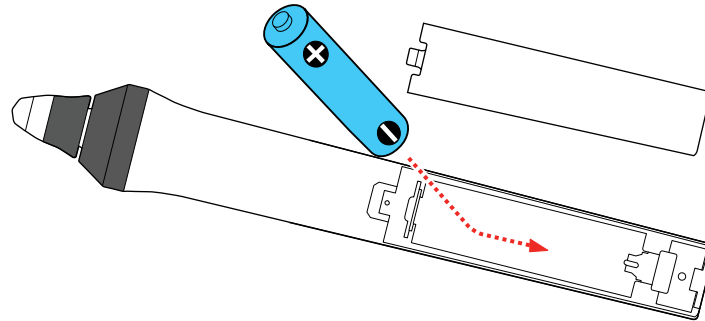

Warning: Make sure the batteries are inserted in the correct positions. If the batteries are not inserted correctly, they could explode or leak, causing a fire, injury, or damage to the product.

3. Replace the battery cover and press it down until it clicks into place.

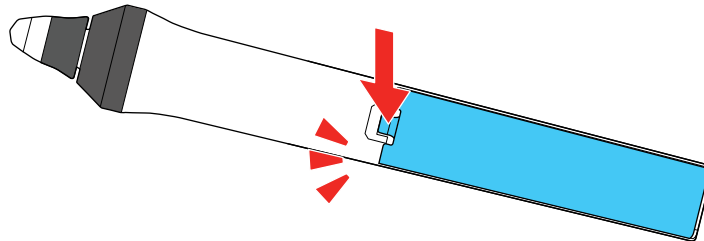

Warning: Dispose of used batteries according to local regulations. Do not expose batteries to heat or flame. Keep batteries out of the reach of children; they are choking hazards and are very dangerous if swallowed.

Parent topic: [Setting Up the Projector](#)

Using the Projector on a Network

Follow the instructions in these sections to set up your projector for use on a network.

Note: The interactive features may be slower over a network connection than over a USB connection.

[Wired Network Projection](#)

[Wireless Network Projection](#)

[Wireless Network Projection from a Mobile Device or Windows Computer \(Screen Mirroring\)](#)

[Setting Up Projector Network E-Mail Alerts](#)

[Setting Up Monitoring Using SNMP](#)

[Controlling a Networked Projector Using a Web Browser](#)

[Creating an Address Book](#)

[Using Crestron Connected](#)

[Registering a Digital Certificate on the Projector](#)

Wired Network Projection

You can project through a wired network. To do this, you connect the projector to your network with an Ethernet cable, and then set up your projector and computer for network projection.

After connecting and setting up the projector, install the projector software. You may need to install it from a software CD, if included, or download the software and manuals as necessary.

Note: If your projector is connected via a LAN (Ethernet) cable to a network that includes a wireless access point, you can connect to the projector wirelessly through the access point using the Epson network software.

[Connecting to a Wired Network](#)

[Selecting Wired Network Settings](#)

Parent topic: [Using the Projector on a Network](#)

Related references

[Additional Projector Software and Manuals](#)

Connecting to a Wired Network

To connect the projector to a wired local area network (LAN), use a 100Base-TX or 10Base-T network cable. To ensure proper data transmission, use a Category 5 shielded cable or higher.

1. Connect one end of the network cable to your network hub, switch, or router.
2. Connect the other end of the cable to the projector's **LAN** port.

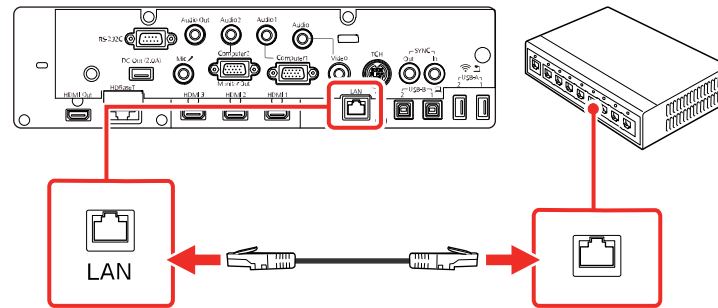

Parent topic: [Wired Network Projection](#)

Selecting Wired Network Settings

Before you can project from computers on your network, you must select the network settings for the projector using its menu system.

Note: Make sure you already connected the projector to your wired network using the **LAN** port.

1. Turn on the projector.
2. Press the **Menu** button.

3. Select the **Network** menu and press **↵ Enter**.

Frequently Used Items	Network
Image	Wireless LAN Info.
Signal I/O	Wireless LAN Info. IPv6
Installation	Simple AP
Display	Wired LAN Info.
Operation	Wired LAN Info. IPv6
Management	Network Settings
Network	Reset Network Settings
Pen/Touch	Pen/Touch
Interactive	Auto Calibration
Multi-Projection	Manual Calibration
Memory	Touch Unit
ECO	Installation of Projectors
Initial/All Settings	Pen Hovering On
	PC Interactivity
	Reset Pen/Touch Settings
	Interactive
	Drawing Function On

4. Select **Network Settings** and press **↵ Enter**.
5. Select **Projector Name** and enter a name up to 16 alphanumeric characters long to identify the projector on a network.
6. Set the **Priority Control Interface** setting to **Wired LAN**.
7. Select the **Wired LAN** menu and press **↵ Enter**.

[Wired LAN]	Return
IP Settings	
DNS Server 1	0.0.0.0
DNS Server 2	0.0.0.0
IPv6	Off ▼
IP Address Display	On

8. Select **IP Settings** and press **↵ Enter**.
9. Select your IP settings as necessary:
 - If your network assigns addresses automatically, turn on the **DHCP** setting.
 - If you must set addresses manually, turn off **DHCP** and enter the projector's **IP Address**, **Subnet Mask**, and **Gateway Address** as needed.

Note: To highlight the numbers you want from the displayed keyboard, press the arrow buttons on the remote control. To select a highlighted number, press **↵ Enter**. Alternatively, press and hold the **Num** button on the remote control while entering the desired numbers.

10. To prevent display of the IP address on the standby screen, turn off **IP Address Display** in the Wired LAN menu.
11. Select **Return** and press **↵ Enter** to return to the Network Settings menu.
12. Select **Network Projection** and press **↵ Enter**.

You see a screen like this:

[Network Projection]		Return
Projector Keyword	Off	
Epson iProjection	On	^
SSID Display	On	
Display LAN Info.	Text & QR Code	
Moderator Password		
Keyword Interrupt Display	Off	
Screen Mirroring	On	^
Interrupt Connection	On	
Adjust Image Quality	1 (Fine)	
Capture	Disabled	
Screen Mirroring Info.	On	
Message Broadcasting	Off	
Screen Sharing	On	

13. Turn on the **Projector Keyword** setting if you want to prevent access to the projector by anyone not in the room with it.
 14. Set the **Epson iProjection** setting to **On**.
 15. Select the following options as necessary:
 - **Display LAN Info** lets you select how the projector displays network information. You can select an option to display a QR code that lets you quickly connect your iOS or Android devices using the Epson iProjection app.
 - **Moderator Password** lets you enter a password up to 4 numbers long for accessing the projector as a moderator with the Epson iProjection (Windows/Mac) software or the Epson iProjection app. (No default password.)
 - **Keyword Interrupt Display** lets you select whether to display a projector keyword on the projected image when accessing the projector using Epson iProjection.
- Note:** Use the displayed keyboard to enter the password and keyword. Press the arrow buttons on the remote control to highlight characters and press **↵ Enter** to select them.
16. When you finish selecting settings, select **Return** and press **↵ Enter** to return the **Network Settings** menu.
 17. Select **Set**, and follow the on-screen instructions to save your settings and exit the menus.

Parent topic: [Wired Network Projection](#)

Wireless Network Projection

You can project over a wireless network. To do this, you must set up your projector and computer for wireless projection.

To connect wirelessly to your projector, configure the connection using the projector's Network menus.

After connecting and setting up the projector, install the projector software. You may need to install it from a software CD, if included, or download the software and manuals as necessary.

Note: If your projector is connected via a LAN cable to a network that includes a wireless access point, you can connect to the projector wirelessly through the access point using the Epson network software.

[Installing the Wireless LAN Module](#)

[Connecting Directly to a Smartphone or Tablet](#)

[Using Quick Wireless Connection \(Windows\)](#)

[Selecting Wireless Network Settings Manually](#)
[Selecting Wireless Network Settings in Windows](#)
[Selecting Wireless Network Settings on Mac](#)
[Setting Up Wireless Network Security](#)

Parent topic: [Using the Projector on a Network](#)

Related references

[Additional Projector Software and Manuals](#)

Installing the Wireless LAN Module

To use the additional wireless connections, install the optional Epson 802.11b/g/n wireless module in the projector. Do not install any other type of wireless module.

Caution: Never remove the module while its indicator light is blue or flashing, or while you are projecting wirelessly. You may damage the module or lose data.

Note: The wireless LAN module is not included with your projector.

1. Turn off the projector and unplug the power cord.

2. Loosen the screws securing the cable cover and lift off the cable cover, if it is attached.

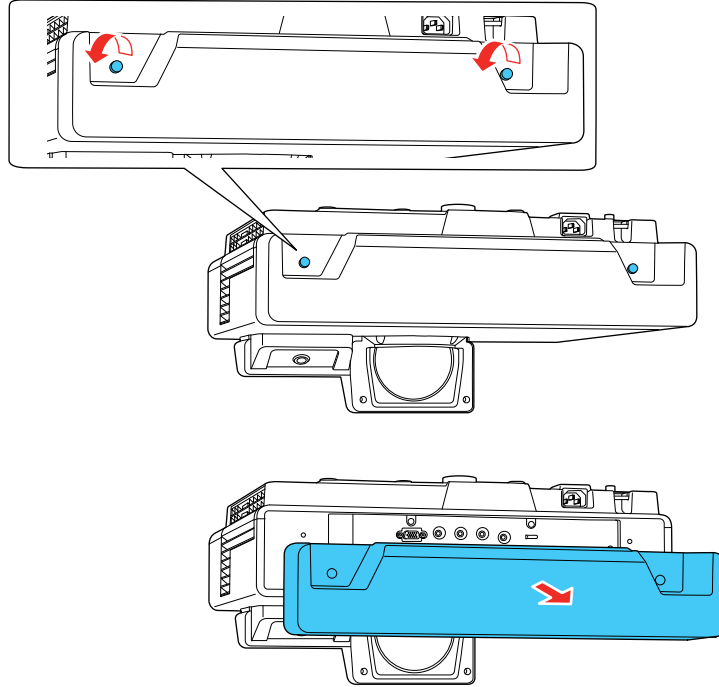

3. Insert the wireless LAN module into a **USB-A** port on the projector.

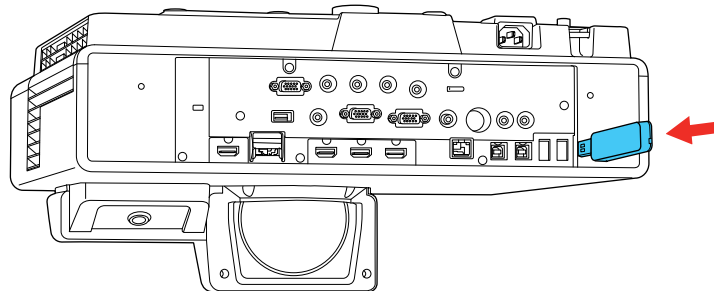

4. Replace the cable cover and tighten the cable cover screws.

5. Plug in and turn on the projector.

Parent topic: [Wireless Network Projection](#)

Related references

[Optional Equipment and Replacement Parts](#)

Connecting Directly to a Smartphone or Tablet

You can display a QR code on the screen and use it to connect a single smartphone or tablet to your projector with the Epson iProjection app.

1. Download the latest version of the Epson iProjection app from the App Store or Google Play and install it on your smartphone or tablet.
2. Press the **Menu** button on the projector or the remote control.
3. Select the **Management** menu and press **↵ Enter**.

Frequently Used Items	Management	
Image	User Button	Light Source Mode
Signal I/O	User's Logo	
Installation	User Pattern	
Display	Control Panel Lock	Off
Operation	Color Uniformity	
Management	Refresh Mode	
Network	Light Source Calibration	
Pen/Touch	Date & Time	
Interactive	Schedule Settings	
Multi-Projection	Wireless LAN Power	
Memory	Wireless LAN Diagnosis	1
ECO	Log Save Destination	USB and Internal Memory
Initial/All Settings	Batch Setup Range	
	Language	English
	Information	
	Display Logs	
	Reset Management Settings	
	Network	

4. Select **On** as the **Wireless LAN Power** setting.

5. Select the **Network** menu and press **↵ Enter**.

Frequently Used Items	Network
Image	Wireless LAN Info.
Signal I/O	Wireless LAN Info. IPv6
Installation	Simple AP
Display	Wired LAN Info.
Operation	Wired LAN Info. IPv6
Management	Network Settings
Network	Reset Network Settings
Pen/Touch	Pen/Touch
Interactive	Auto Calibration
Multi-Projection	Manual Calibration
Memory	Touch Unit
ECO	Installation of Projectors
Initial/All Settings	Pen Hovering On
	PC Interactivity
	Reset Pen/Touch Settings
	Interactive
	Drawing Function On

6. Select **Network Settings** and press **↵ Enter**.

7. Make sure **Simple AP** is set to **On**.

8. Select **Network Projection** and press **↵ Enter**.

[Network Projection]		Return
Projector Keyword	Off	
Epson iProjection	On	^
SSID Display	On	
Display LAN Info.	Text & QR Code	
Moderator Password		
Keyword Interrupt Display	Off	
Screen Mirroring	On	^
Interrupt Connection	On	
Adjust Image Quality	1 (Fine)	
Capture	Disabled	
Screen Mirroring Info.	On	
Message Broadcasting	Off	
Screen Sharing	On	

9. Turn on the **Projector Keyword** setting if you want to prevent access to the projector by anyone not in the room with it.
10. Select **On** as the **Epson iProjection** setting.
11. Select **Return** and press **↵ Enter** to return to the **Network Settings** menu.
12. Select the following settings as necessary:
- **SSID Display** selects whether to display the SSID on the network standby screen and Home screen.
 - **Display LAN Info** lets you select how the projector displays network information. You can select an option to display a QR code that lets you quickly connect your iOS or Android devices using the Epson iProjection app.
 - **Moderator Password** lets you enter a password up to 4 numbers long for accessing the projector as a moderator with the Epson iProjection (Windows/Mac) software or the Epson iProjection app. (No default password.)

- **Keyword Interrupt Display** lets you select whether to display a projector keyword on the projected image when accessing the projector using Epson iProjection.
13. When you finish selecting settings, select **Return** and press **↵ Enter** to return to the **Network Settings** menu
 14. Select **Set**, and follow the on-screen instructions to save your settings and exit the menus.
 15. Press the **LAN** button on the remote control.

Your projector displays a QR code on the projection surface. You can press the **↵ Enter** button to hide and show the QR code on the screen. If you do not see the QR code, set the **Display LAN Info** setting to **Text & QR Code** in the Network menu.
 16. Open the Epson iProjection app on your smartphone or tablet.
 17. Use the QR code reader feature to read the QR code and connect your device to the projector.

Note: The projector and the smartphone must be on the same wireless network in order to establish a connection.

Your smartphone or tablet is now connected to your projector. Visit epson.com/iprojection (U.S.) or epson.ca/iprojection (Canada) for information on controlling your projector with the Epson iProjection app.

Parent topic: [Wireless Network Projection](#)

Using Quick Wireless Connection (Windows)

You can create a Quick Wireless Connection USB Key to quickly connect the projector to a Windows computer wirelessly. Then you can project your presentation and remove the key when you are done.

Note: A USB flash drive is not included with your projector.

1. Create a Quick Wireless Connection USB Key with a USB flash drive and the Epson iProjection (Windows) software.

Note: See the online *Epson iProjection Operation Guide* for instructions.

2. Make sure the wireless LAN module is installed in your projector.
3. Turn on the projector.
4. Press the **LAN** button on the remote control.

The LAN standby screen is displayed.

5. Verify the SSID and IP address.
6. Insert the USB key into the projector's **USB-A1** port.

Note: If the control pad is connected to the projector, you can connect the USB key to the **USB-A** port on the control pad instead.

You see a projected message that the network information update is complete.

7. Remove the USB key.
8. Insert the USB key into a USB port on your computer.
9. Follow the on-screen instructions to install the Epson iProjection software.

Note: If you see a Windows Firewall message, click **Yes** to disable the firewall. You need administrator authority to install the software. If it is not installed automatically, double-click **MPPLaunch.exe** in the USB key.

After a few minutes, your computer image is displayed by the projector. If it does not appear, press the **LAN** or **Source Search** button on your remote control or restart your computer.

10. Run your presentation as necessary.
11. When you finish projecting wirelessly, select the **Safely Remove Hardware** option in the Windows taskbar, then remove the USB key from your computer.

Note: You can share the USB key with other computers without disconnecting your computer. You may need to restart your computer to reactivate your wireless LAN connection.

Parent topic: [Wireless Network Projection](#)

Related references

[Additional Projector Software and Manuals](#)

Selecting Wireless Network Settings Manually

Before you can project from your wireless network, you must select the network settings for the projector using its menu system.

1. Turn on the projector.
2. Press the **Menu** button.

3. Select the **Management** menu and press **↵ Enter**.

Frequently Used Items	Management
Image	User Button Light Source Mode
Signal I/O	User's Logo
Installation	User Pattern
Display	Control Panel Lock Off
Operation	Color Uniformity
Management	Refresh Mode
Network	Light Source Calibration
Pen/Touch	Date & Time
Interactive	Schedule Settings
Multi-Projection	Wireless LAN Power
Memory	Wireless LAN Diagnosis 1
ECO	Log Save Destination USB and Internal Memory
Initial/All Settings	Batch Setup Range
	Language English
	Information
	Display Logs
	Reset Management Settings
	Network

4. Select **On** as the **Wireless LAN Power** setting.

5. Select the **Network** menu and press **↵ Enter**.

Frequently Used Items	Network
Image	Wireless LAN Info.
Signal I/O	Wireless LAN Info. IPv6
Installation	Simple AP
Display	Wired LAN Info.
Operation	Wired LAN Info. IPv6
Management	Network Settings
Network	Reset Network Settings
Pen/Touch	Pen/Touch
Interactive	Auto Calibration
Multi-Projection	Manual Calibration
Memory	Touch Unit
ECO	Installation of Projectors
Initial/All Settings	Pen Hovering On
	PC Interactivity
	Reset Pen/Touch Settings
	Interactive
	Drawing Function On

6. Select **Network Settings** and press **↵ Enter**.
7. Select **Projector Name** and enter a name up to 16 alphanumeric characters long to identify the projector on the network.
8. Set the **Priority Control Interface** setting to **Wireless LAN**.
9. Select the connection method:
 - To connect directly to a wireless device (Simple AP mode), set the **Simple AP** setting to **On** and go to step 16.
 - To connect to a device via a wireless network router (infrastructure mode), set the **Simple AP** setting to **Off** and go to the next step.
 - If you installed the optional wireless LAN module and want to use both connection methods, set the **Simple AP** setting to **On** and go to the next step.

10. Select the **Wireless LAN** menu and press **↵ Enter**.

[Wireless LAN]	Return
Search Access Point	
SSID	
Security	Open
IP Settings	
DNS Server 1	0.0.0.0
DNS Server 2	0.0.0.0
IPv6	Off ▼
IP Address Display	On

11. Select **Search Access Point** and press **↵ Enter**.

The projector searches for wireless networks.

12. Select the network you want to connect to and enter the password, if necessary.

Note: If you need to assign the SSID manually, select **SSID** to enter the SSID.

13. Select **IP Settings** and press **↵ Enter**.

14. Select your IP settings as necessary:

- If your network assigns addresses automatically, turn on the **DHCP** setting.
- If you must set addresses manually, turn off **DHCP** and enter the projector's **IP Address**, **Subnet Mask**, and **Gateway Address** as needed.

Note: Do not use these addresses: 0.0.0.0, 127.x.x.x, 192.0.2.x or 224.0.0.0 through 255.255.255.255 (where x is a number from 0 to 255) for **IP Address**, 255.255.255.255 or 0.0.0.0 through 254.255.255.255 for **Subnet Mask**, and 0.0.0.0, 127.x.x.x or 224.0.0.0 through 255.255.255.255 for **Gateway Address**. For DNS Server addresses, do not use the following IP

addresses: 127.x.x.x (where x is a number from 0 to 255). When these settings are not set, DNS server information is acquired using DHCP.

Note: To highlight the numbers you want from the displayed keyboard, press the arrow buttons on the remote control. To select a highlighted number, press **↵ Enter**.

15. To prevent display of the IP address on the network information screen, turn off **IP Address Display**.
16. Select **Return** and press **↵ Enter** to return to the Network Settings menu.
17. Select the **Network Projection** menu and press **↵ Enter**.

[Network Projection]		Return
Projector Keyword	Off	
Epson iProjection	On	^
SSID Display	On	
Display LAN Info.	Text & QR Code	
Moderator Password		
Keyword Interrupt Display	Off	
Screen Mirroring	On	^
Interrupt Connection	On	
Adjust Image Quality	1 (Fine)	
Capture	Disabled	
Screen Mirroring Info.	On	
Message Broadcasting	Off	
Screen Sharing	On	

18. Turn on the **Projector Keyword** setting if you want to prevent access to the projector by anyone not in the room with it.
19. Set the **Epson iProjection** setting to **On**.

20. Select the following options as necessary:

- **SSID Display** lets you select whether to display the projector's SSID on the standby screen and Home screen.
- **Display LAN Info** lets you select how the projector displays network information. You can select an option to display a QR code that lets you quickly connect your iOS or Android devices with the Epson iProjection app.
- **Moderator Password** lets you enter a password up to 4 numbers long for accessing the projector as a moderator with the Epson iProjection (Windows/Mac) software or the Epson iProjection app.
- **Keyword Interrupt Display** lets you select whether to display a projector keyword on the projected image when accessing the projector using Epson iProjection.

Note: Use the displayed keyboard to enter the password and keyword. Press the arrow buttons on the remote control to highlight characters and press **↵ Enter** to select them.

21. When you finish selecting settings, select **Return** to return to the **Network Settings** menu.

22. Select **Set** and follow the on-screen instructions to save your settings and exit the menus.

After you complete the wireless settings for your projector, you need to select the wireless network on your computer, or iOS or Android device.

Note: You can press the **LAN** button on the remote control to check your network security settings after completing the wireless settings.

[Wireless LAN Menu Settings](#)

Parent topic: [Wireless Network Projection](#)

Related references

[Optional Equipment and Replacement Parts](#)

Wireless LAN Menu Settings

Setting	Options	Description
Search Access Point	To Search View	Search for available wireless network access points in Advanced connection mode

Setting	Options	Description
SSID	Up 32 alphanumeric characters	Manually set the SSID (network name) of the wireless LAN system the projector is connecting to
Security	WPA2/WPA3-PSK WPA2/WPA3-EAP WPA3-PSK WPA3-EAP Open	Selects the type of security used on the wireless network WPA2/WPA3-PSK: uses WPA2/WPA3 personal mode; encryption is dependent on the access point settings; Passphrase must be the same as the access point WPA2/WPA3-EAP: uses WPA2/WPA3 enterprise mode; encryption is dependent on the access point settings WPA3-PSK: uses WPA3 security with AES for encryption. Use the Passphrase value to establish a connection from a computer WPA3-EAP: uses WPA3 enterprise mode; encryption is dependent on the access point settings
Passphrase	Various passphrases from 8 to 32 characters (from a web browser, the maximum is 63 characters)	Selects the pre-shared key used on the network; passphrases are case-sensitive. If the network settings are reset after the passphrase has been changed more than once, the first passphrase is restored. This setting is only displayed when Security is set to WPA3-PSK or WPA2/WPA3-PSK .

Setting	Options	Description
EAP Method	EAP Type User name Password Client Certificate Verify Server Certificate CA certificate RADIUS Server Name	Sets the EAP settings for WPA3-EAP and WPA2/WPA3-EAP security
IP Settings	DHCP (On or Off) IP Address Subnet Mask Gateway Address	Selects DHCP if your network assigns IP addresses automatically, or turns off DHCP so you can enter the network's IP address, subnet mask, and gateway address as needed
DNS Server 1/ DNS Server 2	Various IP addresses	Sets the IP address for the DNS server using 0 to 255 for each address field. The DNS server resolves the host name
IPv6	On Off	Enables IPv6 to allow monitoring and control of the projector over a network using Epson Web Control and PjLink
Auto Configuration	On Off	Selects whether to automatically assign addresses according to the Router Advertisement
Use Temporary Address	On Off	Enables use of a temporary IPv6 address
IP Address Display	On Off	Selects whether to display the IP address on the network standby screen and Home screen

Parent topic: [Selecting Wireless Network Settings Manually](#)

Selecting Wireless Network Settings in Windows

Before connecting to the projector, select the correct wireless network on your computer.

1. To access your wireless utility software, access the Desktop and double-click the network icon on the Windows taskbar.
2. Do one of the following:
 - If your projector is set up on an existing network (Advanced mode), select the network name (SSID).
 - If your projector is configured for Quick mode, select the projector's SSID.
3. Click **Connect**.

Parent topic: [Wireless Network Projection](#)

Selecting Wireless Network Settings on Mac

Before connecting to the projector, select the correct wireless network on your Mac.

1. Click the AirPort icon on the menu bar at the top of the screen.
2. Make sure AirPort is turned on, then do one of the following:
 - If your projector is set up on an existing network (Advanced mode), select the network name (SSID).
 - If your projector is configured for Quick mode, select the projector's SSID.

Parent topic: [Wireless Network Projection](#)

Setting Up Wireless Network Security

You can set up security for your projector to use on a wireless network. Set up one of the following security options to match the settings used on your network:

- WPA2-PSK (Simple AP mode only)
- WPA3-PSK
- WPA2/WPA3-PSK
- WPA3-EAP
- WPA2/WPA3-EAP

Note: To set up WPA3-EAP or WPA2/WPA3-EAP security, register your digital certificate file and place it on a USB storage device for connection to your projector.

1. Press the **Menu** button.
2. Select the **Network** menu and press **↵ Enter**.

Frequently Used Items	Network
Image	Wireless LAN Info.
Signal I/O	Wireless LAN Info. IPv6
Installation	Simple AP
Display	Wired LAN Info.
Operation	Wired LAN Info. IPv6
Management	Network Settings
	Reset Network Settings
Network	Pen/Touch
Pen/Touch	Auto Calibration
Interactive	Manual Calibration
Multi-Projection	Touch Unit
Memory	Installation of Projectors
ECO	Pen Hovering On
Initial/All Settings	PC Interactivity
	Reset Pen/Touch Settings
	Interactive
	Drawing Function On

3. Select **Network Settings** and press **↵ Enter**.
4. Do one of the following:
 - To connect directly to a wireless device (Simple AP mode), select **Passphrase**, press **↵ Enter**, and enter a passphrase from 8 to 63 characters long. When you are done, return to the **Network Settings** screen, select **Set**, and follow the on-screen instructions to save your settings and exit the menus. Skip the rest of these steps.
 - To connect to a device via a wireless network router (infrastructure mode), select the **Wireless LAN** menu and press **↵ Enter**. Continue with the next step.
5. Select the **Security** setting and press **↵ Enter**.
6. Select the security settings for your network.
7. Do one of the following according to the security you selected:
 - **WPA3-PSK** or **WPA2/WPA3-PSK**: Select **Passphrase**, press **Enter**, and enter a passphrase from 8 to 63 characters long. Then continue with step 9.

- **WPA3-EAP** or **WPA2/WPA3-EAP**: Select **EAP Type** and press **Enter**.
8. Select the protocol for authentication as the **EAP Type** setting.
 9. When you are finished, select **Return** and press **↩ Enter** to return to the **Network Settings** menu.
 10. Select **Set**, and follow the on-screen instructions to save your settings and exit the menus.

Parent topic: [Wireless Network Projection](#)

Related topics

[Registering a Digital Certificate on the Projector](#)

Wireless Network Projection from a Mobile Device or Windows Computer (Screen Mirroring)

You can send images to your projector from mobile devices such as laptops, smartphones, and tablets using Miracast technology or from a Windows computer. If your device supports Miracast, you do not need to install any additional software. When using a Windows computer, make sure the necessary adapter for the Miracast connection is available.

You can connect two devices simultaneously using Miracast. The projector detects the input sources as Screen Mirroring1 and Screen Mirroring2. Set **Interrupt Connection** to **Off**.

[Screen Mirroring Restrictions](#)

[Selecting Screen Mirroring Settings](#)

[Connecting for Screen Mirroring with a Windows 8.x/Windows 10 Computer](#)

[Connecting for Screen Mirroring with Miracast](#)

Parent topic: [Using the Projector on a Network](#)

Screen Mirroring Restrictions

Note the following when using Screen Mirroring features:

- You cannot project an interlaced image.
- You cannot play audio with more than 3 channels.
- You may not be able to project images depending on the resolution and frame rate.
- You cannot project 3D video.
- You can only play audio saved using the LPCM or AAC-LC audio codec.
- You can only play movies saved using the H.264 or H.265 movie codec (H.265 only supports the Main Profile)

- You cannot use extended Miracast features on Windows 8.1.
- You may not be able to view contents with copyright protection using a Miracast connection.
- Do not change the projector's Screen Mirroring settings during Screen Mirroring projection. Doing so may cause the projector to disconnect and delay reconnection.
- Do not turn off the electrical supply to the projector during Screen Mirroring projection.

Parent topic: [Wireless Network Projection from a Mobile Device or Windows Computer \(Screen Mirroring\)](#)

Selecting Screen Mirroring Settings

You can select Screen Mirroring settings for your projector and then project images from your mobile device.

1. Press the **Menu** button.
2. Select the **Management** menu and press **↵ Enter**.

Frequently Used Items	Management	
Image	User Button	Light Source Mode
Signal I/O	User's Logo	
Installation	User Pattern	
Display	Control Panel Lock	Off
Operation	Color Uniformity	
Management	Refresh Mode	
Network	Light Source Calibration	
Pen/Touch	Date & Time	
Interactive	Schedule Settings	
Multi-Projection	Wireless LAN Power	
Memory	Wireless LAN Diagnosis	1
ECO	Log Save Destination	USB and Internal Memory
Initial/All Settings	Batch Setup Range	
	Language	English
	Information	
	Display Logs	
	Reset Management Settings	
	Network	

3. Set the **Wireless LAN Power** setting to **On**.

4. Select the **Network** menu and press **↵ Enter**.

Frequently Used Items	Network
Image	Wireless LAN Info.
Signal I/O	Wireless LAN Info. IPv6
Installation	Simple AP
Display	Wired LAN Info.
Operation	Wired LAN Info. IPv6
Management	Network Settings
Network	Reset Network Settings
Pen/Touch	Pen/Touch
Interactive	Auto Calibration
Multi-Projection	Manual Calibration
Memory	Touch Unit
ECO	Installation of Projectors
Initial/All Settings	Pen Hovering On
	PC Interactivity
	Reset Pen/Touch Settings
	Interactive
	Drawing Function On

5. Select **Network Settings** and press **↵ Enter**.
6. Select **Priority Control Interface** and press **↵ Enter**.
7. Choose one of the following options:
 - If you are casting images over a wired LAN, select **Wired LAN**.
 - If you are casting images wirelessly directly or via a wireless network router, select **Wireless LAN**.
8. Set the **Simple AP** setting to **On**.
9. Select **Network Projection** and press **↵ Enter**.
10. Set the **Screen Mirroring** setting to **On**.
11. Select these settings as necessary:
 - **Interrupt Connection** lets you connect another mobile device while projecting using Screen Mirroring or to exclusively connect to one device. If you want to use two Screen Mirroring sources, turn this setting off.

- **Adjust Image Quality** lets you adjust the screen mirroring speed and quality. Select a small number to improve the quality or a large number to increase the speed.
- **Capture** lets you capture the projected image and paste it on a page in Whiteboard mode.

Note: If you enable the **Capture** setting, the projector disables HDCP and H.265 codec features. If you disabled the **Capture** setting, you can project HDCP content from the **HDMI Out** port.

- **Screen Mirroring Info** displays connection information when projecting from a Screen Mirroring source.
12. When you finish selecting settings, select **Return** and press **↵ Enter** to return to the **Network Settings** screen.
 13. Select **Set**, and follow the on-screen instructions to save your settings and exit the menus.

Parent topic: [Wireless Network Projection from a Mobile Device or Windows Computer \(Screen Mirroring\)](#)

Connecting for Screen Mirroring with a Windows 8.x/Windows 10 Computer

You can set up your computer to wirelessly project images and play sound using Screen Mirroring.

Note: If you are using Windows 10, you can cast images over a local area network or from your device to the projector directly. When you cast images over a local area network, the connection is more stable and secure. Connect the projector to the network with an Ethernet cable or install the optional wireless LAN module and set the wireless LAN settings to connect to a wireless network.

1. Select the Screen Mirroring settings on your projector as necessary.
2. Press the **LAN** button on the remote control to switch to the Screen Mirroring source.
You see the Screen Mirroring standby screen.
3. Do one of the following:
 - **Windows 10:** Open **Action Center** and select **Connect**.
 - **Windows 8.x:** Select **Devices > Project > Add a wireless display**.
4. Select your projector's Display Name from the list.
5. If you see the PIN entry screen on your computer, enter the PIN code displayed on the Screen Mirroring standby screen or at the bottom right of the projected image.
The projector displays the image from your computer or mobile device.

Note: It may take some time to establish the connection. Do not disconnect the projector's power cord while it is connecting to your device. This may cause your device to freeze or malfunction.

Parent topic: [Wireless Network Projection from a Mobile Device or Windows Computer \(Screen Mirroring\)](#)

Related references

[Optional Equipment and Replacement Parts](#)

[Network Settings - Network Menu](#)

Related tasks

[Selecting Screen Mirroring Settings](#)

Connecting for Screen Mirroring with Miracast

If your mobile device supports Miracast, you can connect it to the projector wirelessly and project images and sound.

1. Select the Screen Mirroring settings on your projector as necessary.
2. Press the **LAN** button on the remote control to switch to the Screen Mirroring source.
You see the Screen Mirroring standby screen.
3. On your mobile device, use the Miracast function to search for the projector.

Note: See your mobile device's documentation for information on accessing the Miracast function.

You see a list of available devices.

4. Select your projector from the list.
5. If you see the PIN entry screen on your mobile device, enter the PIN code displayed on the Screen Mirroring standby screen or at the bottom right of the projected image.

The projector displays the image from your mobile device.

Caution: It may take some time to establish the connection. Do not disconnect the projector's power cord while it is connecting to your device. Doing so may cause your device to freeze or malfunction.

Note: Depending on the mobile device, you may need to delete a device when connecting. Follow the on-screen instructions on your device.

Parent topic: [Wireless Network Projection from a Mobile Device or Windows Computer \(Screen Mirroring\)](#)

Related references

[Network Settings - Network Menu](#)

Related tasks

[Selecting Screen Mirroring Settings](#)

Setting Up Projector Network E-Mail Alerts

You can set up the projector to send you an e-mail alert over the network if there is a problem with the projector.

Note: If the **Standby Mode** setting is set to **Communication On** in the **Operation** menu, you can receive e-mail alerts even if the projector is in standby mode (the power is off). The **Standby Mode** setting is displayed only if the **A/V Output** setting in the Signal I/O menu is set to **While Projecting**.

1. Press the **Menu** button.
2. Select the **Network** menu and press **↵ Enter**.
3. Select **Network Settings** and press **↵ Enter**.
4. Select the **Mail Notification** menu and press **↵ Enter**.

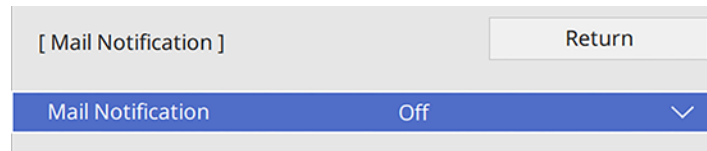

5. Turn on **Mail Notification**.
6. Enter the IP address for the **SMTP Server** setting.

Note: Do not use 127.x.x.x (where x is a number from 0 to 255).

7. Select a type of **Authentication** for the SMTP server.
8. Select a number for the SMTP server **Port Number** setting, from 0 to 65535 (default is 25).
9. Enter a **User Name** for the SMTP server.

10. Enter a **Password** for the SMTP server authentication.
11. Enter the sender's email address as the **From** setting.
12. Choose an **Address** field, enter the e-mail address, and select the alerts you want to receive there. Repeat for up to three addresses. Your e-mail address can be up to 64 alphanumeric characters long.
13. If you are using the PJLink protocol for projector control, turn on the **PJLink** setting in the Projector Control menu and enter the IP address where you want to receive PJLink notifications as the **Notified IP Address** setting.
14. When you finish selecting settings, select **Return** and press **↵ Enter** to return to the **Network Settings** menu.
15. Select **Set**, and follow the on-screen instructions to save your settings and exit the menus.

Note: If a critical problem causes a projector to shut down, you may not receive an e-mail alert.

[Network Projector E-mail Alert Messages](#)

Parent topic: [Using the Projector on a Network](#)

Network Projector E-mail Alert Messages

When a problem occurs with a networked projector, and you selected to receive e-mail alerts, you receive an e-mail containing the following information:

- The email address entered as the **From** setting
- **Epson Projector** on the subject line
- The name of the projector experiencing a problem
- The IP address of the affected projector
- Detailed information about the problem

Note: If a critical problem causes a projector to shut down, you may not receive an e-mail alert.

Parent topic: [Setting Up Projector Network E-Mail Alerts](#)

Setting Up Monitoring Using SNMP

Network administrators can install SNMP (Simple Network Management Protocol) software on network computers so they can monitor projectors. If your network uses this software, you can set up the projector for SNMP monitoring.

1. Press the **Menu** button.
2. Select **Network > Network Settings > Projector Control > SNMP > On**.
3. Enter up to two IP addresses to receive SNMP notifications as the **Trap IP Address** setting, using 0 to 255 for each address field.

Note: To enter the IP address using the numeric keys on the remote control, press and hold the **Num** button. Do not use these addresses: 224.0.0.0 through 255.255.255.255. This projector supports SNMP agent version 1 (SNMPv1).

4. Enter the SNMP **Community Name** (up to 32 alphanumeric characters).
5. When you finish selecting settings, select **Return** and press **↵ Enter** to return to the **Network Settings** menu.
6. Select **Set**, and follow the on-screen instructions to save your settings and exit the menus.

Parent topic: [Using the Projector on a Network](#)

Controlling a Networked Projector Using a Web Browser

Once you have connected your projector to your network, you can select projector settings and control projection using a compatible web browser. This lets you access the projector remotely.

Note: The web setup and control features support Microsoft Internet Explorer 11.0 or later, Microsoft Edge, Google Chrome, and Safari on networks that do not use a proxy server for connection. You can also control the projector using a web browser through the Epson iProjection app. You cannot select all of the projector menu settings or control all projector functions using a web browser.

Note: If you set **Standby Mode** to **Communication On** in the **Operation** menu, you can use a web browser to select settings and control projection even if the projector is in standby mode (the power is off). The **Standby Mode** setting is displayed only if the **A/V Output** setting in the Signal I/O menu is set to **While Projecting**.

1. Make sure the projector is turned on.
2. Start your web browser on a computer or device connected to the network.
3. Type the projector's IP address into the browser's address box and press the computer's **Enter** key (if you are entering an IPv6 address, wrap the address with [and]).

Note: You can find the projector's IP address in the projector's Network menu or on the LAN input screen.

Note: If you attempt to connect to the Web Control screen via a proxy server, the screen will not be displayed. Make a direct connection to the Web Control screen.

You see the Web Control screen.

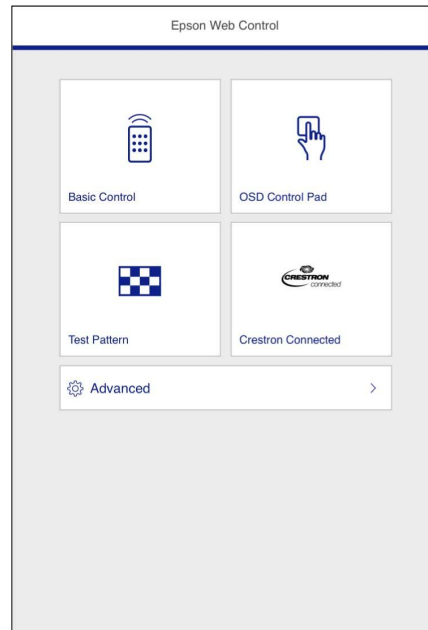

4. To control projection remotely, select the **Basic Control** option from the Web Control screen.

Note: If you see a log in window, enter your user name and password. (The default user name is **EPSONREMOTE** and the default password is **guest**. You can change the password in the projector's Network menu.)

You see a screen like this:

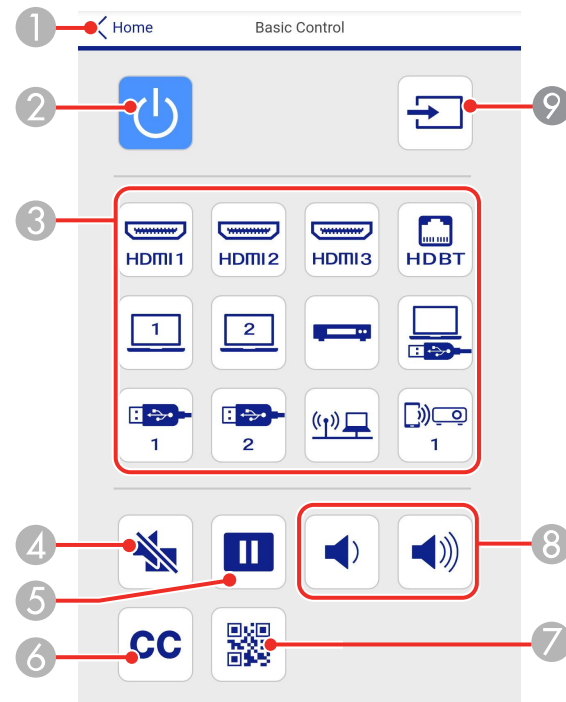

- 1 Returns to the Epson Web Control screen
- 2 Power button control
- 3 Selects the input source
- 4 **A/V Mute** button control
- 5 **Freeze** button control
- 6 Displays closed captions
- 7 Displays a QR code for connecting with iOS or Android devices using the Epson iProjection app
- 8 **Volume** button controls
- 9 Searches for connected sources

5. Select the icon corresponding to the projector function you want to control.
6. To select projector menu settings, select **Advanced** on the Web Control screen.

Note: If you see a log in window, enter your user name and password. (The default user name is **EPSONWEB** and the default password is **admin**. You can change the password in the projector's Network menu.)

7. Select the name of the menu and follow the on-screen instructions.

Parent topic: [Using the Projector on a Network](#)

Creating an Address Book

When sending e-mails from whiteboard mode, you can choose e-mail addresses from an address book. You can create the address book by loading a text file of up to 999 addresses through the web control page.

Note: Addresses are displayed in the order they appear in the text file.

1. Create the text file containing the list of addresses you want to add to the address book. The file must have the following characteristics:
 - Tab-delimited
 - Each line must contain a pair of strings separated by a tab: <name> <tab> <email_address>
 - Each line can contain up to 256 characters
 - Filename with a .txt extension
 - Character code must be Unicode (UTF-16 with BOM)

The text file should look something like this:

```
Joe Smith      xxxxxx@xxxxx.com
Mary Jones-Smith  xxxxxxxx@xxxx.c
John Q. Public xxxx@xxxxxx.com
```

2. Make sure the projector is turned on.
3. Start your web browser on a computer connected to the network.

4. Type the projector's IP address into the browser's address box and press the computer's **Enter** key (if you are entering an IPv6 address, wrap the address with [and]).

Note: You can find the projector's IP address in the projector's Network menu or on the LAN input screen.

5. Enter the user name and password at the prompts.
6. Select **Advanced**.

Note: If you attempt to connect to the Web Control screen via a proxy server, the screen will not be displayed. Make a direct connection to the Web Control screen.

You see the Web Control screen.

7. Select **Interactive > Mail > Address Book File** and browse for the address book file.
8. Select the address book file and select **Send**.

The address book file is uploaded to the projector.

Note: If you need to delete the address book, select **Interactive > Mail > Address Book Settings > Delete Address Book** and select **Execute**.

Parent topic: [Using the Projector on a Network](#)

Using Crestron Connected

If you are using the Crestron Connected network monitoring and control system, you can set up your projector for use on the system. Crestron Connected lets you control and monitor your projector using a web browser.

Note: You cannot use the Message Broadcasting feature in the Epson Projector Management software when you use Crestron Connected.

For additional information on Crestron Connected, contact Crestron.

[Setting Up Crestron Connected](#)

[Controlling a Networked Projector Using Crestron Connected](#)

Parent topic: [Using the Projector on a Network](#)

Setting Up Crestron Connected

To set up your projector for monitoring and control using a Crestron Connected system, make sure your computer and projector are connected to the network.

Note: If you want to use the Crestron Connected system when the projector is turned off, you need to adjust the Standby Mode setting in the Operation menu. The Standby Mode setting is displayed only if the A/V Output setting in the Signal I/O menu is set to **While Projecting**, the Auto Power On setting in the Network menu is set to **Off**, and the Power On Trigger setting in the Operation menu is set to **Plug-in Detection**.

1. Press the **Menu** button.
2. Select the **Network** menu and press **↵ Enter**.
3. Select **Network Settings** and press **↵ Enter**.
4. Select the **Projector Control** menu and press **↵ Enter**.
5. Set the **Crestron Connected** setting to **On** to allow the projector to be detected.

Note: Enabling Crestron Connected disables the Message Broadcasting feature in the Epson Projector Management software.

6. When you are finished selecting settings, select **Return** and press **↵ Enter** to return to the **Network Settings** menu.
7. Select **Set**, and follow the on-screen instructions to save your settings and exit the menus.
8. Turn off the projector, then turn it on again to enable the setting.
9. Start your Web browser on a computer or device connected to the network.
10. Go to the **Epson Web Control** screen by entering the projector's IP address into the browser's address box.
11. Select the **Crestron Connected** settings. See the Crestron Web site for details.

Parent topic: [Using Crestron Connected](#)

Related references

[Input Signal Settings - Signal I/O Menu](#)

[Network Settings - Network Menu](#)

[Feature Settings - Operation Menu](#)

Controlling a Networked Projector Using Crestron Connected

Once you have set up your projector to use Crestron Connected, you can control and monitor projection using a compatible web browser.

1. Start your web browser on a computer connected to the network.
2. Type the projector's IP address into the browser's address box and press the computer's **Enter** key.

You see the Epson Web Control screen:

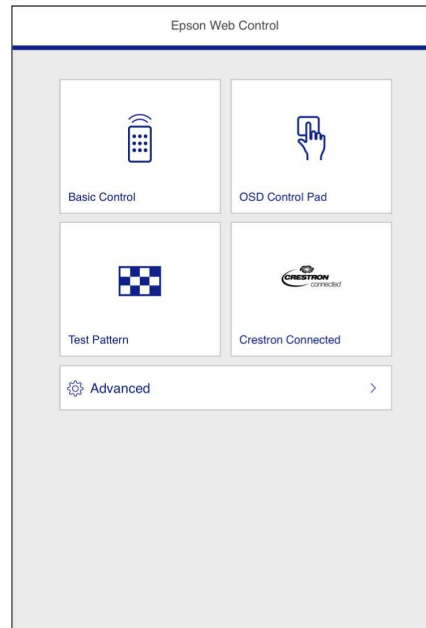

Note: You may need to log in to access some of the options on the Web Control screen. If you see a log in window, enter your user name and password.

3. Select **Crestron Connected**.

You see a screen like this:



Note: Sources in the image above vary depending on ports available on your product.

4. Select the input source that you want to control in the Sources List box. You can scroll through available sources using the up and down arrows in the box.
5. To control projection remotely, click the on-screen buttons that correspond to the projector's remote control buttons. You can scroll through button options at the bottom of the screen.

Note: These on-screen buttons do not directly correspond to the projector's remote control buttons:

- **OK** acts as the **Enter** button
- **Menu** displays the projector's menu

6. To view information about the projector, click the **Info** tab.
7. To change projector, Crestron, and password settings, click the **Tools** tab, select settings on the displayed screen, and click **Send**.
8. When you finish selecting settings, click **Exit** to exit the program.

Parent topic: [Using Crestron Connected](#)

Registering a Digital Certificate on the Projector

Follow the instructions here if you need to install a digital certificate on the projector to provide security for your presentation files.

Note: You can register a digital certificate over a network. However, be sure to register just once or the certificate may not install correctly.

[Importing a Web Server Certificate Using the Projector Menus](#)

[Registering Digital Certificates from a Web Browser](#)

[Digital Certificate Types](#)

Parent topic: [Using the Projector on a Network](#)

Importing a Web Server Certificate Using the Projector Menus

You can create your web server certificate and import it using the projector menus and a USB flash drive.

Note: You can also register digital certificates from your web browser. Make sure to only register once, or the certificate may not install correctly.

1. Make sure your digital certificate file is compatible with projector registration and saved in the root directory of the USB flash drive.
2. Press the **Menu** button on the projector or remote control.
3. Select **Network > Network Settings > Projector Control > Secure HTTP > On**.
4. Select the **Web Server Certificate** setting and press **↵ Enter**.
5. Select **Save** and press **↵ Enter**.
6. Follow the on-screen instructions to connect a USB flash drive to the **USB-A** port on the projector or control pad (BrightLink 1485Fi).
7. Press **↵ Enter** to display the certificate list.
8. Select the certificate you want to import from the displayed list.
A message is displayed prompting you to enter the password for the certificate.
9. Enter the password and press **↵ Enter**.

The certificate is imported and a completion message appears.

Parent topic: [Registering a Digital Certificate on the Projector](#)

Registering Digital Certificates from a Web Browser

You can register the digital certificates on the projector for wireless LAN authentication.

Note: You can also register the digital certificates in the projector's Network menu. However, be sure to register just once or the certificate may not install correctly.

1. Make sure your digital certificate file is compatible with projector registration.
2. Make sure the projector is turned on.
3. Start your web browser on a computer or mobile device connected to the network.
4. Type the projector's IP address into the browser's address box and press the computer's **Enter** key. You see the Web Control screen and a prompt to enter a user ID and password.
5. Select **Advanced** and enter the following information in uppercase or lowercase letters, exactly as shown:
 - For the user ID, enter **EPSONWEB**. (You cannot change the user ID.)
 - For the password, enter the default password **admin**. (You can change the Web Control password using the projector's Network Settings menu.)
6. Under **Network**, select **Certificate**.

Note: You may need to select the  menu icon to find **Network**, depending on your device.

You see a screen like this:

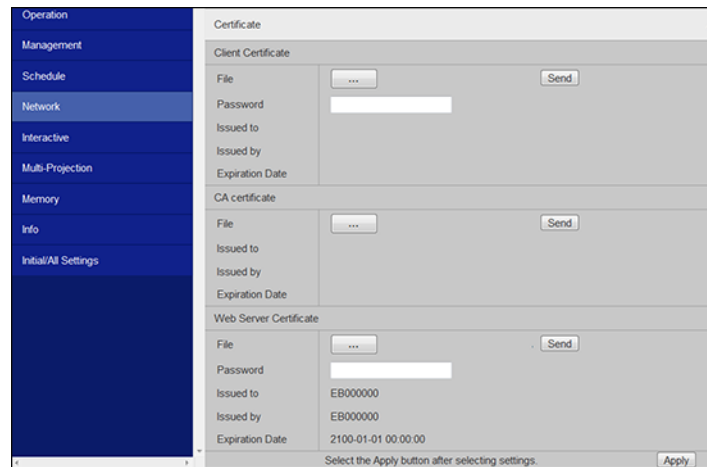

7. Click the **Choose File** button, select the certificate file, and click **Open**.

Note: The button name may vary depending on the browser you are using.

8. Enter a password in the **Password** box and click **Send**.
9. When you finish registering the certificate, click **Apply** to finalize your changes and complete the registration.

Parent topic: [Registering a Digital Certificate on the Projector](#)

Digital Certificate Types

You can register these types of digital certificates.

Client Certificate (PEAP-TLS/EAP-TLS)

Specification	Description
Format	PKCS#12
Extension	PFX, P12
Encryption	RSA

Specification	Description
Hashes	MD5/SHA-1/SHA-256/SHA-384/SHA-512
Key length	512/1024/2048/4096 bit
Password	Up to 64 alphanumeric characters; required

CA Certificate (PEAP/PEAP-TLS/EAP-TLS/EAP-FAST)

Specification	Description
Format	X509v3
Extension	DER/CER/PEM
Encryption	RSA
Hashes	MD5/SHA-1/SHA-256/SHA-384/SHA-512
Key length	512/1024/2048/4096 bit
Encoding	BASE64/Binary

Web Server Certificate (Secure HTTP)

Specification	Description
Format	PKCS#12
Extension	PFX, P12
Encryption	RSA
Hashes	MD5/SHA-1/SHA-256/SHA-384/SHA-512
Key length	512/1024/2048/4096 bit
Common name	Network host name
Organization	Optional
Password	Up to 64 alphanumeric characters; required

Parent topic: [Registering a Digital Certificate on the Projector](#)

Using Basic Projector Features

Follow the instructions in these sections to use your projector's basic features.

[Turning On the Projector](#)

[Turning Off the Projector](#)

[Selecting the Language for the Projector Menus](#)

[Setting the Date and Time](#)

[Image Shape](#)

[Resizing the Image with the Wide and Tele Buttons](#)

[Adjusting the Image Position](#)

[Focusing the Image](#)

[Remote Control Operation](#)

[Selecting an Image Source](#)

[Projection Modes](#)

[Image Aspect Ratio](#)

[Color Mode](#)

[Adjusting the Hue, Saturation, and Brightness](#)

[Adjusting Gamma](#)

[Adjusting the Image Resolution](#)

[Adjusting the Projector's Brightness Level](#)

[Turning On Dynamic Contrast](#)

[Controlling the Volume with the Volume Buttons](#)

[Inverting the Audio Channels](#)

[Selecting a Quick Startup Setting](#)

[Projecting a PC Free Presentation](#)

Turning On the Projector

Turn on the projector before you turn on the computer or video equipment you want to use.

1. Connect the power cord to the projector's power inlet.

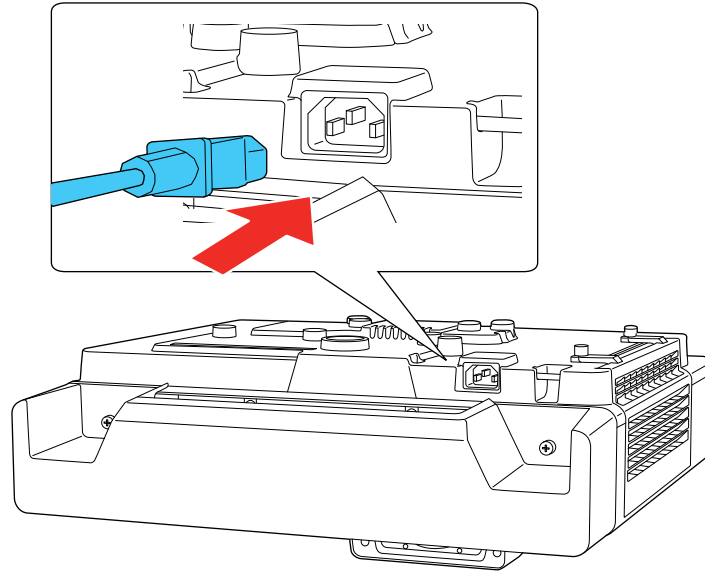

2. Plug the power cord into an electrical outlet.

The projector's power light turns blue. This indicates that the projector is receiving power.

Note: With **Direct Power On** turned on, the projector turns on as soon as you plug it in. If you enable the **Auto Power On** setting in the projector's Operation menu, the projector turns on when it detects a signal or cable connection from the selected port.

3. Press the power button on the projector, control pad (BrightLink 1485Fi), or remote control to turn on the projector.

The projector beeps and the Status light flashes blue as the projector warms up. After about 30 seconds, the Status light stops flashing and turns blue.

Note: When **Quick Startup** is enabled in the projector's Operation menu, the projector becomes ready for use in several seconds the next time you press the power button.

Warning: Never look into the projector lens when the laser is on. This can damage your eyes and is especially dangerous for children and pets. If you are using the remote control to turn the projector on, make sure no one is looking into the lens or in front of the projector before turning it on.

Caution: Make sure no objects are blocking the light from the projector lens. Objects blocking the lens for an extended time can melt and light that is reflected back into the lens can cause the projector to malfunction.

If you do not see a projected image right away, try the following:

- Turn on the connected computer or video device.
- Insert a DVD or other video media and press the play button, if necessary.
- Press the **Source Search** button on the projector or remote control to detect the video source.

Note: If the **Auto Source Search** setting in the Operation menu is enabled, the projector automatically detects the input signal when you turn it on.

- Change the screen output from the computer when using a laptop.
- Press the button for the video source on the remote control.
- If the Home screen is displayed, select the source you want to project.

[Using the Home Screen](#)

Parent topic: [Using Basic Projector Features](#)

Related references

[Feature Settings - Operation Menu](#)

Using the Home Screen

You can select input sources and other frequently used options from the Home screen.

Note: A Touch Unit is optional for the BrightLink 1480Fi and must be installed to enable finger touch operation.

1. To display the Home screen, do one of the following:
 - Press the **Home** button on the control panel or remote control.
 - Turn on the projector with the **Home Screen Auto Disp** setting enabled.
 - Turn on the projector when no signal is received from the selected input source.

2. Press the arrow buttons on the remote control or control panel to navigate the screen, and press **Enter** to select an option. You can also select menu items using the interactive pen or your finger.

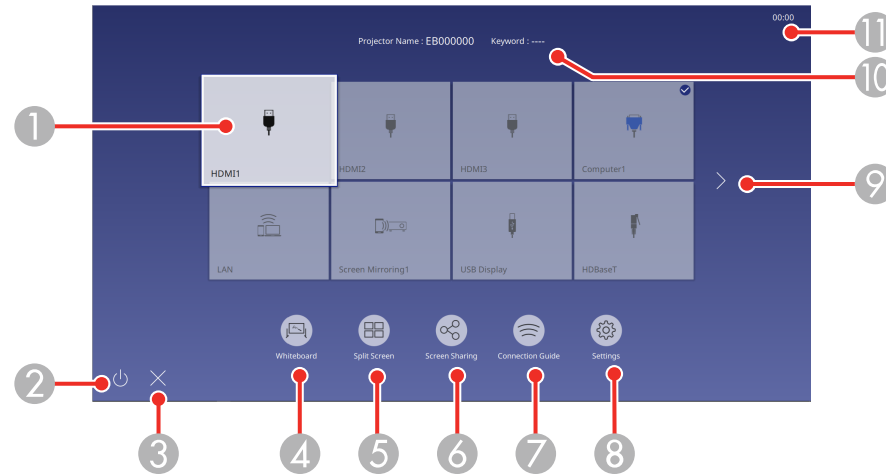

- 1 Selects the source you want to project
A checkmark appears in the upper right corner of the current input source. For most sources, a preview of the input image appears as a thumbnail.
- 2 Turns off the projector
- 3 Closes the Home screen
- 4 Starts Whiteboard mode
- 5 Projects images from two or four input sources simultaneously in a grid format
- 6 Shares your projected image with other projectors connected to the same network
- 7 Displays the Connection Guide
You can view steps for different wireless connection methods depending on the devices you are using, such as smartphones or computers.

- 8 Lets you select the following common projector settings (these settings may vary depending on other selected settings):
 - **Color Mode**
 - **Brightness Level**
 - **Volume**
 - **Geometry Correction (H/V-Keystone and Quick Corner are available)**
 - **Auto Calibration**
 - **Aspect**
- 9 Moves to the previous or next page if there are more available input sources
- 10 Displays the projector name and the projector keyword
- 11 Displays the current time

Note: The Home screen closes after 10 minutes of inactivity.

3. Press the  icon to close the Home screen.

Parent topic: [Turning On the Projector](#)

Turning Off the Projector

Before turning off the projector, shut down any computer connected to it so you can see the computer display during shutdown.

Note: Turn off this product when not in use to prolong the life of the projector. Laser life will vary depending upon mode selected, environmental conditions, and usage. Brightness decreases over time.

1. Press the power button on the projector, control pad, or remote control.
The projector displays a shutdown confirmation screen.

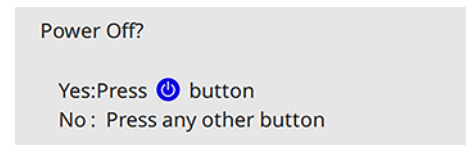

2. Press the power button again. (To leave it on, press any other button.)
The projector beeps twice, the laser turns off, and the Status light turns off.

Note: If the **Light Source Calibration** setting is set to **Run Periodically** in the projector's Management menu, light source calibration starts automatically if you turn off the projector and the following conditions are present:

- 100 hours have passed since the last light source calibration.
 - You have used the projector continuously for at least 20 minutes.
3. To transport or store the projector, make sure the power light is blue (not flashing) and the Status light is off, then unplug the power cord.

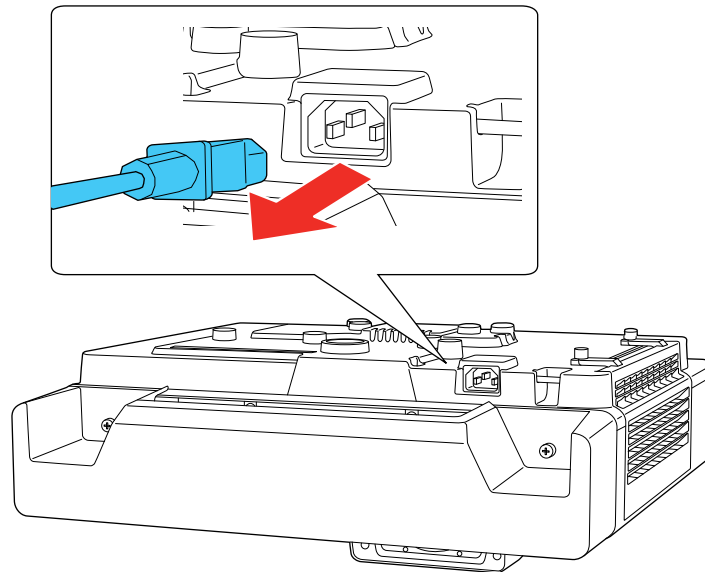

Caution: To avoid damaging the projector or laser, never unplug the power cord when the Status light is on or flashing.

Parent topic: [Using Basic Projector Features](#)

Related references

[Administration Settings - Management Menu](#)

Selecting the Language for the Projector Menus

If you want to view the projector's menus and messages in another language, you can change the Language setting.

1. Turn on the projector.
2. Press the **Menu** button.
3. Select the **Management** menu and press **↵ Enter**.

Frequently Used Items	Management	
Image	User Button	Light Source Mode
Signal I/O	User's Logo	
Installation	User Pattern	
Display	Control Panel Lock	Off
Operation	Color Uniformity	
Management	Refresh Mode	
Network	Light Source Calibration	
Pen/Touch	Date & Time	
Interactive	Schedule Settings	
Multi-Projection	Wireless LAN Power	
Memory	Wireless LAN Diagnosis	1
ECO	Log Save Destination	USB and Internal Memory
Initial/All Settings	Batch Setup Range	
	Language	English
	Information	
	Display Logs	
	Reset Management Settings	
	Network	

4. Select the **Language** setting and press **↵ Enter**.
5. Select the language you want to use and press **↵ Enter**.
6. Press **Menu** or **Esc** to exit the menus.

Parent topic: [Using Basic Projector Features](#)

Setting the Date and Time

You can set the date and time for the projector.

1. Press the **Menu** button.

2. Select the **Management** menu and press **↵ Enter**.
3. Select the **Date & Time** setting and press **↵ Enter**.

You see a screen like this:

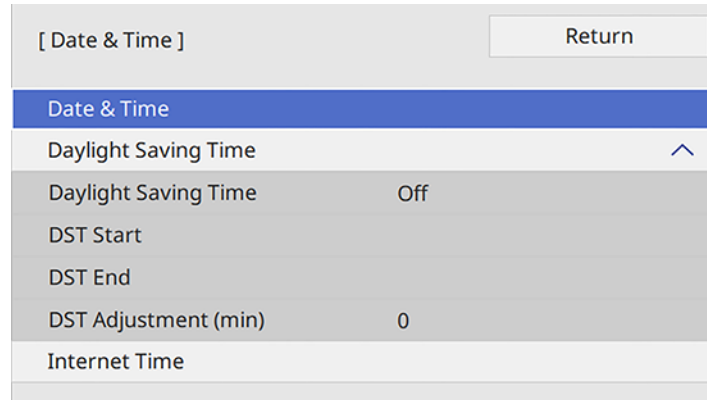

4. Select the **Date & Time** setting and press **↵ Enter**.
5. Select **Date**, press **↵ Enter**, and use the displayed keyboard to enter today's date.
6. Select **Time**, press **↵ Enter**, and use the displayed keyboard to enter the current time.
7. Adjust the **Time Difference (UTC)** settings to set the time difference from the Coordinated Universal Time.
8. When you are finished, select **Set** and press **↵ Enter**.
9. To activate daylight saving time, select the **Daylight Saving Time** setting and set it to **On**. Then select settings.
10. When you are finished, select **Set** and press **↵ Enter**.
11. To update the time automatically through an internet time server, select the **Internet Time** setting and set it to **On**.
12. Select **Internet Time** and press **↵ Enter**.
13. Enter the IP address for the Internet time server you want to use and select **OK**.
14. Select **Set** and press **↵ Enter**.
15. Press **Menu** or **Esc** to exit the menus.

Parent topic: [Using Basic Projector Features](#)

Image Shape

You can project an evenly rectangular image by placing the projector directly in front of the center of the screen and keeping it level. If you place the projector at an angle to the screen, or tilted up or down, or off to the side, you may need to correct the image shape for the best display quality. After correction, your image is slightly smaller.

For the best quality images, try to adjust the projector's position to achieve the correct image size and shape. After you have corrected the position of the projector, you can use the adjustments in this section to correct the image shape. You cannot correct an image shape using multiple correction methods at the same time.

Note: For interactive use, the image must be evenly rectangular, without distortion. Refer to the online *Installation Guide* for instructions on positioning the projector to achieve an evenly rectangular image. After performing any Geometry Correction, you need to calibrate the system again.

[Correcting Image Shape with the Keystone Buttons](#)

[Correcting Image Shape with Quick Corner](#)

[Correcting Image Shape with Arc Correction](#)

[Correcting Image Shape with Point Correction](#)

[Correcting Image Shape with Corner Markers](#)

[Applying Saved Image Shape Settings](#)

Parent topic: [Using Basic Projector Features](#)

Correcting Image Shape with the Keystone Buttons

You can use the projector's keystone correction buttons to correct the shape of an image that is unevenly rectangular on the sides.

Note: You can use the keystone buttons to correct the image up to $\pm 3^\circ$ horizontally or vertically. If the projector is mounted on the wall, use the adjustment dials on the wall mount to correct the screen image before using any other digital correction methods.

Note: If you change the **Screen Type** setting or adjust the image position, your image adjustments are reset.

1. Turn on the projector and display an image.
2. Press one of these keystone buttons on the control panel to display the Keystone adjustment screen.

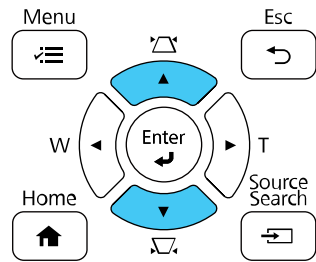

3. Press a keystone button on the projector's control panel to adjust the image shape.

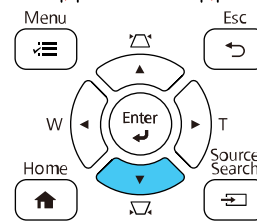
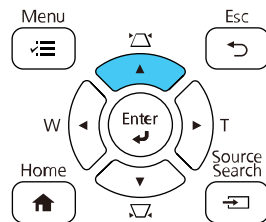
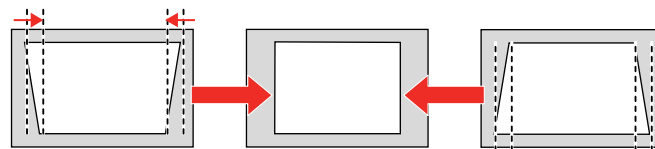
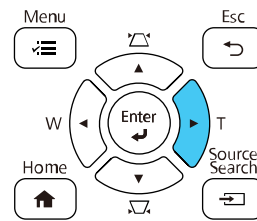
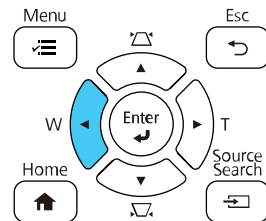
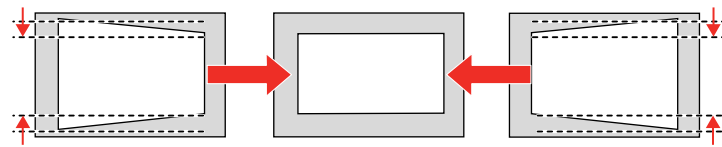

Note: The horizontal keystone adjustment buttons are labeled **W** and **T**.

After correction, your image is slightly smaller.

Note: To save the current image shape, select **Save Memory**. You can save up to three image shapes in the projector's memory.

Note: If the projector is installed out of reach, you can also correct the image shape with the remote control using the **H/V-Keystone** settings in the projector menus.

Parent topic: [Image Shape](#)

Correcting Image Shape with Quick Corner

You can use the projector's Quick Corner setting to correct the shape and size of an image that is unevenly rectangular on all sides.

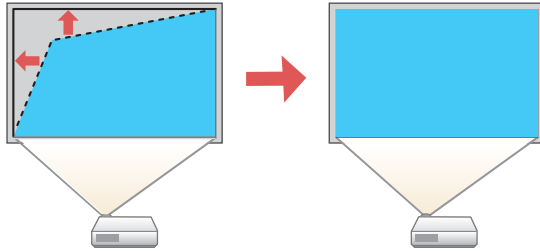

Note: If you change the **Screen Type** setting or adjust the image position, your image adjustments are reset.

1. Turn on the projector and display an image.
2. Press the **Menu** button.

3. Select the **Installation** menu and press **↵ Enter**.

Frequently Used Items	Installation
Image	Fixed Installation Off
Signal I/O	Test Pattern
Installation	Setting Plate Installation Guide
Display	Vertical Installation No
Operation	Projection Front/Upside Down
Management	Auto Screen Adjustment
Network	Geometry Correction Point Correction
Pen/Touch	Digital Zoom
Interactive	Connect ELPCB02 Off
Multi-Projection	Touch Unit
Memory	Remote Receiver Off
ECO	Screen Type 16:9
Initial/All Settings	High Altitude Mode Off
	Reset Installation Settings
	Display
	Pattern Display
	Pattern Type

4. Select the **Geometry Correction** setting and press **↵ Enter**.
5. Select the **Quick Corner** setting and press **Enter**.

Note: You may see a confirmation screen. Select **Yes** and press **Enter** again.

You see the Quick Corner adjustment screen:

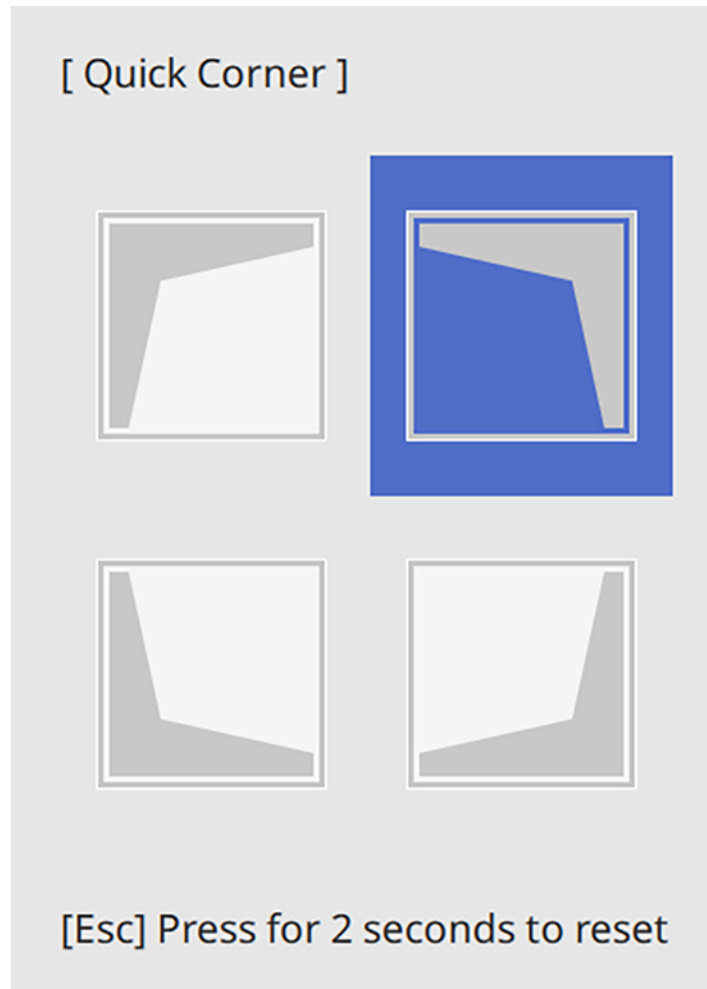

6. Use the arrow buttons on the projector or remote control to select the corner of the image you want to adjust. Then press **Enter**.

Note: To reset your adjustments, press and hold the **Esc** button for at least 2 seconds to display a reset screen. Then select **Yes**.

7. Press the arrow buttons to adjust the image shape as necessary. Press **Enter** to return to the area selection screen.

Note: You can also use the numeric buttons on the remote control to adjust the image shape. If one of the directional arrows on the screen turns gray, you cannot adjust the shape any further in that direction.

8. When you are finished, press **Esc**.

The **Geometry Correction** setting is now set to **Quick Corner** in the projector's Installation menu. If you press the keystone adjustment buttons on the control panel, the area selection screen appears.

Note: To save the current image shape, select **Save Memory**. You can save up to three image shapes in the projector's memory.

Parent topic: [Image Shape](#)

Correcting Image Shape with Arc Correction

You can use the projector's Arc Correction setting to adjust the curve or arc of the sides of your image.

Note: If you change the **Screen Type** setting or adjust the image position, your image adjustments are reset.

1. Turn on the projector and display an image.
2. Press the **Menu** button.
3. Select the **Installation** menu and press **↵ Enter**.

Frequently Used Items	Installation	
Image	Fixed Installation	Off
Signal I/O	Test Pattern	
Installation	Setting Plate Installation Guide	
Display	Vertical Installation	No
Operation	Projection	Front/Upside Down
Management	Auto Screen Adjustment	
Network	Geometry Correction	Point Correction
Pen/Touch	Digital Zoom	▼
Interactive	Connect ELPCB02	Off
Multi-Projection	Touch Unit	
Memory	Remote Receiver	Off
ECO	Screen Type	16:9 ▼
Initial/All Settings	High Altitude Mode	Off
	Reset Installation Settings	
	Display	
	Pattern Display	
	Pattern Type	

4. Select the **Geometry Correction** setting and press **↵ Enter**.
5. Select the **Arc Correction** setting and press **↵ Enter**. Then select the **Arc Correction** setting and press **↵ Enter** again.

You see the Arc Correction adjustment screen:

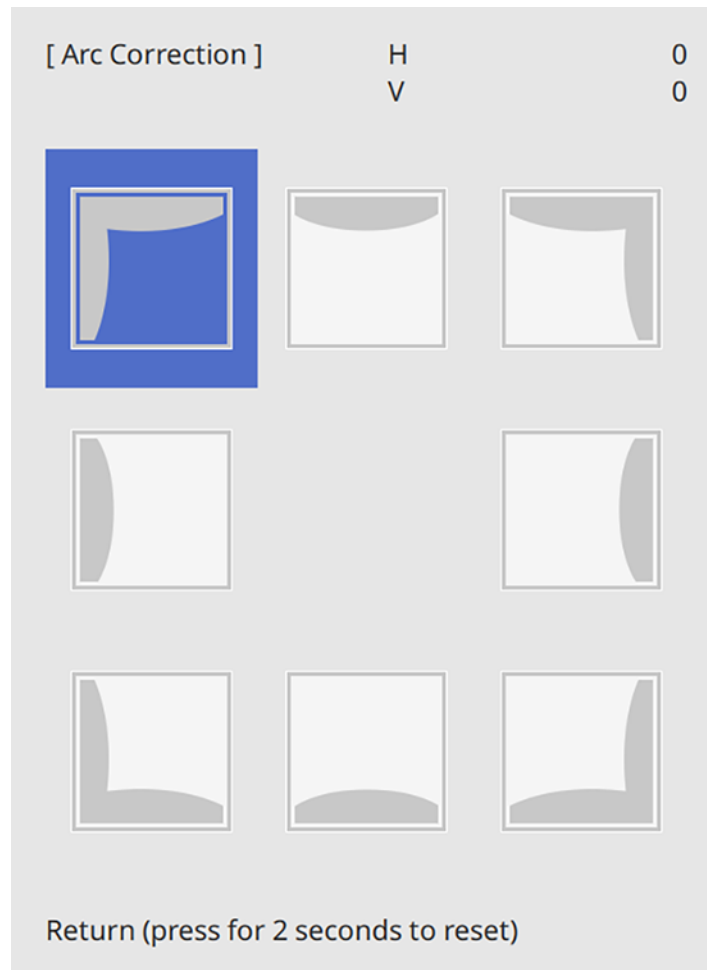

Note: To reset your adjustments, press the **Esc** button for at least 2 seconds to display a reset screen, and select **Yes**.

6. Use the arrow buttons on the projector or the remote control to select the corner or side of the image you want to adjust. Then press **↵ Enter**.
7. Press the arrow buttons to adjust the image shape as necessary.

8. When you are finished, press **Esc**.

Note: To save the current image shape, select **Memory > Save Memory**. You can save up to three image shapes in the projector's memory.

Parent topic: [Image Shape](#)

Related references

[The Whiteboard Toolbar](#)

Correcting Image Shape with Point Correction

You can use the projector's Point Correction feature to fine-tune the image shape using points on a grid. This is useful for adjusting overlapping areas in multiple projected images that do not line up correctly.

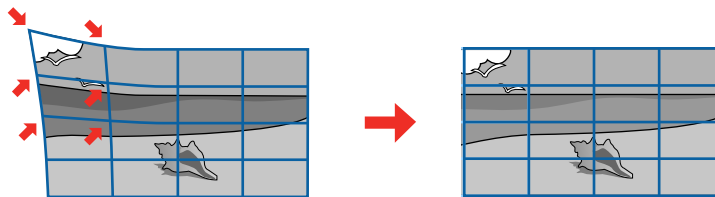

1. Turn on the projector and display an image.
2. Press the **Menu** button.
3. Select **Installation > Geometry Correction > Point Correction**.

Note: If you see a confirmation message, select **Yes** and press **↵ Enter**.

4. Select the **Point Correction** setting again and press **↵ Enter**.
5. Select the number of grid lines to display and press **↵ Enter**.

You see a grid on the projected image.

Note: If you need to change the color of the grid lines, press **Esc**, select the **Pattern Color** setting, and select a suitable color.

6. Press the arrow buttons on the projector or remote control to move to the point on the grid that you want to adjust. Then press **↵ Enter**.

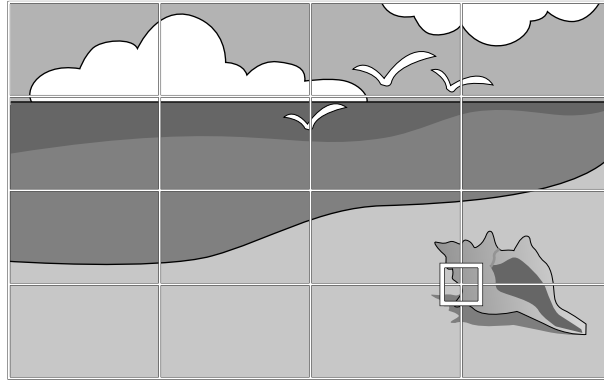

7. Press the arrow buttons as necessary to correct the image shape.

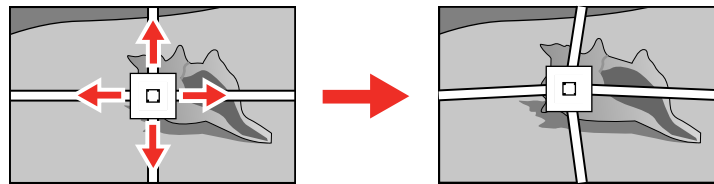

8. Press **Esc** to return to the previous screen and select another point to correct, if necessary.
9. When you are finished, press the **Menu** button.

Note: If necessary, you can fine-tune your image adjustments using the **Quick Corner** setting.

Parent topic: [Image Shape](#)

Related tasks

[Correcting Image Shape with Quick Corner](#)

Correcting Image Shape with Corner Markers

If you have installed corner markers on the projection surface, you can use the projector's **Auto Screen Adjustment** setting to correct the image shape automatically.

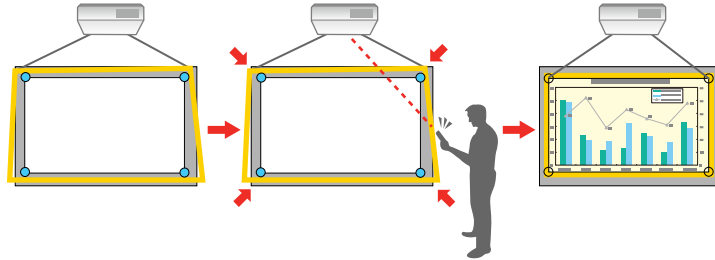

Note: The projected image needs to be 110 inches (279.4 cm) or less diagonally to use the Auto Screen Adjustment. Make sure the projector is squarely facing the projection surface. Auto Screen Adjustment may not work if your image surface:

- Is not flat.
- Is patterned.
- Is dirty.
- Has obstructions or objects on the image surface.

Note: The projector includes 4 magnets and 4 stickers for Auto Screen Adjustment. If your projection surface is magnetic, attach the stickers to the magnets. If your projection surface isn't magnetic, attach the stickers directly to the projection surface. If you attach the stickers directly to the surface, they can only be used once.

Note: Before performing Auto Screen Adjustment, set the screen type setting. The adjustments reset when you change the **Screen Type**. You may not be able to correct the image shape correctly when you shift the image.

1. Press the **Menu** button.

2. Select the **Installation** menu and press **↵ Enter**.

Frequently Used Items	Installation
Image	Fixed Installation Off
Signal I/O	Test Pattern
Installation	Setting Plate Installation Guide
Display	Vertical Installation No
Operation	Projection Front/Upside Down
Management	Auto Screen Adjustment
Network	Geometry Correction Point Correction
Pen/Touch	Digital Zoom
Interactive	Connect ELPCB02 Off
Multi-Projection	Touch Unit
Memory	Remote Receiver Off
ECO	Screen Type 16:9
Initial/All Settings	High Altitude Mode Off
	Reset Installation Settings
	Display
	Pattern Display
	Pattern Type

3. Select the **Auto Screen Adjustment** setting and press **↵ Enter**.
You see a guide screen.
4. Follow the on-screen instructions to adjust the position of the projected image so that the corner markers appear just inside the yellow area.
5. Press **↵ Enter**.
A guide pattern appears and the projector starts adjusting the image shape.

Note: If necessary, you can fine-tune your image adjustments using the **Quick Corner** setting.

Parent topic: [Image Shape](#)

Related tasks

[Correcting Image Shape with Quick Corner](#)

Applying Saved Image Shape Settings

You can load the image shape settings you selected and saved to the projector's memory and apply them to the current image.

1. Turn on the projector and display an image.
2. Hold down the **Num** button on the remote control and press the number button (1, 2, or 3) that matches the number of the saved image shape setting.

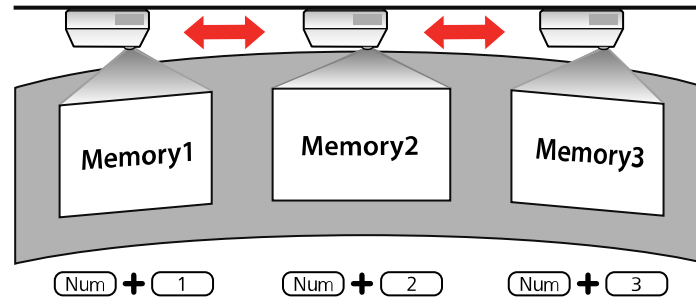

The saved image shape setting is applied and you are prompted to calibrate the screen.

3. Follow the on-screen instructions to calibrate the screen.

Parent topic: [Image Shape](#)

Resizing the Image with the Wide and Tele Buttons

You can resize the image using the Wide and Tele buttons. Wait at least 30 minutes after you start projecting to adjust the image size.

1. Turn on the projector and display an image.
2. To enlarge the image size, press the **W** (Wide) button on the projector's control panel.

3. To reduce the image size, press the **T** (Tele) button.

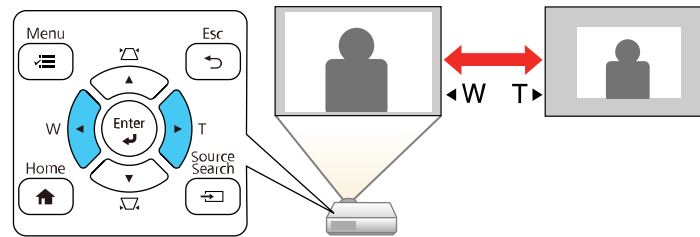

After you adjust the image size, the Image Shift screen is displayed automatically for adjusting the image position.

Note: If the projector is installed out of reach, you can also adjust the image size with the remote control using the **Digital Zoom** setting in the projector menus.

Parent topic: [Using Basic Projector Features](#)

Related references

[Installation Settings - Installation Menu](#)

Adjusting the Image Position

You can use the Image Shift feature to adjust the image position without moving the projector. Wait at least 30 minutes after you start projecting to adjust the image position.

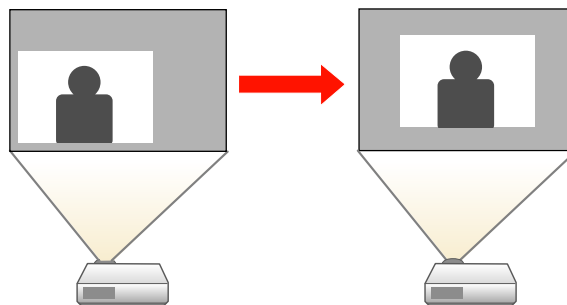

Note: This feature is not available if the **Zoom** option is set to the widest setting.

1. Turn on the projector and display an image.
2. Adjust the image size using the **W** (Wide) and **T** (Tele) buttons.
After you adjust the image size, the Image Shift screen is displayed automatically.

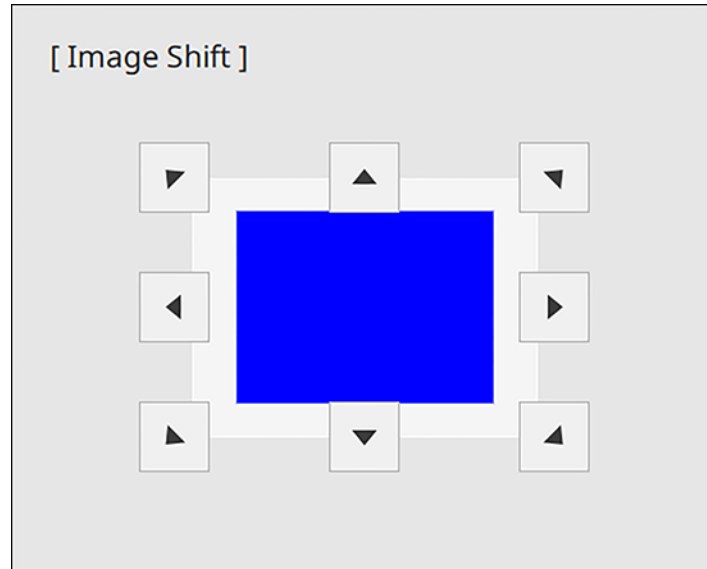

3. Use the arrow buttons on the projector or remote control to adjust the image position.
Note: You can also use the Installation menu to adjust the **Image Shift** setting.
4. Press **Esc** to close the Image Shift screen. The screen closes if no operation is performed for approximately 10 seconds.

Note: The Image Shift setting is retained even if the projector is turned off; however, you need to readjust the image position if you change the projector's location or angle.

Parent topic: [Using Basic Projector Features](#)

Related references

[Installation Settings - Installation Menu](#)

Focusing the Image

Wait at least 30 minutes after you start projecting to adjust the focus.

1. Turn on the projector and display an image.
2. Press the **Menu** button.
3. Select the **Installation** menu and press **↵ Enter**.

Frequently Used Items	Installation
Image	Fixed Installation Off
Signal I/O	Test Pattern
Installation	Setting Plate Installation Guide
Display	Vertical Installation No
Operation	Projection Front/UpSide Down
Management	Auto Screen Adjustment
Network	Geometry Correction Point Correction
Pen/Touch	Digital Zoom
Interactive	Connect ELPCB02 Off
Multi-Projection	Touch Unit
Memory	Remote Receiver Off
ECO	Screen Type 16:9
Initial/All Settings	High Altitude Mode Off
	Reset Installation Settings
	Display
	Pattern Display
	Pattern Type

4. Select **Test Pattern** and press ↵ **Enter**.
5. Open the front cover.

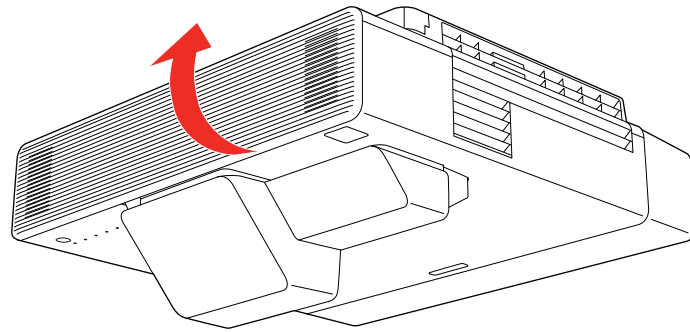

6. Move the focus lever and adjust the focus using the center reference point of the projected screen.

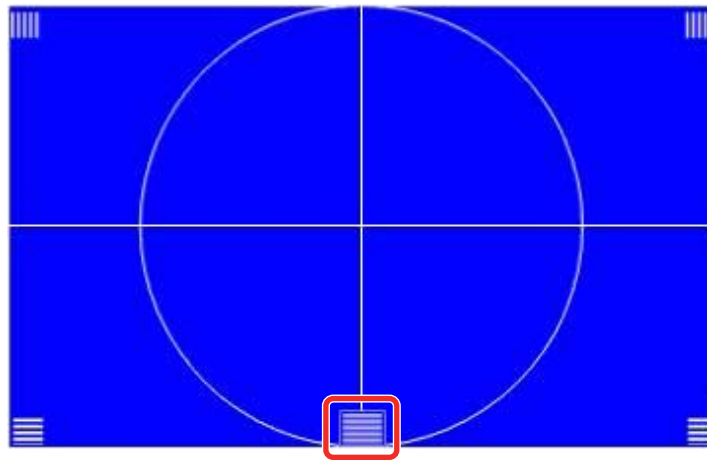
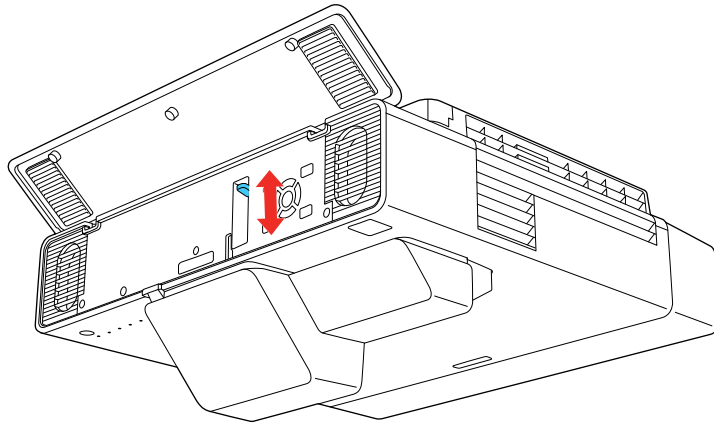

Note: You may see a different test pattern than the one shown above.

7. Once the center reference point is in focus, check that the corner reference points are also in focus.

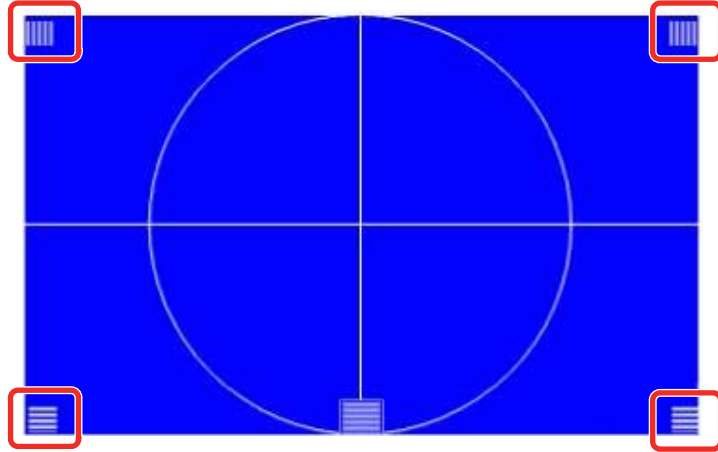

Note: If any areas are out of focus, use the focus lever to adjust the focus until the corners appear the same.

8. To remove the test pattern, press **Esc**.

Parent topic: [Using Basic Projector Features](#)

Remote Control Operation

The remote control lets you control the projector from almost anywhere in the room, up to 19.7 feet (6 m) away. You can point it at the screen or board, or the front or back of the projector.

Make sure that you aim the remote control at the projector's receivers within the angles listed here.

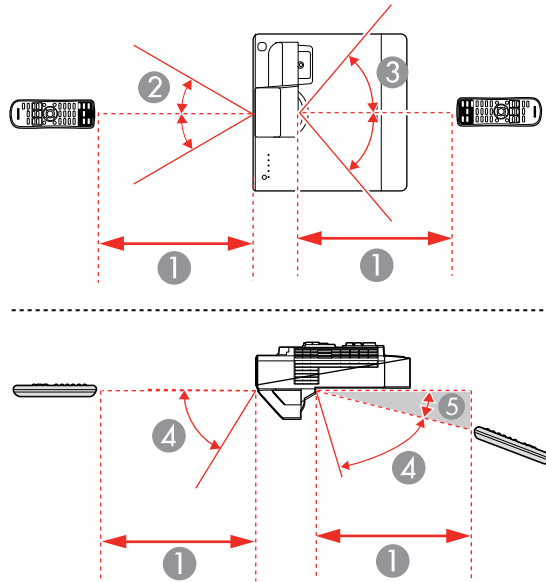

- 1 19.7 feet (6 m)
- 2 $\pm 30^\circ$
- 3 $\pm 55^\circ$
- 4 60°
- 5 15°

Note: Avoid using the remote control in conditions with bright fluorescent lights or in direct sunlight, or the projector may not respond to commands. If you will not use the remote control for a long time, remove the batteries.

Parent topic: [Using Basic Projector Features](#)

Selecting an Image Source

If you connected multiple image sources to the projector, such as a computer and DVD player, you may want to switch from one image source to the other.

Note: If you turned on the **Auto Source Search** setting in the Operation menu, the projector automatically switches to another detected image source if the signal to the current image source is lost.

1. Make sure the connected image source you want to use is turned on.
2. For video image sources, insert a DVD or other video media and press its play button, if necessary.
3. Do one of the following:
 - Press the **Source Search** button on the projector or remote control until you see the image from the source you want.

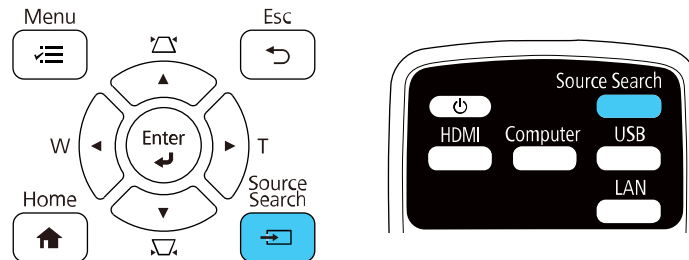

- Press the button for the source you want on the remote control. If there is more than one port for that source, press the button again to cycle through the sources.

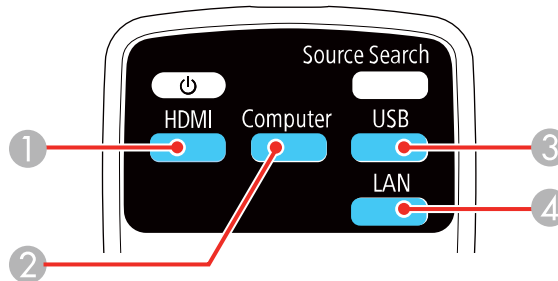

- 1 HDMI, Video, and HDBaseT (BrightLink 1485Fi) sources
- 2 VGA port sources
- 3 USB port sources (computer display or external devices)
- 4 Network and Screen Mirroring sources

- Press the button for the HDMI source you want on the control pad (BrightLink 1485Fi).

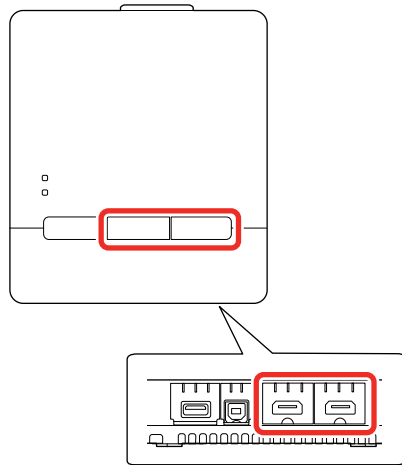

- Press the **Home** button on the remote control or projector and select your image source.

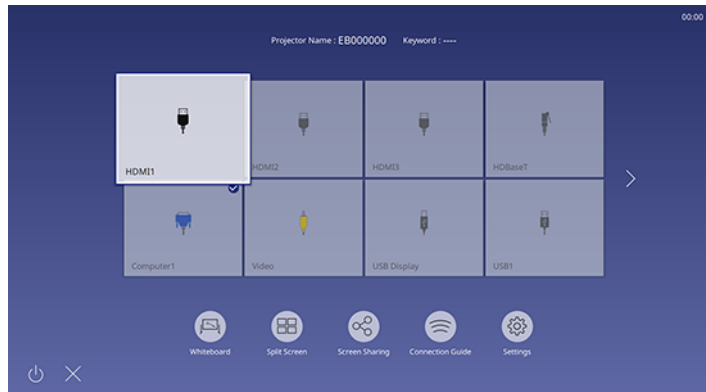

Note: Your Home screen may look different from the illustration shown here. A checkmark appears on the image from the current input source. You can see thumbnail previews of most input sources.

The displayed order of the input sources changes. Detected input sources appear in the upper left position. You can set the order of the input sources using the **Sort Source Thumbnails** setting in the projector's Display menu.

Parent topic: [Using Basic Projector Features](#)

Related references

[Feature Settings - Operation Menu](#)

Related tasks

[Using the Home Screen](#)

Projection Modes

Depending on how you positioned the projector, you may need to change the projection mode so your images project correctly.

- **Front** lets you project from a table in front of the screen.
- **Front/Upside Down** flips the image over top-to-bottom to project upside-down from a wall or ceiling mount.
- **Rear** flips the image horizontally to project from behind a translucent screen.
- **Rear/Upside Down** flips the image over top-to-bottom and horizontally to project from the wall or ceiling and behind a translucent screen.

You can change the projection mode using the remote control or by changing the **Projection** setting in the **Installation** menu.

[Changing the Projection Mode Using the Remote Control](#)

[Changing the Projection Mode Using the Menus](#)

Parent topic: [Using Basic Projector Features](#)

Changing the Projection Mode Using the Remote Control

You can change the projection mode to flip the image over top-to-bottom.

1. Turn on the projector and display an image.

2. Hold down the **A/V Mute** button on the remote control for 5 to 10 seconds.

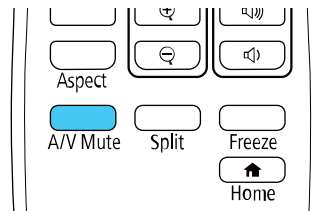

The image disappears briefly and reappears flipped top-to-bottom.

3. To change projection back to the original mode, hold down the **A/V Mute** button for 5 to 10 seconds again.

Parent topic: [Projection Modes](#)

Changing the Projection Mode Using the Menus

You can change the projection mode to flip the image over top-to-bottom and/or left-to-right using the projector menus.

1. Turn on the projector and display an image.
2. Press the **Menu** button.

3. Select the **Installation** menu and press **↵ Enter**.

Frequently Used Items	Installation
Image	Fixed Installation Off
Signal I/O	Test Pattern
Installation	Setting Plate Installation Guide
Display	Vertical Installation No
Operation	Projection Front/Upside Down
Management	Auto Screen Adjustment
Network	Geometry Correction Point Correction
Pen/Touch	Digital Zoom
Interactive	Connect ELPCB02 Off
Multi-Projection	Touch Unit
Memory	Remote Receiver Off
ECO	Screen Type 16:9
Initial/All Settings	High Altitude Mode Off
	Reset Installation Settings
	Display
	Pattern Display
	Pattern Type

4. Select the **Projection** setting and press **Enter**.
5. Select a projection mode and press **Enter**.
6. Press **Menu** or **Esc** to exit the menus.

Parent topic: [Projection Modes](#)

Image Aspect Ratio

The projector can display images in different width-to-height ratios called aspect ratios. Normally the input signal from your video source determines the image's aspect ratio. However, for certain images you can change the aspect ratio to fit your screen by pressing a button on the remote control.

If you always want to use a particular aspect ratio for a certain video input source, you can select it using the projector's menus.

[Changing the Image Aspect Ratio](#)

[Available Image Aspect Ratios](#)

Parent topic: [Using Basic Projector Features](#)

Changing the Image Aspect Ratio

You can change the aspect ratio of the displayed image to resize it.

Note: Set the **Screen Type** setting in the projector's Installation menu before changing the aspect ratio.

Note: This setting is available only when the **Scale** setting is turned off or the **Scale Mode** setting is set to **Full Display** (BrightLink 1485Fi).

1. Turn on the projector and switch to the image source you want to use.
2. Press the **Aspect** button on the remote control.

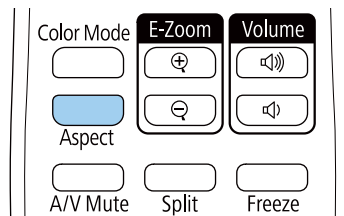

The shape and size of the displayed image changes, and the name of the aspect ratio appears briefly on the screen.

3. To cycle through the available aspect ratios for your input signal, press the **Aspect** button repeatedly.

Note: To remove black bars when projecting from a computer, set the **Resolution** setting to **Wide** or **Normal** in the Image menu, depending on your computer's resolution.

Parent topic: [Image Aspect Ratio](#)

Related references

[Image Quality Settings - Image Menu](#)

Available Image Aspect Ratios

You can select the following image aspect ratios, depending on the selected **Screen Type** setting and input signal from your image source.

Note: Black bands and cropped images may project in certain aspect ratios, depending on the aspect ratio and resolution of your input signal.

Aspect ratio setting	Description
Auto	Automatically sets the aspect ratio according to the input signal and the Resolution setting.
Full	Displays images using the full width of the projection area, but does not maintain the aspect ratio.
Zoom	Displays images using the full width of the projection area and maintains the aspect ratio of the image.
Native	Displays images as is (aspect ratio and resolution are maintained).

Note: The appearance of the **Native** image aspect ratio setting varies depending on the input signal.

If there are margins between the image edges and the screen, you can adjust the position of the projected image using the **Screen Position** setting in the Installation menu.

Parent topic: [Image Aspect Ratio](#)

Color Mode

The projector offers different Color Modes to provide optimum brightness, contrast, and color for a variety of viewing environments and image types. You can select a mode designed to match your image and environment, or experiment with the available modes.

If you always want to use a particular color mode for a certain video input source, you can select it using the projector menus.

[Changing the Color Mode](#)

[Available Color Modes](#)

Parent topic: [Using Basic Projector Features](#)

Changing the Color Mode

You can change the projector's Color Mode using the remote control to optimize the image for your viewing environment.

1. Turn on the projector and switch to the image source you want to use.

- If you are projecting from a DVD player or other video source, insert a disc or other video media and press the play button, if necessary.
- Press the **Color Mode** button on the remote control to change the Color Mode.

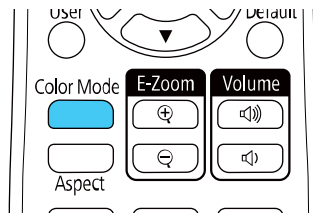

The image appearance changes and the name of the Color Mode appears briefly on the screen.

- To cycle through all the available Color Modes for your input signal, press the **Color Mode** button repeatedly.

Parent topic: [Color Mode](#)

Available Color Modes

You can set the projector to use these Color Modes, depending on the input source you are using:

Color Mode	Description
Presentation	Best for color presentations in a bright room
Dynamic	Best for video games in a bright room
Cinema	Best for movies projected in a dark room with natural tone images
sRGB	Best for standard sRGB computer displays
Blackboard	Best for projecting images directly on a green chalkboard
DICOM SIM	Best for projecting X-rays and other medical images (shows clear shadows)
Multi-Projection (BrightLink 1485Fi)	Best for projecting from multiple projectors (reduces the color tone difference between images)

Note: The **DICOM SIM** color mode is for reference purposes only and should not be used to make medical diagnoses.

Parent topic: [Color Mode](#)

Adjusting the Hue, Saturation, and Brightness

You can adjust the hue, saturation, and brightness settings for individual image colors.

1. Turn on the projector and switch to the image source you want to use.
2. Press the **Menu** button.
3. Select the **Image** menu and press **↵ Enter**.

Frequently Used Items	Image	
Image	Color Mode	Presentation
Signal I/O	Brightness	50
Installation	Contrast	50
Display	Color Saturation	50
Operation	Tint	50
Management	Sharpness	50
	White Balance	
Network	Dynamic Contrast	Off
Pen/Touch	Noise Reduction	0
Interactive	MPEG Noise Reduction	Off
Multi-Projection	Gamma	0
Memory	RGBCMY	
ECO	Deinterlacing	Off
Initial/All Settings	Super-resolution	
	Detail Enhancement	
	Reset to Defaults	
	Source	Computer1
	Resolution	Auto

4. Select **RGBCMY** and press **↵ Enter**.

5. Select the color to adjust and press **↵ Enter**.

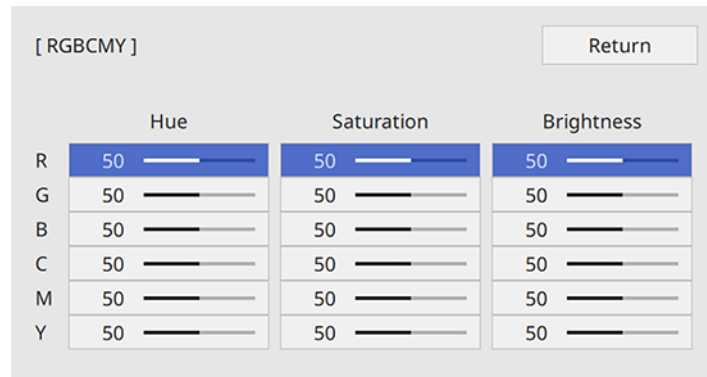

6. Do the following as necessary for each setting:
- To adjust the overall hue of the color (bluish, greenish, reddish), adjust the **Hue** setting.
 - To adjust the overall vividness of the color, adjust the **Saturation** setting.
 - To adjust the overall brightness of the color, adjust the **Brightness** setting.

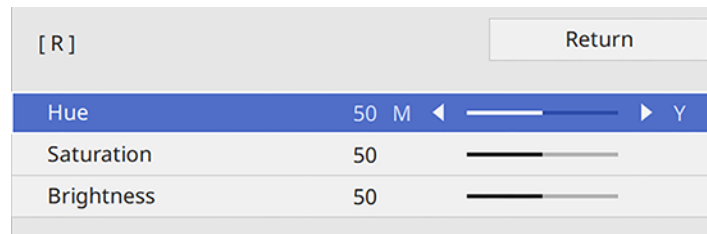

7. Press **Menu** or **Esc** to exit the menus.

Parent topic: [Using Basic Projector Features](#)

Adjusting Gamma

You can adjust the gamma to improve differences in halftone brightness that vary depending on the connected device.

Note: Project a still image to adjust the gamma; you cannot adjust it properly when projecting a movie or other moving video. Medical images may not reproduce correctly depending on your operating environment and screen.

1. Turn on the projector and switch to the image source you want to use.
2. Press the **Menu** button.
3. Select the **Image** menu and press **↵ Enter**.
4. Select the **Gamma** setting and press **↵ Enter**.
5. Select and adjust the correction value.

You see a screen like this:

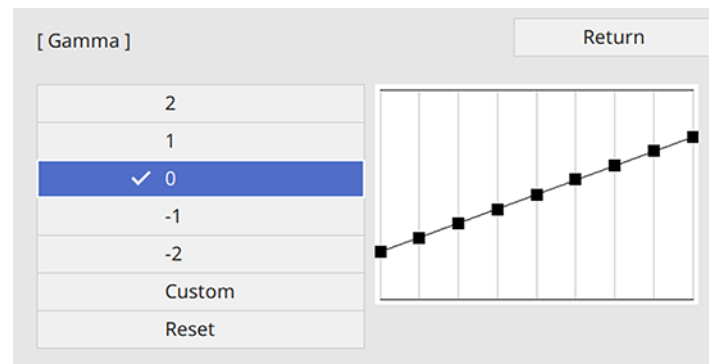

When you select a smaller value, you can reduce the overall brightness of the image to make the image sharper. When you select a larger value, the dark areas of images become brighter, but the color saturation for lighter areas may become weaker.

Note: If you set the **Color Mode** setting to **DICOM SIM** in the projector's **Image** menu, select the adjustment value according to the projection size. If the projection size is 80 inches (203 cm) or less, select a small value. If the projection size is 80 inches or more, select a large value.

6. If you want to make finer adjustments, select **Custom** and press **↵ Enter**.
7. Press the left or right arrow button to select the tone you want to change, then press the up or down arrow button to adjust the tone and press **↵ Enter**.

You see a screen like this:

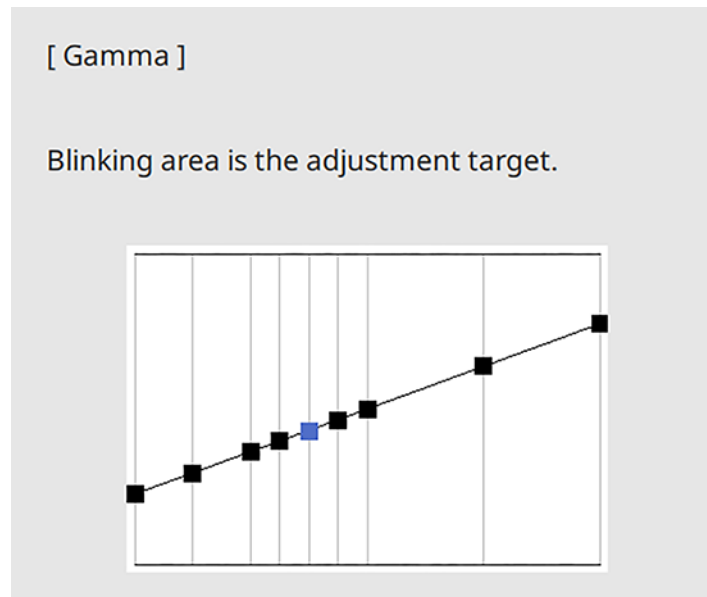

8. Press **Menu** or **Esc** to exit the menus.

Parent topic: [Using Basic Projector Features](#)

Adjusting the Image Resolution

You can adjust the image resolution to project a clear image with an emphatic texture and material feel.

1. Turn on the projector and switch to the image source you want to use.
2. Press the **Menu** button.

3. Select the **Image** menu and press **↵ Enter**.

Frequently Used Items	Image	
Image	Color Mode	Presentation
Signal I/O	Brightness	50
Installation	Contrast	50
Display	Color Saturation	50
Operation	Tint	50
Management	Sharpness	50
Network	White Balance	
Pen/Touch	Dynamic Contrast	Off
Interactive	Image Enhancement	
Memory	Gamma	0
ECO	RGBCMY	
Initial/All Settings	Reset to Defaults	
	Source	Computer1
	Resolution	Auto
	Aspect	Auto
	Analog Signal Adjustment	
	Reset to Defaults	
	Reset Image Settings	

4. Select **Image Enhancement** and press **↵ Enter**.
5. Select **Image Preset Mode** and press **↵ Enter**.
6. Select the preset option and press **↵ Enter**.

Note: The following settings saved in the preset option are applied to the image:

- **Noise Reduction**
- **MPEG Noise Reduction**
- **Deinterlacing**
- **Super-resolution**
- **Detail Enhancement**

7. Adjust each setting in the projector's Image menu individually as necessary.
 - Adjust the **Noise Reduction** setting to reduce flickering in images.
 - Adjust the **MPEG Noise Reduction** setting to reduce the noise or artifacts seen in MPEG video.

- Adjust the **Deinterlacing** setting to convert interlaced-to-progressive signals for certain video image types (only displayed when the current signal is interlaced [480i/576i/1080i]).
- Adjust the **Super-resolution** setting to reduce blurring when projecting low-resolution images.
- Adjust the **Detail Enhancement** setting to create a more emphatic texture and material feel of the image.

The setting values in the preset option are overwritten as you make changes.

8. Press **Menu** or **Esc** to exit the menus.

Parent topic: [Using Basic Projector Features](#)

Adjusting the Projector's Brightness Level

You can adjust the brightness of your projector's light source.

1. Turn on the projector and switch to the image source you want to use.
2. Press the **Menu** button.
3. Select the **Operation** menu and press **↵ Enter**.

Frequently Used Items	Operation
Image	Auto Source Search On
Signal I/O	Light Source Brightness Cont...
Installation	Direct Power On Off
Display	Auto Power On Off
Operation	Sleep Mode On ^
Management	Sleep Mode Timer 10 min.
Network	A/V Mute Timer On
Pen/Touch	Standby Mode Communication On ^
Interactive	Port Wired LAN
Multi-Projection	Quick Startup Off
Memory	Indicators On
ECO	Inv Direction Button Off
Initial/All Settings	Reset Operation Settings
	Management
	User Button Light Source Mode
	User's Logo
	User Pattern

4. Select **Light Source Brightness Control** and press **↵ Enter**.

[Light Source Brightness Control]	Return
Maintain Brightness	On
Maintain Brightness Level	100 %
Estimated Remains	0H 
Light Source Mode	Normal
Brightness Level	100 %

5. If you want to maintain the brightness at a specific level, select the **Maintain Brightness** setting and select **On**.
6. If you turn on **Maintain Brightness**, select the **Maintain Brightness Level** setting and check the **Estimated Remains** information.
7. If you turn off **Maintain Brightness**, select the **Light Source Mode** setting:
 - **Normal**: Sets brightness to the maximum level (ideal for conference rooms, auditoriums, and lecture halls)
 - **Quiet**: Sets brightness to 70% and reduces fan noise (ideal for libraries, theaters, museums, and art galleries)
 - **Extended**: Sets brightness to 70% and extends the life expectancy of the light source (ideal for darker environments with ambient light, such as museums and art galleries, where a reduced maintenance cycle is desired)
 - **Custom**: Allows you to select a custom brightness level between 70 to 100%
8. If you set the **Light Source Mode** setting to **Custom**, select **Brightness Level** and use the left and right arrow buttons to select the brightness.
9. Press **Menu** or **Esc** to exit the menus.

Note: For the best results in maintaining the brightness level, set the **Light Source Calibration** setting to **Run Periodically** in the projector's Management menu.

[Constant Brightness Usage Hours](#)

Parent topic: [Using Basic Projector Features](#)

Related references

[Administration Settings - Management Menu](#)

Related tasks

[Saving a Scheduled Event](#)

Constant Brightness Usage Hours

If you turn on the **Maintain Brightness** setting, the number of hours the projector can maintain constant brightness is displayed as the **Estimated Remains** setting.

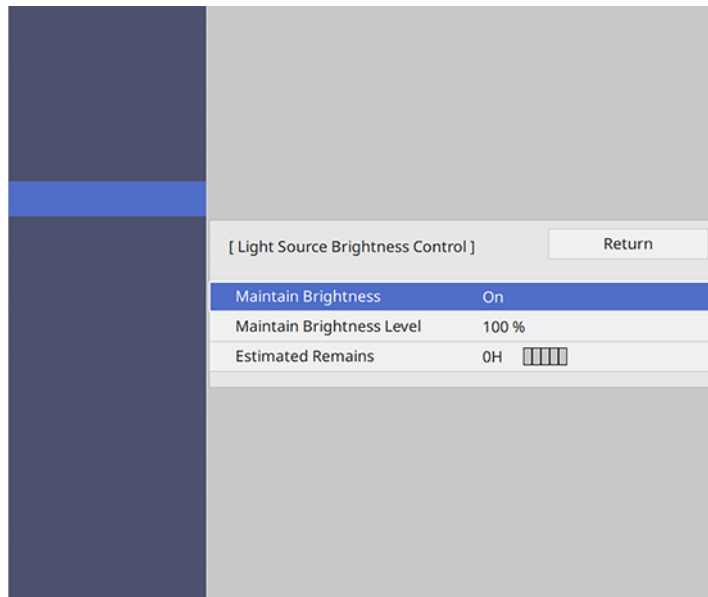

Display level	Estimated remaining hours
[][][][][]	10000 or more hours
[][][][][]	8000 to 9999 hours
[][][][][]	6000 to 7999 hours
[][][][][]	4000 to 5999 hours
[][][][][]	2000 to 3999 hours

Display level	Estimated remaining hours
	0 to 1999 hours

Light source life span

The estimated life span of the light source varies depending on the **Brightness Level** setting and whether the **Maintain Brightness** setting is on or off.

Maintain Brightness off

Brightness Level setting	Hours
100%	20000 hours
90%	21000 hours
80%	24000 hours
70%	30000 hours

Maintain Brightness on

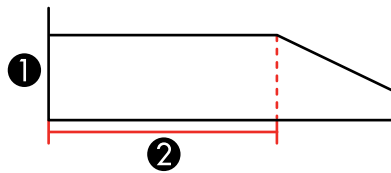

- 1 Brightness level
- 2 Time the projector can maintain constant brightness (approximate)

Brightness Level setting	Hours
85%	6000 hours
80%	10000 hours
70%	19000 hours

Note: The light source usage hours vary depending upon environmental conditions and usage. The hours listed here are an approximate and are not guaranteed. You may need to replace internal parts

sooner than the estimated light source operation time. If **Maintain Brightness** is turned on, and you have exceeded the usage hours listed here, you may not be able to select a high **Maintain Brightness Level** setting.

Parent topic: [Adjusting the Projector's Brightness Level](#)

Turning On Dynamic Contrast

You can turn on the **Dynamic Contrast** setting to automatically optimize the image luminance. This improves the image contrast based on the brightness of the content you project.

1. Turn on the projector and switch to the image source you want to use.
2. Press the **Menu** button.
3. Select the **Image** menu and press **↵ Enter**.

Frequently Used Items	Image	
Image	Color Mode	Presentation
Signal I/O	Brightness	50
Installation	Contrast	50
Display	Color Saturation	50
Operation	Tint	50
Management	Sharpness	50
Network	White Balance	
Pen/Touch	Dynamic Contrast	Off
Interactive	Noise Reduction	0
Multi-Projection	MPEG Noise Reduction	Off
Memory	Gamma	0
ECO	RGBCMY	
Initial/All Settings	Deinterlacing	Off
	Super-resolution	
	Detail Enhancement	
	Reset to Defaults	
	Source	Computer1
	Resolution	Auto

4. Select the **Dynamic Contrast** setting, choose one of the following options, and press **↵ Enter**:
 - **Normal** to adjust brightness at the standard speed.
 - **High Speed** to adjust brightness as soon as the scene changes.

5. Press **Menu** or **Esc** to exit the menu.

Parent topic: [Using Basic Projector Features](#)

Controlling the Volume with the Volume Buttons

You can use the **Volume** buttons on the remote control to adjust the volume of your projected content. The volume buttons control the projector's internal speaker system or any external speakers you connected to the projector.

You must adjust the volume separately for each connected input source.

1. Turn on the projector and start a presentation that includes audio.
2. To lower or raise the volume, press the **Volume** buttons on the remote control.

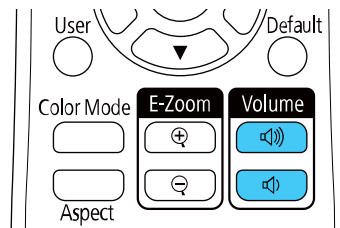

A volume gauge appears on the screen.

3. To set the volume to a specific level for an input source, use the projector menus.

Parent topic: [Using Basic Projector Features](#)

Inverting the Audio Channels

You can invert the audio's left and right channels to match the projector installation position.

1. Turn on the projector and start a presentation.
2. Press the **Menu** button.

3. Select the **Signal I/O** menu and press **↵ Enter**.

Frequently Used Items	Signal I/O	
Image	Volume	
Signal I/O	Source	Computer1
Installation	Signal Format	
Display	Mic Input Level	50
Operation	Overscan	Auto
Management	EDID	3240x1080/60Hz
Network	Reset to Defaults	
Pen/Touch	A/V Output	While Projecting
Interactive	Inverse Audio	Off
Multi-Projection	Audio Output	Auto
Memory	HDMI Audio Output	
ECO	Monitor Out Port	Monitor Out
Initial/All Settings	USB Display	0
	HDMI Link	
	Reset Signal I/O Settings	
	Installation	
	Fixed Installation	Off

4. Set the **Inverse Audio** setting to **On**.
5. Press **Menu** or **Esc** to exit the menus.

Parent topic: [Using Basic Projector Features](#)

Selecting a Quick Startup Setting

If you want to quickly restart the projector within five seconds after turning it off, you can change the **Quick Startup** setting. You can select 20, 60, or 90 minutes of Quick Startup time.

Note: The projector may take longer than five seconds to start up in the following conditions:

- When projecting from the projector's **USB-B1** or **HDMI Out** port
- When projecting with Screen Mirroring
- If whiteboard sharing was terminated in the previous session
- If you want to restore the whiteboard contents from the previous session

Note: The Quick Startup setting is displayed only if the A/V Output setting in the Signal I/O menu is set to **While Projecting**, the Auto Power On setting in the Network menu is set to **Off**, and the Power On Trigger setting in the Operation menu is set to **Plug-in Detection**.

1. Turn on the projector.
2. Press the **Menu** button.
3. Select the **Operation** menu and press **↵ Enter**.

Frequently Used Items	Operation	
Image	Auto Source Search	On
Signal I/O	Light Source Brightness Cont...	
Installation	Direct Power On	Off
Display	Auto Power On	Off
Operation	Sleep Mode	On ^
Management	Sleep Mode Timer	10 min.
Network	A/V Mute Timer	On
Pen/Touch	Standby Mode	Communication On ^
Interactive	Port	Wired LAN
Multi-Projection	Quick Startup	Off
Memory	Indicators	On
ECO	Inv Direction Button	Off
Initial/All Settings	Reset Operation Settings	
	Management	
	User Button	Light Source Mode
	User's Logo	
	User Pattern	

4. Select the **Quick Startup** setting and press **↵ Enter**.
5. Select how long you want to enable Quick Startup mode for and press **↵ Enter**.
6. Press **Menu** or **Esc** to exit the menus.

Press the power button to quickly restart the projector in this mode.

Parent topic: [Using Basic Projector Features](#)

Projecting a PC Free Presentation

You can use your projector's PC Free feature whenever you connect a USB device that contains compatible files. This lets you quickly and easily display the contents of the files and control their display using the projector's remote control.

[Supported PC Free File Types](#)

[Starting a PC Free Slideshow](#)

[Starting a PC Free Movie Presentation](#)

[PC Free Display Options](#)

Parent topic: [Using Basic Projector Features](#)

Supported PC Free File Types

You can project these types of files using the projector's PC Free feature.

Note: For best results, place your files on media that is formatted in FAT16/32. If you have trouble projecting from media formatted for non-Windows file systems, try formatting the media for Windows instead. You may not be able to use the security features on certain USB storage devices with PC Free features. When connecting a USB-compatible hard drive, connect the AC adapter supplied with the drive. PC Free may not work with USB device security features. If you are using a connected card reader, the projector can recognize up to five cards.

File type and extension	Details
Image (.jpg)	Make sure the file is not: <ul style="list-style-type: none">• CMYK format• Progressive format• Highly compressed• Above 8192 × 8192 resolution
Image (.bmp)	Make sure the file resolution is not above 1280 × 800
Image (.gif)	Make sure the file is not: <ul style="list-style-type: none">• Above 1280 × 800 resolution• Animated• Interlaced

File type and extension	Details
Image (.png)	Make sure the file resolution is not: <ul style="list-style-type: none"> • Above 1920 × 1200 • Interlaced
Motion JPEG movie (.avi)	Supports only AVI 1.0 Make sure the file is not: <ul style="list-style-type: none"> • Saved with a video codec other than Motion JPEG • Saved with an audio codec other than LPCM or IMA ADPCM • Above 1280 × 720 resolution • Larger than 2GB • Saved with a frame rate higher than 30 fps • Saved with an audio sampling rate other than 11.025 kHz, 16 kHz, 22.05 kHz, 24 kHz, 32 kHz, or 44.1 kHz
H.264, H.265 (.mp4/.mov)	Make sure the file is not: <ul style="list-style-type: none"> • Larger than 2GB • Above 1920 × 1200 resolution • A color format other than YUV420 • Saved with a movie codec other than H.264/MPEG-4 AVC (Baseline Profile, Main Profile, High Profile) or H.265/MPEG-H HEVC (Main Profile) • Saved with a frame rate higher than 30 fps • Saved with an audio codec other than MPEG-2 AAC-LC, MPEG-4 AAC-LC, or LPCM • Saved with an audio sampling rate other than 11.025 kHz, 16 kHz, 22.05 kHz, 24 kHz, 32 kHz, 44.1 kHz, or 48 kHz for LPCM, or 44.1 kHz or 48 kHz for MPEG-2 AAC-LC and MPEG-4 AAC-LC • Saved with audio other than 8-bit or 16-bit and up to 2 channels • A format other than single slice structure

Parent topic: [Projecting a PC Free Presentation](#)

Starting a PC Free Slideshow

After connecting a USB device or digital camera to the projector, you can switch to the USB input source and start your slideshow.

Note: You can change the slideshow operation options or add special effects by highlighting **Option** at the bottom of the screen and pressing **↵ Enter**.

Note: You can also use the interactive pen or your finger to operate the slideshow.

1. Press the **USB** button on the projector remote control until the PC Free file list appears.
The PC Free screen appears.



2. Do the following as necessary to locate your files:
 - If you need to display files inside a subfolder on your device, press the arrow buttons to highlight the folder and press **↵ Enter**.
 - To move back up a folder level on your device, highlight **Back to Top** and press **↵ Enter**.
 - To view additional files in a folder, highlight **Next page** or **Previous page** and press **↵ Enter**.

- To display images from a different USB drive, select **Select Drive** at the top of the PC Free screen and press **↵ Enter**.
3. Do one of the following:
 - To display an individual image, press the arrow buttons to highlight the image and press **↵ Enter**. (Press the **Esc** button to return to the file list screen.)
 - To display a slide show of all the images in a folder, press the arrow buttons to highlight the **Slideshow** option at the bottom of the screen and press **↵ Enter**.

Note: If any file names are longer than the display area or include unsupported symbols, the file names may be shortened or changed only in the screen display.

4. While projecting, use the following commands to control the display as necessary:
 - To rotate a displayed image, press the up or down arrow button. You can also rotate the image by flicking it with the interactive pen or your finger.
 - To move to the next or previous image, press the left or right arrow button. You can also move between images by flicking the image with the interactive pen or your finger.

Note: You can use the **Freeze**, **A/V Mute**, and **E-Zoom** functions while projecting in PC Free mode.

5. To stop the display, follow the on-screen instructions or press the **Esc** button.
6. Turn off the USB device, if necessary, and then disconnect the device from the projector.

Parent topic: [Projecting a PC Free Presentation](#)

Starting a PC Free Movie Presentation

After connecting a USB device or digital camera to the projector, you can switch to the USB input source and start your movie.

Note: You can change the operation options by highlighting **Option** at the bottom of the screen and pressing **↵ Enter**.

1. Press the **USB** button on the projector remote control until the PC Free screen appears.

The PC Free screen appears.



2. Do the following as necessary to locate your files:
 - If you need to display files inside a subfolder on your device, press the arrow buttons to highlight the folder and press **↵ Enter**.
 - To move back up a folder level on your device, highlight **Back to Top** and press **↵ Enter**.
 - To view additional files in a folder, highlight **Next page** or **Previous page** and press **↵ Enter**.
 - To display movie files from a different USB drive, select **Select Drive** at the top of the PC Free screen and press **↵ Enter**.
3. To play back a movie, press the arrow buttons to highlight the file and press **↵ Enter**.

Note: If any file names are longer than the display area or include unsupported symbols, the file names may be shortened or changed only in the screen display. If you want to play back all the movies in a folder in sequence, select the **Slideshow** option at the bottom of the screen.
4. To stop movie playback, press the **Esc** button, highlight **Exit**, and press **↵ Enter**.
5. Turn off the USB device, if necessary, and then disconnect the device from the projector.

Parent topic: [Projecting a PC Free Presentation](#)

PC Free Display Options

You can select these display options when using the projector's PC Free feature.



Setting	Options	Description
Display Order	Name Order	Displays files in name order
	Date Order	Displays files in date order
Sort Order	In Ascending	Sorts files in first-to-last order
	In Descending	Sorts files in last-to-first order
Continuous Play	On	Displays a slideshow continuously
	Off	Displays a slideshow one time through
Screen Switching Time	No	Does not display the next file automatically
	1 Second to 60 Seconds	Displays files for the selected time and switches to the next file automatically; high resolution images may switch at a slightly slower rate

Setting	Options	Description
Effect	No	No effect
	Wipe	Transitions between images with a wipe effect
	Dissolve	Transitions between images with a dissolve effect
	Random	Transitions between images using a random variety of effects

Parent topic: [Projecting a PC Free Presentation](#)

Adjusting Projector Features

Follow the instructions in these sections to use your projector's feature adjustments.

[Shutting Off the Picture and Sound Temporarily](#)

[Stopping Video Action Temporarily](#)

[Zooming Into and Out of Images](#)

[Using Multiple Projectors \(DuoLink\)](#)

[Projecting Multiple Images Simultaneously](#)

[Projector Security Features](#)

[Creating a User Pattern to Display](#)

[Saving Settings to Memory and Using Saved Settings](#)

[Copying Menu Settings Between Projectors](#)

[Scheduling Projector Events](#)

Shutting Off the Picture and Sound Temporarily

You can temporarily turn off the projected picture and sound if you want to redirect your audience's attention during a presentation. Any sound or video action continues to run, however, so you cannot resume projection at the point that you stopped it.

If you want to display an image such as a company logo or picture when the presentation is stopped, you can set up this feature using the projector's menus.

1. Press the **A/V Mute** button on the remote control to temporarily stop projection and mute any sound.

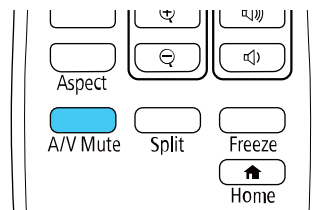

2. To turn the picture and sound back on, press **A/V Mute** again.

Note: The projector's power automatically turns off thirty minutes after A/V Mute is enabled. You can disable this feature in the projector's **Operation** menu.

Note: You can also stop projection by selecting the **A/V Mute** icon in the interactive toolbar.

Parent topic: [Adjusting Projector Features](#)

Related tasks

[Saving a User's Logo Image to Display](#)

Stopping Video Action Temporarily

You can temporarily stop the action in a video or computer presentation and keep the current image on the screen. Any sound or video action continues to run, however, so you cannot resume projection at the point that you stopped it.

Note: You can also stop video action using the interactive pens.

1. Press the **Freeze** button on the remote control to stop the video action.

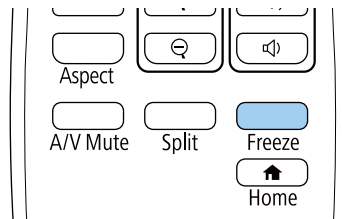

2. To restart the video action in progress, press **Freeze** again.

Parent topic: [Adjusting Projector Features](#)

Zooming Into and Out of Images

You can draw attention to parts of a presentation by zooming into a portion of the image and enlarging it on the screen.

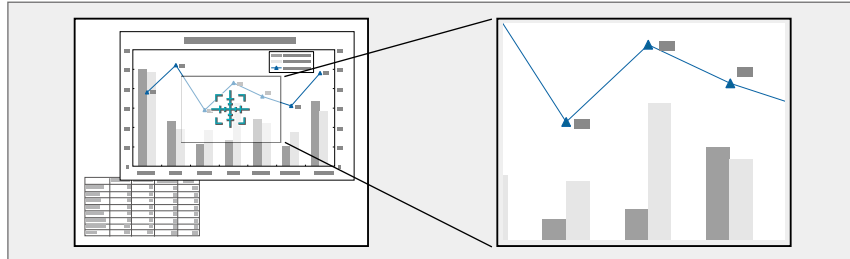

Note: This feature is unavailable if the **Scale** setting in the Image menu is enabled (BrightLink 1485Fi).

1. Press the **E-Zoom +** button on the remote control.

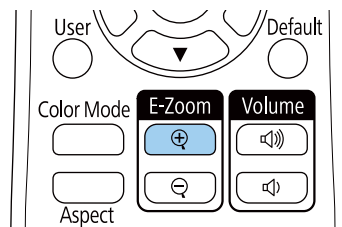

You see a crosshair on the screen indicating the center of the zoom area.

2. Use the following buttons on the remote control to adjust the zoomed image:
 - Use the arrow buttons to position the crosshair in the image area you want to zoom into.
 - Press the **E-Zoom +** button repeatedly to zoom into the image area, enlarging it as necessary. Press and hold the **E-Zoom +** button to zoom in more quickly.
 - To pan around the zoomed image area, use the arrow buttons.
 - To zoom out of the image, press the **E-Zoom –** button as necessary.
 - To return to the original image size, press the **Esc** button.

Parent topic: [Adjusting Projector Features](#)

Using Multiple Projectors (DuoLink)

You can combine the projected images from two or more projectors to create one large image (BrightLink 1485Fi). Follow the instructions in these sections to set up and project from multiple projectors.

Note: Wait at least 30 minutes after you start projecting before adjusting the image.

Note: The interactive features are not available when connecting more than two projectors. See the online *Edge Blending Setup Guide* (available only in English) for additional information.

[Projector Identification System for Multiple Projector Control](#)

[Adjusting Color Uniformity](#)

[Blending the Image Edges](#)

[Matching the Image Colors](#)

[Adjusting the Black Level](#)

[Adjusting RGBCMY](#)

[Scaling an Image](#)

Parent topic: [Adjusting Projector Features](#)

Projector Identification System for Multiple Projector Control

You can operate multiple projectors using one remote control for more elaborate presentations. To do this, you assign an identification number to each projector and to the remote control. Then you can operate all the projectors at once or individually.

[Setting the Projector ID](#)

[Setting the Remote Control ID](#)

Parent topic: [Using Multiple Projectors \(DuoLink\)](#)

Setting the Projector ID

If you want to control multiple projectors from a remote control, give each projector a unique ID.

1. Press the **Menu** button.
2. Select the **Multi-Projection** (BrightLink 1485Fi) or **Installation** (BrightLink 1480Fi) menu and press **↵ Enter**.

3. Select **Projector ID** and press **↵ Enter**.

[Projector ID]	Return
✓ Off	
1	
2	
3	
4	
5	
6	
7	
8	
9	

4. Press the arrow buttons on the remote control to select the identification number you want to use for the projector. Then press **↵ Enter**.

Repeat these steps for all the other projectors you want to operate from one remote control.

Note: If you don't know the projector's ID, aim the remote control at the projector and press the **ID** button to temporarily display the projector's ID on the screen.

Parent topic: [Projector Identification System for Multiple Projector Control](#)

Setting the Remote Control ID

The remote control's ID is set to zero by default so it can operate any compatible projector. If you want to set the remote control to operate only a particular projector, you need to set the remote control's ID to match the projector's ID.

1. Turn on the projector you want the remote control to operate with exclusively.
2. Make sure you know the projector's ID number as set in the Multi-Projection menu **Projector ID** setting.
3. Aim the remote control at that projector.

4. Hold down the **ID** button on the remote control while you press the numeric button that matches the projector's ID. Then release the buttons.

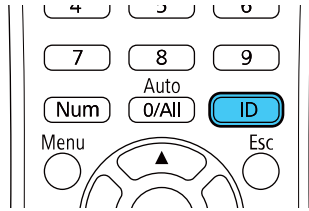

The remote control's ID is set.

Note: If the batteries are left out of the remote control for an extended period, the remote control ID returns to its default setting.

Parent topic: [Projector Identification System for Multiple Projector Control](#)

Adjusting Color Uniformity

If the color tone is uneven on each screen, adjust the color tone balance in the Multi-Projection menu of each projector. (The color tone may not be uniform even after performing color uniformity.)

Note: Set the **Color Mode** setting in each projector's Image menu to **Multi-Projection** before you start projecting (BrightLink 1485Fi).

1. Press the **Menu** button on the remote or control panel, select the **Multi-Projection** menu, and press **↵ Enter**.

Frequently Used Items	Multi-Projection
Image	Projector ID Off
Signal I/O	HDMI Out Setting Off ▼
Installation	Geometry Correction Point Correction
Display	Edge Blending
Operation	Scale
Management	Color Uniformity
Network	Light Source Mode Normal
Pen/Touch	Color Matching
Interactive	RGBCMY
	Reset Multi-Projection Settings
Multi-Projection	Memory
Memory	Save Memory
ECO	Load Memory
Initial/All Settings	Rename Memory
	Erase Memory
	Reset Memory
	ECO

2. Select the **Color Uniformity** setting and press **↵ Enter**.

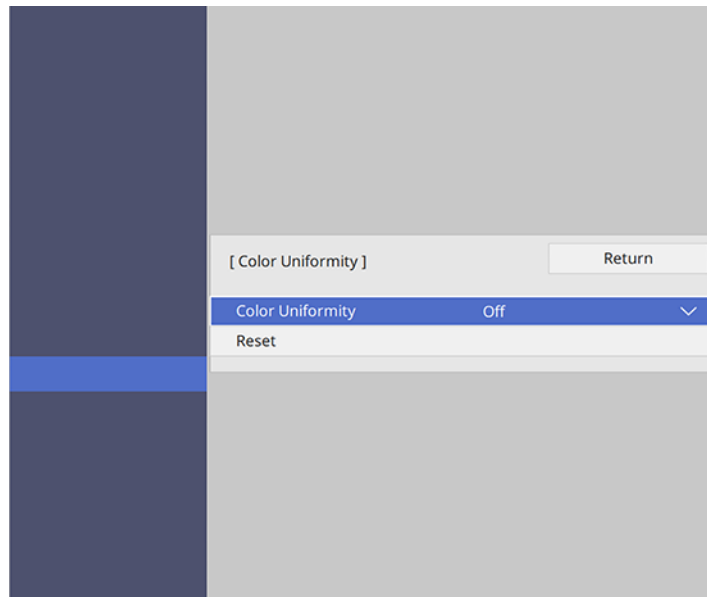

3. Select **On** as the **Color Uniformity** setting and press **↵ Enter**, then press **Esc**.
4. Select **Adjustment Level** and press **↵ Enter**.
5. Select an adjustment level and press **Esc**.
6. Select **Start Adjustments** and press **↵ Enter**.

7. Select the area you want to adjust and press **↵ Enter**.

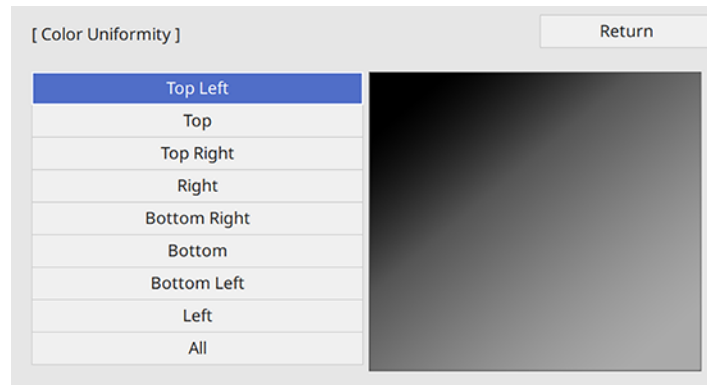

8. Select **Red**, **Green**, or **Blue** and press the left arrow button to weaken the color tone or the right arrow button to strengthen the color tone.

Note: The adjustment screen changes each time you press **↵ Enter**.

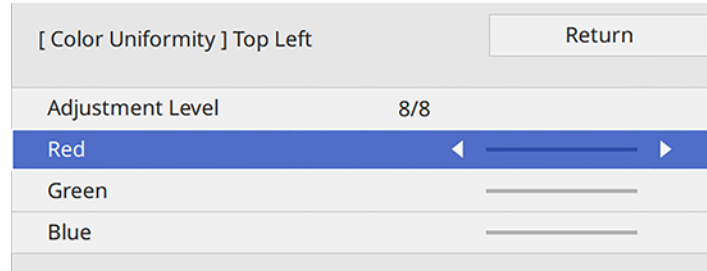

9. Press **Esc** to return to the area selection screen.
10. Repeat steps 7 through 9 for each area, then select **All** to adjust the entire screen.
11. Press **Esc** to exit the menus.

Parent topic: [Using Multiple Projectors \(DuoLink\)](#)

Related references

[Image Quality Settings - Image Menu](#)

Blending the Image Edges

You can use the projector's Edge Blending feature to create a seamless image from multiple projectors (BrightLink 1485Fi).

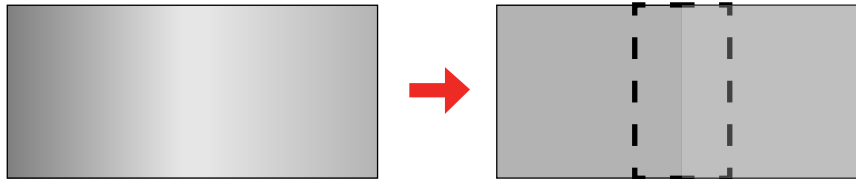

1. Press the **Menu** button.
2. Select the **Multi-Projection** menu and press **↵ Enter**.

Frequently Used Items	Multi-Projection
Image	Projector ID Off
Signal I/O	HDMI Out Setting Off
Installation	Geometry Correction Point Correction
Display	Edge Blending
Operation	Scale
Management	Color Uniformity
Network	Light Source Mode Normal
Pen/Touch	Color Matching
Interactive	RGBCMY
	Reset Multi-Projection Settings
Multi-Projection	Memory
Memory	Save Memory
ECO	Load Memory
Initial/All Settings	Rename Memory
	Erase Memory
	Reset Memory
	ECO

3. Select the **Edge Blending** setting and press **↵ Enter**.

4. Turn on the **Edge Blending**, **Line Guide**, and **Pattern Guide** settings.

Note: Select a different **Guide Color** setting for each projector so that you can see the blended area clearly.

5. Select the edge you want to blend on each projector and press **↵ Enter**. For the projector on the left, select the **Right Edge** and for the projector on the right, select **Left Edge**.

You see a screen like this:

[Top Edge]		Return
Blending	Off	
Blend Start Position	0	_____
Blend Range	0	_____
Blend Curve	0	

6. Select the **Blending** setting and select **On**.
7. Press **Esc** to return to the previous screen.
8. Select the **Blend Start Position** setting and adjust the point where edge blending begins.

Note: If you created a 3:1 unified image area using the Edge Blending feature, set the Blend Start Position setting to **600** (BrightLink 1485Fi).

9. Select the **Blend Range** setting and use the arrow buttons to select the width of the blended area so that the displayed guides are at the edges of the overlapping area between the two images.

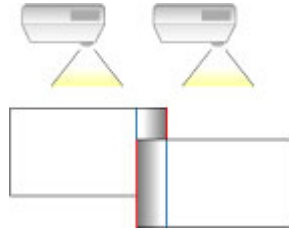

Note: If you created a unified image area using the Edge Blending feature, set the **Blend Range** setting to **600**. Depending on your installation environment, you can also set the **Blend Range** setting to **600** or less but black bands may appear on the side of the projected screen.

10. Press **Esc** to go back to the previous screen.
11. Select the **Blend Curve** setting and select a gradient for the shaded area on the projectors.
12. When the edges are blended, turn off the **Line Guide** and **Pattern Guide** settings on each projector to check the final settings.
13. When you are finished, press the **Menu** button.

If the blended area does not overlap exactly, correct the shape of the blended area using **Point Correction**.

Parent topic: [Using Multiple Projectors \(DuoLink\)](#)

Matching the Image Colors

You can match the display color of multiple projectors that will project next to one another (BrightLink 1485Fi). Turn on all the projectors so you can properly adjust the color of the combined screen.

1. Press the **Menu** button.

2. Select the **Multi-Projection** menu (BrightLink 1485Fi) and press **↵ Enter**.

Frequently Used Items	Multi-Projection
Image	Projector ID Off
Signal I/O	HDMI Out Setting Off
Installation	Geometry Correction Point Correction
Display	Edge Blending
Operation	Scale
Management	Color Uniformity
Network	Light Source Mode Normal
Pen/Touch	Color Matching
Interactive	RGBCMY
	Reset Multi-Projection Settings
Multi-Projection	Memory
Memory	Save Memory
ECO	Load Memory
Initial/All Settings	Rename Memory
	Erase Memory
	Reset Memory
	ECO

3. Select the **Color Matching** setting and press **↵ Enter**.

You see this screen:

[Color Matching]	Return		
Adjustment Level	1	◀	▶
Red	0	▬	
Green	0	▬	
Blue	0	▬	
Brightness		-	+

4. Press the left or right arrow button to select **Adjustment Level 8**.

Note: There are several adjustment levels and you can adjust each level individually.

5. Press the left or right arrow buttons to adjust the **Brightness** setting.
6. Press the left or right arrow buttons to adjust the color tone for the **Red**, **Green**, and **Blue** settings if necessary.
7. Press **Esc** to return to the Multi-Projection menu.
8. Select the **Operation** menu and press **↵ Enter**.
9. Select **Light Source Brightness Control** and press **↵ Enter**.
10. Set the **Light Source Mode** setting to **Custom** and adjust the **Brightness Level** setting as necessary.
11. Press **Esc** and repeat steps 2 through 6 for **Adjustment Level 7** through **2**.
12. When you are finished, press the **Menu** button.

Parent topic: [Using Multiple Projectors \(DuoLink\)](#)

Adjusting the Black Level

When two images overlap, the overlapping area can appear differently from the areas that do not overlap. You can use the projector's Black Level setting to make the difference less noticeable (BrightLink 1485Fi).

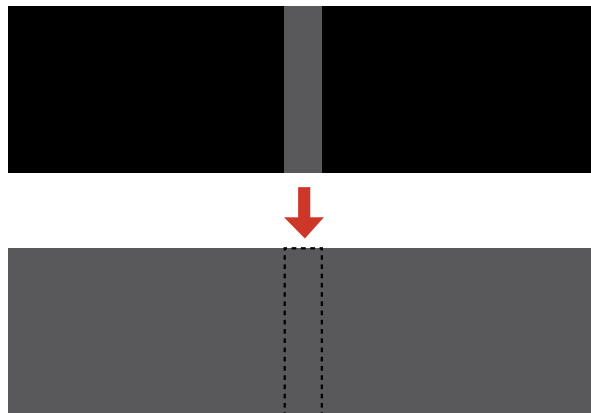

Note: You cannot adjust the black levels while projecting a test pattern, and you may not be able to adjust the black levels correctly if the **Geometry Correction** settings are set too high. The brightness and tone of the overlapping areas may differ from the rest of the image even after adjusting the black level.

1. Press the **Menu** button.
2. Select the **Multi-Projection** menu and press **↵ Enter**.

Frequently Used Items	Multi-Projection
Image	Projector ID Off
Signal I/O	HDMI Out Setting Off ▼
Installation	Geometry Correction Point Correction
Display	Edge Blending
Operation	Scale
Management	Color Uniformity
Network	Light Source Mode Normal
Pen/Touch	Color Matching
Interactive	RGBCMY
	Reset Multi-Projection Settings
Multi-Projection	Memory
Memory	Save Memory
ECO	Load Memory
Initial/All Settings	Rename Memory
	Erase Memory
	Reset Memory
	ECO

3. Select the **Black Level** setting and press **↵ Enter**.

Note: The **Black Level** setting is displayed only if **Edge Blending** is enabled and at least one (top, bottom, left, right) edge is set to **On**.

4. Select the **Color Adjustment** setting and press **↵ Enter**.

You see a screen based on the **Top Edge**, **Bottom Edge**, **Right Edge**, and **Left Edge** settings you selected for the **Edge Blending** setting.

5. Select the area you want to adjust and press **↵ Enter**.

Note: The area you selected is displayed in orange. Adjust overlapping areas starting with the brightest areas first. For example, adjust area 2 to match area 1, then adjust area 3 to match area 2.

6. Adjust the brightness and tone of the areas that do not overlap to match the areas that overlap using the displayed adjustment sliders. Then press the **Esc** button.

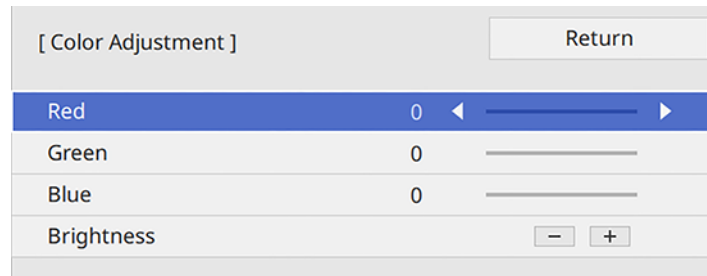

7. Repeat the previous two steps as needed until all areas match.
8. If the tone of some areas do not match, you can adjust them using the **Area Correction** setting. Continue with the next step. Otherwise, press the **Menu** button to exit.
9. Press the **Esc** button to return to the Black Level screen.
10. Select the **Area Correction** setting and press **↵ Enter**.
11. Select the **Start Adjustments** setting and press **↵ Enter**.

You see a screen with boundary lines indicating areas that are overlapping. The boundary lines are based on the **Top Edge**, **Bottom Edge**, **Right Edge**, and **Left Edge** settings you selected for the **Edge Blending** setting.

12. Use the arrow buttons to select a boundary line of the area you want to adjust and press **↵ Enter**.

The selected line is displayed in orange.



13. Use the arrow buttons to adjust the boundary line position and press **↵ Enter**.

14. Use the arrow buttons to select an adjustment point and press **↵ Enter**.

Note: You can change the number of adjustment points displayed by changing the **Points** setting in the Area Correction menu.

The selected point turns orange.

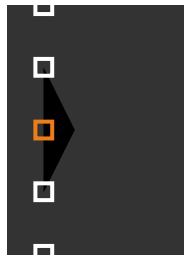

15. Use the arrow buttons to move the point.

16. To move another point, press the **Esc** button and repeat the previous two steps.

17. To move another boundary line, press the **Esc** button repeatedly until you can select a boundary line.

18. When you are finished, press the **Esc** button until you see a confirmation message. Select **Yes** and press **↵ Enter**.

19. When you are finished, press the **Menu** button.

Note: Changing the **Top Edge**, **Bottom Edge**, **Right Edge**, or **Left Edge** settings resets the **Black Level** setting to its default value.

Parent topic: [Using Multiple Projectors \(DuoLink\)](#)

Adjusting RGBCMY

You can adjust the **Hue**, **Saturation**, and **Brightness** settings for R (red), G (green), B (blue), C (cyan), M (magenta), and Y (yellow) color components.

Turn on all the projectors and select the **RGBCMY** setting in each projector's Image menu so that the color tone on the combined screen becomes entirely even.

1. Press the **Menu** button.
2. Select the **Image** menu and press **↵ Enter**.

Frequently Used Items	Image	
Image	Color Mode	Presentation
Signal I/O	Brightness	50
Installation	Contrast	50
Display	Color Saturation	50
Operation	Tint	50
Management	Sharpness	50
	White Balance	
Network	Dynamic Contrast	Off
Pen/Touch	Noise Reduction	0
Interactive	MPEG Noise Reduction	Off
Multi-Projection	Gamma	0
Memory	RGBCMY	
ECO	Deinterlacing	Off
Initial/All Settings	Super-resolution	
	Detail Enhancement	
	Reset to Defaults	
	Source	Computer1
	Resolution	Auto

3. Select the **RGBCMY** setting and press **↵ Enter**.

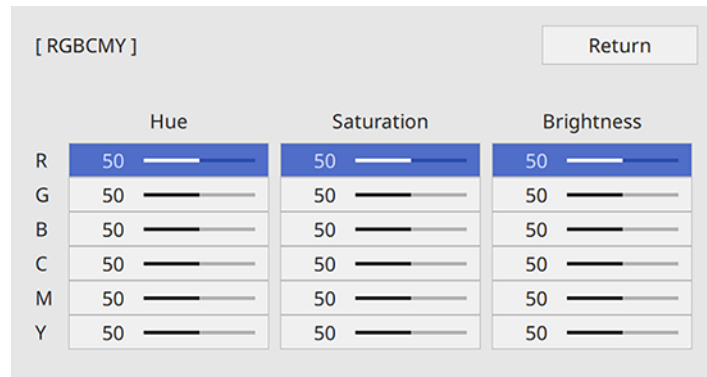

4. Select the color you want to adjust and press **↵ Enter**.
You see this screen:

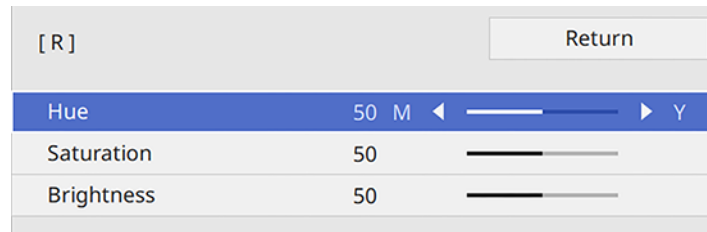

- To adjust the overall hue of the color, adjust the **Hue** setting.
 - To adjust the overall vividness of the color, adjust the **Saturation** setting.
 - To adjust the overall brightness of the color, adjust the **Brightness** setting.
5. Press the left or right arrow buttons to adjust the **Hue**, **Saturation**, and **Brightness** settings.
 6. Repeat the previous two steps as necessary to adjust each color.
 7. Press **Menu** or **Esc** to exit the menus.

Parent topic: [Using Multiple Projectors \(DuoLink\)](#)

Scaling an Image

You can project the same image from multiple projectors and use the Scale feature to crop and combine them into one large image (BrightLink 1485Fi).

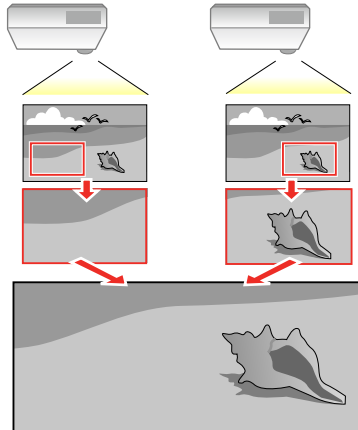

1. Press the **Menu** button.
2. Select the **Multi-Projection** menu and press **↵ Enter**.
3. Select the **Scale** setting and press **↵ Enter**.

You see this screen:

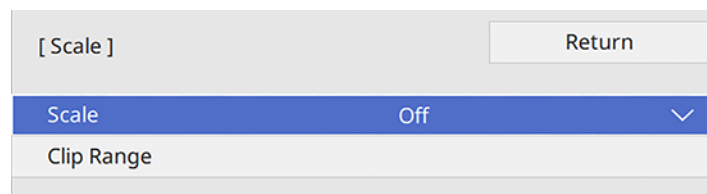

4. Select one of the following as the **Scale** setting:
 - **Auto** to automatically adjust the clipped areas according to the **HDMI Out Setting** and **Edge Blending** settings you selected
 - **Manual** to adjust the clipped areas manually

5. Select the **Scale Mode** setting and select one of these options:

- **Zoom Display** to maintain the image aspect ratio as you scale the image



- **Full Display** to adjust the image to the projector's screen size as you scale the image

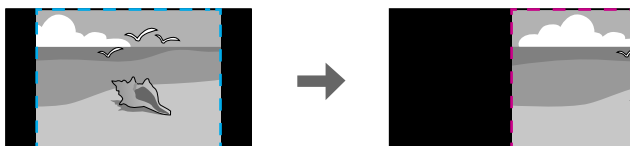
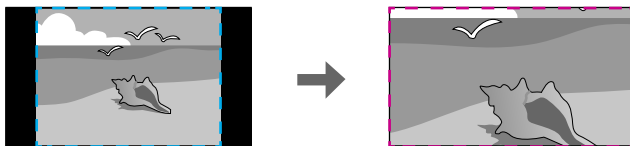

6. If you selected **Auto** as the Scale setting, you can skip the remaining steps. If you selected **Manual**, adjust each of the following options as necessary:

- Select **-** or **+** to scale the image horizontally and vertically at the same time
- Select **Scale Vertically** to scale the image vertically only
- Select **Scale Horizontally** to scale the image horizontally only

7. Select the **Clip Adjustment** setting and use the arrow buttons to adjust the coordinates and size of each image as you view the screen.

8. Select the **Clip Range** setting to preview the area you just selected.
9. Press the **Menu** button to exit.

Parent topic: [Using Multiple Projectors \(DuoLink\)](#)

Projecting Multiple Images Simultaneously

You can use the split screen feature to simultaneously project from two or four images from different image sources next to each other. You can control the split screen feature using the remote control, the projector menus, or the interactive function.

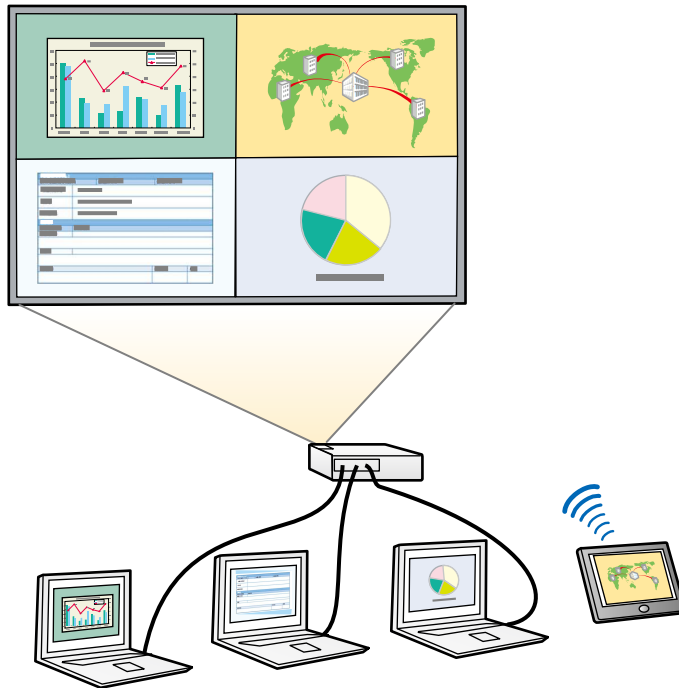

Note: While you use the split screen feature, other projector features may not be available and some settings may be automatically applied to all images.

Note: You cannot use split screen with certain input source combinations. You cannot perform split screen projection when the **Connect ELPCB02** setting is set to **On** in the Installation menu. You may not be able to perform split screen projection when you use the **Scale** or **Edge Blending** options.

Note: If you are projecting content from one source, you can split the projected image with a whiteboard screen. Click the link below for more information.

1. Press the **Split** button on the remote control.

Note: You can also select **Split Screen** from the Home screen.

You are prompted for the number of screens.

2. Select **2 Screens** or **4 Screens**, depending on the number of input sources you want to project.

If you selected **2 Screens**, the currently selected input source moves to the left side of the screen. If you selected **4 Screens** and used the split screen feature to project four images before, the projected images are arranged in the same order as they were previously.

3. Press the **Menu** button.

You see a screen like this:

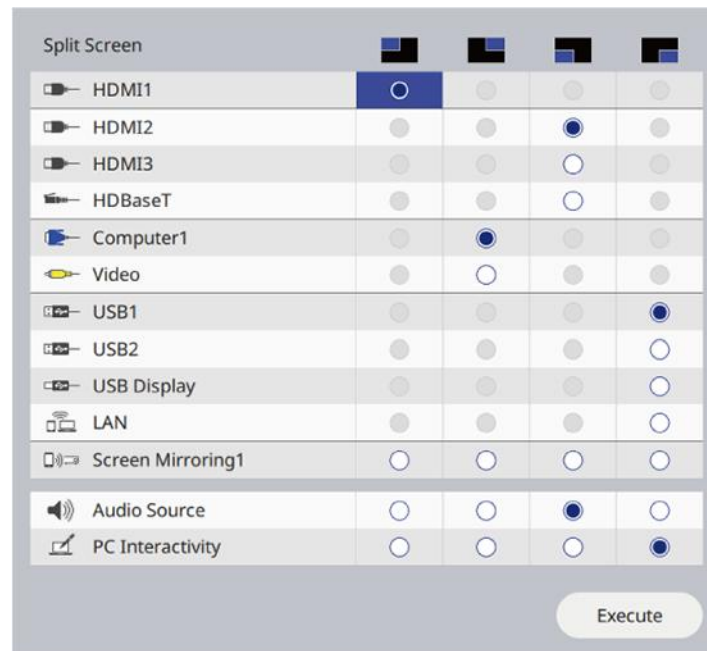

4. Press the arrow and **Enter** buttons to select an image source for each section of the screen.

5. To choose the audio you want to hear, select an input source as the **Audio Source** setting.
6. To select the input source to be controlled by finger or pen interactivity, select an input source as the **PC Interactivity** setting.

Note: A Touch Unit is optional for the BrightLink 1480Fi and must be installed to enable finger touch operation.

Note: A Touch Unit is optional and must be installed to enable finger touch operation. When **USB Display** is not selected as one of the input sources, you cannot select the **PC Interactivity** source.

7. If you selected **2 Screens** and want to change the size of the images, select a sizing option as the **Screen Size** setting.
8. Select **Execute** and press **↵ Enter**.
9. To exit the split screen feature, press the **Split** or **Esc** button.

[Input Sources for Split Screen Projection](#)

[Split Screen Projection Restrictions](#)

Parent topic: [Adjusting Projector Features](#)

Related tasks

[Splitting the Projected Image with Whiteboard Mode](#)

Input Sources for Split Screen Projection

You can choose most input source combinations for split screen projection, but the following combinations are not supported:

- **HDMI2, HDMI3, HDBaseT**
- **Computer1, Computer2, Video**
- **USB1, USB2, USB Display, LAN**
- **HDMI2, HDMI3** (BrightLink 1480Fi)

Note: The **HDBaseT** source is available only for the BrightLink 1485Fi. When you split the screen into quarters and select the **USB1** or **USB** input source, you can select only **Screen Mirroring1** or **Screen Mirroring2** for the other input sources.

Parent topic: [Projecting Multiple Images Simultaneously](#)

Split Screen Projection Restrictions

You cannot perform the following operations during split screen projection:

- Change settings in the projector's menu
- E-Zoom
- Switching the aspect mode (the aspect mode is set to **Auto**)
- Operations using the **User** button on the remote control, other than displaying the network information on the projected surface
- Applying the **Dynamic Contrast** setting
- Displaying the network information on the projected surface by a method other than pressing the **User** button
- Displaying the Screen Mirroring information bar

Image restrictions

- Even if you set **No-signal screen** to **Logo** in the Display menu, the blue screen appears when no image signal is being input
- When you create a single, unified image projected from multiple projectors and use the split screen feature, the second projector detects no image signal

Parent topic: [Projecting Multiple Images Simultaneously](#)

Projector Security Features

You can secure your projector to deter theft or prevent unintended use by setting up the following security features:

- Password security to prevent the projector from being turned on, and prevent changes to the startup screen and other settings.
- Button lock security to block operation of the projector using the buttons on the control panel.
- Security cabling to physically cable the projector in place.

[Password Security Types](#)

[Locking the Projector's Buttons](#)

[Installing a Security Cable](#)

Parent topic: [Adjusting Projector Features](#)

Password Security Types

You can set up these types of password security using one shared password:

- **Power On Protection** password prevents anyone from using the projector without first entering a password.
- **User's Logo** password prevents anyone from changing the custom screen the projector can display when it turns on. The presence of the custom screen discourages theft by identifying the projector's owner.
- **Network** password prevents anyone from changing the network settings in the projector menus.
- **Schedule** password prevents anyone from changing the projector's time or schedule settings.
- **Interactive** password prevents anyone from changing the projector's interactive settings.

[Setting a Password](#)

[Selecting Password Security Types](#)

[Entering a Password to Use the Projector](#)

[Saving a User's Logo Image to Display](#)

Parent topic: [Projector Security Features](#)

Setting a Password

To use password security, you must set a password.

Note: The default password is set to **0000**.

1. Hold down the **Freeze** button on the remote control for about 5 seconds or until you see this menu.

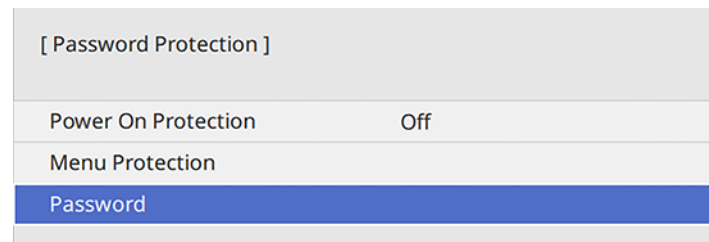

2. Press the down arrow to select **Password** and press **↵ Enter**.
You see the prompt "Change the password?".

3. Select **Yes** and press **↵ Enter**.
4. Press and hold down the **Num** button on the remote control and use the numeric buttons to set a four-digit password.

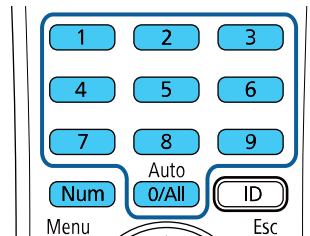

The password displays as **** as you enter it. Then you see the confirmation prompt.

5. Enter the password again.
You see the message "Password accepted."
6. Press **Esc** to return to the menu.
7. Make a note of the password and keep it in a safe place in case you forget it.

Parent topic: [Password Security Types](#)

Selecting Password Security Types

After setting a password, you see this menu, allowing you to select the password security types you want to use.

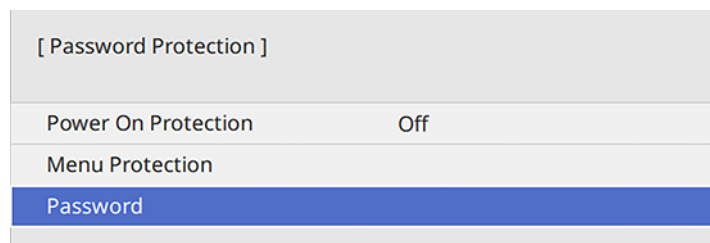

If you do not see this menu, hold down the **Freeze** button on the remote control for about five seconds or until the menu appears.

- To prevent unauthorized use of the projector, select **Power On Protection**, press **↵ Enter**, select **On**, press **↵ Enter** again, and press **Esc**.

- To prevent changes to certain projector settings, select **Menu Protection**, press **↵ Enter**, and do the following as necessary:
 - To prevent changes to the User's Logo screen or related display settings, select **User's Logo**, press **↵ Enter**, select **On**, press **↵ Enter** again, and press **Esc**.
 - To prevent changes to the projector's time or schedule settings, select **Schedule**, press **↵ Enter**, select **On**, press **↵ Enter** again, and press **Esc**.
 - To prevent changes to network settings, select **Network**, press **↵ Enter**, select **On**, press **↵ Enter** again, and press **Esc**.
 - To prevent changes to the projector's interactive settings, select **Interactive**, press **↵ Enter**, select **On**, press **↵ Enter** again, and press **Esc**.

You can attach the Password Protect sticker to the projector as an additional theft deterrent.

Note: Be sure to keep the remote control in a safe place; if you lose it, you will not be able to enter the password required to use the projector.

Parent topic: [Password Security Types](#)

Entering a Password to Use the Projector

If a password is set up and a **Power On Protection** password is enabled, you see a prompt to enter a password whenever you turn on the projector.

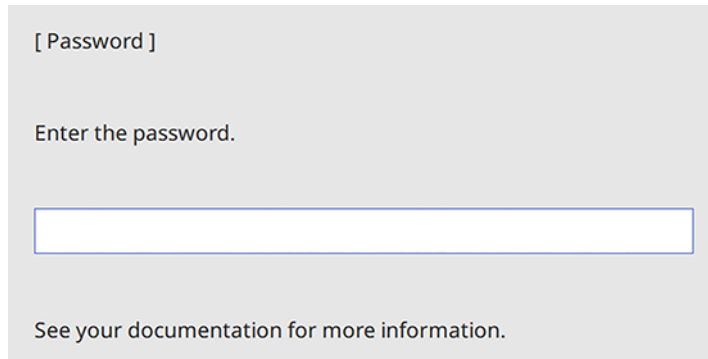

[Password]

Enter the password.

You must enter the correct password to use the projector.

1. Press and hold down the **Num** button on the remote control while you enter the password using the numeric buttons.

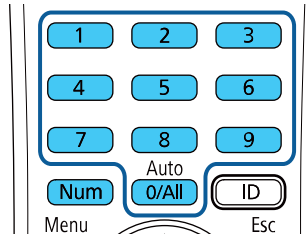

Note: The default password is **0000**.

The password screen closes.

2. If the password is incorrect, the following may happen:
 - You see a "wrong password" message and a prompt to try again. Enter the correct password to proceed.
 - If you have forgotten the password, make note of the **Request Code: xxxxx** number that appears on the screen and contact Epson Support.
 - If you enter an incorrect password three times in succession, you see a message telling you that the projector is locked. After the message is displayed for 5 minutes, the projector enters standby mode. Unplug the projector, plug in the power cord, and turn on the projector. You see a prompt to enter the password.
 - If you continue to enter an incorrect password many times in succession, the projector displays a request code and a message to contact Epson Support. Do not attempt to enter the password again. When you contact Epson Support, provide the displayed request code and proof of ownership for assistance in unlocking the projector.

Parent topic: [Password Security Types](#)

Related references

[Where to Get Help \(U.S. and Canada\)](#)

Saving a User's Logo Image to Display

You can transfer an image to the projector and then display it whenever the projector turns on. You can also display the image when the projector is not receiving an input signal or when you temporarily stop projection. This transferred image is called the User's Logo screen.

The image you select as the User's Logo can be a photo, graphic, or company logo, which is useful in identifying the projector's owner to help deter theft. You can prevent changes to the User's Logo by setting up password protection for it.

Note: You cannot save an image that is protected by HDCP as a User's Logo.

Note: When you copy the menu settings from one projector to another using the batch setup feature, the user logo is also copied. Do not include any information in the user logo that you do not want to share between multiple projectors.

1. Display the image you want to project as the User's Logo.
2. Press the **Menu** button, select the **Management** menu, and press **↵ Enter**.

Frequently Used Items	Management
Image	User Button Light Source Mode
Signal I/O	User's Logo
Installation	User Pattern
Display	Control Panel Lock Off
Operation	Color Uniformity
Management	Refresh Mode
Network	Light Source Calibration
Pen/Touch	Date & Time
Interactive	Schedule Settings
Multi-Projection	Wireless LAN Power
Memory	Wireless LAN Diagnosis 1
ECO	Log Save Destination USB and Internal Memory
Initial/All Settings	Batch Setup Range
	Language English
	Information
	Display Logs
	Reset Management Settings
	Network

3. Select the **User's Logo** setting and press **↵ Enter**.
4. Select **Start Setting** and press **↵ Enter**.
You see a prompt asking if you want to use the displayed image as a user's logo.

Note: When you select **User's Logo**, adjustments such as **Geometry Correction**, **E-Zoom**, **Aspect**, **Scale** (BrightLink 1485Fi), and **Screen Type** are temporarily canceled.

5. Select **Yes** and press **↵ Enter**.

Note: Depending on the image signal, the screen size may change to match the resolution of the image signal.

6. Make sure the image appears as you want it, then select **Yes** again and press **↵ Enter**.

You see a completion message.

7. Press **Esc** to exit the message screen.
8. Select the **Display** menu and press **↵ Enter**.
9. Select when you want to display the User's Logo screen:

- To display it whenever there is no input signal, select **No-Signal Screen** and set it to **Logo**.
- To display it whenever you turn the projector on, select **Startup Screen** and set it to **On**.

To prevent anyone from changing the User's Logo settings without first entering a password, set a password and enable User's Logo security.

Parent topic: [Password Security Types](#)

Related tasks

[Selecting Password Security Types](#)

[Setting a Password](#)

Locking the Projector's Buttons

You can lock the buttons on the projector's control panel to prevent anyone from using the projector. You can lock all the buttons or all the buttons except the power button.

1. Press the **Menu** button.

2. Select the **Management** menu and press **↵ Enter**.

Frequently Used Items	Management
Image	User Button Light Source Mode
Signal I/O	User's Logo
Installation	User Pattern
Display	Control Panel Lock Off
Operation	Color Uniformity
Management	Refresh Mode
Network	Light Source Calibration
Pen/Touch	Date & Time
Interactive	Schedule Settings
Multi-Projection	Wireless LAN Power
Memory	Wireless LAN Diagnosis 1
ECO	Log Save Destination USB and Internal Memory
Initial/All Settings	Batch Setup Range
	Language English
	Information
	Display Logs
	Reset Management Settings
	Network

3. Select the **Control Panel Lock** setting and press **↵ Enter**.
4. Select one of these lock types and press **↵ Enter**:
 - To lock all of the projector's buttons, select **Full Lock**.
 - To lock all buttons except the power button, select **Except for Power**.You see a confirmation prompt.
5. Select **Yes** and press **↵ Enter**.

[Unlocking the Projector's Buttons](#)

Parent topic: [Projector Security Features](#)

Unlocking the Projector's Buttons

If the projector's buttons have been locked, hold the **↵ Enter** button on the projector's control panel for 7 seconds to unlock them. You can also set the **Control Panel Lock** setting to **Off** in the Management menu.

Parent topic: [Locking the Projector's Buttons](#)

Related references

[Administration Settings - Management Menu](#)

Installing a Security Cable

You can install two types of security cables on the projector to deter theft.

- Use the security slot on the projector to attach a Kensington lock. See your local computer or electronics dealer for purchase information.
- Use the security cable attachment point on the projector to attach a wire cable and secure it to a room fixture or heavy furniture.

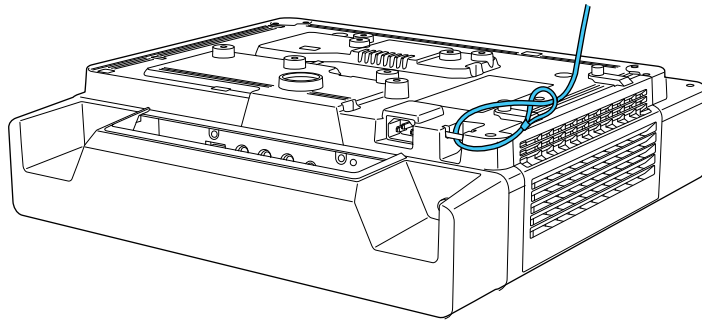

Parent topic: [Projector Security Features](#)

Creating a User Pattern to Display

You can transfer an image to the projector and then display it as a pattern to aid in presentations when you use the Pattern Display feature. This transferred image is called the User Pattern.

Note: Once you save a user pattern, you cannot restore the default pattern. You cannot save an image that is protected by HDCP. If a pattern is displayed for a long time, a residual image may be visible in projected images.

1. Display the image you want to project as the User Pattern from a connected computer or video source.

2. Press the **Menu** button, select the **Management** menu, and press **↵ Enter**.

Frequently Used Items	Management
Image	User Button Light Source Mode
Signal I/O	User's Logo
Installation	User Pattern
Display	Control Panel Lock Off
Operation	Color Uniformity
Management	Refresh Mode
Network	Light Source Calibration
Pen/Touch	Date & Time
Interactive	Schedule Settings
Multi-Projection	Wireless LAN Power
Memory	Wireless LAN Diagnosis 1
ECO	Log Save Destination USB and Internal Memory
Initial/All Settings	Batch Setup Range
	Language English
	Information
	Display Logs
	Reset Management Settings
	Network

3. Select the **User Pattern** setting and press **↵ Enter**.

You see a prompt asking if you want to use the displayed image as a User Pattern.

Note: When you select **User Pattern**, adjustments such as **Keystone**, **E-Zoom**, **Aspect**, **Adjust Zoom**, or **Image Shift** are temporarily canceled.

4. Select **Yes** and press **↵ Enter**.

Note: It takes a few moments for the projector to save the image; do not use the projector, its remote control, or any connected equipment until it is finished.

You see a completion message.

5. Press **Esc** to exit the message screen.

To view your user pattern, press the **Menu** button, select the **Display** menu, and press **↵ Enter**. Set the **Pattern Type** setting to **User Pattern**, then return to the Display menu and select **Pattern Display**.

Parent topic: [Adjusting Projector Features](#)

Saving Settings to Memory and Using Saved Settings

You can save customized settings for each of your video inputs and then select the saved settings whenever you want to use them.

1. Turn on the projector and display an image.
2. Press the **Menu** button.
3. Select the **Memory** menu and press **Enter**.

You see this screen:

Frequently Used Items	Scale
Image	Color Uniformity
Signal I/O	Light Source Mode Normal
Installation	Color Matching
Display	RGBCMY
Operation	Reset Multi-Projection Settings
Management	Memory
Network	Save Memory
Pen/Touch	Load Memory
Interactive	Rename Memory
Multi-Projection	Erase Memory
Memory	Reset Memory
ECO	ECO
Initial/All Settings	Light Source Mode Normal
	Sleep Mode On
	Standby Mode Communication On
	Initial/All Settings
	Reset All

4. Select one of the following options:
 - **Load Memory:** Overwrites your current settings with saved settings
 - **Save Memory:** Saves your current settings to memory (10 memories with different names are available)

Note: A memory name that has already been used is indicated by a blue mark. Saving over a previously saved memory overwrites the settings with your current settings.

- **Erase Memory:** Erases the selected memory settings
- **Rename Memory:** Renames a saved memory
- **Reset Memory Settings:** Delete all saved memory

5. Press **Esc** to exit.

Parent topic: [Adjusting Projector Features](#)

Copying Menu Settings Between Projectors

After you select menu settings for your projector, you can transfer them to another projector of the same model.

Note: Copy the projector's settings before you adjust the projected image using the projector's Geometry Correction settings. Any saved User's Logo setting on the projector will transfer to the other projector.

Caution: If the copy process fails due to a power failure, communication error, or for any other reason, Epson will not be responsible for any repair costs incurred.

The following settings will not transfer between projectors:

- Light Source Hours
- Status

The following settings will not transfer between projectors if you set the **Batch Setup Range** setting to **Limited**:

- Password Protection settings
- **EDID** in the Signal I/O menu
- Network menu settings

Note: In addition to the methods covered in this section, you can also copy and transfer settings to multiple projectors over a network using the Epson Projector Management software. See the online *Epson Projector Management Operation Guide* for instructions. You can download the latest software and documentation from the Epson website.

[Saving Settings to a USB Flash Drive](#)

[Transferring Settings from a USB Flash Drive](#)

[Saving Settings to a Computer](#)

[Transferring Settings from a Computer](#)

Parent topic: [Adjusting Projector Features](#)

Saving Settings to a USB Flash Drive

You can save the projector settings you want to transfer to a USB flash drive.

Note: Use an empty flash drive. If the drive contains other files, the transfer may not complete correctly. The flash drive must use the FAT format and cannot have any security features.

1. Turn off the projector and unplug the power cord from the projector's power inlet.
2. Insert the flash drive into the **USB-A1** or **USB-A2** port.

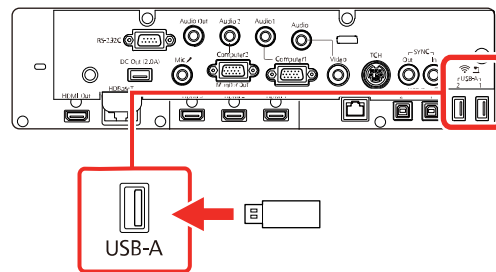

Note: Connect the flash drive directly to the projector. Do not use a hub or your settings may not be saved correctly.

3. Press and hold the **Esc** button on the control panel or remote control as you connect the power cord to the projector's power inlet.
4. When the power and Status lights are blue, and the Laser and Temp lights are orange, release the **Esc** button.

The lights flash to indicate that settings are transferring to the flash drive. When the lights stop flashing, the power light turns blue and the projector enters standby mode.

Caution: Do not unplug the power cord or remove the flash drive while the lights are flashing. This could damage the projector.

5. Once the projector enters standby mode, remove the flash drive.

Note: If the projector does not enter standby mode and the lights continue flashing, see the link below for a solution.

Parent topic: [Copying Menu Settings Between Projectors](#)

Related references

[Projector Light Status](#)

Transferring Settings from a USB Flash Drive

After saving projector settings to a USB flash drive, you can transfer them to another projector of the same model.

Note: Make sure the USB flash drive contains only a single settings transfer from another projector of the same model. The settings are contained in a file called **pjconfdata.bin**. If the drive contains other files, the transfer may not complete correctly.

Do not adjust image settings on a projector until after you transfer settings to it. Otherwise, you may have to repeat your adjustments.

1. Turn off the projector and unplug the power cord from the projector's power inlet.
2. Insert the flash drive into one of the USB-A ports.

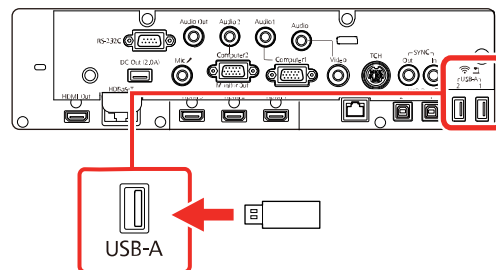

Note: Connect the flash drive directly to the projector. Do not use a hub or your settings may not be saved correctly.

3. Press and hold the **Menu** button on the control panel or remote control as you connect the power cord to the projector's power inlet.
4. When the power and Status lights are blue, and the Laser and Temp lights are orange, release the **Menu** button.

The lights flash to indicate that settings are transferring to the projector. When the lights stop flashing, the power light turns blue and the projector enters standby mode.

Caution: Do not unplug the power cord or remove the flash drive while the lights are flashing. This could damage the projector.

5. Once the projector enters standby mode, remove the flash drive.

Note: If the projector does not enter standby mode and the lights continue flashing, see the link below for a solution.

Parent topic: [Copying Menu Settings Between Projectors](#)

Related references

[Projector Light Status](#)

Saving Settings to a Computer

You can save the projector settings you want to transfer to a computer.

Your computer must be running one of the following operating systems:

- Windows 7
- Windows 8.x
- Windows 10
- OS X 10.11.x
- macOS 10.12.x
- macOS 10.13.x
- macOS 10.14.x
- macOS 10.15.x

1. Turn off the projector and unplug the power cord from the projector's power inlet.

2. Connect a USB cable to your projector's **USB-B1** port.

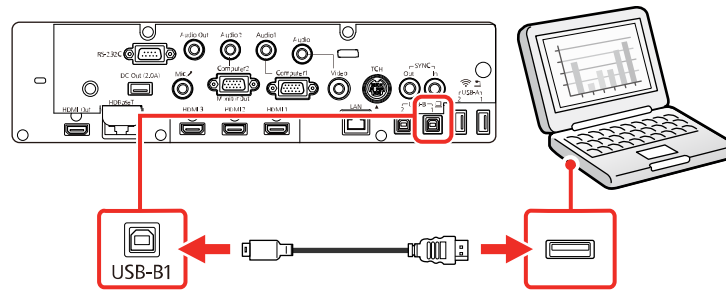

3. Connect the other end to any available USB port on your computer.
4. Press and hold the **Esc** button on the control panel or remote control as you connect the power cord to the projector's power inlet.
5. When the power and Status lights are blue, and the Laser and Temp lights are orange, release the **Esc** button.

The projector shows up as a removable disk on your computer.

6. Open the removable disk and copy the **pjconfdata.bin** file to your computer.
7. Once the file has copied, do one of the following:
 - **Windows:** Open the **My Computer**, **Computer**, **Windows Explorer**, or **File Explorer** utility. Right-click the name of your projector (listed as a removable disk) and select **Eject**.
 - **Mac:** Drag the removable disk icon for your projector from the desktop into the trash.

The projector turns off when you disconnect the USB cable.

Note: If the projector does not turn off and the lights continue flashing, see the link below for a solution.

Parent topic: [Copying Menu Settings Between Projectors](#)

Related references

[Projector Light Status](#)

Transferring Settings from a Computer

After saving projector settings to a computer, you can transfer them to another projector of the same model.

Your computer must be running one of the following operating systems:

- Windows 7
- Windows 8.x
- Windows 10
- OS X 10.11.x
- macOS 10.12.x
- macOS 10.13.x
- macOS 10.14.x
- macOS 10.15.x

Do not adjust image settings on a projector until after you transfer settings to it. Otherwise, you may have to repeat your adjustments.

1. Turn off the projector and unplug the power cord from the projector's power inlet.
2. Connect a USB cable to your projector's **USB-B1** port.

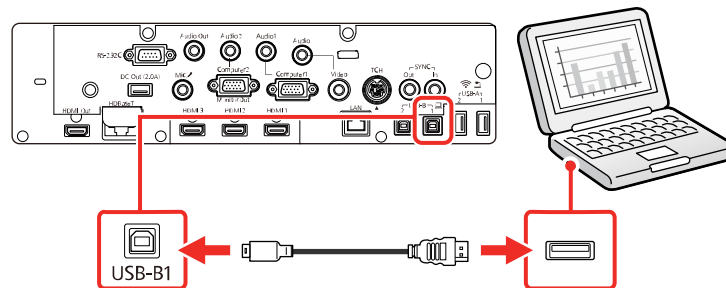

3. Connect the other end to any available USB port on your computer.
4. Press and hold the **Menu** button on the control panel or remote control as you connect the power cord to the projector's power inlet.
5. When the power and Status lights are blue, and the Laser and Temp lights are orange, release the **Menu** button.

The projector shows up as a removable disk on your computer.

6. Copy the **pjconfdata.bin** file from your computer to the removable disk.

Note: Do not copy any other files to the removable disk.

7. Once the file has copied, do one of the following:
 - **Windows:** Open the **My Computer**, **Computer**, **Windows Explorer**, or **File Explorer** utility. Right-click the name of your projector (listed as a removable disk) and select **Eject**.
 - **Mac:** Drag the removable disk icon for your projector from the desktop into the trash.

Various projector lights start flashing to indicate that the projector's settings are being updated. When the lights stop flashing, remove the USB cable from the projector. The projector enters standby mode.

Caution: Do not unplug the power cord while the lights are flashing. This could damage the projector.

Note: If the projector does not turn off and the lights continue flashing, see the link below for a solution.

Parent topic: [Copying Menu Settings Between Projectors](#)

Related references

[Projector Light Status](#)

Scheduling Projector Events

You can save a projector command, such as turning the projector on or off or switching input sources, as an "event." You can schedule when you want the projector to automatically execute the command.

Caution: Do not place flammable objects in front of the lens. If you schedule the projector to turn on automatically, flammable objects in front of the lens could catch on fire.

Note: The **Schedule** setting in the Menu Protection menu must be turned off to schedule an event.

[Saving a Scheduled Event](#)

[Viewing Scheduled Events](#)

[Editing a Scheduled Event](#)

Parent topic: [Adjusting Projector Features](#)

Related tasks

[Selecting Password Security Types](#)

[Setting a Password](#)

Saving a Scheduled Event

You can select projector commands you want to perform and schedule them as an event.

Note: Light Source Calibration events do not start if the projector is not used continuously for at least 20 minutes, or if the projector is regularly turned off by shutting off the power outlet. Set Light Source Calibration events to occur only after 100 hours of usage.

Note: The **Schedule** setting in the Menu Protection menu must be turned off to schedule an event.

1. Set the date and time in the **Management** menu.
2. Press the **Menu** button.
3. Select the **Management** menu and press **↵ Enter**.
4. Select the **Schedule Settings** setting and press **↵ Enter**.
5. Select the **Schedule** menu and press **↵ Enter**.
6. Select **Add New** and press **↵ Enter**.

You see a screen like this:

The screenshot displays a web interface for 'Schedule Settings'. On the left is a dark blue sidebar with menu items: 'Schedule', 'Schedule Reset', and 'Setup complete'. The main content area has a light gray header with 'Schedule Settings' and a 'Return' button. Below the header is a blue bar with '+ Add New'. The main area contains a calendar grid for week 7, with days 7-1 through 7-7 and times 04:00 through 20:00. The 7-1 cell is highlighted in blue.

	7-1	7-2	7-3	7-4	7-5	7-6	7-7
04:00							
08:00							
12:00							
16:00							
20:00							

7. In the Event Settings section, select the events you want to have occur. (Select **No Change** for events that you do not want to occur.)

The screenshot shows the 'Event Settings' screen. On the left is a blue sidebar with 'Schedule', 'Schedule Reset', and 'Setup complete'. The main area is titled 'Event Settings' and contains a table of settings:

Power	No Change
Source	No Change
Light Source Mode	No Change
A/V Mute	No Change
Volume	No Change
Light Source Calibration	No Change
Refresh Mode	No Change

Below this is the 'Date / Time Settings' section:

Type: Date Day of the Week

Date: 2019-07-01

Day of the Week:

Time: 00:00

Buttons: Save, Cancel

8. In the Date/Time Settings section, set the date and time for the scheduled events to occur.
9. When you are finished, select **Save** and press **↵ Enter**.
10. To schedule more events, repeat the previous steps as necessary.
11. Select **Setup complete** and press **↵ Enter** to save your changes.

Parent topic: [Scheduling Projector Events](#)

Viewing Scheduled Events



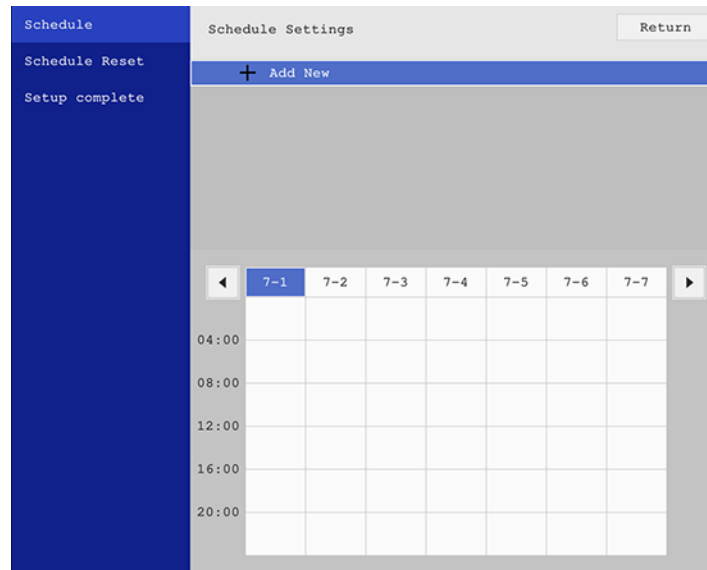

You can view your scheduled events on the calendar displayed on the Schedule Settings screen.

1. Press the **Menu** button.
2. Select the **Management** menu and press **↵ Enter**.
3. Select **Schedule Settings** and press **↵ Enter**.
4. Select **Schedule** and press **↵ Enter**.

You see a screen like this:



Colored boxes on the calendar indicate the following:

-  One-time event
-  Repeating event
-  Communication is on or off
-  Event is invalid

5. To view an event, press the left and right arrow buttons on the remote to select a day. The screen displays the details of the events scheduled for that day. A blue icon indicates an enabled event, a gray icon indicates a disabled event, and the  icon indicates a repeating event.

Parent topic: [Scheduling Projector Events](#)

Editing a Scheduled Event

You can edit any currently scheduled event.

1. Press the **Menu** button.

2. Select the **Management** menu and press **↵ Enter**.
3. Select the **Schedule Settings** setting and press **↵ Enter**.

You see a screen like this:

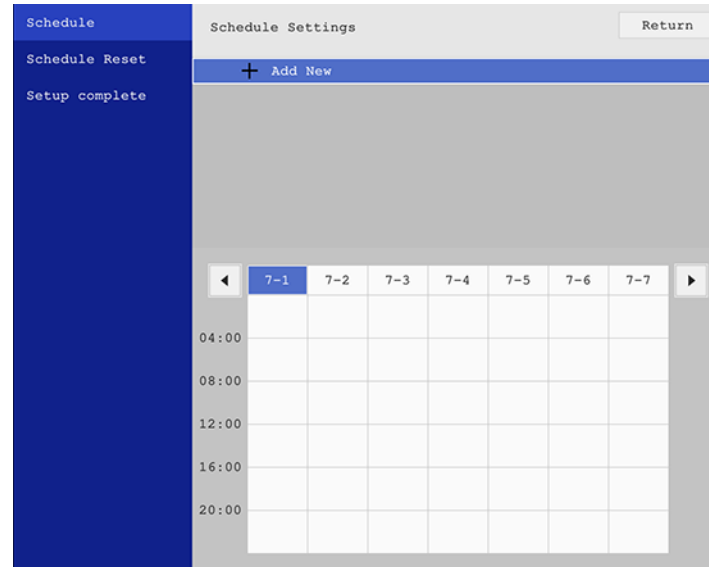

4. Press the left or right arrow buttons to highlight the date on the calendar containing the scheduled event you want to edit.
5. Press the up or down arrow buttons to highlight the event you want to edit, and press **↵ Enter**.
6. Select one of the following:
 - **Enabled/Disabled** to enable or disable the selected event.
 - **Edit** to edit the settings for the selected event.
 - **Clear** to delete the selected event.
 - **Add New** to add a new scheduled event.
7. When you are finished, select **Return** and press **↵ Enter**.
8. Select **Setup complete** and press **↵ Enter** to save your changes.

Note: To delete all scheduled events, select **Schedule Reset** and select **Yes**.

Parent topic: [Scheduling Projector Events](#)

Using the Interactive Features

Follow the instructions in these sections to use your projector's interactive features.

[Interactive Modes](#)

[Using the Interactive Pens](#)

[Using Finger Touch Interactivity](#)

[Using BrightLink with a Computer](#)

[Windows Pen Input and Ink Tools](#)

[Whiteboard Mode](#)

[Using BrightLink Without a Computer](#)

[Splitting the Projected Image with Whiteboard Mode](#)

[Sharing the Projected Screen](#)

[Using Interactive Features with Two Projectors \(DuoLink\)](#)

Interactive Modes

The BrightLink interactive features turn any flat wall into an interactive whiteboard, either with or without a computer. These interactive modes are available:

- In Whiteboard mode, you can use one or both interactive pens and up to 6 fingers to write on the projected "whiteboard". You can split the screen and interact with the whiteboard and another projected source. You can insert images from a USB drive or scanner and save, print, or email your whiteboard pages without connecting a computer.
- In built-in Annotation mode (PC Free Annotation), you can annotate over content projected from a computer, tablet, document camera, or other source. You can capture your annotated pages, and save or print them. You can even split the screen and annotate on up to four images at the same time, using one or both pens or your finger.
- In PC Interactive mode, you can use the interactive pen or your finger as a mouse to navigate, select, and scroll through content from your computer. You can split the screen into four and interact with the computer on one screen and annotate an image on the other three screens.

Note: A Touch Unit is optional for the BrightLink 1480Fi and must be installed for finger touch operation.

Note: You can also use the Easy Interactive Tools software to provide additional interactive features, such as saving your annotations and printing them. See the online *Easy Interactive Tools Operation Guide* for detailed instructions.

[Using the Projected Screen as a Whiteboard \(Built-in Whiteboard Mode\)](#)

[Drawing on a Projected Image \(Built-in Annotation Mode\)](#)

[Controlling Computer Features from a Projected Screen \(PC Interactive Mode\)](#)

Parent topic: [Using the Interactive Features](#)

Using the Projected Screen as a Whiteboard (Built-in Whiteboard Mode)

You can use the interactive pens or your finger to write or draw on the projection surface just as you would on a chalkboard or dry erase board. You can use one pen, both pens at the same time, or a combination of pens and finger touch.

Note: A Touch Unit is optional for the BrightLink 1480Fi and must be installed for finger touch operation.

1. Press the **Home** button on the remote control and select **Whiteboard**.

You see the whiteboard screen, with the toolbar on the bottom of the screen:

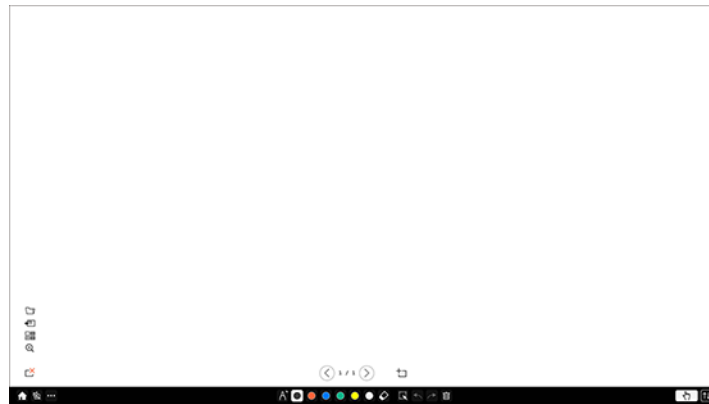

2. To move the toolbar to the right, left, top, or bottom of the screen, use the pen or your finger to drag it to the desired location.
3. To show or hide the toolbar, select the **Hide/Show** icon.

Note: You can also show or hide the projector control toolbar by setting the **Interactive > Display Toolbars** setting to **Always Show** or **Hide for Set Time**.

Parent topic: [Interactive Modes](#)

Related references

[Interactive Settings - Interactive Menu](#)

Drawing on a Projected Image (Built-in Annotation Mode)



You can project from a computer, tablet, video device, or other source and annotate over your projected content using the interactive pens or your finger. You can use one pen, both pens at the same time, or a combination of pens and finger touch.

Note: A Touch Unit is optional for the BrightLink 1480Fi and must be installed for finger touch operation.

1. Project an image from a connected device.

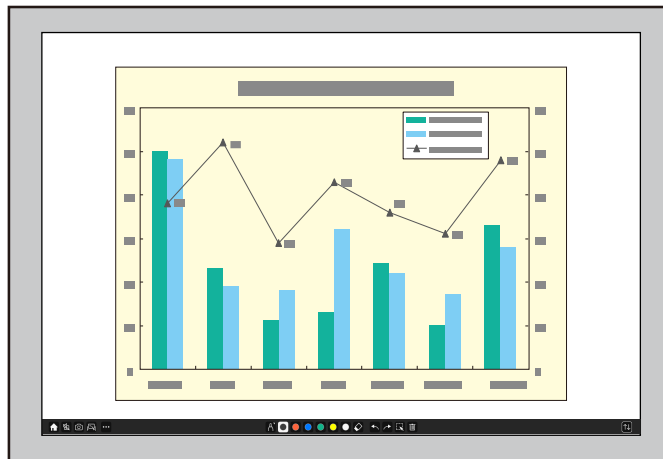
You see the toolbar on the bottom of the projected image.



2. To move the toolbar to the right, left, top, or bottom of the screen, use the pen or your finger to drag it to the desired location.
3. To switch to one of the other interactive modes, do one of the following:
 - To split the screen with whiteboard mode, select the  **Whiteboard** icon on the toolbar.
 - To switch to PC Interactive mode, switch to the input source for the connected computer or select the  **PC Interactivity** icon on the toolbar and make sure it is set to **On** if the computer is already connected.

4. To show or hide the toolbar, select the  icon.

Note: You can also show or hide the projector control toolbar by setting the **Interactive > Display Toolbars** setting to **Always Show** or **Hide for Set Time**.

Parent topic: [Interactive Modes](#)

Related references

[Interactive Settings - Interactive Menu](#)

Controlling Computer Features from a Projected Screen (PC Interactive Mode)

You can navigate, select, and interact with your computer programs from the projected screen using the interactive pens or your finger just as you would a mouse.

Note: A Touch Unit is optional for the BrightLink 1480Fi and must be installed for finger touch operation. Mac users need to install the Easy Interactive Driver before using PC Interactive mode. Go to epson.com/support (U.S.) or epson.ca/support (Canada) and select your projector.

1. Connect your computer to any available video input port on the projector other than a USB port.
2. Connect your computer to the projector's **USB-B1** port.

Note: When using the control pad (BrightLink 1485Fi), you need to connect your computer to the control pad with an HDMI cable and a USB cable plugged in to the control pad's **USB-B** port. If you are connecting over a network, you do not need a USB cable.

3. Turn on your projector and computer to project your computer screen.

4. Press the **Menu** button on the remote control, select the **Pen/Touch** menu, and press the **↵ Enter** button.

Frequently Used Items	Pen/Touch
Image	Auto Calibration
Signal I/O	Manual Calibration
Installation	Touch Unit
Display	Installation of Projectors
Operation	Pen Hovering On
Management	PC Interactivity
Network	Reset Pen/Touch Settings
Pen/Touch	Interactive
Interactive	Drawing Function On
Multi-Projection	Display Toolbars Always Show
Memory	Display Drawing Area
ECO	Confirm Clear Screen On
Initial/All Settings	Pen Button Function Eraser
	Display Clock Date & Time ^
	Date YYYY-MM-DD
	Time HH:MM
	Print

5. Select the **PC Interactivity** setting and press the **↵ Enter** button.
6. Select one of the following as the **Pen Tracking Mode** depending on the operating system your computer is using:
 - **Pen Mode:** Windows or Mac
 - **Mouse Mode:** Ubuntu
7. Press the **↵ Enter** button and press the **Menu** button to exit the projector's menus.
8. Hover near or tap on the board or the projected image with the interactive pen or your finger.
9. Make sure that PC Interactivity is enabled on the toolbar.

Note: You can use PC Interactive mode when connected over a network or with a USB cable (connecting via USB is recommended). When connected via USB, enable the **USB Display** setting in the projector's **Signal I/O** menu and connect the computer to the projector's **USB-B1** port or the **USB-B** port on the control pad (BrightLink 1485Fi). When projecting using USB Display, response time may be slower.

You can now operate the computer using the interactive pens or your finger.

[PC Interactive Mode System Requirements](#)

Parent topic: [Interactive Modes](#)

PC Interactive Mode System Requirements

Your computer system must meet the system requirements here to use PC Interactive mode and Easy Interactive Tools.

Note: Easy Interactive Driver must be installed and running to use Easy Interactive Tools on a Mac.

Requirement	Windows	Mac
Operating system	Windows 7 SP1 Ultimate, Enterprise, Professional, and Home Premium (32- and 64-bit)	OS X 10.11.x; macOS 10.12.x, macOS 10.13.x, macOS 10.14.x, macOS 10.15.x, macOS 11.x (64-bit)
	Windows 8.1, Pro and Enterprise (32- and 64-bit)	
	Windows 10 Home and Pro (32- and 64bit)	
CPU	Intel Core2 Duo 1.2 GHz or faster (Intel Core i3 or faster recommended)	Intel Core2 Duo 1.2 GHz or faster (Intel Core i5 or faster recommended)
Memory	1GB or more (2GB or more recommended)	2GB or more (4GB or more recommended)
Hard disk space	100MB or more	
Display	Resolution between 1024 × 768 and 1920 × 1200, 16-bit color or greater	

Parent topic: [Controlling Computer Features from a Projected Screen \(PC Interactive Mode\)](#)

Using the Interactive Pens

Follow the instructions in these sections to use the interactive pens.

[Using the Pens](#)

[Pen Calibration](#)

Parent topic: [Using the Interactive Features](#)

Using the Pens

Your projector came with a blue pen and an orange pen, identified by the color strip at the end of the pen. You can use either pen, or both pens at the same time (one of each color) in built-in whiteboard or annotation mode.

Make sure the pen batteries are installed.

Note: The pen turns off automatically after 15 seconds of inactivity. Hold the pen to turn the pen back on.

Note: If you are using two pens at the same time, make sure to use them at least 4 inches (10.16 cm) apart to avoid interference.

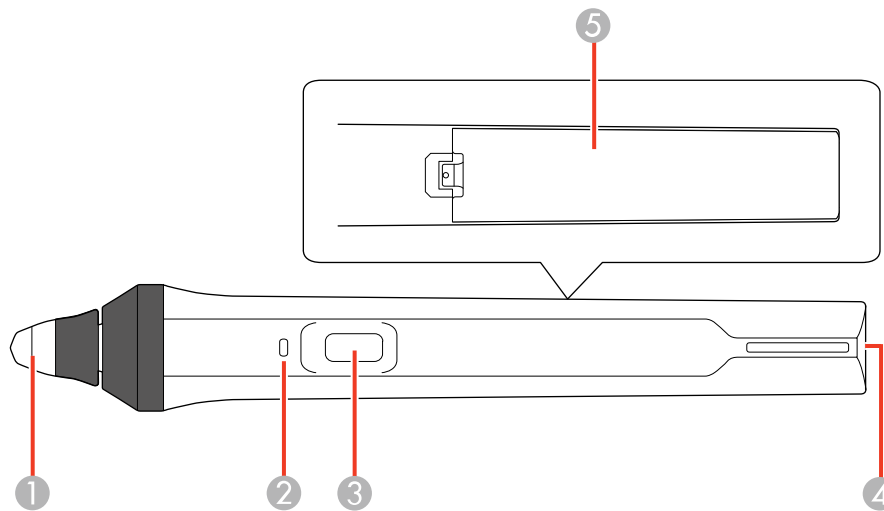

- 1 Pen tip
- 2 Battery light
- 3 Function button
- 4 Attachment for optional strap or cord
- 5 Battery cover

- To turn on the pen, move the pen.

Note: To check the battery, press and hold the function button. If the battery is low, the light flashes. If the light does not turn on or flash, replace the battery.

- For best performance, hold the pen perpendicular to the board, as shown below. Do not cover the black section near the tip of the pen.

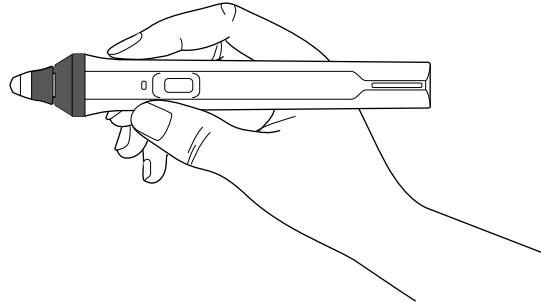

- To write or draw on the projection surface in built-in Annotation mode or built-in Whiteboard mode, do the following:

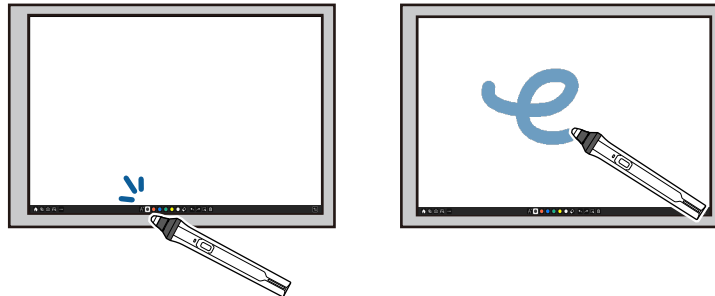

- To select a projected item, such as an icon, tap the projection surface with the pen tip.
- To draw on the projected screen, tap the projection surface with the pen and drag it as necessary.
- To move the pointer, hover over the surface without touching it.
- To switch the pen from drawing tool to eraser or a different function, press the button on the side.

Note: You can change the function of the button by changing the **Pen Button Function** setting in the **Interactive** menu.

- To use the pen as a mouse in PC Interactive mode, do the following:



- To left-click, tap the board with the pen tip.
- To double-click, tap twice.
- To right-click, press the button on the side or press and hold the pen on the screen.

Note: To make a long press of the pen act as a right-click on a Mac or PC, set the **Pen Tracking Mode** setting to **Mouse Mode** and set the **Press and Hold** setting to **Right Click**.

- To click and drag, tap and drag with the pen.
- To move the cursor, hover over the board without touching it.

Note: You can turn off the hovering feature using the **Pen Hovering** setting in the projector's **Pen/Touch** menu.

Parent topic: [Using the Interactive Pens](#)

Related references

[Pen and Touch Setup Settings - Pen/Touch Menu](#)

[Interactive Settings - Interactive Menu](#)

Pen Calibration

Calibration coordinates the position of the pen with the location of your cursor. You only need to calibrate the first time you use your projector's interactive features. Calibration results remain until you calibrate again.

Be sure to calibrate the pen before performing finger touch calibration.

If you notice positioning discrepancies after doing any of the following, calibrate again:

- Performing Geometry Correction
- Adjusting the image size
- Using the Image Shift feature
- Moving the projector

Note: When two projectors are connected and projecting interactive content (BrightLink 1485Fi), draw a line across the two screens after pen calibration and make sure the screens are aligned correctly. If the line position does not match, realign the screens and perform calibration again.

Note: Move any pen you are not using away from the projection screen while calibrating.

[Calibrating Automatically](#)

[Calibrating Manually](#)

Parent topic: [Using the Interactive Pens](#)

Calibrating Automatically

You do not need the pens or a computer for Auto Calibration.

Note: You can start Auto Calibration by pressing the **User** button on the remote control or by pressing the **Menu** button on the remote control as described here.

1. Press the **Menu** button, select the **Pen/Touch** menu, and press **↵ Enter**.

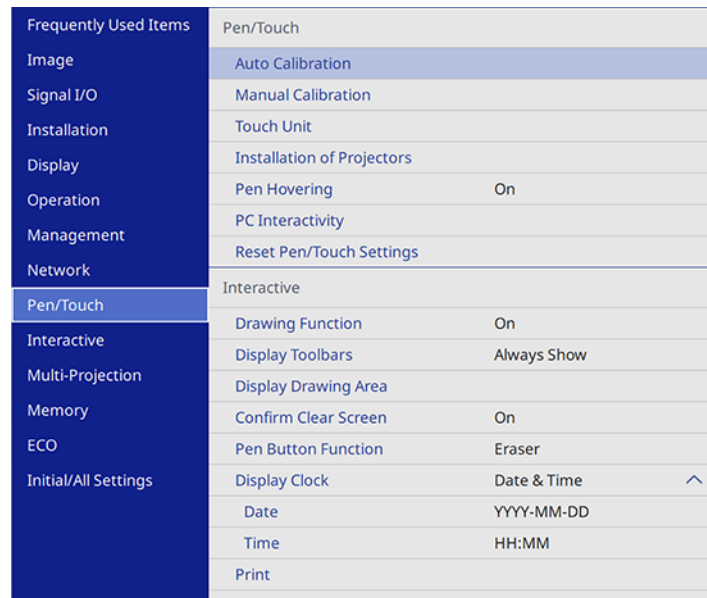

2. Select **Auto Calibration** and press **↵ Enter**.

This screen appears:

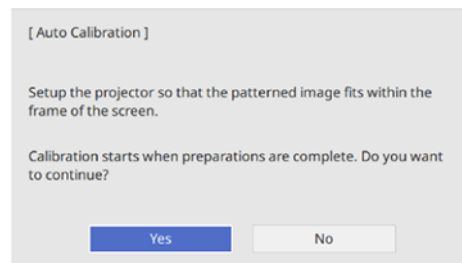

3. Adjust the image focus, if necessary.
4. Check that the image pattern fits into the projected display, then press **↵ Enter** to select **Yes**.

A pattern appears then disappears, and the system is calibrated. If you see a message that calibration failed, you need to calibrate manually.

The cursor location and pen position should match after calibration. If not, you may need to calibrate manually.

Parent topic: [Pen Calibration](#)

Related tasks

[Calibrating Manually](#)

Calibrating Manually

If the cursor location and pen position do not match after auto calibration, you can calibrate manually.

1. Press the **Menu** button, select the **Pen/Touch** menu, and press **↵ Enter**.

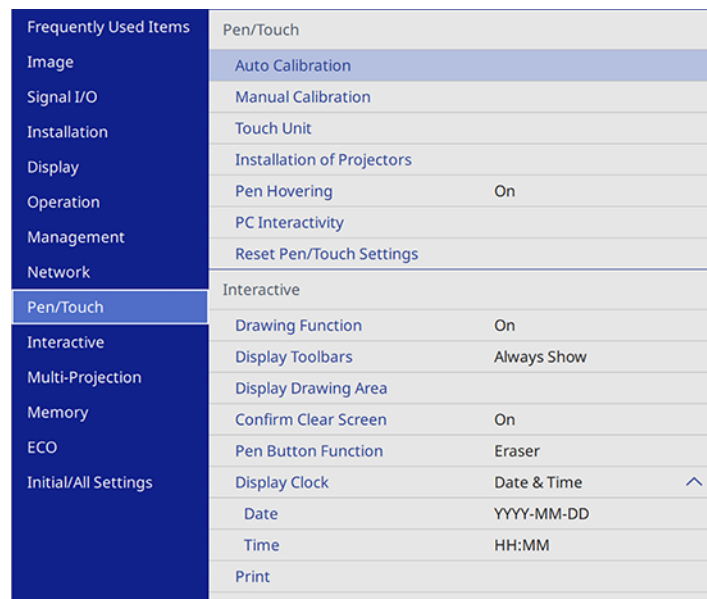

The screenshot shows a system menu with a dark blue sidebar on the left and a light gray main area on the right. The sidebar contains the following categories: Frequently Used Items, Image, Signal I/O, Installation, Display, Operation, Management, Network, Pen/Touch (highlighted), Interactive, Multi-Projection, Memory, ECO, and Initial/All Settings. The main area shows the Pen/Touch menu with the following items: Pen/Touch, Auto Calibration (highlighted), Manual Calibration, Touch Unit, Installation of Projectors, Pen Hovering (On), PC Interactivity, Reset Pen/Touch Settings, Interactive, Drawing Function (On), Display Toolbars (Always Show), Display Drawing Area, Confirm Clear Screen (On), Pen Button Function (Eraser), Display Clock (Date & Time), Date (YYYY-MM-DD), Time (HH:MM), and Print.

Frequently Used Items	Pen/Touch
Image	Auto Calibration
Signal I/O	Manual Calibration
Installation	Touch Unit
Display	Installation of Projectors
Operation	Pen Hovering On
Management	PC Interactivity
Network	Reset Pen/Touch Settings
Pen/Touch	Interactive
Interactive	Drawing Function On
Multi-Projection	Display Toolbars Always Show
Memory	Display Drawing Area
ECO	Confirm Clear Screen On
Initial/All Settings	Pen Button Function Eraser
	Display Clock Date & Time
	Date YYYY-MM-DD
	Time HH:MM
	Print

2. Select **Manual Calibration** and press **↵ Enter**.

This screen appears:

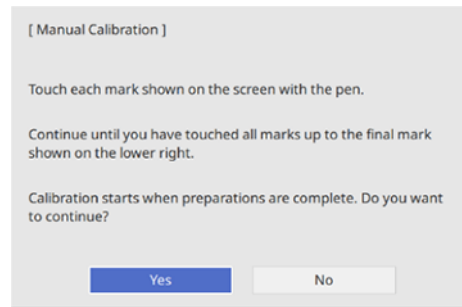

3. Adjust the image focus, if necessary.
4. Press **↵ Enter** to select **Yes**.
A green circle appears in the upper left corner of your projected image.
5. Touch the center of the circle with the tip of the pen.
The circle disappears, and you see another circle below the first one.

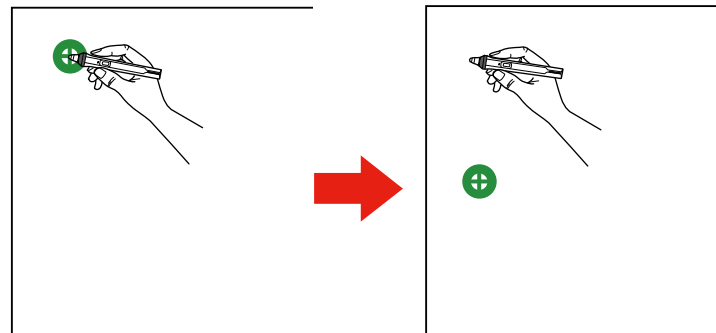

Note: For the most accurate calibration, make sure you touch the center of the circle.

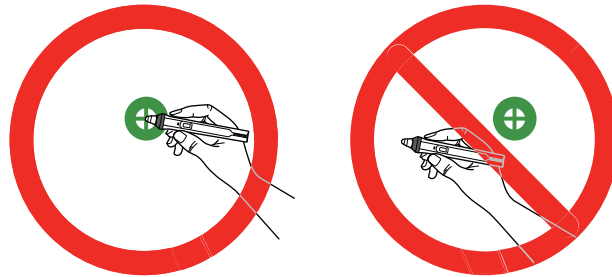

Note: Make sure you are not blocking the signal between the pen and the interactive receiver (next to the projector lens).

6. Touch the center of the next circle, then repeat. When you get to the bottom of the column, the next circle appears at the top of a new column.

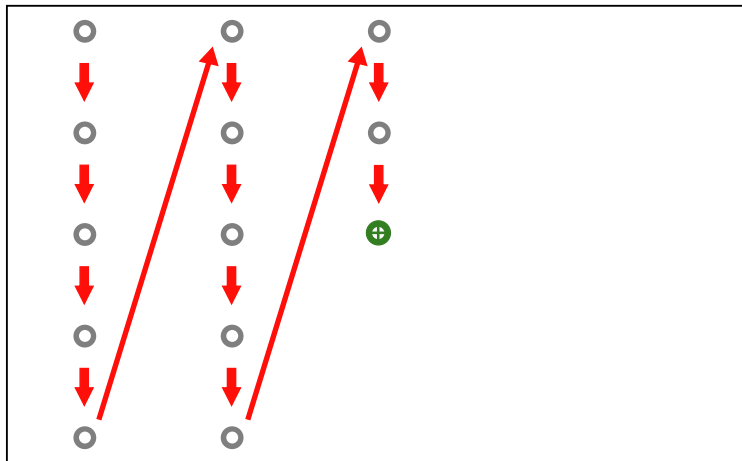

Note: If you make a mistake, press the **Esc** button on the remote control or control panel to go back to the previous circle. To cancel the calibration process, press and hold the **Esc** button for 2 seconds.

7. Continue until all of the circles disappear.

Parent topic: [Pen Calibration](#)

Using Finger Touch Interactivity

You can use your finger to perform the same functions as the interactive pens when you install the Touch Unit.

Note: See the online *Installation Guide* for detailed instructions on installing the Touch Unit (BrightLink 1485Fi). If your product did not come with a Touch Unit, you can use a compatible Touch Unit that you already have or you can purchase one as an optional accessory (BrightLink 1480Fi).

[Touch Unit Safety Instructions](#)

[Performing Touch Unit Angle Adjustment](#)

[Calibrating for Finger Touch Interactivity](#)

[Using Finger Touch Operations](#)

Parent topic: [Using the Interactive Features](#)

Touch Unit Safety Instructions

The Touch Unit enables finger touch interactivity with your projector. Do not connect it to any other projectors or devices.

A built-in, high-power laser is emitted from the laser diffusion ports on the bottom of the Touch Unit.

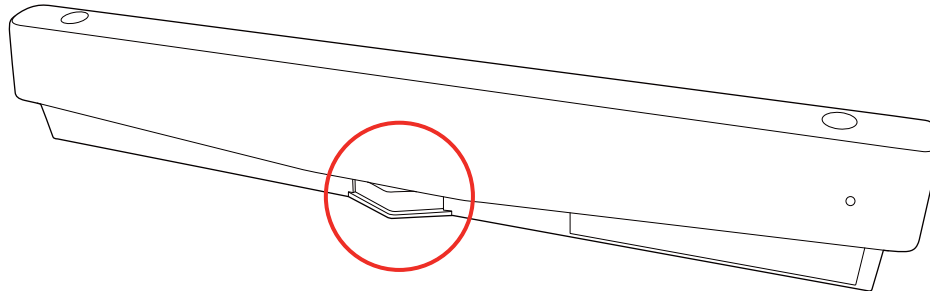

Follow these precautions when using the Touch Unit and finger touch interactivity:

- Children using finger touch interactivity should always be accompanied by an adult.
- Never disassemble or modify the Touch Unit. Never open any cases on the projector or Touch Unit. Electrical voltages inside the projector can cause severe injury.

- Do not look into the laser diffusion ports on the back of the Touch Unit. The laser can damage your eyes. Extra care should be taken when children are present.
- Do not allow the laser light from the Touch Unit to pass through or be reflected by any optical devices, such as a magnifying glass or mirror. This could cause personal injury or fire.
- Do not view the laser light from the Touch Unit using an optical device such as an eye loupe, magnifying glass, or microscope, especially within 2.75 inches (70 mm) of the laser diffusion ports. This could damage your eyes.
- Unplug the projector from the electrical outlet and refer all repairs to qualified service personnel if any problems occur with the Touch Unit. Continued use of the Touch Unit may result in fire or accidents, and can also damage your eyes.

The Touch Unit is a Class 1 laser product that complies with IEC/EN60825-1:2007. The labels indicating the Class 3B laser product and warnings are located in the following area on the Touch Unit:



Parent topic: [Using Finger Touch Interactivity](#)

Performing Touch Unit Angle Adjustment

Adjust the angle of the laser light coming from the Touch Unit so that the Touch Unit can detect the position of your fingers. Once you have performed angle adjustment for the Touch Unit, perform touch calibration.

Note: Make sure you have calibrated the pens, installed the Touch Unit, and turned the Touch Unit on before performing angle adjustment. See the online *Installation Guide* for Touch Unit installation information and click the link below for pen calibration instructions.

1. Press the **Menu** button, select the **Installation** menu, and press **↵ Enter**.

Frequently Used Items	Installation
Image	Fixed Installation Off
Signal I/O	Test Pattern
Installation	Setting Plate Installation Guide
Display	Vertical Installation No
Operation	Projection Front/Upside Down
Management	Auto Screen Adjustment
Network	Geometry Correction Point Correction
Pen/Touch	Digital Zoom
Interactive	Connect ELPCB02 Off
Multi-Projection	Touch Unit
Memory	Remote Receiver Off
ECO	Screen Type 16:9
Initial/All Settings	High Altitude Mode Off
	Reset Installation Settings
	Display
	Pattern Display
	Pattern Type

2. Select **Touch Unit** and press **↵ Enter**.

[Touch Unit]	Return
Installation Pattern	
Power	On
Touch Unit Setup	
Touch Calibration	
Calibration Range	Wide

3. Select **Touch Unit Setup** and press **↵ Enter**.

The following screen appears:

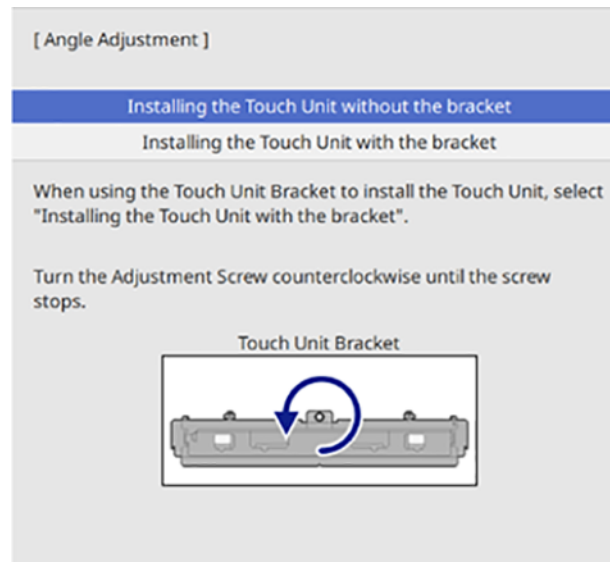

4. Select the option for the Touch Unit installation method that was used and press **↵ Enter**.
5. If you are using the Touch Unit Bracket, turn the adjustment screw on the bracket counterclockwise until it stops.
6. Attach the two markers to the positions shown on the projected screen making sure the thinner ends of the markers are facing the Touch Unit.

Note: Do not place anything other than the markers near the projected image during angle adjustment. If other objects are on or near the projected image, angle adjustment may not be performed correctly.

7. Move each marker over the projected cross until the lines of the cross align with the lines on the marker. Make sure to match the positions so that the crosses overlap with the points on the marker positions.

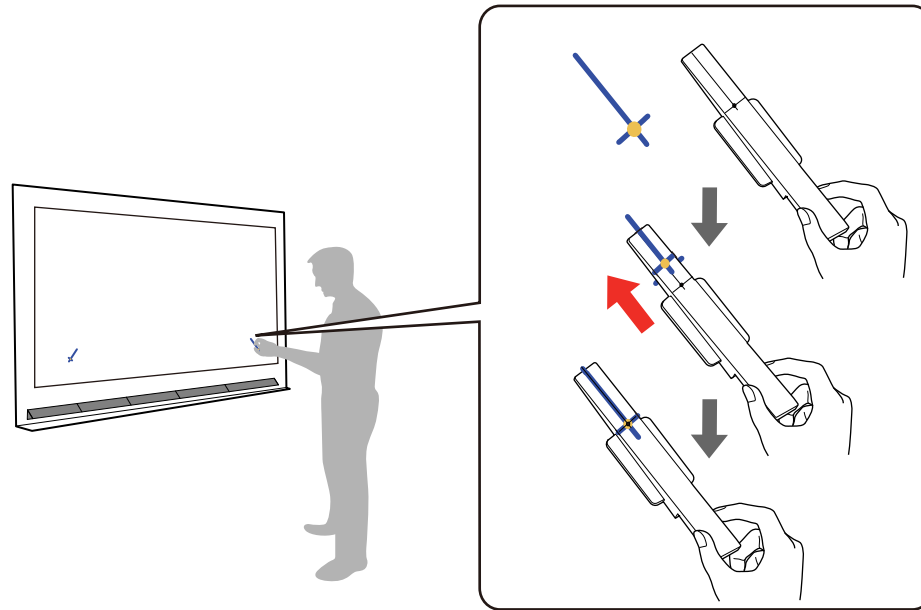

Note: If the magnets won't attach to the screen completely, wipe the area to remove any dirt and try again. For non-magnetic screens, use the supplied tape to secure the markers.

8. Press **↵ Enter** on the remote control or control panel to begin the auto adjustment.
9. When adjustments are complete, remove the markers.

Note: If auto adjustment fails, follow the instructions on the screen to manually adjust the angle of the laser and run auto adjustment again.

10. Touch each of the four yellow circles on the screen and verify that the gray touch indicator appears in the correct position.

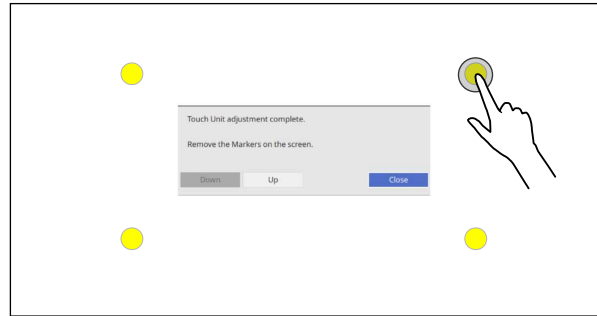

Note: Finger touch operations may not function correctly if you are wearing bandages, artificial nails, nail polish, or anything else that may obstruct your fingers.

If the gray indicators do not appear where you touched the screen, you need to manually adjust the touch unit alignment.



11. Select **Up** using the remote control or control panel and press **↵ Enter**.

Try touching the four dots again and repeat this process until the touch indicators appear in the correct position.

12. When you are finished with adjustments, select **Close**.

Parent topic: [Using Finger Touch Interactivity](#)

Related tasks

[Calibrating for Finger Touch Interactivity](#)

Calibrating for Finger Touch Interactivity

Finger touch calibration coordinates the positioning of your finger with the location of the cursor.

Note: Make sure you have calibrated the pens, installed the Touch Unit, performed angle adjustment, and turned the Touch Unit on before calibrating for finger touch interactivity. See the online *Installation Guide* for Touch Unit installation information.

1. Press the **Menu** button, select the **Installation** menu, and press **↵ Enter**.

Frequently Used Items	Installation
Image	Fixed Installation Off
Signal I/O	Test Pattern
Installation	Setting Plate Installation Guide
Display	Vertical Installation No
Operation	Projection Front/Upside Down
Management	Auto Screen Adjustment
Network	Geometry Correction Point Correction
Pen/Touch	Digital Zoom
Interactive	Connect ELPCB02 Off
Multi-Projection	Touch Unit
Memory	Remote Receiver Off
ECO	Screen Type 16:9
Initial/All Settings	High Altitude Mode Off
	Reset Installation Settings
	Display
	Pattern Display
	Pattern Type

2. Select **Touch Unit** and press **↵ Enter**.

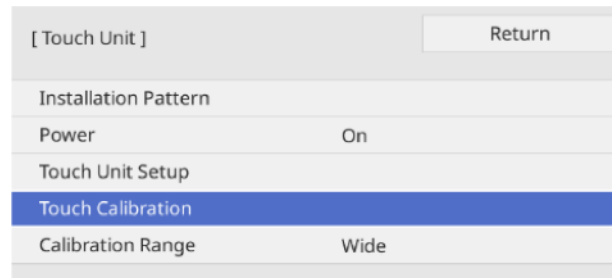

3. Select **Touch Calibration** and press **↵ Enter**.
The following screen appears:

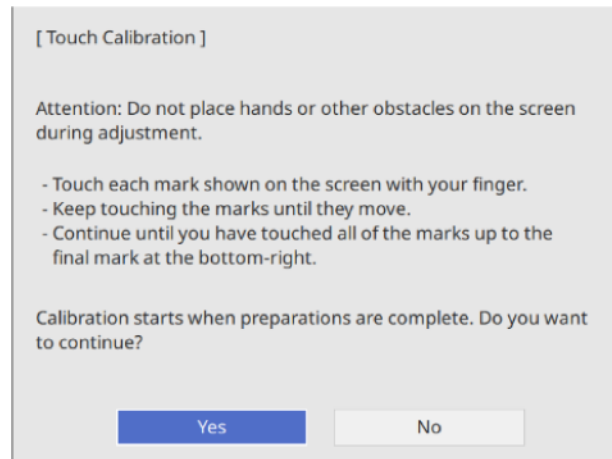

Note: If **Touch Calibration** is disabled, make sure **Power** is set to **On**.

4. Adjust the image focus, if necessary.
5. Press **↵ Enter** to select **Yes**.
A green circle appears in the upper left corner of your projected image.

6. Touch and hold the center of the circle with your finger until the circle disappears and another circle appears, then release it.

The circle disappears, and you see another circle below the first one.

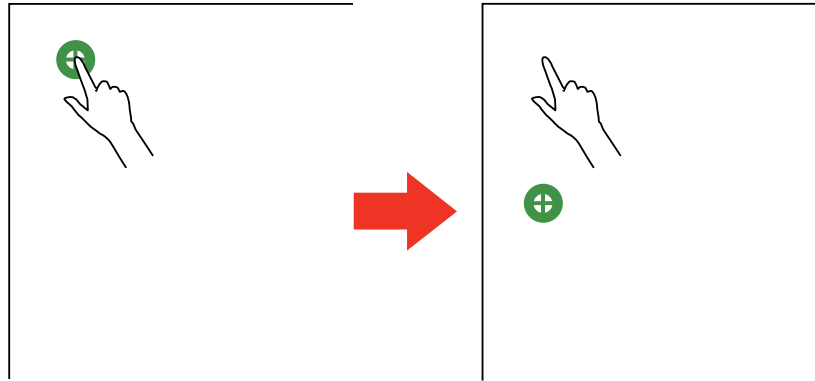

Note: For the most accurate calibration, make sure you touch the center of the circle with the tip of your finger.

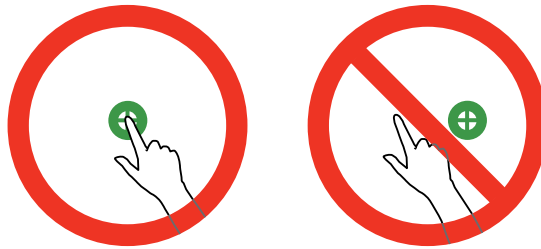

Note: Make sure you are not blocking the signal between your finger and the interactive receiver (next to the projector lens).

7. Touch the center of the next circle with your finger and continue until all of the circles disappear.

When you get to the bottom of a column, the next circle appears at the top of a new column.

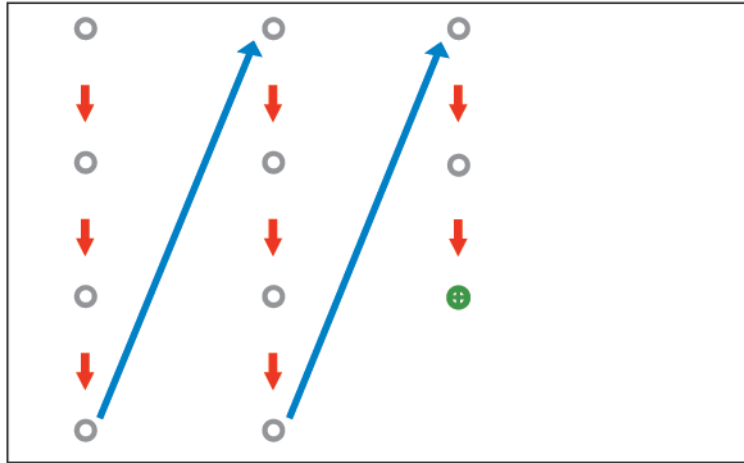

Note: If you make a mistake, press the **Esc** button on the remote control or control panel to go back to the previous circle. It may take several seconds after all of the dots have disappeared for touch calibration to be completed. To cancel the calibration process, press and hold the **Esc** button for 2 seconds.

8. If the cursor location and your finger position do not match, repeat these steps to calibrate again.

Parent topic: [Using Finger Touch Interactivity](#)

Related concepts

[Pen Calibration](#)

Related references

[Pen and Touch Setup Settings - Pen/Touch Menu](#)

[Installation Settings - Installation Menu](#)

Related tasks

[Performing Touch Unit Angle Adjustment](#)

Using Finger Touch Operations

You can use your finger to interact with the projected screen, just as you would use an interactive pen. You can use either a pen or your finger, or use both at the same time.

When performing touch operations with your finger, you can use up to six fingers (depending on the interactive mode, operating system, and connection type).

Note: A Touch Unit is optional for the BrightLink 1480Fi and must be installed for finger touch operation.

1. Install the Touch Unit as described in the online *Installation Guide*.

Note: If you are using an older Touch Unit, refer to the installation guide for that model.

2. Turn on your projector. This automatically turns on the Touch Unit also.
The blue light on the Touch Unit turns on.

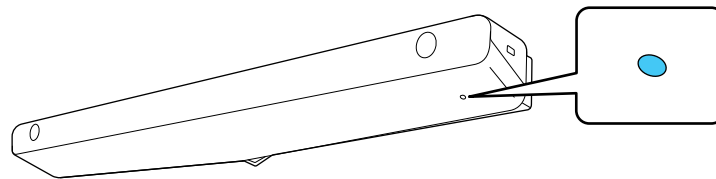

Note: If the blue light does not turn on, press the **Menu** button on the remote control and make sure the **Installation > Touch Unit > Power** setting is set to **On**.

3. Calibrate the pens.
4. Adjust the angle of the Touch Unit as described in the online *Installation Guide*.

Note: If you are using an older Touch Unit, refer to the angle adjustment steps in the installation guide for that model.

5. Calibrate for finger touch interactivity.

6. To write or draw on the projection surface, do the following:

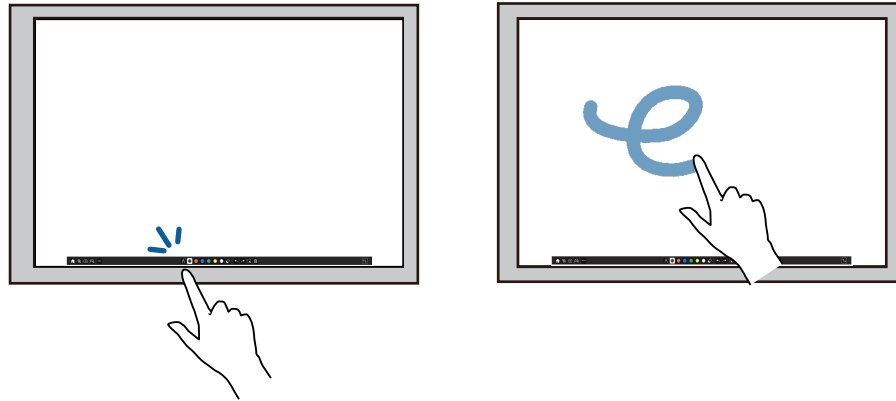

- To select a projected item, such as an icon, tap the projection surface with your finger.
- To draw on the projected screen, tap the projection surface with your finger and drag it as necessary.

7. To use your finger as a mouse in PC Interactive mode, do the following:

- To left-click, tap the board with your finger.
- To double-click, tap twice with your finger.
- To right-click, press the board with your finger for about 3 seconds (Windows).
- To click and drag, press on and drag an item with your finger.
- To scroll, drag your finger on the screen.



8. If your operating system supports these functions, you can also do the following:
 - To zoom in or out, touch an item using two fingers and either move your fingers away from each other (zoom in) or toward each other (zoom out).
 - To rotate an image, touch the image with your fingers and rotate your hand.
 - To drag up or down on a page, or move backward or forward in a browser window, use swiping gestures or flicks.

Note: Finger touch operations may not work correctly with long or artificial nails, or fingers wearing bandages. If your fingers are too close together or crossed, or your sleeve or free hand touches the screen, finger touch may not be recognized. Some operating systems may not support gestures such as flicks.

Parent topic: [Using Finger Touch Interactivity](#)

Related references

[Pen and Touch Setup Settings - Pen/Touch Menu](#)

[Installation Settings - Installation Menu](#)

Using BrightLink with a Computer

You can connect a computer to the projector and install the Easy Interactive Tools software from the website. Make sure your computer is connected to the **USB-B** port on the projector or the control pad (BrightLink 1485Fi) with a USB cable. You can then do the following:

- Use the pens or your finger as a mouse to control your computer
- Use the Easy Interactive Tools software to annotate with both pens or a combination of pen and finger touch at the same time

Note: A Touch Unit is optional for the BrightLink 1480Fi and must be installed for finger touch operation.

Note: See the online *Easy Interactive Tools Operation Guide* for detailed information.

- Save and print your annotations
- Use the Tablet PC input panel in Windows 10, Windows 8.x, or Windows 7
- Use Ink Tools for annotation in Microsoft Office (2007 or later) applications
- Connect to a remote computer and control it with the interactive pens or your finger

- Annotate across two projectors (BrightLink 1485Fi)

[Adjusting the Pen Operation Area](#)

[Easy Interactive Tools](#)

Parent topic: [Using the Interactive Features](#)

Adjusting the Pen Operation Area

If you connect a different computer or adjust the computer's resolution, the pen operation area is adjusted automatically to match your mouse pointer position. If you notice that the pen position is incorrect when using PC Interactive mode, you can adjust the pen area manually.

Note: Manual adjustment is not available when projecting from a LAN source.

Note: To perform manual pen area adjustment, the computer must be connected to the **USB-B1** port on the projector or the **USB-B** port on the projector control pad (BrightLink 1485Fi).

1. Project your computer's desktop.
2. Press the **Menu** button, select the **Pen/Touch** menu, and press **↵ Enter**.

Frequently Used Items	Pen/Touch
Image	Auto Calibration
Signal I/O	Manual Calibration
Installation	Touch Unit
Display	Installation of Projectors
Operation	Pen Hovering On
Management	PC Interactivity
Network	Reset Pen/Touch Settings
Pen/Touch	Interactive
Interactive	Drawing Function On
Multi-Projection	Display Toolbars Always Show
Memory	Display Drawing Area
ECO	Confirm Clear Screen On
Initial/All Settings	Pen Button Function Eraser
	Display Clock Date & Time ^
	Date YYYY-MM-DD
	Time HH:MM
	Print

3. Select the **PC Interactivity** setting and press **↵ Enter**.
You see a screen like this:

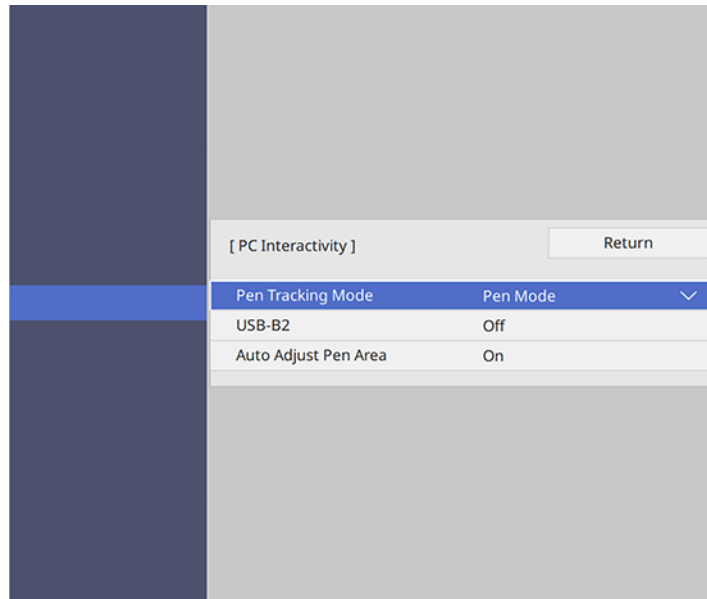

4. Make sure **Auto Adjust Pen Area** is set to **Off**, then select **Manual Adj. Pen Area** and press **↵ Enter**.
You see this screen:

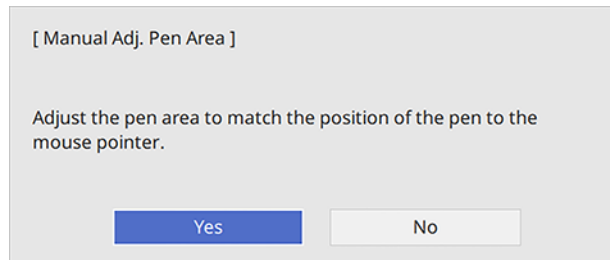

5. Press **↵ Enter** to select **Yes**.

The mouse pointer moves toward the top left corner.

6. When the mouse pointer stops, touch the tip of the pointer with the interactive pen.

The mouse pointer moves toward the bottom right corner.

7. When the mouse pointer stops, touch the tip of the pointer with the interactive pen.

Parent topic: [Using BrightLink with a Computer](#)

Easy Interactive Tools

You can download the Easy Interactive Tools software for use with a computer. Easy Interactive Tools lets you use your interactive pen or finger to draw, save, and interact with projected content from your computer.

Note: A Touch Unit is optional for the BrightLink 1480Fi and must be installed for finger touch operation.

These two modes are available:

- Annotation (PC interactive) mode displays the toolbar on the projected image and lets you use the pen or finger as a mouse to open applications, access links, and operate scroll bars, for example. You can also annotate over whatever is displayed from your computer (using both pens and up to six fingers at the same time).
- Whiteboard mode lets you project on one of 6 background patterns in 3 color options, and use the toolbar to write or draw on the background. You can also import images from your computer or a document camera. In full screen whiteboard mode, two people can use the pens at the same time. Finger touch is also available in whiteboard mode.

Note: For detailed instructions on using the Easy Interactive Tools software, see the online *Easy Interactive Tools Operation Guide* or the online help.

Parent topic: [Using BrightLink with a Computer](#)

Related references

[Additional Projector Software and Manuals](#)

Windows Pen Input and Ink Tools

If you are using Windows 10, Windows 8.x, or Windows 7, you can use the pen input and Ink tools to add input and annotations to your work. You can also use these features over a network when you set the interactive features to be available on your network. See the online *Epson iProjection Operation Guide (Windows/Mac)* for instructions on setting up your computer for network projection.

Enabling Windows Pen Input and Ink Tools
Using Windows Pen Input and Ink Tools

Parent topic: [Using the Interactive Features](#)

Enabling Windows Pen Input and Ink Tools

To use the pen input and Ink tools in Windows 10, Windows 8.x, or Windows 7, you need to adjust the pen operation mode in your projector's menus.

1. Press the **Menu** button, select the **Pen/Touch** menu, and press **↵ Enter**.

Frequently Used Items	Pen/Touch
Image	Auto Calibration
Signal I/O	Manual Calibration
Installation	Touch Unit
Display	Installation of Projectors
Operation	Pen Hovering On
Management	PC Interactivity
Network	Reset Pen/Touch Settings
Pen/Touch	Interactive
Interactive	Drawing Function On
Multi-Projection	Display Toolbars Always Show
Memory	Display Drawing Area
ECO	Confirm Clear Screen On
Initial/All Settings	Pen Button Function Eraser
	Display Clock Date & Time ^
	Date YYYY-MM-DD
	Time HH:MM
	Print

2. Select the **PC Interactivity** setting and press **↵ Enter**.

You see a screen like this:

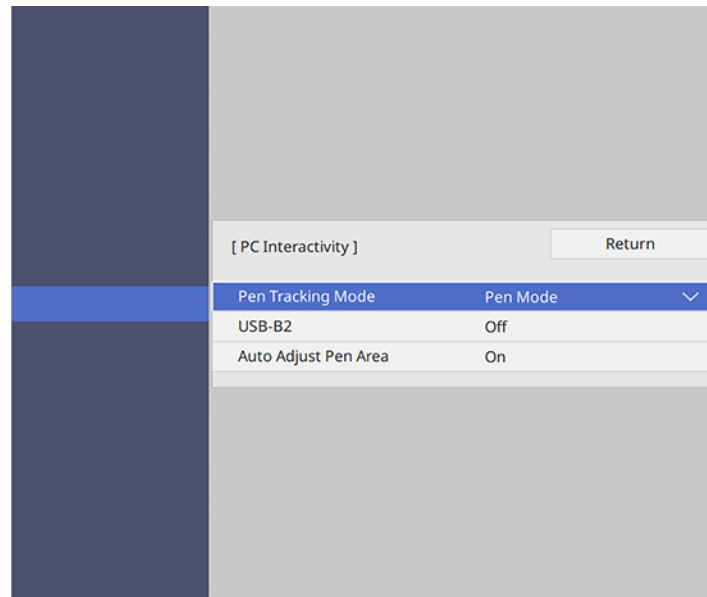

3. Select **Pen Tracking Mode** and press **↵ Enter**.
4. Select **Pen Mode** and press **↵ Enter**.

Parent topic: [Windows Pen Input and Ink Tools](#)

Using Windows Pen Input and Ink Tools

If you are using Windows 10, Windows 8.x, or Windows 7, you can add handwritten input to your work and convert it to text.

If you have Microsoft Office 2007 or later, you can also use the Ink function to add handwritten notes to a Word document, Excel spreadsheet, or PowerPoint presentation.

Note: Option names for the annotation functions may vary depending on your version of Microsoft Office.

- To open the Touch Keyboard in Windows 10, right-click or tap-and-hold on the Taskbar, and select **Show touch keyboard button**. Select the keyboard icon on the screen.

- To open the Touch Keyboard in Windows 8.x, right-click or tap-and-hold on the Taskbar, and select **Toolbars > Touch Keyboard**. Select the keyboard icon on the screen and select the pen icon.
- To open the Tablet PC input panel in Windows 7, select  > **All Programs > Accessories > Tablet PC > Tablet PC Input Panel**.

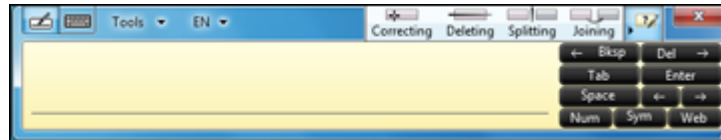

You can write in the box using the interactive pen or your finger, and select from a variety of options to edit and convert the text.

Note: A Touch Unit is optional for the BrightLink 1480Fi and must be installed for finger touch operation.

- To add Ink annotations in Microsoft Office applications, select the **Draw** tab. If the **Draw** tab does not appear in your Microsoft Office application, change the **Pen Tracking Mode** setting in the projector's menus.

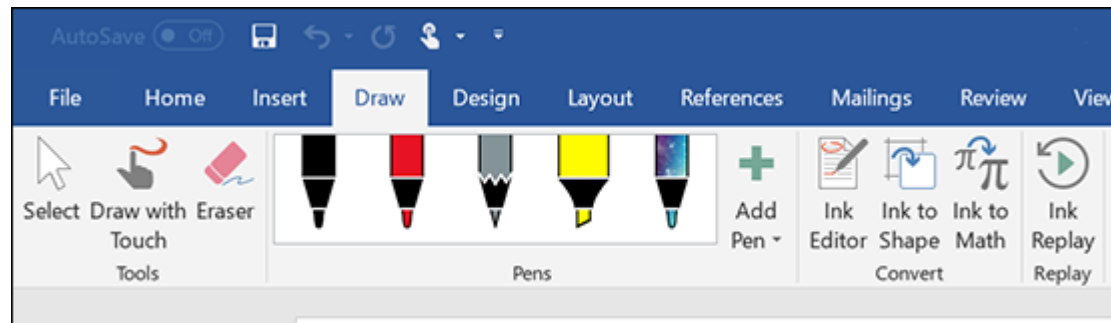

- To annotate your PowerPoint slides in Slideshow mode, press the button on the side of the interactive pen or press the projection surface with your finger for about 3 seconds, and select **Pointer Options > Pen** from the pop-up menu.

For more information about these features, see Windows Help.

Parent topic: [Windows Pen Input and Ink Tools](#)

Whiteboard Mode

You can use the pens and your fingers to write or draw on the projection surface just as you would on a chalkboard or dry erase board. A maximum of two pens and six fingers can be used at the same time. See these sections for instructions.

Note: A Touch Unit is optional for the BrightLink 1480Fi and must be installed for finger touch operation.

[Using the Whiteboard Toolbar](#)

[The Whiteboard Toolbar](#)

[Selecting Background Templates](#)

[Inserting and Working With Images](#)

[Selecting Whiteboard Settings](#)

[Selecting a Networked Device Source](#)

[Saving Pages in Whiteboard Mode](#)

[Printing Whiteboard Pages](#)

[Emailing Whiteboard Pages](#)

Parent topic: [Using the Interactive Features](#)



Using the Whiteboard Toolbar

You can use both pens and your fingers to interact with the screen and whiteboard toolbar.

1. Press the **Home** button on the remote control and select **Whiteboard**.

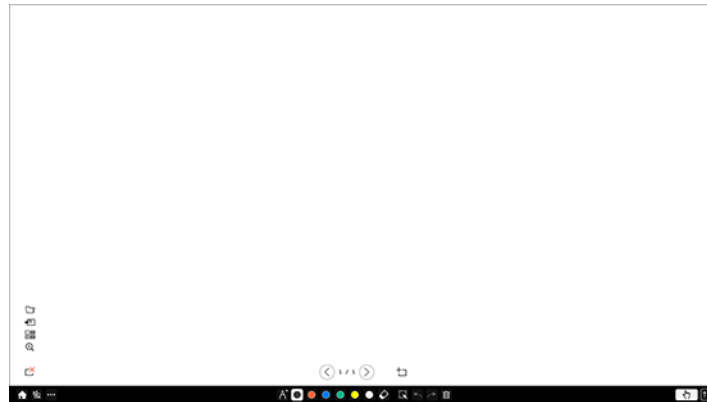
You see the whiteboard screen, with the whiteboard toolbar at the bottom:



2. To move the toolbar to the right, left, top, or bottom of the screen, drag it to the desired location.
3. To add a new page, select the  New page icon above the toolbar.
4. To show or hide the projector control toolbar, select the  icon.

Note: You can also show or hide the toolbar by setting the **Interactive > Display Toolbars** setting to **Always Show** or **Hide for Set Time**.



Parent topic: [Whiteboard Mode](#)













The Whiteboard Toolbar







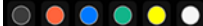

The whiteboard toolbar lets you draw, write, and insert images and shapes.

Note: A mini toolbar also appears when you press the button on the interactive pen anywhere in the drawing area. You can use the mini toolbar to switch the type of pen or eraser. You can change the function of the button by changing the **Pen Button Function** setting in the Interactive menu.









	Displays the Home screen.
	Toggles the video and audio off and on.

	<p>Displays additional tools.</p> <ul style="list-style-type: none">  Mail: Shares the projected screen with an email recipient (set up the Mail settings in the Interactive menu first).  Save: Saves the projected screen (set up the Save settings in the Interactive menu first).  Print: Prints the projected screen from a printer on the same network (set up the Print settings in the Interactive menu first).  Timer: Counts the time up or down.  Volume: Adjusts the projector's volume.  Share Projection: Shares the current screen with devices connected using Epson iProjection.  Participant List: Displays the user selection screen so you can project from devices connected to the projector over a network.  Guidance: Displays the help screen for the toolbar functions. Select Close to close the help screen. <p>Clear all drawing contents: Clears all current drawings and images and returns the whiteboard mode to its default status.</p>
	<p>Displays the available pen type, thickness, or shape.</p> <p> (Yellow/Green/Aqua/Pink/Red/Blue for highlighter): Select the color for the type of pen/shape from the options.</p>
	<p>Switches to the eraser tool to erase content from the whiteboard. Select the size of the eraser.</p>

	<p>Selects all objects and images in a rectangular area. Specify the area by drawing on the projection surface. You can also tap an object or image to select it.</p> <ul style="list-style-type: none"> • To cancel the current selection, tap an empty area on the board. • Drag the edge of the area to enlarge or reduce the object or image. • Drag the  icon at the top of the area to rotate the selected object or image. • To perform the following operations, select the  icon at the bottom right of the selected object or image: <ul style="list-style-type: none"> • Duplicate • Copy • Paste (tap the location where you want to paste) • Delete
	Undoes the previous action.
	Restores a cancelled action.
	Clears all drawings from the displayed page.
	Disables touch input temporarily to prevent unintended operation. Tap again to enable touch operation.
	Hides the toolbar. Tap again to show the toolbar.

Additional Functions in Whiteboard Mode

	Opens a file into a new whiteboard page.
	Imports an image to the current whiteboard page.
	Selects from 6 pre-installed background templates in 3 different colors.
	Enlarges or reduces the projected image (not available when the whiteboard screen is split with the annotation screen).
	Deletes the current whiteboard page.
	Displays the previous whiteboard page.

>	Displays the next whiteboard page.
	Adds a new whiteboard page after the current page. You can have up to 20 whiteboard pages.



Follow these guidelines when using the whiteboard toolbar:

- You can display images of up to 2 files per page at 1920 × 1080 pixels on the whiteboard screen (including images stored on the clipboard).
- To paste an image, you need to use the same pen that you used to cut or copy the image.
- Drawn objects are displayed at the front of the projected page.
- If objects or images are moved out of the projected screen, you may not be able to select them.

Parent topic: [Whiteboard Mode](#)

Selecting Background Templates

In whiteboard mode, you can insert horizontal or vertical lines, a graph-paper grid, or another background template and place it on your whiteboard pages. You can select from 6 pre-installed templates in 3 different colors.

1. In Whiteboard mode, select the  icon to the left of the toolbar.
You see the available templates.
2. Select one of the template patterns or select  to import an image.

Note: To import a template image, connect to a USB flash drive or a shared directory containing a JPG or PNG file. The background image can be 1920 × 1080 pixels or smaller (smaller images will not fill the page).

Parent topic: [Whiteboard Mode](#)

Inserting and Working With Images



In Whiteboard mode, you can use the  Insert Image tool to insert an image from a USB flash drive or a network folder. Images can be in .png or .jpg format, with a maximum size of 2048 × 2048 pixels. You can also scan a document or image into a new page using a supported Epson all-in-one printer connected to the same network or the projector control pad (BrightLink 1485Fi). Once the image is projected, you can move, resize, or rotate it.

Note: You can also use the  tool to the left of the toolbar to import files (including .pdf files) in whiteboard mode.

Note: You cannot scan with standalone scanners or printers that have run out of ink or cannot print. Only Epson All-in-One products that support ESC/P-R commands are supported. When importing from a scan, you cannot use the scan button, the partial document or image scanning function, or the Automatic Document Feeder (ADF), even if these are available on your product.

1. Select the  Insert Image tool.
2. Do one of the following:
 - Select **USB** or **Network**, then locate and select the image you want to add.
 - Load your original in the scanner, select **Scan**, and choose the settings for the scanned image as necessary.
3. Select **Open** or **Scan**.

After a moment, the image appears on the whiteboard page.

4. Select the  Select tool and do any of the following as necessary:
 - To move the image, touch inside it and drag the image.
 - To resize the image, touch any corner and drag inward to shrink or outward to enlarge.
 - To rotate the image, touch the  icon at the top of the image and drag left or right.
5. Use the menu in the bottom right corner of the image to select any of the following as necessary:
 - **Duplicate** creates a copy of the image on the current whiteboard page.
 - **Copy** copies the image on the whiteboard. Touch a location on the screen to paste a copy of the image.
 - **Paste** creates a new copy of the image. Drag the image to the desired location.
 - **Delete** removes the image from the whiteboard.

When you are finished, select any other tool from the whiteboard toolbar to exit image editing mode.

Parent topic: [Whiteboard Mode](#)

Selecting Whiteboard Settings

Follow the instructions in these sections to select settings for capturing, scanning, saving, printing, and emailing in Whiteboard mode.

Note: If the **Menu Protection** password setting is set to **On** for the **Interactive** option, you cannot change settings in the **Interactive** menu.

[Selecting Basic Whiteboard Settings](#)

[Selecting Whiteboard Print Settings](#)

[Selecting Settings for Saving Whiteboard Pages](#)

[Selecting Settings for Emailing Whiteboard Pages](#)

[Selecting Settings for a Directory Server](#)

Parent topic: [Whiteboard Mode](#)

Related tasks

[Selecting Password Security Types](#)

[Setting a Password](#)

Selecting Basic Whiteboard Settings

You can select the whiteboard features you want to use and control the way whiteboard pages are saved in the projector.

1. Press the **Menu** button on the remote control.
2. Select the **Interactive** menu and press **↵ Enter**.

Frequently Used Items	Interactive
Image	Drawing Function On
Signal I/O	Display Toolbars Always Show
Installation	Display Drawing Area
Display	Confirm Clear Screen On
Operation	Pen Button Function Eraser
Management	Display Clock Date & Time ^
Network	Date YYYY-MM-DD
Pen/Touch	Time HH:MM
Interactive	Print
Multi-Projection	Save
Memory	Mail
ECO	Directory
Initial/All Settings	Reset Interactive Settings
	Multi-Projection
	Projector ID Off
	HDMI Out Setting Off v
	Geometry Correction Point Correction

3. Select the following options as necessary:
 - **Drawing Function** displays the interactive toolbar
 - **Display Toolbars** sets when to display the interactive toolbar
 - **Display Drawing Area** displays the available drawing area
 - **Confirm Clear Screen** displays a confirmation screen before clearing all the drawings from the projected screen
 - **Pen Button Function** selects the operation performed by the button on the side of the interactive pen
 - **Display Clock** sets the date and time display format on the whiteboard toolbar (set the date and time in the **Management** menu)
 - **Print** shows the **Print** menu settings
 - **Save** shows the **Save** menu settings
 - **Mail** shows the **Mail** menu settings
 - **Directory** shows the **Directory** menu settings
 - **Reset Interactive Settings** resets all adjustment values on the **Interactive** menu to their default settings
4. When you finish selecting settings, press the **Menu** button to exit the menus.

Parent topic: [Selecting Whiteboard Settings](#)

Selecting Whiteboard Print Settings

You can select the default settings for printing whiteboard pages from the projector.

1. Press the **Menu** button.

2. Select the **Interactive** menu and press **↵ Enter**.

Frequently Used Items	Interactive
Image	Drawing Function On
Signal I/O	Display Toolbars Always Show
Installation	Display Drawing Area
Display	Confirm Clear Screen On
Operation	Pen Button Function Eraser
Management	Display Clock Date & Time ^
Network	Date YYYY-MM-DD
Pen/Touch	Time HH:MM
Interactive	Print
Multi-Projection	Save
Memory	Mail
ECO	Directory
Initial/All Settings	Reset Interactive Settings
	Multi-Projection
	Projector ID Off
	HDMI Out Setting Off v
	Geometry Correction Point Correction

3. Select **Print** and press **↵ Enter**.
4. Select the following printing options as necessary:

- **Printer** lets you select either **USB Printer** or **Network Printer** as the printer connection.

Note: Selecting **USB Printer** will also enable scanning from Epson all-in-one printers. Only Epson printers are supported via USB connection.

- **Printer Address** lets you enter an IP address for a printer connected to the same network as the projector.

Note: You cannot use the following IP addresses: 127.x.x.x, 192.0.x.x, or 224.0.0.0 through 255.255.255.255 (where x is a number from 0 to 255). To return the IP address to its default value, enter 0.0.0.0.

- **Printer Type** lets you manually select the printer type or let the projector automatically determine the printer type (in most cases, you should leave this setting as **Auto Detect**).

- **PCL Type** lets you select the PCL type to match the printer type and settings of the connected network printer.

Note: If printing fails when using a PCL6 printer in **Normal** mode, try printing in **Mode 1** or **Mode 2**.

- **Test Print** lets you send a test page to the connected printer.
- **Default Paper Size** lets you select either **Letter** or **A4** as the default paper size.

Note: Use the displayed keyboard to enter the IP address if necessary. Press the arrow buttons on the remote control to highlight numbers and press **↵ Enter** to select them.

5. When you finish selecting settings, press the **Menu** button to exit the menus.

Parent topic: [Selecting Whiteboard Settings](#)

Selecting Settings for Saving Whiteboard Pages

You can select the default settings for saving whiteboard pages from the projector.

1. Press the **Menu** button.
2. Select the **Interactive** menu and press **↵ Enter**.

Frequently Used Items	Interactive
Image	Drawing Function On
Signal I/O	Display Toolbars Always Show
Installation	Display Drawing Area
Display	Confirm Clear Screen On
Operation	Pen Button Function Eraser
Management	Display Clock Date & Time ^
Network	Date YYYY-MM-DD
	Time HH:MM
Pen/Touch	Print
Interactive	Save
Multi-Projection	Mail
Memory	Directory
ECO	Reset Interactive Settings
Initial/All Settings	Multi-Projection
	Projector ID Off
	HDMI Out Setting Off v
	Geometry Correction Point Correction

3. Select the **Save** menu and press **↵ Enter**.
4. Select the following options as necessary:
 - **USB Storage** lets you save whiteboard page files to a USB thumbdrive.
 - **PC via USB Cable** lets you save whiteboard page files to a device connected to the projector with a USB cable.
 - **Network Folder** lets you save whiteboard page files to a network folder.
 - **CIFS Server** lets you set the CIFS server's IP address or fully qualified domain name (FQDN). You can enter up to 64 alphanumeric characters.

Note: You cannot use the following characters: " ' + , ; < = > ? [\] ` | or spaces. If you need to enter more characters, enter them using the Web Config utility. To use a FQDN, you must configure a DNS server. You cannot use the following IP addresses: 127.x.x.x, 192.9.2.x, or 224.0.0.0 to 255.255.255.255.

- **Shared Folder Path** lets you enter the network folder name in this format: share_name\folder_name or share name. You can enter up to 64 alphanumeric characters. You cannot use the following characters: " * / : < > ? or |.
- **User name** lets you enter a user name with read/write privileges on the network folder. You can enter up to 64 alphanumeric characters. You can enter a domain name by adding it before the user name and separating them with a backslash in this format: domain\username. Do not use a colon (":") or spaces.
- **Password** lets you enter a password for the user name you entered. You can enter up to 64 alphanumeric characters. After you enter the password and select **OK**, the password is hidden. Do not use a colon (":") or spaces.
- **Check Connection** lets you test the network connection.
- **Always apply password** lets you require that whiteboard files must be saved as password-protected PDF or EWF2 files.

Note: Use the displayed keyboard to enter the address, user name, and password if necessary. Press the arrow buttons on the remote control to highlight numbers and press **↵ Enter** to select them.

5. When you finish selecting settings, press the **Menu** button to exit the menus.

Parent topic: [Selecting Whiteboard Settings](#)

Selecting Settings for Emailing Whiteboard Pages

You can select the settings for emailing whiteboard pages from the projector.

1. Press the **Menu** button on the remote control.
2. Select the **Interactive** menu and press **↵ Enter**.

Frequently Used Items	Interactive
Image	Drawing Function On
Signal I/O	Display Toolbars Always Show
Installation	Display Drawing Area
Display	Confirm Clear Screen On
Operation	Pen Button Function Eraser
Management	Display Clock Date & Time ^
Network	Date YYYY-MM-DD
Pen/Touch	Time HH:MM
	Print
Interactive	Save
Multi-Projection	Mail
Memory	Directory
ECO	Reset Interactive Settings
Initial/All Settings	Multi-Projection
	Projector ID Off
	HDMI Out Setting Off v
	Geometry Correction Point Correction

3. Select the **Mail** menu and press **↵ Enter**.
 4. Select the following options for emailing as necessary:
 - **Mail Function** lets you share captured whiteboard pages via email.
 - **SMTP Server** lets you enter the IP address or fully qualified domain name (FQDN) for the mail server. You can enter up to 64 alphanumeric characters. If you specify an FQDN, you must configure a DNS server. Do not use spaces or the following symbols: " * + , ; < = > ? [\] ` |
- Note:** You cannot use the following IP addresses: 127.x.x.x, 192.0.2.x, or 224.0.0.0 to 255.255.255.255 (where x is a number from 0 to 255).
- **Port Number** lets you enter a port number for the SMTP server. The default port is 25 when set to **Open**, 465 for **SSL**, and 587 for **TLS**.

- **Authentication** lets you set the type of authentication expected by the mail server.
- **User name** lets you enter a user name for the mail server. You can enter up to 64 alphanumeric characters. Do not use a colon (":") or spaces.
- **Password** lets you enter a password for the mail server. You can enter up to 64 alphanumeric characters. Do not use a colon (":") or spaces.
- **From** lets you enter the email address to be displayed to the sender. You can enter up to 64 alphanumeric characters. Do not use spaces or the following symbols: " () , ; < > [\]
- **Default e-mail address** lets you enter an optional address for testing. You can enter up to 64 alphanumeric characters. Do not use spaces or the following symbols: " () , ; < > [\]
- **Send a test e-mail** lets you connect to the SMTP server and send a test email to the address you set as the default.
- **Disallow Address Input** controls whether you can enter email addresses manually. When enabled, you can only choose email addresses from an address book or directory service.

Note: Use the displayed keyboard to enter the addresses. Press the arrow buttons on the remote control to highlight numbers or characters and press  **Enter** to select them.

5. When you finish selecting settings, press the **Menu** button to exit the menus.

Parent topic: [Selecting Whiteboard Settings](#)

Selecting Settings for a Directory Server

You can select the settings for specifying a email directory server for your projector.

1. Press the **Menu** button on the remote control.

2. Select the **Interactive** menu and press **↵ Enter**.

Frequently Used Items	Interactive
Image	Drawing Function On
Signal I/O	Display Toolbars Always Show
Installation	Display Drawing Area
Display	Confirm Clear Screen On
Operation	Pen Button Function Eraser
Management	Display Clock Date & Time ^
Network	Date YYYY-MM-DD
Pen/Touch	Time HH:MM
Interactive	Save
Multi-Projection	Mail
Memory	Directory
ECO	Reset Interactive Settings
Initial/All Settings	Multi-Projection
	Projector ID Off
	HDMI Out Setting Off v
	Geometry Correction Point Correction

3. Select **Directory** and press **↵ Enter**.

4. Select the following options as necessary:

- **Directory Access Function** specifies whether to search an active directory server for user names and email addresses.
- **LDAP Server** let you enter the IP address or fully qualified domain name (FQDN) for the LDAP server. You can enter up to 64 alphanumeric characters. Do not use spaces or the following symbols: " * + , ; < = > ? [\] ` |. If you specify an FQDN, you must configure a DNS server.

Note: You cannot use the following IP addresses: 127.x.x.x, 192.0.2.x, or 224.0.0.0 to 255.255.255.255 (where x is a number from 0 to 255).

- **Port Number** lets you enter a port number for the LDAP server. The default port is 389. Specify "3268" to search the global catalog.
- **Authentication** lets you set the type of authentication expected by the LDAP server. If you are using **Digest-MD5** or **Simple** authentication and the **LDAP Server** setting is set to an IP address, you must enable reverse DNS lookup on the DNS server.

- **User Name** lets you enter a user name for the mail server. You can enter up to 64 alphanumeric characters. Use one of the following methods when entering the user name with the domain name: domain name\user name or user name@domain name. Do not use a colon (":") or spaces.
- **Password** lets you enter a password for the LDAP server. You can enter up to 64 alphanumeric characters. Do not use a colon (":") or spaces.
- **Check Connection** tests the network connection.
- **Search Base DN** lets you enter the DN (Distinguished Name) where the search for user names and email addresses should start. You can enter up to 64 alphanumeric characters. Do not use a colon (":") or spaces. This field is case-sensitive.

Note: Make sure you specify the OU (Organizational Unit) and DC (Domain Component) as necessary, with OU first in this format: OU=accounts,DC=example,DC=com. The DN must be at or below the DC level in the database structure.

- **User Attributes** lets you enter a user name, for example, "cn." You can enter up to 64 alphanumeric characters. Do not use a colon (":") or spaces. This field is case-sensitive.
- **Mail Attributes** lets you enter the attribute for the mail address. You can enter up to 64 alphanumeric characters. Do not use a colon (":") or spaces. This field is case-sensitive.
- **Group Attributes** lets you enter the attribute for the user group name. You can enter up to 64 alphanumeric characters. Do not use a colon (":") or spaces. This field is case-sensitive.
- **Search target attributes** lets you enter the search attributes for user name, email address, and user group name. You can enter up to 64 alphanumeric characters. Do not use a colon (":") or spaces. This field is case-sensitive.

Note: The default value is "cn." You can specify up to three keys separated by commas. Do not use three or more commas, commas right at the start or the end, or continuous commas. The search is performed using forward matching and returns all results that start with the search keys.

- **Additional filter** lets you enter an additional filter to **Search target attributes**. You can enter up to 64 alphanumeric characters. Do not use a colon (":") or spaces. This field is case-sensitive.



Note: Use the displayed keyboard to enter the addresses. Press the arrow buttons on the remote control to highlight numbers or characters and press  **Enter** to select them.

5. When you finish selecting settings, press the **Menu** button to exit the menus.

Parent topic: [Selecting Whiteboard Settings](#)

Selecting a Networked Device Source

You can project an image from devices connected to the projector via a network. You can select the image source from computers running Epson iProjection (Windows/Mac) and smartphones or tablets running the Epson iProjection app.

1. Select the  **Other Tools** icon on the projector toolbar.
2. Select  **Participant List**.

You see a list of available devices. The icon next to a user name indicates the currently selected source.

3. Select the user name for the device from which you want to project.

Note: You can select **Thumbnail** to switch the display from user names to thumbnail images of each device's screen. Select **Refresh** to update the user list.

4. Select **Close**.

You see the screen image from the selected device.

While the user selection screen is displayed, you cannot do the following:

- Use other interactive features
- Control the projector from the bottom toolbar
- Connect to multiple projectors
- Hear sound from the projector
- Project an image using Epson iProjection (Windows/Mac)



Note: You cannot access the **Participant List** screen when connecting to multiple projectors by using Epson iProjection (Windows/Mac) and projecting the same image (mirroring).

Parent topic: [Whiteboard Mode](#)

Saving Pages in Whiteboard Mode

You can save your whiteboard pages as JPG, PDF, PNG, or EWF2 files and select the location where you want to store your files.

Note: You must first set up the **Save** settings in the projector's **Interactive** menu. For best results, connect directly to the projector or control pad (BrightLink 1485Fi) to save whiteboard pages. You may not be able to use USB flash drives that incorporate security functions.

1. Select the  **Other Tools** icon on the projector toolbar.
2. Select the  **Save** icon.

You see a screen like the following:

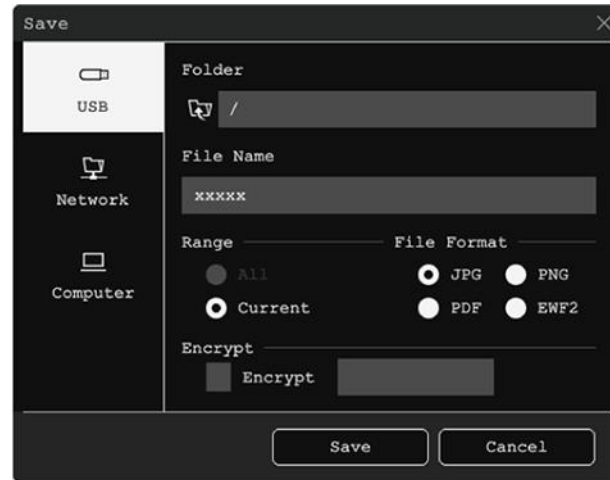

3. Select one of the following as the destination where you want to save your file:
 - **USB** or **Network** to save to a connected USB storage device or network folder
 - **Computer** to temporarily save the file on the projector and make it available for copying from a computer. After you copy the file, it is erased

Note: You cannot save the file to a computer when the input source is USB Display or the HDBaseT control pad (BrightLink 1485Fi), or when you have split the screen into halves or quarters.

4. Select the folder where you want to save your file.
5. To enter a file name, select the **File Name** text box, use the on-screen keyboard to enter a file name.

6. Select one of the following as the **Range** setting:
 - **All** to save all the pages in the current whiteboard session (PDF or EWF2)
 - **Current** to save only the current whiteboard page
7. Select the file format. If you choose **PDF** or **EWF2** (Epson Whiteboard Format), you can encrypt the file and add a password. If you choose **EWF2**, you can reopen the file later and continue editing.

Note: JPG and PNG files are saved as 1920 × 1080 pixels.

8. When you are ready to save the whiteboard pages, select **Save** or **Next**.

Parent topic: [Whiteboard Mode](#)



Printing Whiteboard Pages

You can print your whiteboard pages directly to a printer and select various print settings for them.

The projector supports the following printer control commands:

- Network connection: ESC/P-R and PCL6
- USB connection (Epson printers only): ESC/P-R

Note: You must first set up the **Print** settings in the projector's **Interactive** menu.

1. Select the  **Other Tools** icon on the projector toolbar.
2. Select the  **Print** icon.

You see a screen like the following:





3. Select any of the print settings as necessary.
4. When you are ready, select **Print**.

Parent topic: [Whiteboard Mode](#)

Emailing Whiteboard Pages

If your projector is set up on a network and configured to use an email server, you can email your whiteboard pages as an email attachment directly from the projector.

Note: You must first set up the **Mail** settings in the projector's **Interactive** menu.

1. Select the  **Other Tools** icon on the projector's toolbar.
2. Select the  **Mail** icon.

You see a screen like the following:

The screenshot shows a 'Mail' dialog box with the following fields and options:

- E-mail Address:** A text input field with an address book icon to its right.
- Subject:** A text input field containing 'xxxxxx'.
- File Name:** A text input field containing 'xxxxxx'.
- Range:** Radio buttons for 'All' (selected) and 'Current'.
- File Format:** Radio buttons for 'JPG', 'PNG', 'PDF' (selected), and 'EWF2' (selected).
- Encrypt:** An unchecked checkbox labeled 'Encrypt' followed by a password input field.
- Buttons:** 'Send' and 'Cancel' buttons at the bottom.

3. Tap the **E-mail Address** text box, select **Add** to enter the recipient's email address using the on-screen keyboard, and select **OK**.

Note: If you imported an address book or set up a directory service, you can select up to 50 email addresses by selecting the address book icon.

4. Tap the **Subject** text box and enter the email subject using the on-screen keyboard, and select **OK**.
5. Tap the **File Name** text box and enter the name of the email attachment using the on-screen keyboard, and select **OK**.
6. Select the file format for the email attachment. If you choose **PDF** or **EWF2** (Epson Whiteboard Format), you can encrypt the file and add a password.

7. Select one of the following under **Range**:
 - **All** to attach all the pages in the current whiteboard session (PDF or EWF2 format)
 - **Current** to attach only the current whiteboard page
8. When you are ready to email the whiteboard pages, select **Send**.

Parent topic: [Whiteboard Mode](#)

Using BrightLink Without a Computer

You can use the pens and your fingers to write or draw on the projection surface simultaneously without connecting a computer (PC Free annotation). This lets you annotate images from a document camera, iPad, DVD player, or other source.

Note: A Touch Unit is optional for the BrightLink 1480Fi and must be installed for finger touch operation.

These two modes are available:

- Built-in annotation mode displays the built-in toolbar on whatever image is being projected from a document camera, iPad, or other source.
- Built-in Whiteboard mode lets you project a white screen or one of 6 background patterns in 3 colors, and use the toolbar to write or draw as you would on a chalkboard or dry erase board.

[Using the Built-in Annotation Mode](#)

[Built-in Tools for Use Without a Computer](#)

[Controlling an Epson Document Camera](#)

Parent topic: [Using the Interactive Features](#)

Using the Built-in Annotation Mode

You can use either pen with the built-in toolbar, both pens at the same time, your finger, or a combination of both pen and finger touch.

Note: Make sure the **Drawing Function** setting is set to **On** in the projector's **Interactive** menu.

1. Make sure your device is connected and select the input source you want to display.
You see the toolbar at the bottom of the projected image.
2. To move the toolbar to the right, left, top, or bottom of the screen, use the pen or your finger to drag it to the desired location.

3. Select the drawing tool you want to use from the toolbar and annotate the projected screen using the interactive pens or your fingers.
4. To minimize the toolbar, select the  **Minimize** icon on the right side of the toolbar.







Parent topic: [Using BrightLink Without a Computer](#)













Built-in Tools for Use Without a Computer







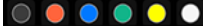



The built-in annotation toolbar is embedded in the projector and allows you to draw and write on the projected screen. Make sure the **PC Interactivity** setting on the toolbar is disabled, if it appears.

Note: A mini toolbar also appears when you press the button on the interactive pen anywhere in the drawing area. You can use the mini toolbar to switch the type of pen or eraser. You can change the function of the button by changing the **Pen Button Function** setting in the Interactive menu.



	Displays the Home screen.
	Toggles the video and audio off and on.
	Enlarges or reduces the projected image (not available when the screen is split into halves or quarters).
	<p>Captures the current screen and copies it to the whiteboard.</p> <p>Full Screen captures the entire screen.</p> <p>Select Area lets you select a portion of the image to capture.</p> <p>Note: If you want to capture the Screen Mirroring image, set Capture to Enabled in the projector's Network > Network Settings > Network Projection menu.</p>
	Splits the screen and displays the whiteboard source with the current source (not available when the screen is split into halves or quarters or when the Scale setting is on.).
	Specifies the split screen settings (available only when you have split the screen into halves or quarters).
	Specifies the horizontal position of the image inside the ultra-wide display (available only when Screen Type is set to 16:6 [BrightLink 1485Fi]).

	<p>Displays additional tools.</p> <ul style="list-style-type: none">  Mail: Shares the projected screen with an email recipient (set up the Mail settings in the Interactive menu first).  Save: Saves the projected screen (set up the Save settings in the Interactive menu first).  Print: Prints the projected screen from a printer on the same network (set up the Print settings in the Interactive menu first).  Timer: Counts the time up or down.  Volume: Adjusts the projector's volume.  Share Projection: Shares the current screen with devices connected using Epson iProjection.  Participant List: Displays the user selection screen so you can project from devices connected to the projector over a network.  Guidance: Displays the help screen for the toolbar functions. Select Close to close the help screen. <p>Clear all drawing contents: Clears all current drawings and images and returns the annotation mode to its default status.</p>
	<p>Displays the available pen type, thickness, or shape.</p> <p> (Yellow/Green/Aqua/Pink/Red/Blue for highlighter): Select the color for the type of pen/shape from the options.</p>
	<p>Switches to the eraser tool to erase content from the whiteboard. Select the size of the eraser.</p>

	<p>Selects all objects and images in a rectangular area. Specify the area by drawing on the projection surface. You can also tap an object or image to select it.</p> <ul style="list-style-type: none"> • To cancel the current selection, tap an empty area on the board. • Drag the edge of the area to enlarge or reduce the object or image. • Drag the  icon at the top of the area to rotate the selected object or image. • To perform the following operations, select the  icon at the bottom right of the selected object or image: <ul style="list-style-type: none"> • Duplicate • Copy • Paste (tap the location where you want to paste) • Delete
	Undoes the previous action.
	Restores the action that was previously undone.
	Clears all drawings from the displayed page.
	Disables touch input temporarily to prevent unintended operation. Tap again to enable touch operation.
	Stops screen sharing (available only when projecting a shared image).
	Toggles the PC Interactivity setting off and on. Set the PC Interactivity setting to On to control the computer using the interactive pens and/or your fingers (not available when projecting a shared image).
	Hides the toolbar. Tap again to show the toolbar.

Follow these guidelines when using the annotation toolbar:

- To paste an image, you need to use the same pen that you used to cut or copy the image.
- Drawn objects are displayed at the front of the projected page.
- If objects or images are moved out of the projected screen, you may not be able to select them.

Parent topic: [Using BrightLink Without a Computer](#)

Controlling an Epson Document Camera

You can control certain document camera features from the projected toolbar when a compatible Epson document camera is connected.

Note: A document camera toolbar is displayed only when an Epson DC-07, DC-13, or DC-21 document camera is connected. You must connect the Epson DC-13 and DC-21 cameras via HDMI and the Epson DC-07 camera via USB to control them from the projector toolbar.

1. Connect an Epson document camera to the projector.

Note: If you are connecting the document camera via HDMI cable, make sure **HDMI Link** is set to **On** in the Signal I/O menu and disable **PC Interactivity** on the interactive toolbar.

You see a toolbar like this at the bottom of the projected image. You can select the following options as available. Depending on your document camera model, options may vary.

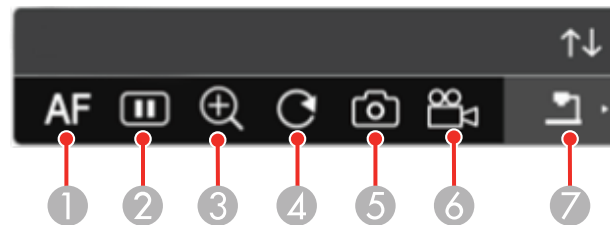

- 1 Automatically focuses the image
- 2 Pauses the image
- 3 Enlarges the image
- 4 Rotates the image 180°
- 5 Captures the image and drawings
- 6 Records the image
- 7 Switches sources to the SD Card Viewer

2. To move the toolbar, use the pen or your finger to drag it to the desired location.

Note: A Touch Unit is optional for the BrightLink 1480Fi and must be installed for finger touch operation.

3. To minimize or expand the toolbar, select the  icon.

Parent topic: [Using BrightLink Without a Computer](#)

Related tasks

[Connecting to a Document Camera](#)

Splitting the Projected Image with Whiteboard Mode

When projecting from an input source in Annotation mode, you can split the screen and open a whiteboard page to interact with simultaneously.

Note: This feature is not available when the screen is split into halves or quarters or the **Scale** setting (BrightLink 1485Fi) is enabled.

1. Turn on the projector and project an image, if necessary.
2. Select the  **Whiteboard** icon on the left side of the toolbar.

You see the whiteboard display on the screen.

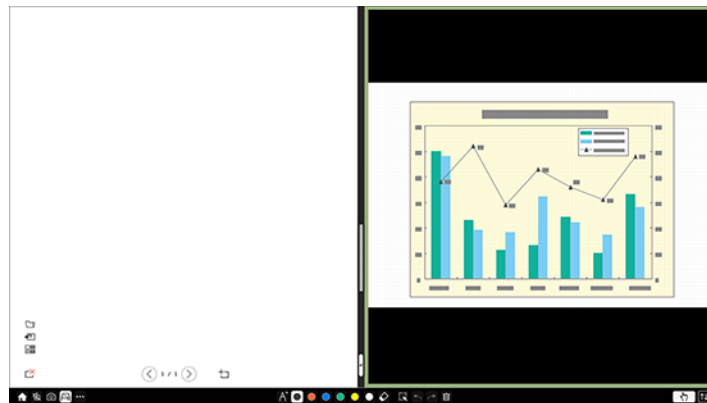

3. To increase either the whiteboard or the projected image, drag the white part of the center divider to the appropriate side.

Note: To enlarge either side to fit the entire screen, drag the white part of the center divider fully to the desired edge of the screen.

4. To swap the projected image and whiteboard from left to right, select the  at the bottom of the center divider.

You cannot perform the following operations during split screen projection:

- E-Zoom
- Switching aspect mode

Parent topic: [Using the Interactive Features](#)

Sharing the Projected Screen

Follow the instructions in these sections to share the projected screen with other compatible projectors.

The screen sharing function is limited by the following:

- You can share the screen with projectors that support the screen sharing feature.
- If a firmware version amongst the projectors sharing the screen is not the same, you may need to update the projector's firmware to share your screen.
- You cannot share images or content that are protected by HDCP.
- You cannot change the projector's **Network** settings while screen sharing.

[Starting a Shared Screen Session](#)

Parent topic: [Using the Interactive Features](#)

Starting a Shared Screen Session

You can share the projector's screen with up to 4 compatible projectors on the same network. Users can interact with the shared screen from the connected projectors.

To use the Screen Sharing feature, the distributing and receiving projectors must be connected to the same network and have the **Screen Sharing** setting enabled in the projector's **Network** menu. Other requirements include the following:

- On the distributing projector: if you want to skip authentication of keywords for other projectors to speed up connection, set the **Connection Mode** setting to **Keyword Off** in the projector's **Network** menu.

1. Turn on the projector, if necessary.
2. Press the **Home** button on the remote control and select **Screen Sharing** on the Home screen.
3. Select the sharing option on the screen.
4. Enter the IP address of the projector you want to share your screen with and select **Connect**.

Note: You can also enter the projector keyword using the numeric keypad, if required, or select the IP address of a projector you have previously connected to from the connection history list. The projector keyword is displayed on the projected image of the receiving projector.

The projectors start connecting.

5. Enter the **Projector Keyword** if necessary.

When the connection is established, a connection status bar appears at the top of the distributing projector's screen. Each receiving projector displays a message indicating that it cannot share the image on the screen until the distributing projector selects an input source.

6. Repeat steps 4-5 to connect any remaining projectors.
7. Select the input source you want to display.

The projected screen is shared with the receiving projectors on their LAN input source.

8. To end screen sharing from the distributing projector, select the **Stop Sharing** icon in the status bar at the top of the screen.

Note: To end screen sharing from the receiving projectors, select the **Stop Sharing** icon on the toolbar.

You can also restrict drawing from receiving projectors. Press the **Home** button on the remote control and select **Screen Sharing**. In the list of connected projectors, tap the projector you wish to restrict drawing from and disable the drawing setting.

Parent topic: [Sharing the Projected Screen](#)

Using Interactive Features with Two Projectors (DuoLink)

You can use your projector's interactive features while projecting with two projectors installed side by side (BrightLink 1485Fi). If you're using a Mac, download and install the software from the website to get started.

See the online *Edge Blending Setup Guide* (available only in English) for additional information.

Parent topic: [Using the Interactive Features](#)

Adjusting the Menu Settings

Follow the instructions in these sections to access the projector menu system and change projector settings.

- Using the Projector's Menus
- Image Quality Settings - Image Menu
- Input Signal Settings - Signal I/O Menu
- Installation Settings - Installation Menu
- Display Settings - Display Menu
- Feature Settings - Operation Menu
- Administration Settings - Management Menu
- Network Settings - Network Menu
- Pen and Touch Setup Settings - Pen/Touch Menu
- Interactive Settings - Interactive Menu
- Multiple Projector Operation Settings - Multi-Projection Menu
- Image Quality Memory Settings - Memory Menu
- Setup Settings - ECO Menu
- Initial Settings and Reset Options - Initial/All Settings Menu

Using the Projector's Menus

You can use the projector's menus to adjust the settings that control how your projector works. The projector displays the menus on the screen.

1. Press the **Menu** button on the control panel or remote control.

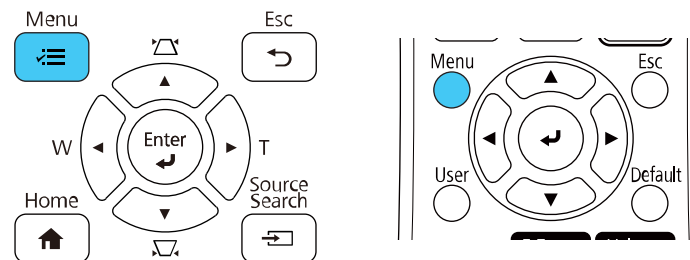

You see the menu screen.

Frequently Used Items	Image	
Image	Color Mode	Presentation
Signal I/O	Brightness	50
Installation	Contrast	50
Display	Color Saturation	50
Operation	Tint	50
Management	Sharpness	50
Network	White Balance	
Pen/Touch	Dynamic Contrast	Off
Interactive	Noise Reduction	0
Multi-Projection	MPEG Noise Reduction	Off
Memory	Gamma	0
ECO	RGBCMY	
Initial/All Settings	Deinterlacing	Off
	Super-resolution	
	Detail Enhancement	
	Reset to Defaults	
	Source	Computer1
	Resolution	Auto

2. Press the up or down arrow button to move through the menus listed on the left. The settings for each menu are displayed on the right.

Note: The available settings depend on the current input source, resolution, or other menu settings.

3. To change settings in the displayed menu, press **↵ Enter**.
4. Press the up or down arrow button to move through the settings.
5. Change the settings using the buttons listed on the bottom of the menu screens.
6. To return all the menu settings to their default values, select the **Initial/All Settings** menu.
7. When you finish changing settings on a menu, press **Esc**.
8. Press **Menu** or **Esc** to exit the menus.

Note: The  icon indicates that a setting contains sub-settings.

Note: You can also use the interactive pens or your finger to select menus and settings.

Parent topic: [Adjusting the Menu Settings](#)

Image Quality Settings - Image Menu

Settings on the Image menu let you adjust the quality of your image for the input source you are currently using. The available settings depend on the currently selected color mode and input source.

Frequently Used Items	Image	
Image	Color Mode	Presentation
Signal I/O	Brightness	50
Installation	Contrast	50
Display	Color Saturation	50
Operation	Tint	50
Management	Sharpness	50
Network	White Balance	
Pen/Touch	Dynamic Contrast	Off
Interactive	Noise Reduction	0
Multi-Projection	MPEG Noise Reduction	Off
Memory	Gamma	0
ECO	RGBCMY	
Initial/All Settings	Deinterlacing	Off
	Super-resolution	
	Detail Enhancement	
	Reset to Defaults	
	Source	Computer1
	Resolution	Auto

Color Mode Settings

Setting	Options	Description
Color Mode	See the list of available Color Modes	Adjusts the vividness of image colors for various image types and environments
Brightness	Varying levels available	Lightens or darkens the overall image
Contrast	Varying levels available	Adjusts the difference between light and dark areas of the image

Setting	Options	Description
Color Saturation	Varying levels available	Adjusts the intensity of the image colors
Tint	Varying levels available	Adjusts the balance of green to magenta tones in the image
Sharpness	Varying levels available	Adjusts the sharpness or softness of image details
White Balance	Color Temp. G-M Correction Custom	Sets the overall color tone of the image Color Temp.: sets the color temperature according to the selected color mode; lower values tint the image red, and higher values tint the image blue G-M Correction: makes fine adjustments to the color tone; higher values tint the image green and lower values tint the image red Custom: adjusts the individual RGB components of the offset and gain
Dynamic Contrast	Off Normal High Speed	Adjusts the projected luminance based on the image brightness

Setting	Options	Description
Image Enhancement	Image Preset Mode Noise Reduction MPEG Noise Reduction Deinterlacing Super-resolution Detail Enhancement Reset	Image Preset Mode: Saves the Image Enhancement settings as a preset Noise Reduction: Reduces flickering in analog images MPEG Noise Reduction: Reduces the noise or static in MPEG video Deinterlacing: Sets whether to convert interlaced-to-progressive signals for certain video image types Super-resolution: Sharpens blurred images when projecting low-resolution images Detail Enhancement: Enhances details to create clear outlines Reset: Resets all Image Enhancement settings to their default values
Gamma	-2 to 2 Custom	Adjusts the colors by selecting one of the gamma correction values or referring to a gamma graph
RGBCMY	Varying levels available	Adjusts the hue, saturation, and brightness for each color
Reset to Defaults	—	Resets all settings for the current input source
Reset Image Settings	—	Resets all Image menu settings to their default values

Note: The **Brightness** setting does not affect laser brightness. To change the laser brightness mode, use the **Light Source Brightness Control** setting in the Operation menu.

Input Source Settings

To change settings for an input source, make sure the source is connected and select that source.

Note: You can restore the default settings of the **Tracking**, **Sync**, and **Position** settings by pressing the **Auto** button on the remote control.

Setting	Options	Description
Source	—	Displays the current input source selected
Resolution	Auto Normal Wide	Sets the input signal resolution if not detected automatically using the Auto option
Aspect	See the list of available aspect ratios	Sets the aspect ratio (width-to-height ratio) Turn off the Scale setting or set the Scale Mode setting to Full Display before selecting this setting (BrightLink 1485Fi).
Scale (BrightLink 1485Fi)	Varying levels available	When using multiple projectors, adjusts the scale of the image displayed by each projector
Analog Signal Adjustment	Auto Setup Tracking Sync. Position	Adjusts the signal when Computer is the currently selected input source Auto Setup: set to On to automatically optimize the image quality Tracking: adjusts the signal to eliminate vertical stripes in images Sync: adjusts signal to eliminate fuzziness or flickering in images Position: adjusts the image location on the screen

Setting	Options	Description
Reset to Defaults	—	Resets all settings for the currently selected input source

Note: Select **Reset Image Settings** to reset all settings on the Image menu to their default values.

Parent topic: [Adjusting the Menu Settings](#)

Related concepts

[Image Aspect Ratio](#)

Related references

[Feature Settings - Operation Menu](#)

Related tasks

[Changing the Color Mode](#)

[Turning On Dynamic Contrast](#)

Input Signal Settings - Signal I/O Menu

Normally the projector detects and optimizes the input signal settings automatically. If you need to customize the settings, you can use the Signal I/O menu. The available settings depend on the currently selected input source.

Frequently Used Items	Signal I/O	
Image	Volume	
Signal I/O	Source	Computer 1
Installation	Signal Format	
Display	Mic Input Level	50
Operation	Overscan	Auto
Management	EDID	3240x1080/60Hz
	Reset to Defaults	
Network	A/V Output	While Projecting
Pen/Touch	Inverse Audio	Off
Interactive	Audio Output	Auto
Multi-Projection	HDMI Audio Output	
Memory	Monitor Out Port	Monitor Out
ECO	USB Display	0
Initial/All Settings	HDMI Link	
	Reset Signal I/O Settings	
	Installation	
	Fixed Installation	Off

To change settings for an input source, make sure the source is connected and select that source.

Setting	Options	Description
Volume	Varying levels available	Adjusts the volume of the projector's speaker system or external speakers

Setting	Options	Description
Source	Signal Format Mic Input Level Overscan EDID HDMI Out Intensity Reset to Defaults	<p>Signal Format: sets the signal type and video range for certain input sources</p> <ul style="list-style-type: none"> • Video Signal: specifies the signal type from video port input sources; if there is interference or no image when set to Auto, select the appropriate signal type • Video Range: sets the video range to match the setting of an HDMI or HDBaseT (BrightLink 1485Fi) input source <p>Mic Input Level: adjusts the microphone volume when audio is not output to an a/v system; when this setting is turned up, the other connected device's volume is turned down, and vice versa</p> <p>Overscan: changes the projected image ratio to make the edges visible by a set percentage or automatically when projecting a component signal</p> <p>EDID: describes the display capabilities of your projector when the selected input source is HDMI or HDBaseT (BrightLink 1485Fi); change this setting as necessary according to the current input source's resolution; you can adjust settings for individual input sources without changing the input source</p> <p>HDMI Out Intensity: adjusts the HDMI Out port's signal intensity input; change this setting when the image is not correctly displayed from the HDMI Out port</p> <p>Reset to Defaults: resets all settings for the current input source</p>

Setting	Options	Description
A/V Output	While Projecting Always On	Determines when the projector outputs audio and images to external devices; set to Always On to output audio and images when the projector is not projecting any images
Inverse Audio	On Off	Set to On to invert the audio's left and right channels to match the projector's installation position
Audio Output	Auto Audio Audio1 Audio2	Sets the audio input port when projecting from input sources other than HDMI, HDBaseT (BrightLink 1485Fi), LAN, and Screen Mirroring
HDMI Audio Output	HDMI1 HDMI2 HDMI3	Sets the audio input port when projecting from one of the HDMI ports
Monitor Out Port	Monitor Out Computer2	Selects the function of the Computer2/Monitor Out port Monitor Out: select this option when outputting an image signal to an external monitor Computer2: select this option when inputting an image signal from a computer
USB Display	On Off	Set to On to enable the USB Display feature for a computer connected to the USB-B1 port

Setting	Options	Description
HDMI Link	Device Connections HDMI Link Audio Out Device Power On Link Power Off Link	<p>Adjusts the HDMI Link options that allow the projector or remote to control HDMI-connected devices that support the CEC standard</p> <p>Device Connections: lists the devices connected to the HDMI1, HDMI2, and HDMI3 ports</p> <p>HDMI Link: enables or disables the HDMI Link feature</p> <p>Audio Out Device: selects whether to output audio from the internal speakers or a connected audio/visual system</p> <p>Power On Link: controls what happens when you turn on the projector or a linked device</p> <ul style="list-style-type: none"> • Bidirectional: automatically turns on the connected device when you turn on the projector, and vice versa • Device -> PJ: automatically turns on the projector when you turn on the connected device • PJ -> Device: automatically turns on the connected device when you turn on the projector <p>Power Off Link: controls whether linked devices are turned off when the projector is turned off</p>
HDMI EQ Setting	1 2 3	<p>HDMI EQ Setting: adjusts the HDMI input signal level depending on the devices connected to the HDMI port; change the setting if there is a lot of interference in the image or if a problem, such as no projected image, occurs (if no images are displayed using a thumb-sized media streaming device, select 1)</p>

Setting	Options	Description
Reset Signal I/O Settings	—	Resets all settings on the Signal I/O menu to their default values

Parent topic: [Adjusting the Menu Settings](#)

Installation Settings - Installation Menu

Settings on the Installation menu let you set up your projector for your installation environment. The available settings depend on the currently selected input source and other settings.

Frequently Used Items	Installation	
Image	Fixed Installation	Off
Signal I/O	Test Pattern	
Installation	Setting Plate Installation Guide	
Display	Vertical Installation	No
Operation	Projection	Front/UpSide Down
Management	Auto Screen Adjustment	
	Geometry Correction	Point Correction
Network	Digital Zoom ▼	
Pen/Touch	Connect ELPCB02	Off
Interactive	Touch Unit	
Multi-Projection	Remote Receiver	Off
Memory	Screen Type	16:9 ▼
ECO	High Altitude Mode	Off
Initial/All Settings	Reset Installation Settings	
	Display	
	Pattern Display	
	Pattern Type	

Setting	Options	Description
Fixed Installation	On Off	Set to On if you installed the projector in a fixed location
Test Pattern	—	Displays a test pattern to assist in focusing and zooming the image and correcting image shape

Setting	Options	Description
Setting Plate Installation Guide	—	Displays an on-screen guide to assist with installing the projection screen when you have installed the projector on a wall
Vertical Installation	Yes No	Set to Yes if you installed the projector in a vertical position
Projection	Front Rear Front/Upside Down Rear/Upside Down	Selects the way the projector faces the screen so the image is oriented correctly
Auto Screen Adjustment	—	Automatically adjusts the image shape when corner markers are placed on the projection surface

Setting	Options	Description
Geometry Correction	H/V-Keystone Quick Corner Arc Correction Point Correction Memory	<p>Adjusts image shape to rectangular (horizontally and vertically)</p> <p>H/V Keystone: lets you manually correct horizontal and vertical sides</p> <p>Quick Corner: select to correct image shape and alignment using an on-screen display</p> <p>Arc Correction: select to adjust the curve or arc of the horizontal and vertical sides</p> <p>Point Correction: select to divide the projected image into a grid and correct distortion by moving a selected point</p> <p>Memory: controls memory functions for current image shape settings</p> <ul style="list-style-type: none"> • Save Memory: saves the current image shape as a memory setting • Load Memory: loads a saved image shape memory • Rename Memory: renames a saved image shape memory • Erase Memory: deletes a saved image shape memory • Reset Memory: resets all the image shape memory settings
Digital Zoom	Varying levels available	Adjusts the size of the projected image

Setting	Options	Description
Image Shift	Varying positions available	Adjusts the position of the projected image
Connect ELPCB02	On Off	Set to On to switch the input source between the HDMI2 port and HDMI3 port each time you press the HDMI2 button on the optional interface box
Touch Unit	Installation Pattern Power Touch Unit Setup Touch Calibration Calibration Range	Installation Pattern: displays a pattern to help you adjust the position of the Touch Unit Power: turns on the Touch Unit power Touch Unit Setup: performs angle adjustment for laser diffusion Touch Calibration: performs calibration for finger touch operations Calibration Range: if finger touch operations are recognized as drag operations, select Wide to widen the calibration range
Remote Receiver	Front/Rear Front Rear Off	Limits reception of remote control signals by the selected receiver; Off turns off all receivers
Projector ID (BrightLink 1480Fi)	Off 1 through 9	Assigns an ID for the projector when you use multiple projectors

Setting	Options	Description
Screen Type	4:3 16:6 (BrightLink 1485Fi) 16:9 16:10 21:9	Sets the aspect ratio to fit the image on the projection surface
Screen Position	Varying positions available	Shifts the image position on the screen
High Altitude Mode	On Off	Regulates the projector's operating temperature at altitudes above 4921 feet (1500 m)
Reset Installation Settings	—	Resets all settings on the Installation menu to their default values except for the following: <ul style="list-style-type: none"> • Digital Zoom • Image Shift

Parent topic: [Adjusting the Menu Settings](#)

Related tasks

- [Correcting Image Shape with Arc Correction](#)
- [Correcting Image Shape with the Keystone Buttons](#)
- [Correcting Image Shape with Quick Corner](#)
- [Adjusting the Image Position](#)
- [Locking the Projector's Buttons](#)
- [Unlocking the Projector's Buttons](#)

Related topics

- [Setting Up the Projector](#)

Display Settings - Display Menu

Settings on the Display menu let you customize various projector display features. The available settings depend on the currently selected input source and other settings.

Frequently Used Items	Display	
Image	Pattern Display	
Signal I/O	Pattern Type	
Installation	No-signal Screen	Blue
Display	Startup Screen	On
Operation	Home Screen Auto Disp.	On
Management	Messages	On
Network	Menu Rotation	Off
Pen/Touch	Split Screen Setting	
Interactive	Reset Display Settings	
Multi-Projection	Operation	
Memory	Auto Source Search	On
ECO	Light Source Brightness Cont...	
Initial/All Settings	Direct Power On	Off
	Auto Power On	Off
	Sleep Mode	On
	Sleep Mode Timer	10 min.
	A/V Mute Timer	On

Setting	Options	Description
Pattern Display	—	Displays the selected pattern type to assist in adjusting the image
Pattern Type	Pattern 1 Pattern 2 Pattern 3 Pattern 4 User Pattern	Selects the type of grid pattern, line pattern, or custom pattern to display

Setting	Options	Description
No-signal Screen	Black Blue Logo Gradation	Select the screen color or logo to display when no input signal is detected
Startup Screen	On Off	Controls whether a logo is displayed when the projector starts up
Home Screen Auto Disp.	On Off	Controls whether the Home screen is displayed automatically when no input signal is detected when the projector turns on
Sort Source Thumbnails	On Off	Selects whether or not to sort sources on the Home screen by signal detection
Messages	On Off	Controls whether projector status and error messages are displayed on the projected image
Menu Rotation	Right 90 Degree Left 90 Degree Off	Rotates the menu display 90°
Menu Color	Black White	Sets the color theme of the Home screen and projector menus

Setting	Options	Description
Split Screen Setting	Display Audio Output Source Align	Adjusts the Split Screen feature Display Audio Output Source: controls whether an icon is displayed with the source providing audio output during Split Screen projection Align: if splitting the screen between two images, determines whether the images are aligned at the top or in the middle of the screen
Reset Display Settings	—	Resets all settings on the Display menu to their default values

Note: You must disable User's Logo password protection to adjust the **No-signal Screen** and **Startup Screen** settings.

Parent topic: [Adjusting the Menu Settings](#)

Related tasks

[Creating a User Pattern to Display](#)

Feature Settings - Operation Menu

Settings on the Operation menu let you customize various projector features that control its operation. The available settings depend on the currently selected input source and other settings.

Frequently Used Items	Operation	
Image	Auto Source Search	On
Signal I/O	Light Source Brightness Cont...	
Installation	Direct Power On	Off
Display	Auto Power On	Off
Operation	Sleep Mode	On ^
Management	Sleep Mode Timer	10 min.
Network	A/V Mute Timer	On
Pen/Touch	Standby Mode	Communication On ^
Interactive	Port	Wired LAN
Multi-Projection	Quick Startup	Off
Memory	Indicators	On
ECO	Inv Direction Button	Off
Initial/All Settings	Reset Operation Settings	
	Management	
	User Button	Light Source Mode
	User's Logo	
	User Pattern	

Setting	Options	Description
Auto Source Search	On Off	Enables the projector to automatically select an input source

Setting	Options	Description
Light Source Brightness Control	Maintain Brightness Maintain Brightness Level Estimated Remains Light Source Mode Brightness Level	<p>Controls the constant brightness of the projector's light source</p> <p>Maintain Brightness: maintains a constant brightness</p> <p>Maintain Brightness Level: selects the brightness level to maintain when the Maintain Brightness setting is enabled</p> <p>Estimated Remains: if the Maintain Brightness setting is enabled, displays the remaining number of hours the projector can maintain constant brightness</p> <p>Light Source Mode: selects the brightness mode of the projector when the Maintain Brightness setting is disabled</p> <ul style="list-style-type: none"> • Normal: maximum brightness • Quiet: 70% brightness with reduced fan noise • Extended: 70% brightness and extends the life expectancy of the light source • Custom: select a custom brightness level and enable use of the next setting <p>Brightness Level: select the Custom brightness level you want</p>
Direct Power On	On Off	<p>Controls whether the projector automatically turns on when you plug it in</p>

Setting	Options	Description
Auto Power On	HDMI1 Computer1 USB Display Off	Selects whether to automatically turn on the projector when you connect an input signal to a specific input source If you select HDMI1 , set the method for automatically turning on the projector in the Power On Trigger setting.
Power On Trigger	Plug-in Detection Signal Detection	Sets the way the projector turns on when Auto Power On is set to HDMI1 . Plug-in Detection: automatically turns the projector on when it detects a connected device is turned on Signal Detection: automatically turns the projector on when an HDMI signal is detected Note: When Signal Detection is selected, the power used in standby mode increases.
Sleep Mode	On Off	Automatically turns off the projector after an interval of inactivity
Sleep Mode Timer	1 to 30 minutes	Sets the time before the projector automatically turns off (Sleep Mode must be turned on)
A/V Mute Timer	On Off	Automatically turns off the projector after 30 minutes of inactivity

Setting	Options	Description
Standby Mode	Communication On Communication Off	Enable this setting to allow the following operations to occur when the projector is in standby mode: <ul style="list-style-type: none"> • Monitor and control the projector over a network • Output audio and video to an external device (A/V Output must be set to Always On)
Port	Wired LAN Wireless LAN	Selects the port to use while the Standby Mode setting is set to Communication On
Quick Startup	20min. 60min. 90min. Off	Sets the time period for which you want to be able to restart the projector within five seconds of turning it off (Quick Start mode). Make sure to first set A/V Output to While Projecting , Auto Power On to Off , and Power On Trigger to Plug-in Detection . It may take longer than five seconds when projecting from the projector's USB or HDMI Out ports, when using the Screen Mirroring features, if whiteboard sharing was ended in the previous session, or if you want to restore the whiteboard contents from the previous session.
Closed Caption	CC1 CC2 Off	Enables and selects the type of closed captions to display
Indicators	On Off	Enables or disables the status indicator lights on the projector

Setting	Options	Description
Inv Direction Button	On Off	Enable this setting if you want to invert the direction of the arrow buttons on the control panel to match the projector's installation position
Reset Operation Settings	—	Reset all settings on the Operation menu to their default values

Parent topic: [Adjusting the Menu Settings](#)

Related tasks

[Turning On the Projector](#)

[Turning Off the Projector](#)

[Selecting a Quick Startup Setting](#)

Administration Settings - Management Menu

Settings on the Management menu let you customize various projector administrative features.

Frequently Used Items	Management	
Image	User Button	Light Source Mode
Signal I/O	User's Logo	
Installation	User Pattern	
Display	Control Panel Lock	Off
Operation	Color Uniformity	
Management	Refresh Mode	
Network	Light Source Calibration	
Pen/Touch	Date & Time	
Interactive	Schedule Settings	
Multi-Projection	Wireless LAN Power	
Memory	Wireless LAN Diagnosis	1
ECO	Log Save Destination	USB and Internal Memory
Initial/All Settings	Batch Setup Range	
	Language	English
	Information	
	Display Logs	
	Reset Management Settings	
	Network	

Note: You must disable Schedule password protection to adjust the **Schedule Settings** settings.

Setting	Options	Description
User Button	Light Source Mode Information Deinterlacing Closed Caption Resolution Mic Input Level Pattern Display Auto Calibration Display LAN Info. Setting Plate Installation Guide	Assigns a menu option to the User button on the remote control for one-touch access (Auto Calibration is the default option)
User's Logo	Start Setting Reset	Creates the screen that the projector displays to identify itself and enhance security
User Pattern	—	Captures a projected screen and saves it as a pattern for display; select Pattern Display in the Display menu to display the saved pattern
Control Panel Lock	Full Lock Except for Power Off	Controls projector button locking to secure the projector Full Lock: locks all buttons Except for Power: locks all buttons except the power button Off: no buttons locked

Setting	Options	Description
Color Uniformity	Color Uniformity Adjustment Level Start Adjustments Reset	Adjusts the color tone balance Color Uniformity: set to On to adjust the color tone balance for the whole screen Adjustment Level: sets the adjustment level Start Adjustments: adjusts the red, green, and blue color tones individually for the selected area Reset: resets all Color Uniformity adjustment values to their defaults
Color Matching (BrightLink 1480Fi)	Adjustment Level Red Green Blue Brightness	Corrects the tint and brightness differences between images
Refresh Mode	Timer Messages Start	Select Start to clear an afterimage that remains in the projected image and turn off the projector after the time specified in the Timer screen. Press any button to cancel Refresh Mode. Enable the Messages setting if you want to display a message when Refresh Mode is in progress.

Setting	Options	Description
Light Source Calibration	Run Now Run Periodically Last Run	Selects options to perform light source calibration to maintain the color balance of the projected image Run Now: Select On to start light source calibration now. Make sure the projector has been turned on for at least 30 minutes for maximum accuracy. You may not be able to start calibration if the projector's environmental temperature is out of range. Run Periodically: Select On to perform calibration every 100 hours of usage Last Run: Displays the date and time light source calibration was last performed
Date & Time	Date & Time Daylight Saving Time Internet Time	Adjusts the projector's date and time settings <ul style="list-style-type: none"> • Date & Time: sets the date and time on the projector • Daylight Saving Time: enables daylight saving time • Internet Time: updates the time automatically via an online time server
Schedule Settings	—	Schedules projector events to occur automatically at selected dates and times
Wireless LAN Power	On Off	Enables or disables wireless communication

Setting	Options	Description
Wireless LAN Diagnosis	Output Ping IP Address Ping until stopped Start	Displays the status of the wireless LAN communication
Log Save Destination	Internal Memory USB and Internal Memory	Selects where you want to save projector error and operation log files
Batch Setup Range	All Limited	Selects which projector menu settings to copy using the batch setup feature; select All to copy all the settings, or select Limited to copy all settings except for the following: <ul style="list-style-type: none"> • Password Protection settings • EDID setting in the Signal I/O menu • Network menu settings
Language	Various languages available	Selects the language for projector menu and message displays

Setting	Options	Description
Information	Operation Hours Light Source Hours Estimated Remains Source Input Signal Resolution Refresh Rate Sync Info Video Signal HDBaseT Signal Level (BrightLink 1485Fi) Status Serial Number Event ID Version	Displays information about the projector and current input signal; the displayed items vary depending on the current input source The Version option displays version numbers for the projector and other components
Display Logs	Temp Warning Info Power On/Off History	Displays log data saved to the location specified in the Log Save Destination setting
Reset Management Settings	—	Resets all settings on the Management menu to their default values except for the following: <ul style="list-style-type: none"> • Schedule Settings • Language

[Event ID Code List](#)

Parent topic: [Adjusting the Menu Settings](#)

Related tasks

[Setting the Date and Time](#)

[Selecting the Language for the Projector Menus](#)

- [Saving a Scheduled Event](#)
- [Viewing Scheduled Events](#)
- [Editing a Scheduled Event](#)

Event ID Code List

If the **Event ID** option on the Information screen in the Management menu displays a code number, check this list of Event ID codes for the solution to the projector problem associated with the code.

Event ID code	Cause and solution
0026	A screen mirroring communication error has occurred. Turn the projector off and on again, or restart the network software.
0032	
0036	
0037	
0027	Unstable screen mirroring communication. Check the network communication status, wait a few moments, and try connecting to the network again.
0028	
0029	
0030	
0031	
0035	
0023	Connection failed. If you see the PIN entry screen on your computer, enter the PIN code displayed on the network information screen or at the bottom right of the projected image. If this does not solve the problem, restart the projector and the connected devices, and then check the connection settings.
0024	
0025	
0043	The video format is not supported. Change the resolution of the mobile device and reconnect. Alternatively, change the Adjust Image Quality setting for the projector and reconnect.
0432	The network software did not start. Turn the projector off and then on again.
0435	
0433	Cannot display the transferred images. Restart the network software.

Event ID code	Cause and solution
0434	Unstable network communication. Check the network communication status, wait a few moments, and try connecting to the network again.
0481	
0482	
0485	
0483	The network software quit unexpectedly. Check the network communication status, then turn the projector off and then on again.
04FE	
0484	Communication with computer was disconnected. Restart the network software.
0479	A projector system error has occurred. Turn the projector off and then on again.
04FF	
0891	Cannot find the SSID (network name). Make sure your computer and projector are connected to your access point's current SSID.
0892	The WPA/WPA2/WPA3 authentication type does not match. Make sure the wireless network security settings are correct.
0893	The WEP/TKIP/AES encryption type does not match. Make sure the wireless network security settings are correct.
0894	Communication with unauthorized access point was disconnected. Contact your network administrator.
0895	Communication with a connected device was disconnected. Check your device's connection status.
0898	Failed to acquire DHCP address. Make sure the DHCP server is operating correctly. If you are not using DHCP, turn off the DHCP setting in the Network menus.
0899	A communication error has occurred. Try restarting the network software and restarting your projector. If that does not solve the problem, contact Epson for help.
089A	The EAP authentication type does not match the network. Check the wireless LAN security settings and make sure that the security certificate is installed correctly.
089B	EAP server authentication failed. Check the wireless LAN security settings and make sure that the security certificate is installed correctly.
089C	EAP client authentication failed. Check the wireless LAN security settings and make sure that the security certificate is installed correctly.

Event ID code	Cause and solution
089D	Key exchange failed. Check the wireless LAN security settings and make sure that the security certificate is installed correctly.
0920	The internal battery that saves the projector's date and time settings is running low. Contact Epson for help.
0B01	The internal storage could not be detected correctly. Turn off the projector and disconnect the power cord, then reconnect the power cord and turn the projector back on. When the projector is turned on, the security certificate and address book are deleted. If that does not solve the problem, contact Epson for help.
0BFF	An error has occurred in the whiteboard function. Restart the projector.

Parent topic: [Administration Settings - Management Menu](#)

Related references

[Network Settings - Network Menu](#)

Related tasks

[Setting Up Wireless Network Security](#)

Network Settings - Network Menu

Settings on the Network menu let you view network information and set up the projector for control over a network.

Frequently Used Items	Network
Image	Wireless LAN Info.
Signal I/O	Wireless LAN Info. IPv6
Installation	Simple AP
Display	Wired LAN Info.
Operation	Wired LAN Info. IPv6
Management	Network Settings
	Reset Network Settings
Network	
Pen/Touch	Pen/Touch
Interactive	Auto Calibration
Multi-Projection	Manual Calibration
Memory	Touch Unit
ECO	Installation of Projectors
Initial/All Settings	Pen Hovering On
	PC Interactivity
	Reset Pen/Touch Settings
	Interactive
	Drawing Function On

Note: You must disable Network password protection to adjust the network settings.

Setting	Options	Description
Wireless LAN Info.	Projector Name Wireless LAN	Displays wireless network status and details when the wireless LAN module is installed or when the Simple AP setting is disabled The Wireless LAN option displays the following: <ul style="list-style-type: none"> • Antenna level • SSID • Channel • DHCP • IP Address • Subnet Mask • Gateway Address • DNS Server 1 • DNS Server 2 • MAC Address • Region Code
Wired LAN Info.	Projector Name DHCP IP Address Subnet Mask Gateway Address MAC Address	Displays wired network status and details

Setting	Options	Description
Wired LAN Info. IPv6	IPv6 Address (Manual) IPv6 Address (Auto)	Displays IPv6 information. The IPv6 Address (Manual) option displays the following: <ul style="list-style-type: none"> • IPv6 Address • Prefix Length • Gateway Address The IPv6 Address (Auto) option displays the following: <ul style="list-style-type: none"> • Temporary Address • Link-local Address • Stateless Address • Stateful Address
Network Settings	—	Configures your network settings
Reset Network Settings	—	Resets all settings on the Network menu to their default values

Parent topic: [Adjusting the Menu Settings](#)

Related concepts

[Wireless Network Projection](#)

[Wired Network Projection](#)

Related references

[Wireless LAN Menu Settings](#)

Pen and Touch Setup Settings - Pen/Touch Menu

Settings on the Pen/Touch menu let you set up the interactive pens and finger touch operations.

Frequently Used Items	Pen/Touch
Image	Auto Calibration
Signal I/O	Manual Calibration
Installation	Touch Unit
Display	Installation of Projectors
Operation	Pen Hovering On
Management	PC Interactivity
Network	Reset Pen/Touch Settings
Pen/Touch	Interactive
Interactive	Drawing Function On
Multi-Projection	Display Toolbars Always Show
Memory	Display Drawing Area
ECO	Confirm Clear Screen On
Initial/All Settings	Pen Button Function Eraser
	Display Clock Date & Time ^
	Date YYYY-MM-DD
	Time HH:MM
	Print

Setting	Options	Description
Auto Calibration	—	Start calibration for the interactive pens
Manual Calibration		

Setting	Options	Description
Touch Unit	Power Touch Unit Setup Touch Unit Adjustment Guide Touch Calibration Calibration Range	Select settings for the Touch Unit Power: turns on the Touch Unit power Touch Unit Setup: performs angle adjustment for laser diffusion Touch Unit Adjustment Guide (BrightLink 1485Fi): when using multiple projectors side by side, displays a guide for adjusting the adjacent projector's settings for use with the touch unit (HDMI Out Setting must be set to Process Out) Touch Calibration: performs calibration for finger touch operations Calibration Range: if finger touch operations are recognized as drag operations, select Wide to widen the calibration range
Installation of Projectors	Infrared Intensity Sync of Projectors	Select settings for interactive pen and finger touch operations with multiple projectors Infrared Intensity: if the interactive pens are unstable due to infrared interference, select Strong Sync of Projectors: if the projectors are connected using the optional remote control cable set, select Wired

Setting	Options	Description
Pen Hovering	On Off	Turns the pen hovering feature on and off; when set to On , the pointer follows the pen tip as you hover it over the screen and move it around
PC Interactivity	Pen Tracking Mode Press and Hold Pen Tip Behavior USB-B2 Auto Adjust Pen Area Manual Adj. Pen Area	<p>Select pen operation and adjustment options</p> <p>Pen Tracking Mode: sets the correct operating system for the interactive pen features. For Windows or Mac, select Pen Mode. For Ubuntu, select Mouse Mode.</p> <p>Press and Hold: when set to Right Click, lets you use a long pen press or finger press as a right-click operation</p> <p>Pen Tip Behavior: assigns either Right Click or Left Click to the pen tip</p> <p>USB-B2: sets the HDMI port used for the computer connected to the USB-B2 when using interactive features with the computer</p> <p>Auto Adjust Pen Area: automatically adjusts the pen area as the resolution for the connected computer image changes</p> <p>Manual Adj. Pen Area: lets you adjust the pen area manually (only displayed when PC Interactivity is enabled)</p>

Setting	Options	Description
Reset Pen/Touch Settings	—	Resets all settings on the Pen/Touch menu to their default values

Parent topic: [Adjusting the Menu Settings](#)

Related concepts

[Pen Calibration](#)

Related tasks

[Calibrating for Finger Touch Interactivity](#)

Related topics

[Using the Interactive Features](#)

Interactive Settings - Interactive Menu

Settings on the Interactive menu let you customize various projector interactive features.

Frequently Used Items	Interactive
Image	Drawing Function On
Signal I/O	Display Toolbars Always Show
Installation	Display Drawing Area
Display	Confirm Clear Screen On
Operation	Pen Button Function Eraser
Management	Display Clock Date & Time ^
Network	Date YYYY-MM-DD
Pen/Touch	Time HH:MM
Interactive	Print
Multi-Projection	Save
Memory	Mail
ECO	Directory
Initial/All Settings	Reset Interactive Settings
	Multi-Projection
	Projector ID Off
	HDMI Out Setting Off v
	Geometry Correction Point Correction

Note: You must disable Interactive password protection to adjust the interactive settings.

Setting	Options	Description
Drawing Function	On Off	Enables or disables features for drawing on the projected image
Display Toolbars	Always Show Hide for Set Time	Controls when the interactive toolbar is displayed
Toolbar Color	Black White	Sets the interactive toolbar color
Display Drawing Area	On Off	Displays or hides the drawing area
Confirm Clear Screen	On Off	Displays a confirmation screen before clearing all content drawn on the projected image
Pen Button Function	Drawing Toolbar Eraser Clear Screen Off	Sets the function of the button on the side of the interactive pens
Display Clock	Date&Time Date Time Off	Sets the date and time display on the whiteboard toolbar; adjust the Date & Time setting in the Management menu
Date	YYYY-MM-DD YYYY/MM/DD MM/DD/YYYY DD/MM/YYYY	Sets the format of the date
Print	—	Adjusts settings that control whiteboard printing

Setting	Options	Description
Save	—	Adjusts settings that control file saving of whiteboard content
Mail	—	Adjusts settings that control email transmission of whiteboard content
Directory	—	Adjusts settings that control directory services to search for email addresses
Reset Interactive Settings	—	Resets all settings on the Interactive menu to their default values

Parent topic: [Adjusting the Menu Settings](#)

Related tasks

[Saving Pages in Whiteboard Mode](#)

[Printing Whiteboard Pages](#)

[Emailing Whiteboard Pages](#)

[Using the Pens](#)

[Creating an Address Book](#)

Related topics

[Using the Interactive Features](#)

Multiple Projector Operation Settings - Multi-Projection Menu

Settings on the Multi-Projection menu let you set up multiple projectors to project a single unified image (BrightLink 1485Fi).

Frequently Used Items	Multi-Projection
Image	Projector ID Off
Signal I/O	HDMI Out Setting Off ▼
Installation	Geometry Correction Point Correction
Display	Edge Blending
Operation	Scale
Management	Color Uniformity
Network	Light Source Mode Normal
Pen/Touch	Color Matching
Interactive	RGBCMY
	Reset Multi-Projection Settings
Multi-Projection	Memory
Memory	Save Memory
ECO	Load Memory
Initial/All Settings	Rename Memory
	Erase Memory
	Reset Memory
	ECO

Setting	Options	Description
Projector ID	Off 1 through 9	Assigns an ID for the projector when you use multiple projectors
HDMI Out Setting	Pass Through Process Out Off	Set to Pass Through to enable up to four projectors connected via HDMI cables to project a unified image. Set to Process Out to enable use of interactive pens or finger touch operations for up to two projectors.

Setting	Options	Description
Number of Projectors	2 to 4	Sets the number of projectors used to create a unified image; this setting is displayed only if HDMI Out Setting is set to Pass Through
Order	1 to 4 (when HDMI Out Setting is set to Pass Through) 1 or 2 (when HDMI Out Setting is set to Process Out)	Sets the projector's position in numbered order from left to right
Connect Computer	Yes No	Set to Yes if you connected a computer to the projector; this setting is displayed only if HDMI Out Setting is set to Process Out

Setting	Options	Description
Geometry Correction	H/V-Keystone Quick Corner Arc Correction Point Correction Memory	<p>Adjusts image shape to rectangular (horizontally and vertically)</p> <p>H/V Keystone: lets you manually correct horizontal and vertical sides</p> <p>Quick Corner: select to correct image shape and alignment using an on-screen display</p> <p>Arc Correction: select to adjust the curve or arc of the horizontal and vertical sides</p> <p>Point Correction: select to divide the projected image into a grid and correct distortion by moving a selected point</p> <p>Memory: controls memory functions for current image shape settings</p> <ul style="list-style-type: none"> • Save Memory: saves the current image shape as a memory setting • Load Memory: loads a saved image shape memory • Rename Memory: renames a saved image shape memory • Erase Memory: deletes a saved image shape memory • Reset Memory: resets all the image shape memory settings

Setting	Options	Description
Edge Blending	Edge Blending Top Edge Bottom Edge Left Edge Right Edge Line Guide Pattern Guide Guide Color	Blends the border between multiple images to create a seamless screen
Black Level	Color Adjustment Area Correction Reset	Adjusts the brightness and tone differences in overlapping images
Scale	Varying levels available	When using multiple projectors, adjusts the scale of the image displayed by each projector
Color Uniformity	Color Uniformity Adjustment Level Start Adjustments Reset	Adjusts the color tone balance Color Uniformity: set to On to adjust the color tone balance for the whole screen Adjustment Level: sets the adjustment level Start Adjustments: adjusts the red, green, and blue color tones individually for the selected area Reset: resets all Color Uniformity adjustment values to their defaults

Setting	Options	Description
Light Source Mode	Normal Quiet Extended Custom	Selects the brightness mode of the projector when the Maintain Brightness setting is disabled Normal: maximum brightness Quiet: 70% brightness with reduced fan noise Extended: 70% brightness and extends the life expectancy of the light source Custom: select a custom brightness level and enable use of the next setting
Color Matching	Adjustment Level Red Green Blue Brightness	Corrects the tint and brightness differences between images
RGBCMY	Varying levels available	Adjusts the hue, saturation, and brightness for each color
Reset Multi-Projection Settings	—	Resets all settings on the Multi-Projection menu to their default values

Parent topic: [Adjusting the Menu Settings](#)

Related concepts

[Using Multiple Projectors \(DuoLink\)](#)

Related references

[Multiple Projector Connection Menu Settings](#)

Related tasks

[Blending the Image Edges](#)

[Adjusting Color Uniformity](#)

- Matching the Image Colors
- Adjusting the Black Level
- Adjusting RGBCMY
- Scaling an Image

Image Quality Memory Settings - Memory Menu

Settings on the Memory menu let you save and load image quality settings in the projector's memory.

Frequently Used Items	Scale
Image	Color Uniformity
Signal I/O	Light Source Mode Normal
Installation	Color Matching
Display	RGBCMY
Operation	Reset Multi-Projection Settings
Management	Memory
Network	Save Memory
Pen/Touch	Load Memory
Interactive	Rename Memory
Multi-Projection	Erase Memory
	Reset Memory
Memory	ECO
ECO	Light Source Mode Normal
Initial/All Settings	Sleep Mode On
	Standby Mode Communication On
	Initial/All Settings
	Reset All

Setting	Options	Description
Save Memory	Memory 1 to 10	Lets you save the current image quality settings to memory
Load Memory	Memory 1 to 10	Loads a saved image quality setting memory
Rename Memory	Memory 1 to 10	Renames a saved image quality setting memory

Setting	Options	Description
Erase Memory	Memory 1 to 10	Deletes a saved image quality setting memory
Reset Memory	—	Resets all the image quality setting memory settings

Parent topic: [Adjusting the Menu Settings](#)

Related tasks

[Saving Settings to Memory and Using Saved Settings](#)

Setup Settings - ECO Menu

Settings on the ECO menu let you customize projector functions to save power.

Frequently Used Items	Scale	
Image	Color Uniformity	
Signal I/O	Light Source Mode	Normal
Installation	Color Matching	
Display	RGBCMY	
Operation	Reset Multi-Projection Settings	
Management	Memory	
Network	Save Memory	
Pen/Touch	Load Memory	
Interactive	Rename Memory	
Multi-Projection	Erase Memory	
Memory	Reset Memory	
ECO	ECO	
	Light Source Mode	Normal
Initial/All Settings	Sleep Mode	On
	Standby Mode	Communication On
	Initial/All Settings	
	Reset All	

Setting	Options	Description
Light Source Mode	Normal Quiet Extended Custom	Selects the brightness mode of the projector when the Maintain Brightness setting is disabled Normal : maximum brightness Quiet : 70% brightness with reduced fan noise Extended : 70% brightness and extends the life expectancy of the light source Custom : select a custom brightness level and enable use of the next setting
Sleep Mode	On Off	Automatically turns off the projector after an interval of inactivity
Sleep Mode Timer	1 to 30 minutes	Sets the interval for Sleep mode
A/V Mute Timer	On Off	Automatically turns off the projector after 30 minutes if A/V Mute is enabled
Standby Mode	Communication On Communication Off	Enable this setting to allow the following operations to occur when the projector is in standby mode: <ul style="list-style-type: none"> • Monitor and control the projector over a network • Output audio and video to an external device (A/V Output must be set to Always On)

Parent topic: [Adjusting the Menu Settings](#)

Related references

[Projector Light Source Specifications](#)

Initial Settings and Reset Options - Initial/All Settings Menu

You can reset most of the projector settings to their default values using the **Reset All** option on the Initial/All Settings menu.

Frequently Used Items	Scale
Image	Color Uniformity
Signal I/O	Light Source Mode Normal
Installation	Color Matching
Display	RGBCMY
Operation	Reset Multi-Projection Settings
Management	Memory
Network	Save Memory
Pen/Touch	Load Memory
Interactive	Rename Memory
Multi-Projection	Erase Memory
Memory	Reset Memory
ECO	ECO
Initial/All Settings	Light Source Mode Normal
	Sleep Mode On
	Standby Mode Communication On
	Initial/All Settings
	Reset All

When you select the **Reset All** option, you see this screen:

[Reset All]		Return
<input checked="" type="checkbox"/> Reset Image Settings	<input checked="" type="checkbox"/> Reset Network Settings	
<input checked="" type="checkbox"/> Reset Signal I/O Settings	<input checked="" type="checkbox"/> Reset Pen/Touch Settings	
<input checked="" type="checkbox"/> Reset Installation Settings	<input checked="" type="checkbox"/> Reset Interactive Settings	
<input checked="" type="checkbox"/> Reset Display Settings	<input checked="" type="checkbox"/> Reset Multi-Projection Settings	
<input checked="" type="checkbox"/> Reset Operation Settings	<input checked="" type="checkbox"/> Reset Memory	
<input checked="" type="checkbox"/> Reset Management Settings		
	Execute	

Checkmarks appear next to the menu settings that are selected to be reset. If you do not want to reset settings in some menus, deselect them. When you are ready, select **Execute** and press **↵ Enter**.

You cannot reset the following settings using the **Reset All** option:

- Digital Zoom
- Image Shift
- Schedule Settings
- User Pattern
- Language

Note: The Network and Interactive menu settings do not reset if **Menu Protection** is enabled.

Parent topic: [Adjusting the Menu Settings](#)

Maintaining and Transporting the Projector

Follow the instructions in these sections to maintain your projector and transport it from place to place.

[Projector Maintenance](#)

[Air Filter and Vent Maintenance](#)

[Replacing the Remote Control Batteries](#)

[Replacing the Hard Pen Tips](#)

[Replacing the Soft Pen Tips](#)

[Updating the Firmware](#)

[Transporting the Projector](#)

Projector Maintenance

Your projector needs little maintenance to keep working at its best.

You may need to clean the lens periodically, and clean the air filter and air vents to prevent the projector from overheating due to blocked ventilation.

The only parts you should replace are the air filter, pen batteries and tips, and remote control batteries. If any other part needs replacing, contact Epson or an authorized Epson servicer.

This projector uses a sealed laser light source which does not need servicing and cannot be replaced.

Warning: Before cleaning any part of the projector, turn it off and unplug the power cord. Never open any cover on the projector, except as specifically explained in this manual. Dangerous electrical voltages in the projector can injure you severely.

Warning: Do not try to service this product yourself, except as specifically explained in this manual. Refer all other servicing to qualified servicers.

[Cleaning the Lens](#)

[Cleaning the Projector Case](#)

Parent topic: [Maintaining and Transporting the Projector](#)

Cleaning the Lens

Clean the projector's lens periodically, or whenever you notice dust or smudges on the surface. Make sure you unplug the projector before cleaning the lens.

- To remove dust or smudges, gently wipe the lens with lens-cleaning paper.
- To remove stubborn smudges, moisten a soft, lint-free cloth with lens cleaner and gently wipe the lens. Do not spray any liquid directly on the lens.

Warning: Do not use a lens cleaner that contains flammable gas. The high heat generated by the projector may cause a fire.

Caution: Do not use glass cleaner or any harsh materials to clean the lens and do not subject the lens to any impacts; you may damage it. Do not use canned air, or the gases may leave a residue. Avoid touching the lens with your bare hands to prevent fingerprints on or damage to the lens surface.

Parent topic: [Projector Maintenance](#)

Related tasks

[Turning Off the Projector](#)

Cleaning the Projector Case

Before cleaning the projector case, turn off the projector and unplug the power cord.

- To remove dust or dirt, use a soft, dry, lint-free cloth.
- To remove stubborn dirt, use a soft cloth moistened with water and mild soap. Do not spray liquid directly on the projector.

Caution: Do not use wax, alcohol, benzene, paint thinner, or other chemicals to clean the projector case. These can damage the case. Do not use canned air, or the gases may leave a flammable residue.

Parent topic: [Projector Maintenance](#)

Related tasks

[Turning Off the Projector](#)

Air Filter and Vent Maintenance

Regular filter maintenance is important to maintaining your projector. Your Epson projector is designed with an easily accessible, user-replaceable filter to protect your projector and make regular maintenance simple. Filter maintenance intervals will depend on the environment.

If regular maintenance is not performed, your Epson projector will notify you when the temperature inside the projector has reached a high level. Do not wait until this warning appears to maintain your projector filter as prolonged exposure to high temperatures may reduce the life of your projector or laser.

Damage due to the failure to properly maintain the projector or its filter may not be covered by the projector's Limited Warranty.

[Cleaning the Air Filter and Vents](#)

[Replacing the Air Filter](#)

Parent topic: [Maintaining and Transporting the Projector](#)

Related references

[Projector Light Source Specifications](#)

Cleaning the Air Filter and Vents

Clean the projector's air filter or vents if they get dusty, or if you see a message telling you to clean them.

Caution: Do not use water or any detergent to clean the air filter. Do not use canned air, or the gases may leave a flammable residue.

1. Turn off the projector and unplug the power cord.
2. Loosen the screws securing the air filter cover.

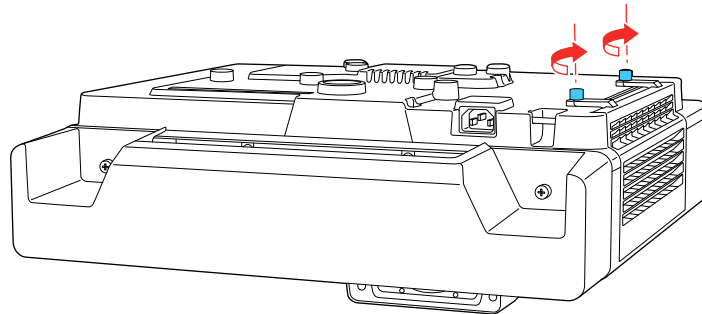

3. Open the air filter cover.

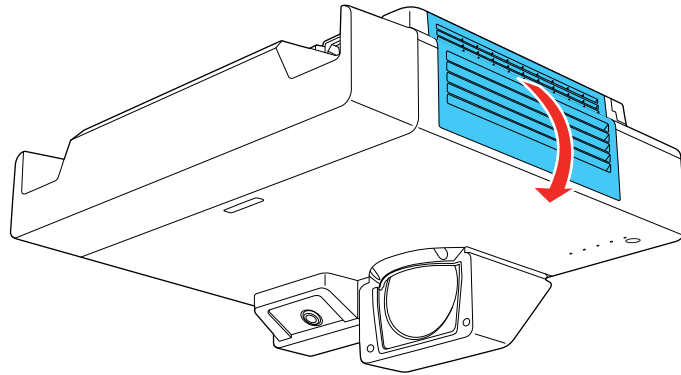

4. Pull the air filter out of the projector.

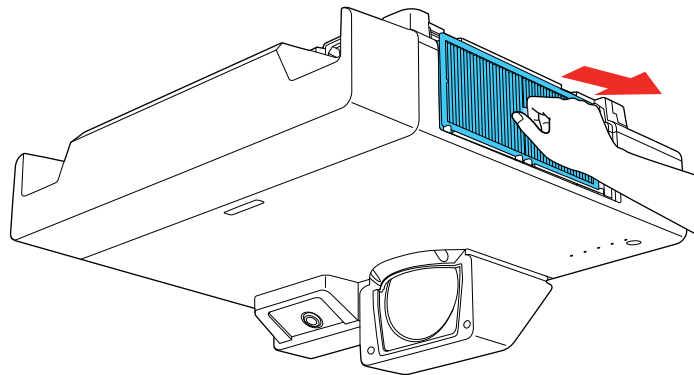

5. Tap each side of the filter 4 to 5 times to shake off any excess dust. Do this outside the room or away from the projector.

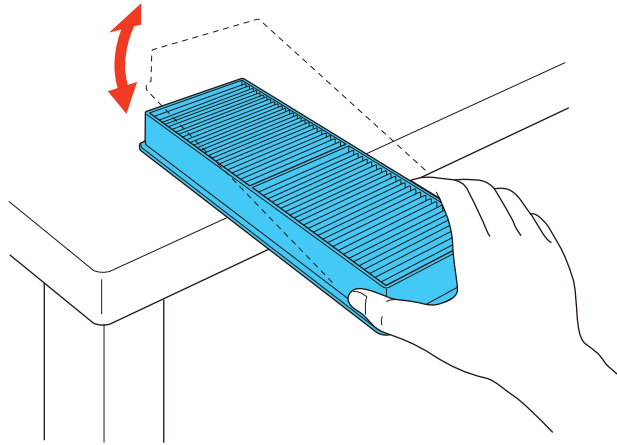

Caution: Do not use excessive force when tapping the air filter, or it may crack and become unusable. Do not rinse the air filter in water, or use any detergent or solvent to clean it. Do not use canned air; the gases may leave a flammable residue, or push dust and debris into the projector's optics or other sensitive areas.

6. Vacuum the front of the air filter (the side with the tabs) to remove any remaining dust.

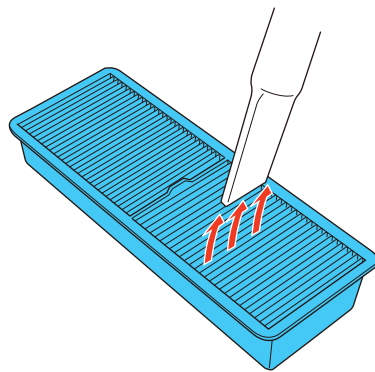

Note: If dust is difficult to remove or the air filter is damaged, replace the air filter.

7. Place the air filter back in the projector as shown.

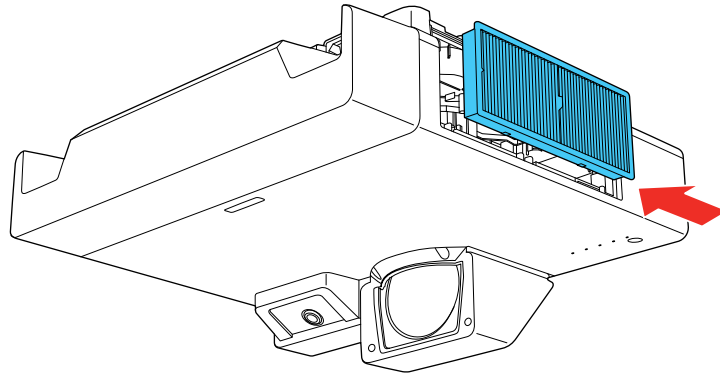

8. Close the air filter cover and tighten the screws.

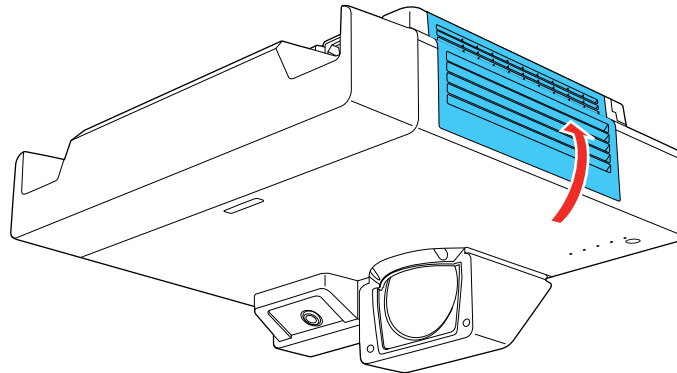

Parent topic: [Air Filter and Vent Maintenance](#)

Related tasks

[Turning Off the Projector](#)

Replacing the Air Filter

You need to replace the air filter in the following situations:

- After cleaning the air filter, you see a message telling you to clean or replace it
- The air filter is torn or damaged

You can replace the air filter while the projector is mounted on the wall or ceiling.

1. Turn off the projector and unplug the power cord.
2. Loosen the screws securing the air filter cover.

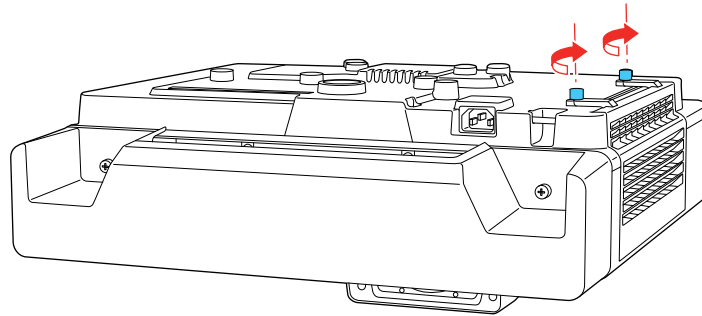

3. Open the air filter cover.

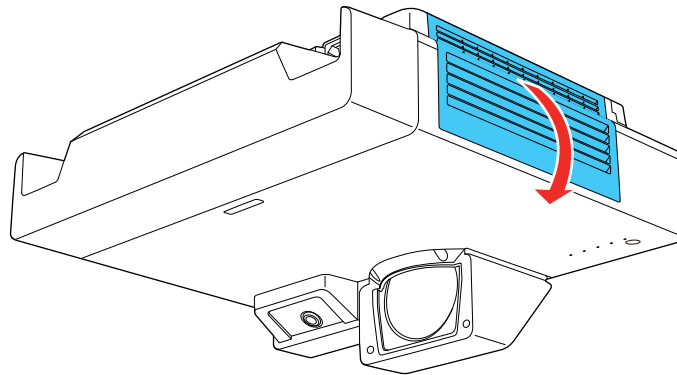

4. Pull the air filter out of the projector.

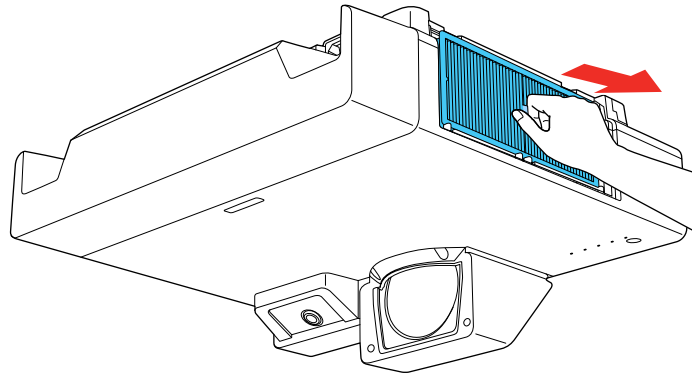

Note: Air filters contain polypropylene. Dispose of used air filters according to local regulations.

5. Place the new air filter in the projector as shown.

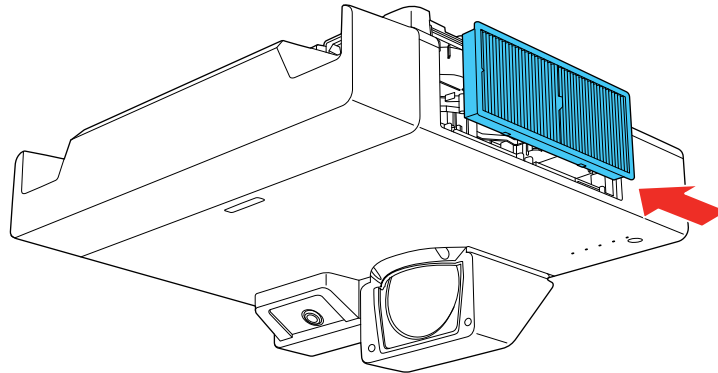

6. Close the air filter cover and tighten the screws.

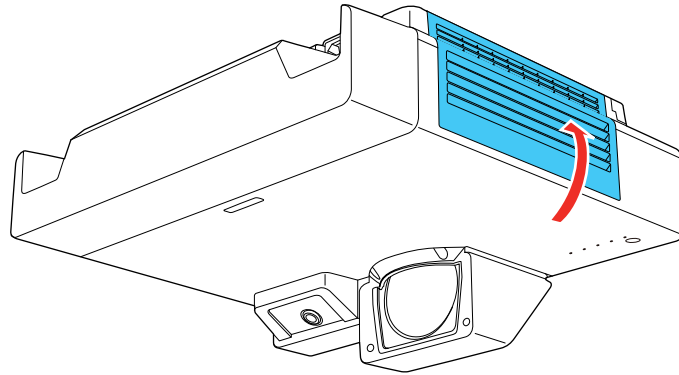

Parent topic: [Air Filter and Vent Maintenance](#)

Related tasks

[Turning Off the Projector](#)

Replacing the Remote Control Batteries

The remote control uses two AA manganese or alkaline batteries. Replace the batteries as soon as they run out.

Caution: Use only the type of batteries specified in this manual. Do not install batteries of different types, or mix new and old batteries.

1. Remove the battery cover as shown.

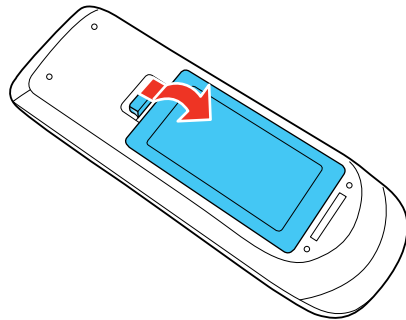

2. Remove the old batteries.

Warning: If the battery fluid has leaked, wipe it away with a soft cloth and avoid getting the fluid on your hands. If it gets on your hands, wash them immediately to avoid injury.

3. Insert the batteries with the + and – ends facing as shown.

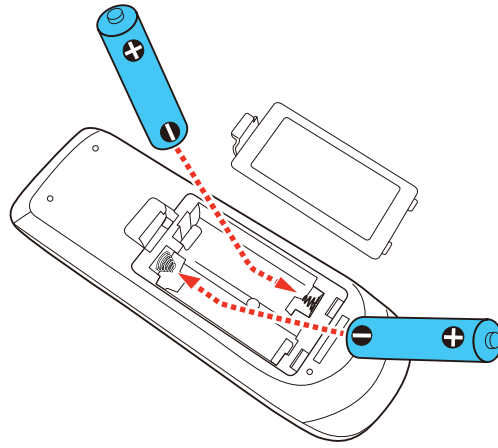

Warning: Make sure the batteries are inserted in the correct positions. If the batteries are not inserted correctly, they could explode or leak, causing a fire, injury, or damage to the product.

4. Replace the battery cover and press it down until it clicks into place.

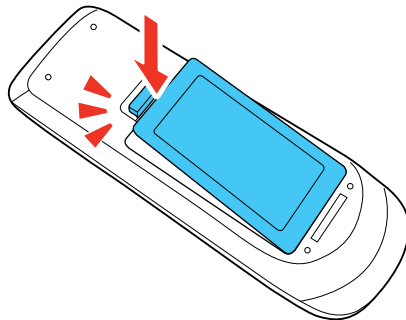

Warning: Dispose of used batteries according to local regulations. Do not expose batteries to heat or flame. Keep batteries out of the reach of children; they are choking hazards and are very dangerous if swallowed.

Parent topic: [Maintaining and Transporting the Projector](#)

Replacing the Hard Pen Tips

If the pen tips become damaged or no longer work correctly, you can replace them.

Note: If you are using an ultra-wide display screen with an aspect ratio of 16:6, use only the hard pen tip (BrightLink 1485Fi).

1. Twist off the tip of the pen to remove it.

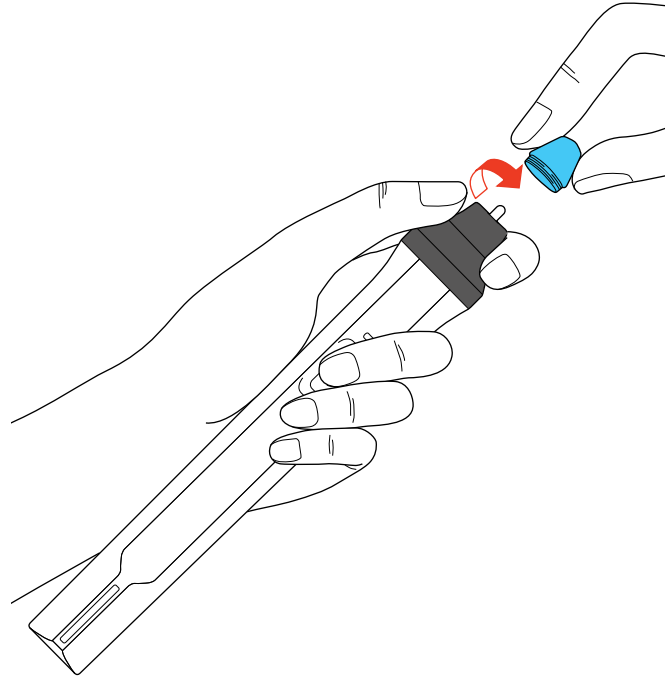

2. Twist on the new tip.

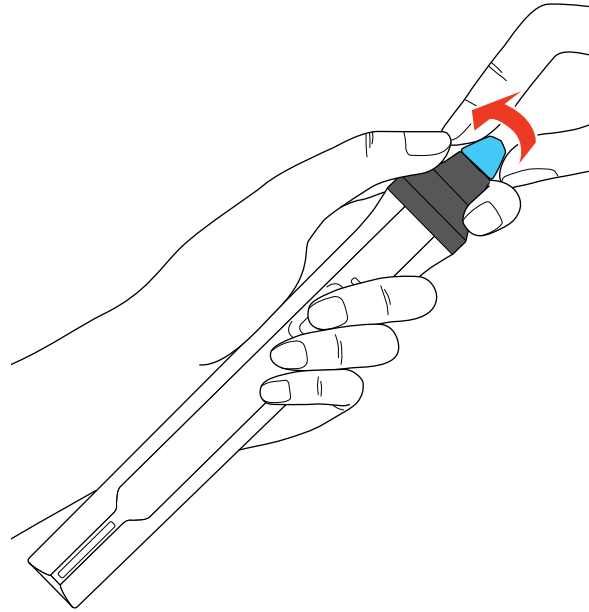

Parent topic: [Maintaining and Transporting the Projector](#)

Replacing the Soft Pen Tips

If the pen tips become damaged or no longer work correctly, you can replace them. If the soft tip is difficult to use on a textured surface, replace it with the hard pen tip.

Note: If you are using an ultra-wide display screen with an aspect ratio of 16:6, use only the hard pen tip (BrightLink 1485Fi).

1. Twist off the tip of the pen to remove it.

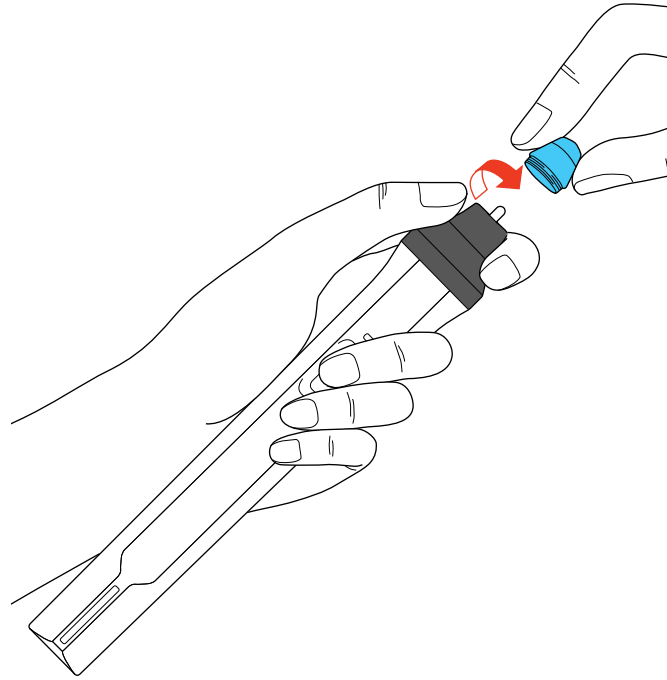

2. Remove the soft tip.

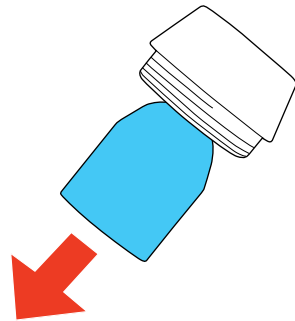

3. Insert the new tip.

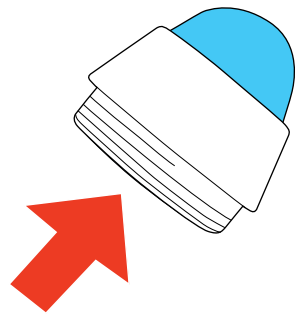

4. Twist on the pen tip.

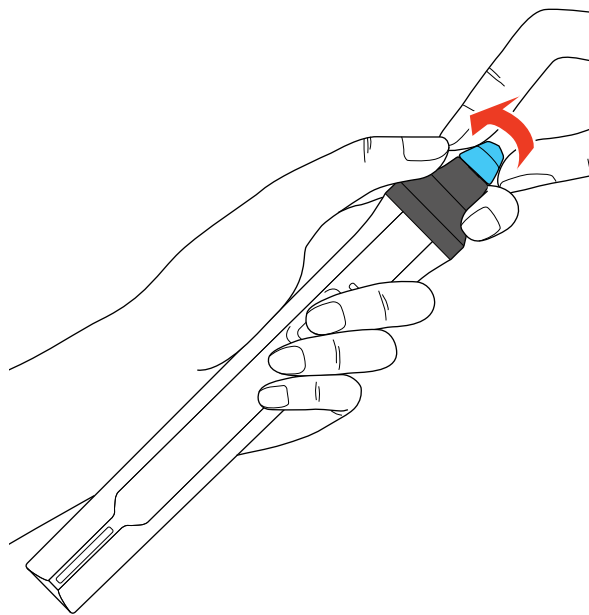

Parent topic: [Maintaining and Transporting the Projector](#)

Updating the Firmware

You can update the projector's firmware using a USB storage device or a computer and a USB cable.

If a firmware update is available for your product, you can select the **Firmware Update** option in the projector's Initial/All Settings menu. The projector enters firmware update mode and is ready to perform a firmware update. If a firmware update file is not found, the projector enters standby mode.

You can contact Epson Support or use the Epson Projector Management software to check for firmware updates for your product. For more information, contact Epson Support.

Parent topic: [Maintaining and Transporting the Projector](#)

Transporting the Projector

The projector contains precision parts, some of which are glass. Follow the guidelines here to transport, ship, or store the projector safely.

1. Remove any equipment connected to the projector.
2. Turn off the projector.
3. Make sure the  power light is blue (but not flashing) and the status light is off, then unplug the power cord.
4. Attach the lens cap.
5. Do one of the following:
 - When transporting the projector a long distance or as checked luggage, pack it in a firm box with cushioning around it and mark the box "Fragile."
 - When shipping the projector for repairs, place it in its original packing materials, if possible, or use equivalent materials with cushioning around the projector. Mark the box "Fragile."

Note: Epson shall not be liable for any damages incurred during transportation.

Parent topic: [Maintaining and Transporting the Projector](#)

Solving Problems

Check the solutions in these sections if you have any problems using the projector.

[Projection Problem Tips](#)

[Projector Light Status](#)

[Using the Projector Menu Displays](#)

[Solving Image or Sound Problems](#)

[Solving Projector or Remote Control Operation Problems](#)

[Solving Network Problems](#)

[Solving Interactive Problems](#)

[Where to Get Help \(U.S. and Canada\)](#)

Projection Problem Tips

If the projector is not working properly, try turning it off and unplugging it. Then plug it back in and turn it on.

If this does not solve the problem, check the following:

- The lights on the projector may indicate what the problem is.
- The solutions in this manual can help you solve many problems.

If none of these solutions help, you can contact Epson for technical support.

Parent topic: [Solving Problems](#)

Related references

[Where to Get Help \(U.S. and Canada\)](#)

[Projector Light Status](#)

Related tasks

[Cleaning the Lens](#)

[Turning On the Projector](#)

[Turning Off the Projector](#)

[Cleaning the Air Filter and Vents](#)

[Replacing the Air Filter](#)

Projector Light Status

The lights on the projector indicate the projector status and let you know when a problem occurs. Check the status and color of the lights and look for a solution in the table here.

Note: If the **Indicators** setting in the **Operation** menu is **Off**, all lights are off under normal projection conditions.

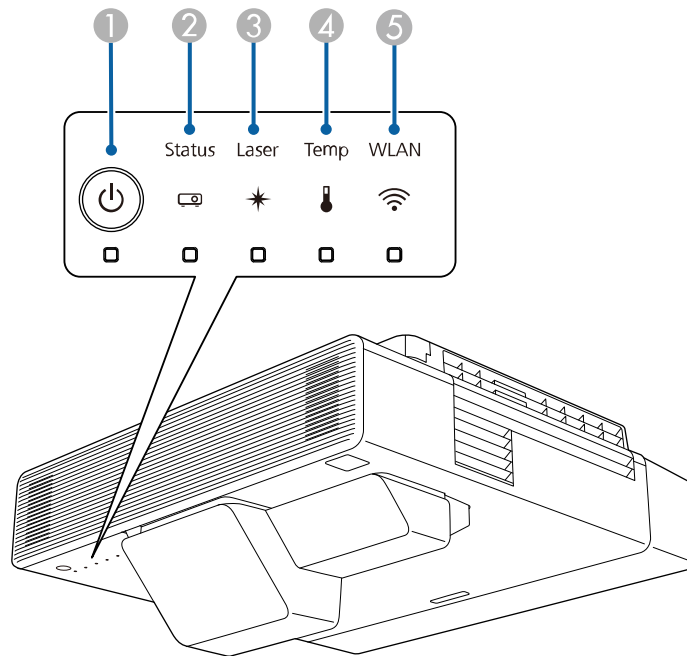

- 1 Power light
- 2 Status light
- 3 Laser light
- 4 Temp (temperature) light
- 5 Wireless LAN light

Power light	Status light	Laser light	Temp light	Status and solution
Blue	Blue	Off	Off	Normal operation.
Blue	Flashing blue	Off	Off	Warming up. Wait for an image to appear. Shutting down. (When the Status light stops flashing, you can unplug the projector.)
Blue	Off	Off	Off	In standby, sleep mode, or monitoring.
Flashing blue	Off	Off	Off	Preparing for monitoring or quick startup mode; all features are disabled.
Flashing blue	Varies	Varies	Flashing orange	Projector is too hot. <ul style="list-style-type: none"> • Make sure that the vents and air filter are not clogged with dust or obstructed by nearby objects. • Clean or replace the air filter. • Make sure the environmental temperature is not too hot.

Power light	Status light	Laser light	Temp light	Status and solution
Off	Flashing blue	Off	Orange	<p>Projector has overheated and turned off. Leave it turned off to cool down. After about five minutes, do the following:</p> <ul style="list-style-type: none"> • Make sure that the vents and air filter are not clogged with dust or obstructed by nearby objects. • Make sure the environmental temperature is not too hot. • Clean or replace the air filter. • If operating the projector at high altitude, turn on High Altitude Mode. • If the problem persists, unplug the projector and contact Epson for help.
Flashing blue	Varies	Flashing orange	Varies	Laser warning. Turn the projector off, unplug it, and contact Epson for help.
Off	Flashing blue	Orange	Off	Laser has a problem. Turn the projector off, unplug it, and contact Epson for help.
Off	Flashing blue	Off	Flashing orange	A fan or sensor has a problem. Turn the projector off, unplug it, and contact Epson for help.
Off	Flashing blue	Flashing orange	Off	Internal projector error. Turn the projector off, unplug it, and contact Epson for help.
Varies	Flashing blue	Flashing orange	Varies	Refresh Mode is in progress.

Power light	Status light	Laser light	Temp light	Status and solution
Varies	Varies	Fast flashing orange	Fast flashing orange	The batch setup file is corrupt or the USB flash drive is connected incorrectly. Disconnect the USB flash drive and turn off the projector. Unplug the projector, plug it in again, and try again.
Fast flashing blue	Fast flashing blue	Fast flashing orange	Fast flashing orange	Writing the menu settings has failed and an error in the projector's firmware has occurred. Turn the projector off, unplug it, and contact Epson for help.

Wireless LAN Light Status

The Wireless LAN light indicates the following:

- **Blue:** Wireless LAN is available and operating normally
- **Flashing blue (quickly):** Connecting to a device
- **Flashing blue (slowly):** An error has occurred. Turn off the projector and restart it
- **Off:** Wireless LAN is not available. Make sure the **Wireless LAN Power** setting is set to **On** in the projector's **Management** menu

Note: If the lights display a pattern not listed in the tables above, turn the projector off, unplug it, and contact Epson for help.

Parent topic: [Solving Problems](#)

Related references

[Where to Get Help \(U.S. and Canada\)](#)

[Feature Settings - Operation Menu](#)

[Administration Settings - Management Menu](#)

Using the Projector Menu Displays

The projector displays descriptions in the menu system to help you navigate the projector's settings. The descriptions appear on the right side of the screen as you scroll the menu settings.

Parent topic: [Solving Problems](#)

Solving Image or Sound Problems

Check the solutions in these sections if you have any problems with projected images or sound.

[Solutions When No Image Appears](#)

[Solutions When Image is Incorrect Using the USB Display Function](#)

[Solutions When "No Signal" Message Appears](#)

[Solutions When "Not Supported" Message Appears](#)

[Solutions When Only a Partial Image Appears](#)

[Solutions When the Image is Not Rectangular](#)

[Solutions When the Image Contains Noise or Static](#)

[Solutions When the Image is Fuzzy or Blurry](#)

[Solutions When the Image Brightness or Colors are Incorrect](#)

[Solutions When an Afterimage Remains On the Projected Image](#)

[Solutions to Sound Problems](#)

[Solutions to Microphone Problems](#)

Parent topic: [Solving Problems](#)

Solutions When No Image Appears

If no image appears, try the following solutions:

- Make sure the lens cap is off.
- Press the **A/V Mute** button on the remote control to see if the image was temporarily turned off.
- Make sure all necessary cables are securely connected and the power is on for the projector and connected video sources.
- If you connected your video source to the **Computer2/Monitor Out** port, make sure you set the **Monitor Out Port** setting to **Computer2**.
- Make sure the image being projected is not completely black (only when projecting computer images).
- Press the projector's power button to wake it from standby or sleep mode. Also see if your connected computer is in sleep mode or displaying a blank screen saver.
- Press the **Menu** button. If the projector menu displays, there may be a problem with the connected video source, cable connection, or port.
- Adjust the **Brightness** setting on the Image menu.
- Adjust the brightness of your projector's light source.

- Check the Display menu to make sure the **Messages** setting is set to **On**.
- If the projector does not respond when you press the control panel buttons, the buttons may be locked. Unlock the buttons.
- If the projector does not respond when you press buttons on the remote control, make sure the remote receivers are turned on.
- For images projected with Windows Media Center, reduce the screen size from full screen mode.
- For images projected from applications using Windows DirectX, turn off DirectX functions.
- The projector may not be able to project copyrighted videos that you play back on a computer. For details, see the manual supplied with your computer.
- If you cannot project a screen mirroring image, make sure the **Capture** setting is disabled.
- If the other solutions do not solve the problem, reset all of the projector settings using the options on the **Reset** menu.

Parent topic: [Solving Image or Sound Problems](#)

Related references

[Display Settings - Display Menu](#)

[Setup Settings - ECO Menu](#)

[Installation Settings - Installation Menu](#)

[Input Signal Settings - Signal I/O Menu](#)

[Image Quality Settings - Image Menu](#)

Related tasks

[Selecting an Image Source](#)

[Unlocking the Projector's Buttons](#)

[Shutting Off the Picture and Sound Temporarily](#)

[Selecting Screen Mirroring Settings](#)

Solutions When Image is Incorrect Using the USB Display Function

If no image appears or if the image appears incorrectly using the USB Display function, try the following solutions:

- Press the **USB** button on the remote control.
- Press the **Source Search** button on the remote control or control panel, and select **USB Display**.
- Make sure the USB Display software has installed correctly. Install it manually if necessary.
- Make sure your computer is connected to the **USB-B1** port on the projector.

- Make sure the **USB Display** setting is set to **On** in the projector's Signal I/O menu.
- On a Mac, select the **USB Display** icon in the Dock or from the **Applications** folder. If you select Exit from the USB Display icon menu in the Dock, USB Display does not start automatically when you connect the USB cable.
- For images projected with Windows Media Center, reduce the screen size from full screen mode.
- For images projected from applications using Windows DirectX, turn off DirectX functions.
- If the mouse cursor flickers, select **Make the movement of the mouse pointer smooth** in the Epson USB Display Settings program on your Windows computer.
- Turn off the **Transfer layered window** setting in the Epson USB Display Settings program on your Windows computer.
- If you change the computer resolution during projection, the video quality and performance may decline.
- Make sure you are using the most recent version of the USB Display software. You can download the latest version from the Epson web site. Go to epson.com/support (U.S.) or epson.ca/support (Canada) and select your projector.

Parent topic: [Solving Image or Sound Problems](#)

Related references

[Input Signal Settings - Signal I/O Menu](#)

Related tasks

[Selecting an Image Source](#)

[Connecting to a Computer for USB Video and Audio](#)

Solutions When "No Signal" Message Appears

If the "No Signal" message appears, try the following solutions:

- Press the **Source Search** button and wait a few seconds for an image to appear.
- Turn on the connected computer or video source, and press its play button to begin your presentation, if necessary.
- Check the connection from the projector to your video sources.
- If you are projecting from a laptop computer, make sure it is set up to display on an external monitor.
- If necessary, turn the projector and the connected computer or video source off and then on again.
- If you are projecting from an HDMI source, change the **HDMI EQ Setting** setting in the projector's Signal I/O menu.

- If you are projecting using a thumb-sized media streaming device, set the **HDMI EQ Setting** to **1** in the projector's Signal I/O menu.
- If you are projecting from an HDMI source, replace the HDMI cable with a shorter one.
- Connect the video source directly to the projector.
- Try a different video cable.
- If the other solutions do not solve the problem, reset all of the projector settings using the options on the **Reset** menu.

[Displaying From a PC Laptop](#)

[Displaying From a Mac Laptop](#)

Parent topic: [Solving Image or Sound Problems](#)

Related tasks

[Selecting an Image Source](#)

[Connecting to an External Computer Monitor](#)

Related topics

[Connecting to Computer Sources](#)

[Connecting to Video Sources](#)

Displaying From a PC Laptop

If you see the "No Signal" message when you display from a PC laptop, you need to set up the laptop to display on an external monitor.

1. Hold down the laptop's **Fn** key and press the key labeled with a monitor icon or **CRT/LCD**. (See your laptop manual for details.) Wait a few seconds for an image to appear. To display on both the laptop's monitor and the projector, try pressing the same keys again.

Note: On Windows 7 or later, hold down the Windows key and press **P** at the same time, then click **Duplicate**.

2. If the same image is not displayed by the laptop and projector, check the Windows **Display** utility to make sure the external monitor port is enabled and extended desktop mode is disabled. (See your computer or Windows manual for instructions.)
3. If necessary, check your video card settings and set the multiple display option to **Clone**, **Mirror**, or **Duplicate**.

Parent topic: [Solutions When "No Signal" Message Appears](#)

Displaying From a Mac Laptop

If you see the "No Signal" message when you display from a Mac laptop, you need to set up the laptop for mirrored display. (See your laptop manual for details.)

1. Open the **System Preferences** utility and select **Displays**, **Display**, or **Color LCD**.
2. Click the **Arrange** or **Arrangement** tab.
3. Select the **Mirror Displays** checkbox.

Parent topic: [Solutions When "No Signal" Message Appears](#)

Solutions When "Not Supported" Message Appears

If the "Not Supported" message appears, try the following solutions:

- Make sure the correct input signal is selected on the Signal I/O menu.
- Make sure the computer's display resolution does not exceed the projector's resolution and frequency limit. If necessary, select a different display resolution for your computer. (See your computer manual for details.)

Parent topic: [Solving Image or Sound Problems](#)

Related references

[Input Signal Settings - Signal I/O Menu](#)

Solutions When Only a Partial Image Appears

If only a partial computer image appears, try the following solutions:

- For VGA connections, press the **Auto** button on the remote control to optimize the image signal.
- Make sure you selected the correct **Screen Type** setting in the projector's Installation menu for the screen you are using. If there are margins between the edge of the image and the projected screen frame, use the **Screen Position** setting to adjust the position of the image.
- Make sure the **Scale** setting in the Image menu is turned off (BrightLink 1485Fi).
- Make sure the **Resolution** setting in the Image menu is set correctly for the input signal.
- Try adjusting the image position using the **Position** setting in the Image menu.
- When using the interactive features with an aspect ratio of 16:6, set the **Screen Position** to a vertically centered or higher position.
- Press the **Aspect** button on the remote control to select a different image aspect ratio.
- Check the **Blanking** setting in the Installation menu.

- If you zoomed into or out of the image using the **E-Zoom** buttons, press the **Esc** button until the projector returns to a full display.
- Check your computer display settings to disable dual display and set the resolution within the projector's limits. (See your computer manual for details.)
- Check the resolution assigned to your presentation files to see if they are created for a different resolution than you are projecting in. (See your software help for details.)
- Make sure you selected the correct **Projection** setting in the Installation menu.
- Try adjusting the image position using the **Image Shift** setting.
- If the image is not projected correctly when using multiple projectors, set the Screen Type setting in the Installation menu to **16:9**.
- If you see black bands in the projected screen when using multiple projectors, set EDID to **3240x1080/60Hz** and Blend Range to **600** for both projectors.

Note: If you cannot select **600** as the Blend Range setting, select a lower setting. Black bands may appear on the side of the projected screen.

Parent topic: [Solving Image or Sound Problems](#)

Related references

[Multiple Projector Operation Settings - Multi-Projection Menu](#)

[Input Signal Settings - Signal I/O Menu](#)

[Installation Settings - Installation Menu](#)

[Image Quality Settings - Image Menu](#)

Related tasks

[Changing the Image Aspect Ratio](#)

[Zooming Into and Out of Images](#)

Solutions When the Image is Not Rectangular

If the projected image is not evenly rectangular, try the following solutions:

- If the projector is not mounted on the wall or ceiling, place it directly in front of the screen, lining up the lens with the center of the screen, if possible.
- Use the **Image Shift** setting to adjust the image position, rather than moving the projector.
- Press the keystone buttons on the projector to adjust the image shape.
- Adjust the image shape using the individual **Geometry Correction** settings in the Installation menu.

Note: Adjusting **Quick Corner**, **H/V-Keystone**, and **Arc Correction** settings may affect focus and pen calibration.

Note: If the projector is mounted on the wall, always use the adjustment dials on the mount to center the image.

Parent topic: [Solving Image or Sound Problems](#)

Related references

[Installation Settings - Installation Menu](#)

[Image Quality Settings - Image Menu](#)

Related tasks

[Correcting Image Shape with Arc Correction](#)

[Correcting Image Shape with the Keystone Buttons](#)

[Correcting Image Shape with Quick Corner](#)

Solutions When the Image Contains Noise or Static

If the projected image seems to contain electronic interference (noise) or static, try the following solutions:

- Check the cables connecting your computer or video source to the projector. They should be:
 - Separated from the power cord to prevent interference
 - Securely connected at both ends
 - Not connected to an extension cable
- Make sure you selected the correct **Signal Format** or **EDID** settings in the projector's Signal I/O menu, if available for your image source.
- Adjust the **Noise Reduction**, **MPEG Noise Reduction**, and **Deinterlacing** settings in the projector's Image menu.
- If available for your video source, select **Auto** as the **Resolution** setting in the Image menu.
- Select a computer video resolution and refresh rate that are compatible with the projector.
- If you are projecting from a computer using a VGA cable, press the **Auto** button on the remote control to automatically adjust the tracking and sync. If the problem remains, display a uniformly patterned image on the screen and manually adjust the **Tracking** and **Sync** settings.
- If you adjusted the image shape using the projector controls, try decreasing the **Sharpness** setting to improve image quality.

- If you connected an extension power cable, try projecting without it to see if it caused interference in the signal.
- If you are using the USB Display function, turn off the **Transfer layered window** setting in the Epson USB Display Settings program on your Windows computer.

Parent topic: [Solving Image or Sound Problems](#)

Related references

[Input Signal Settings - Signal I/O Menu](#)

[Supported Video Display Formats](#)

[Image Quality Settings - Image Menu](#)

Related topics

[Connecting to Video Sources](#)

[Connecting to Computer Sources](#)

Solutions When the Image is Fuzzy or Blurry

If the projected image is fuzzy or blurry, try the following solutions:

- Adjust the image focus.
- Clean the projector lens.
- Position the projector close enough to the screen, and directly in front of it.
- Verify that the throw distance from the projector to your projection surface meets the specifications in your projector's online *Installation Guide*.
- Position the projector so the keystone adjustment angle is not so wide that it distorts the image.
- Adjust the **Sharpness** setting to improve image quality.
- If you are projecting from a computer using a VGA cable, press the **Auto** button on the remote control to automatically adjust the tracking and sync. If any bands or overall blurriness remain, display a uniformly patterned image on the screen and manually adjust the **Tracking** and **Sync** settings.
- If you are projecting from a computer, use a lower resolution or adjust the computer's resolution to match the projector's native resolution, if possible.

Parent topic: [Solving Image or Sound Problems](#)

Related references

[Image Quality Settings - Image Menu](#)

Related tasks

[Focusing the Image](#)

[Cleaning the Lens](#)

Solutions When the Image Brightness or Colors are Incorrect

If the projected image is too dark or light, or the colors are incorrect, try the following solutions:

- Press the **Color Mode** button on the remote control to try different color modes for the image and environment.
- Check your video source settings.
- Adjust the available settings on the Image menu for the current input source, such as **Brightness**, **Contrast**, **Tint**, **White Balance**, **Color Saturation** and **RGBCMY**.
- Make sure you selected the correct **Signal Format** or **EDID** setting in the Signal I/O menu, if available for your video source.
- Make sure all the cables are securely connected to the projector and your video device. If you connected long cables, try connecting shorter cables.
- Position the projector close enough to the screen.
- Make sure you have run the **Light Source Calibration** in the Management menu recently. If using multiple projectors, perform the calibration on all projectors to ensure a consistent image quality.
- When using multiple projectors and the color of the projected image does not match between the projectors, set Color Mode to **Multi-Projection** and adjust the Color Uniformity, Light Source Brightness Control, Color Matching, Black Level, and RGBCMY settings to resolve the color differences.

Parent topic: [Solving Image or Sound Problems](#)

Related references

[Input Signal Settings - Signal I/O Menu](#)

[Feature Settings - Operation Menu](#)

[Administration Settings - Management Menu](#)

[Image Quality Settings - Image Menu](#)

[Multiple Projector Operation Settings - Multi-Projection Menu](#)

Solutions When an Afterimage Remains On the Projected Image

If you see an afterimage in the projected image, select **Refresh Mode > Start** in the Management menu.

Parent topic: [Solving Image or Sound Problems](#)

Related references

[Administration Settings - Management Menu](#)

Solutions to Sound Problems

If there is no sound when you expect it or the volume is too low or high, try the following solutions:

- Adjust the projector's volume settings.
- Press the **A/V Mute** button on the remote control to resume video and audio if they were temporarily stopped.
- Check your computer or video source to make sure the volume is turned up and the audio output is set for the correct source.
- Try disconnecting and reconnecting the audio cable.
- Check the audio cable connections between the projector and your video source.
- If you do not hear sound from an HDMI source, set the connected device to PCM output.
- Make sure any connected audio cables are labeled "No Resistance."
- If you are using the USB Display function, turn on the **Output audio from the projector** setting in the Epson USB Display Settings program on your computer.
- If you are using a Mac and you do not hear sound from an HDMI source, make sure your Mac supports audio through the HDMI port. If not, you need to connect an audio cable.
- If you want to use a connected audio source when the projector isn't projecting any images, set the **Quick Startup** option in the Operation menu to **Off** and make sure the **A/V Output** setting in the Signal I/O menu is set to **Always On**.
- If the volume for the computer is set to the minimum while the projector's volume is set to maximum, the sound level may be mixed. Turn up the computer's volume and decrease the projector's volume (when using Epson iProjection [Windows/Mac] or USB Display).
- Make sure the **Audio Output Device** option is set to the correct audio port for your video device.
- If you turn the projector on immediately after turning it off, the cooling fans may run at high speed momentarily and cause an unexpected noise. This is normal.

Parent topic: [Solving Image or Sound Problems](#)

Related references

[Input Signal Settings - Signal I/O Menu](#)

Related tasks

[Connecting to a Computer for Sound](#)

[Connecting to a Video Source for Sound](#)

[Connecting to External Speakers](#)

[Controlling the Volume with the Volume Buttons](#)

Solutions to Microphone Problems

If there is no sound when you use a microphone connected to the projector, try the following solutions:

- Make sure the microphone is securely connected to the projector.
- Adjust the **Mic Input Level** setting in the Signal I/O menu. If the setting is too high, the sound of the other connected devices will be too low.

Parent topic: [Solving Image or Sound Problems](#)

Related references

[Input Signal Settings - Signal I/O Menu](#)

Related tasks

[Connecting a Microphone](#)

Solving Projector or Remote Control Operation Problems

Check the solutions in these sections if you have problems operating the projector or remote control.

[Solutions to Projector Power or Shut-Off Problems](#)

[Solutions to Remote Control Problems](#)

[Solutions to Password Problems](#)

[Solutions When a Battery Message Appears](#)

Parent topic: [Solving Problems](#)

Solutions to Projector Power or Shut-Off Problems

If the projector does not come on when you press the power button or it shuts off unexpectedly, try the following solutions:

- Make sure the power cord is securely connected to the projector and to a working electrical outlet.
- The projector's buttons may be locked for security. Unlock the buttons or use the remote control to turn on the projector.
- If the projector's laser shuts off unexpectedly, it may have entered standby mode after a period of inactivity. Press the power button to wake the projector and adjust the **Sleep Mode** setting to change the sleep interval. The **A/V Mute Timer** may be set. Set the **A/V Mute Timer** to **Off** in the Operation menu.
- If the projector's laser shuts off, the Status light is flashing, and the Temp light is on, the projector has overheated and shut off. Check the solutions for this light status.

- If the power button on the remote control does not turn on the projector, check its batteries and make sure the **Remote Receiver** setting is turned on in the projector's menu, if available.
- The power cord may be defective. Try another power cord. If that doesn't work, disconnect the cord and contact Epson.
- The cooling fans may run in standby status depending on the projector settings. Also, when the projector wakes from standby status, the fans may cause an unexpected noise. This is not a malfunction.

Parent topic: [Solving Projector or Remote Control Operation Problems](#)

Related references

[Where to Get Help \(U.S. and Canada\)](#)

[Projector Light Status](#)

[Feature Settings - Operation Menu](#)

Related tasks

[Unlocking the Projector's Buttons](#)

Solutions to Remote Control Problems

If the projector does not respond to remote control commands, try the following solutions:

- Check that the remote control batteries are installed correctly and have power. If necessary, replace the batteries.
- Make sure you are operating the remote control within the reception angle and range of the projector.
- Make sure the projector is not warming up or shutting down.
- Check to see if a button on the remote control is stuck down, causing it to enter sleep mode. Release the button to wake the remote control up.
- Strong fluorescent lighting, direct sunlight, or infrared device signals may be interfering with the projector's remote receivers. Dim the lights or move the projector away from the sun or interfering equipment.
- If available, turn on one of the remote receivers in the projector's menu system, or check if all the remote receivers were turned off.
- If the remote receiver setting is off, press and hold the **Menu** button on the remote for at least 15 seconds to restore the default setting.
- If you assigned an ID number to the remote control to operate multiple projectors, you may need to check or change the ID setting (feature not available with all projectors).

- To set the remote control so it will operate any projector, hold down the **ID** button and press the **0/All** button.
- If you lose the remote control, you can purchase another from an Epson parts distributor.

Parent topic: [Solving Projector or Remote Control Operation Problems](#)

Related references

[Remote Control Operation](#)

Related tasks

[Installing Batteries in the Remote Control](#)

[Replacing the Remote Control Batteries](#)

Solutions to Password Problems

If you cannot enter or remember a password, try the following solutions:

- You may have turned on password protection without first setting a password. Try entering **0000** using the remote control. If you lose the remote control, you cannot enter a password. Order a new one from Epson.
- If you have entered an incorrect password too many times and see a message displaying a request code, write down the code and contact Epson. Do not attempt to enter the password again. Provide the request code and proof of ownership for assistance in unlocking the projector.
- If you set a Epson Web Control password and forgot the user ID or password, try entering the following:
 - User ID: **EPSONWEB**
 - Default password: **admin**
- If you set a Remote password (in Epson Web Control) and forgot the user ID or password, try entering the following:
 - User ID: **EPSONREMOTE**
 - Default password: **guest**

Parent topic: [Solving Projector or Remote Control Operation Problems](#)

Related concepts

[Projector Security Features](#)

Solutions When a Battery Message Appears

If you see a message telling you that the battery that saves your clock settings is running low, contact Epson for help.

Parent topic: [Solving Projector or Remote Control Operation Problems](#)

Related references

[Where to Get Help \(U.S. and Canada\)](#)

Solving Network Problems

Check the solutions in these sections if you have problems using the projector on a network.

[Solutions When Wireless Authentication Fails](#)

[Solutions When You Cannot Access the Projector Through the Web](#)

[Solutions When Network Alert E-Mails are Not Received](#)

[Solutions When the Image Contains Static During Network Projection](#)

[Solutions When You Cannot Connect Using Screen Mirroring](#)

[Solutions When the Image or Sound Contains Static When Using Screen Mirroring](#)

[Solutions When the Projected Screen is not Shared Correctly](#)

Parent topic: [Solving Problems](#)

Solutions When Wireless Authentication Fails

If you cannot authenticate a wireless connection, try the following solutions:

- If the wireless settings are correct, but authentication fails, you may need to update the **Date & Time** settings in the Management menu, if available.
- Check the **Security** settings and passphrase in the Network menu.
- Make sure the connected device is on and operating properly.
- If the access point security is WPA3-EAP, change the access point setting to **WPA2/WPA3-EAP**.

Parent topic: [Solving Network Problems](#)

Related references

[Event ID Code List](#)

[Network Settings - Network Menu](#)

[Administration Settings - Management Menu](#)

Related tasks

[Setting the Date and Time](#)

Solutions When You Cannot Access the Projector Through the Web

If you are unable to access the projector through a web browser, make sure you are using the correct ID and password, which are case sensitive.

Note: You cannot change the user ID.

- You may need to log in to access some options on the Web Control screen. If you see a log in window, enter **EPSONWEB** as the user ID and enter the password set in the projector's Network menu as the password. The default password is **admin**.
- Avoid connecting via a proxy server.
- Make sure you have access to the network the projector is on.
- Check the IP address on the projector, then reenter the IP address in the browser search bar.

Note: The user ID and password are case sensitive.

Parent topic: [Solving Network Problems](#)

Solutions When Network Alert E-Mails are Not Received

If you do not receive an e-mail alerting you to problems with a projector over the network, try the following solutions:

- Make sure the projector is turned on and connected to the network correctly. (If an error shut down the projector, it cannot send an e-mail.)
- Make sure you set up the projector e-mail alert settings correctly on the projector's Network Mail Notification menu or in the network software.
- Set the **Standby Mode** setting to **Communication On** so the network software can monitor the projector in standby mode. Change the **Port** setting according to your network environment.

Parent topic: [Solving Network Problems](#)

Related references

[Network Projector E-mail Alert Messages](#)

Related tasks

[Setting Up Projector Network E-Mail Alerts](#)

Solutions When the Image Contains Static During Network Projection

If the projected image contains static during network projection, try the following solutions:

- Check for any obstacles between the access point, the computer, the mobile device, and the projector. If necessary, change their positions to improve communication. Also make sure that they are not too far apart; move them closer together and try to connect again.
- If the wireless connection is slow or your projected image contains noise, check for interference from other equipment, such as a Bluetooth device or microwave. Move the interfering device farther away or expand your wireless bandwidth.
- If the connection speed declines, reduce the number of connected devices.

Parent topic: [Solving Network Problems](#)

Solutions When You Cannot Connect Using Screen Mirroring

If you are unable to connect to the projector using Screen Mirroring, try the following solutions:

- Select **On** as the **Screen Mirroring** setting in the projector's Network menu.
- Select **On** as the **Simple AP** setting in the projector's Network menu.
- Make sure the **Display Name** setting does not contain a dash ("-") or it may not be displayed correctly on the mobile device.
- Select **Off** as the **Screen Mirroring** setting, then select **On** again.
- Make sure the mobile device settings are correct and restart the device.
- You may not be able to connect immediately after disconnecting from the projector. Wait a while and try connecting again.
- If you have previously connected to the projector using Screen Mirroring, the device may have saved the previous connection information. Delete the saved information and connect to the projector from the list of available devices.
- If you are unable to use two Screen Mirroring sources at the same time, set the **Interrupt Connection** setting to **Off**.

Parent topic: [Solving Network Problems](#)

Solutions When the Image or Sound Contains Static When Using Screen Mirroring

If the projected image or sound contains static when connecting using Screen Mirroring, try the following solutions:

- Avoid covering the Wi-Fi antenna of the mobile device.

- If you use a Screen Mirroring connection and an internet connection at the same time, the image may freeze or contain noise. Disconnect from the internet to improve the connection speed of the mobile device.
- Make sure the projection contents meet the Screen Mirroring requirements.
- Depending on the settings of the mobile device, the connection may be lost when the device enters power saving mode. Check the power saving settings on the mobile device.
- Make sure your mobile device has the latest version of its wireless driver and firmware installed.

Parent topic: [Solving Network Problems](#)

Solutions When the Projected Screen is not Shared Correctly

If the Screen Sharing feature does not deliver the screen to a receiving projector properly, try the following solutions:

- Connect the projector to the same network as the projector that is sharing its screen.
- Make sure the receiving projector supports the Screen Sharing function.
- Make sure the **Screen Sharing** setting in the Network menu is set to **On** for all projectors.
- Close any running Epson iProjection (Windows/Mac) software.
- Make sure the image being projected is not protected by copyright.
- Make sure **Sharing** is displayed on the status bar that appears in the upper center part of the screen. If it is not displayed, try reconnecting.
- If the firmware version of the projectors sharing the screen is not the same, you may need to update the projector's firmware to share your screen.

Parent topic: [Solving Network Problems](#)

Related references

[Network Settings - Network Menu](#)

Related tasks

[Starting a Shared Screen Session](#)

Solving Interactive Problems

Check the solutions in these sections if you have problems using the interactive system.

Note: If the "Error occurred in the Easy Interactive Function" message appears, contact Epson for help.

[Solutions When the Interactive Pens Do Not Work](#)
[Solutions When the Interactive Pen Position Is Not Accurate](#)
[Solutions When the Interactive Pens Are Slow or Difficult to Use](#)
[Solutions When the Interactive Pens Cause Interference or Unwanted Effects](#)
[Solutions When Finger Touch Interactivity Does Not Work](#)
[Solutions When You Cannot Operate a Computer from the Projected Screen](#)
[Solutions for Problems With Capturing, Printing, Saving, or Scanning](#)
[Solutions for Problems with Whiteboard Mode](#)

Parent topic: [Solving Problems](#)

Solutions When the Interactive Pens Do Not Work

If the interactive pens do not work, try the following solutions:

- The pens turn off automatically when not in use. Pick up the pen to turn it back on.
- Make sure **PC Interactivity** is set to **On** on the projector's interactive toolbar.
- Make sure you are not covering the black section near the tip of the pen.
- Make sure the pen tip is securely attached to the pen.
- Try replacing the soft pen tip with the hard pen tip.
- Make sure nothing is blocking the signal between the pen and the interactive pen receiver on the projector.
- Try holding the pen at a different angle so that your hand is not blocking the signal.
- Make sure the cable cover is in place to keep cables from blocking the signal.
- Make sure the pen battery has enough power. Press the button on the side of the pen to check remaining battery power. Try replacing the battery.
- If you are projecting from a computer, make sure the USB cable is connected to the computer and projector.
- Dim the room lights and turn off any fluorescent lights. Make sure the projection surface and pen receiver are not in direct sunlight or other sources of bright lighting.
- Remove any decorative lights from around the projector or projection surface.
- If the pen tip is worn out or damaged, you may need to replace it.
- Make sure the interactive pen receiver on the projector is clean and free from dust.
- Make sure there is no interference from infrared remote controls, mice, or infrared microphones.

- Make sure you have calibrated the system. Try recalibrating.
- If you are using a Mac with your projector, make sure that you installed the Easy Interactive Tools software, and that you have downloaded and installed the latest Easy Interactive Driver from the Epson support site.
- If you are using multiple interactive projectors in the same room, make sure you are using a sync cable between the projectors and that the **Installation of Projectors > Sync of Projectors** setting in the Pen/Touch menu is set to **Wired**. If you do not have a sync cable, set the **Infrared Intensity** setting to **Strong** in the Pen/Touch menu.
- Make sure there are no devices, such as rotary devices or transformers, generating powerful noise near the projector. The interactive features may not operate correctly.
- If you are using Epson iProjection (Windows/Mac) software, select **Set Options** and make sure **Use Interactive Pen** is enabled. Also, select the **Adjust performance** tab and select **Transfer layered window**.
- If you are using a Quick Wireless Connection USB Key, start the Epson Quick Wireless Connections Settings program on your computer, select the **General settings** tab and make sure **Use Interactive Pen** is enabled. Also, select the **Adjust performance** tab and select **Transfer layered window**.
- When using multiple projectors and you are not able to use the interactive feature, check the USB cable connection between the projectors.
 - Make sure the USB cable is securely connected to the **USB-A1** or **USB-A2** port on the first projector.
 - If the USB-B2 setting is **Off** in the Pen/Touch menu, connect the USB cable to the **USB-B1** port of the other projector.
 - If the USB-B2 setting is set to one of the HDMI sources in the Pen/Touch menu, connect the USB cable to the **USB-B2** port of the other projector. The interactive feature is only available when you select the input source specified in the USB-B2 setting.

Parent topic: [Solving Interactive Problems](#)

Related concepts

[Pen Calibration](#)

Related references

[Pen and Touch Setup Settings - Pen/Touch Menu](#)

Related tasks

[Replacing the Hard Pen Tips](#)

[Replacing the Soft Pen Tips](#)

[Using the Pens](#)

Solutions When the Interactive Pen Position Is Not Accurate

If the pen position is not the same as the mouse pointer, try the following solutions:

- Make sure you have calibrated the system. Try manual calibration.
- Reset the keystone, **Quick Corner**, and **Arc Correction** settings to their factory defaults.
- If you mounted the projector using a wall mount and used keystone or other digital correction settings to adjust the image, return the settings to their factory defaults. Instead, use the adjustment dials on the wall mount to adjust the image shape; do not use any digital correction. Then focus the image and recalibrate.
- If you use the **E-Zoom +** button on the remote control to enlarge the image, the pen position is not accurate. When you return the image to the original size, the position should be correct.
- Select **Reset All** from the Initial/All Settings menu to restore the projector settings to their default values.
- Set the output resolution of your computer to match the native resolution of the projector. If you connected your projector through a video scaler, make sure the video scaler output resolution setting matches your projector's native resolution.
- Focus the image to sharpen it.
- Make sure the cable cover is in place to keep cables from blocking the signal.
- Try adjusting the pen operation area.
- In **PC Interactivity** (in the Pen/Touch menu), turn off the **Auto Adjust Pen Area** setting and select the **Manual Adj. Pen Area** setting.

Parent topic: [Solving Interactive Problems](#)

Related concepts

[Pen Calibration](#)

Related references

[Pen and Touch Setup Settings - Pen/Touch Menu](#)

[General Projector Specifications](#)

[Installation Settings - Installation Menu](#)

Related tasks

[Adjusting the Pen Operation Area](#)

[Removing and Attaching the Cable Cover](#)

[Zooming Into and Out of Images](#)

Solutions When the Interactive Pens Are Slow or Difficult to Use

If the pens are difficult to use or respond too slowly, try the following solutions:

- For easier operation, hold the pen perpendicular to the projection surface.
- For the best performance, connect your computer to the projector using a VGA or HDMI cable for display and the USB cable for interactivity.
- If you are using USB Display in Windows, you may need to disable Windows Aero in the Epson USB Display Settings program on your computer.
- If you are having difficulty double-clicking on a Mac, go to the **System Preferences** menu, select **Mouse, Trackpad**, or **Mouse & Trackpad**, and reduce the **Double-click speed**.
- Set the **Pen/Touch > Pen Hovering** setting to **Off**.

Parent topic: [Solving Interactive Problems](#)

Related references

[Pen and Touch Setup Settings - Pen/Touch Menu](#)

Related tasks

[Using the Pens](#)

Solutions When the Interactive Pens Cause Interference or Unwanted Effects

If the pens are causing interference or unwanted effects, try the following solutions:

- When you use two pens at the same time, make sure to use them at least 4 inches (10.16 cm) apart.
- Do not rest the pens on the image area of an interactive table to avoid interference with your computer's mouse.
- Make sure that nothing is blocking the direct line to the interactive pen receiver on the projector.

Parent topic: [Solving Interactive Problems](#)

Solutions When Finger Touch Interactivity Does Not Work

If finger touch interactivity does not work, try the following solutions:

- Make sure a Touch Unit is installed correctly and the cable is properly connected. See your projector's online *Installation Guide* for details.
- If the light on the Touch Unit is not on, check the **Touch Unit** settings in the Pen/Touch menu and make sure the **Power** setting is set to **On**.
- Make sure touch interactivity is activated on the toolbar.

- If you are using a Mac with your projector, make sure that you installed the Easy Interactive Tools software, and that you have downloaded and installed the latest Easy Interactive Driver from the Epson support site.
- Adjust the angle on the Touch Unit. See your projector's online *Installation Guide* for details.
- Make sure there are no obstacles (such as cables) between the Touch Unit's laser diffusion ports and the projection surface. If there are any obstacles that are difficult to move, attach the infrared deflectors to the projection surface. See your projector's online *Installation Guide* for details.
- Remove any decorative lights from around the projector or projection surface.
- If you are having difficulty double-clicking on a Mac, go to the **System Preferences** menu, select **Mouse, Trackpad, or Mouse & Trackpad**, and reduce the **Double-click speed**.
- Make sure there is no interference from infrared remote controls, mice, or infrared microphones.
- Make sure you have performed pen calibration and finger touch calibration. Try recalibrating.
- Keep your clothing or parts of your body more than 0.4 inches (1 cm) away from the projection surface.
- If there are people within 4 inches (10 cm) in front of or around the projection screen or there are any obstacles causing interference, touch operations may not work properly.
- If touch operation does not work correctly even after calibration, check the **Calibration Range** setting in the Pen/Touch menu. Select **Wide** if you drag items when touching the screen or **Narrow** if mouse operations do not work smoothly.
- If you are using multiple projectors and see a touch unit setup error, try the following steps:
 1. Perform touch unit angle adjustment on the first projector, then turn off edge blending on the second projector.
 2. Perform pen/touch auto calibration on the first projector and then perform touch unit angle adjustment on the second projector.
 3. Turn on edge blending on the second projector and then perform pen/touch auto calibration on it again.

Parent topic: [Solving Interactive Problems](#)

Related concepts

[Pen Calibration](#)

Related references

[Pen and Touch Setup Settings - Pen/Touch Menu](#)

[The Whiteboard Toolbar](#)

Related tasks

[Calibrating for Finger Touch Interactivity](#)

[Calibrating Automatically](#)

[Performing Touch Unit Angle Adjustment](#)

Solutions When You Cannot Operate a Computer from the Projected Screen

If you are unable to access a computer from the projected screen, try the following solutions:

- Make sure the **USB Display** setting in the Signal I/O menu is set to **On**.
- Make sure you perform pen calibration when using the interactive pen for the first time so that the projector recognizes the position of the pen correctly.
- Make sure **PC Interactivity** is turned on in the projector's interactive toolbar.
- Make sure the USB cable is securely connected. Disconnect the USB cable, and then reconnect it.
- When you are connecting your computer to the projector's **USB-B2** port, make sure the **USB-B2** setting in the Pen/Touch menu matches the HDMI input your computer is connected to.
- When connecting your computer to either of the control pad's (BrightLink 1485Fi) HDMI ports, make sure to connect your computer to the **USB-B** port on the control pad and not directly to the projector.
- When connecting using Screen Mirroring, you need to set up your computer. Hold down the Windows key and press **K** on your keyboard at the same time, then select **Allow mouse, keyboard, touch, and pen input from this device**.

Parent topic: [Solving Interactive Problems](#)

Solutions for Problems With Capturing, Printing, Saving, or Scanning

If you are having trouble capturing and pasting, or printing, saving, or scanning, try the following solutions:

- If you are having trouble pasting a captured image, make sure the image is not HDCP protected.
- If a black frame appears around a pasted image, it may be because the image was shifted or resized.
- Connect only one printer or multifunction device at a time, and make sure the device is supported by the projector.
- If you are having trouble printing or scanning, make sure the printer is not out of ink, jammed, or in any other error state.

- For USB printing or scanning, make sure the printer is connected to the **USB-A** port on the projector or control pad (BrightLink 1485Fi). If you are using the control pad, make sure a USB cable is connected between the projector's **USB-A** port and the upper **USB-B** port on the control pad.
- For USB printing or scanning, try connecting a different USB cable, and make sure the cables are less than 16 feet (4.9 m) long.
- Check the settings on the Interactive menu.

Parent topic: [Solving Interactive Problems](#)

Related references

[Interactive Settings - Interactive Menu](#)

Related tasks

[Connecting a Printer to the Control Pad](#)

[Connecting a USB Device to the Control Pad](#)

[Connecting a USB Device or Camera to the Projector](#)

Solutions for Problems with Whiteboard Mode

If you are having problems with the whiteboard, try the following solutions:

- Enable the **Drawing Function** setting in the Interactive menu.
- When you create a single unified image projected from multiple projectors, whiteboard mode does not start.
- When the Easy Interactive Tools software is in use, whiteboard mode does not start.

If the time is incorrect on the internal storage settings for whiteboard mode, you may need to update the **Date & Time** settings in the projector's Management menu.

Parent topic: [Solving Interactive Problems](#)

Related references

[Interactive Settings - Interactive Menu](#)

[Administration Settings - Management Menu](#)

Related tasks

[Setting the Date and Time](#)

Where to Get Help (U.S. and Canada)

If you need to contact Epson for technical support services, use the following support options.

Internet Support

Visit Epson's support website at epson.com/support (U.S.) or epson.ca/support (Canada) and select your product for solutions to common problems with your projector. You can download utilities and documentation, get FAQs and troubleshooting advice, or e-mail Epson with your questions.

Speak to a Support Representative

To use the Epson PrivateLine Support service, call (800) 637-7661. This service is available for the duration of your warranty period. You may also speak with a projector support specialist by dialing (562) 276-4394 (U.S.) or (905) 709-3839 (Canada).

Support hours are Monday through Friday, 7 AM to 4 PM, Pacific Time.

Days and hours of support are subject to change without notice. Toll or long distance charges may apply.

Before you call, have the following information ready:

- Product name
- Product serial number (located on the bottom or rear of the projector, or in the menu system)
- Proof of purchase (such as a store receipt) and date of purchase
- Computer or video configuration
- Description of the problem

Purchase Supplies and Accessories

You can purchase screens, other optional accessories, and replacement parts from an Epson authorized reseller. To find the nearest reseller, call 800-GO-EPSON (800-463-7766) in the U.S. or 800-807-7766 in Canada. Or you can purchase online at epsonstore.com (U.S. sales) or epsonstore.ca (Canadian sales).

You can purchase a replacement remote control from an Epson parts distributor [here](#) (U.S. sales) or [here](#) (Canadian sales).

Parent topic: [Solving Problems](#)

Related references

[Projector Light Status](#)

Technical Specifications

These sections list the technical specifications of your projector.

[General Projector Specifications](#)

[Projector Light Source Specifications](#)

[Interactive Pen Specifications](#)

[Touch Unit Specifications](#)

[Remote Control Specifications](#)

[Projector Dimension Specifications](#)

[Projector Electrical Specifications](#)

[Projector Environmental Specifications](#)

[Projector Safety and Approvals Specifications](#)

[Safety and Approvals Specifications for Latin America](#)

[Supported Video Display Formats](#)

[USB Display System Requirements](#)

General Projector Specifications

Type of display	Poly-silicon TFT active matrix
Native resolution	1080p (1366 × 768 × 2)
	Note: Pixel shifting technology achieves Full HD resolution on screen.
Lens	F=1.5 Focal length: 3.9 mm
Color reproduction	Full color, up to 1.7 billion colors

Brightness	<p>Normal Light Source mode: White light output 5000 lumens (ISO 21118 standard) Color light output 5000 lumens</p> <p>Quiet or Extended Light Source mode: White light output 3500 lumens (ISO 21118 standard)</p> <p>Custom mode: White light output 3500 to 5000 lumens (ISO 21118 standard)</p> <p>Note: Color brightness (color light output) and white brightness (white light output) will vary depending on usage conditions. Color light output measured in accordance with IDMS 15.4; white light output measured in accordance with ISO 21118.</p>
Contrast ratio	Over 2,500,000:1 with Dynamic Color Mode, Normal Light Source Mode, and Wide Zoom on
Image size (in native aspect ratio)	65 inches (1.65 m) to 100 inches (2.54 m)
Projection distance (in native aspect ratio)	15.4 inches (0.39 m) to 24.1 inches (0.61 m)
Projection methods	Front, rear, wall-mounted, table-mounted, ceiling-mounted
Optical aspect ratio (width-to-height)	16:9
Focus adjustment	Manual
Zoom adjustment	Digital
Zoom ratio (Tele-to-Wide)	1.0 to 1.35
Internal sound system	8 W × 8W stereo
Noise level	36 dB (Normal or Extended Light Source Mode) 27 dB (Quiet Light Source Mode)
Keystone correction angle	± 3°

USB Type B port compatibility Two USB 2.0 compliant ports for USB display, wireless LAN module connection, interactivity, firmware update, or copying menu settings

USB Type A port compatibility Two USB 2.0 compliant ports for USB memory device, printer, Epson document camera, wireless LAN module connection, firmware update, or copying menu settings

Parent topic: [Technical Specifications](#)

Projector Light Source Specifications

Type	Laser diode
Light source output power	Up to 104.5 W
Wavelength	449 to 461 nm
Light source life (approximate)	Normal or Quiet Light Source Mode: Up to about 20000 hours Extended Light Source Mode: Up to about 30000 hours

Note: Turn off this product when not in use to prolong the life of the projector. Laser life will vary depending upon mode selected, environmental conditions, and usage. Brightness decreases over time.

Parent topic: [Technical Specifications](#)

Interactive Pen Specifications

Batteries	One AA alkaline or manganese
Size	6.3 inches (161 mm) long; diameter 0.94 inches (24 mm)
Weight (without battery)	1.06 oz (30 g)

Parent topic: [Technical Specifications](#)

Touch Unit Specifications

Technology	Infrared Laser (Class 1)
-------------------	--------------------------

Dimensions	Height: 1.58 inches (40 mm) Width: 16.6 inches (422 mm) Depth: 2.56 inches (65 mm)
Weight	21.2 oz (600 g)

Parent topic: [Technical Specifications](#)

Remote Control Specifications

Reception range	19.7 feet (6 m)
Batteries	Two alkaline or manganese AA

Parent topic: [Technical Specifications](#)

Projector Dimension Specifications

Height (excluding feet)	8.25 inches (209.5 mm)
Width	18 inches (458 mm)
Depth (excluding cable cover)	14.8 inches (375 mm)
Weight (excluding cable cover)	20.9 lb (9.5 kg)

Parent topic: [Technical Specifications](#)

Projector Electrical Specifications

Rated frequency	50/60 Hz
Power supply	100 to 240 V AC \pm 10% 3.8 to 1.7 A

Power consumption

(100 to 120 V)

Operating:

Normal or Custom Power Consumption mode: 381 W

Extended or Quiet Power Consumption mode: 270 W

Standby:

0.5 W (Communication Off), 2.0 W (Communication On)

Power consumption

(220 to 240 V)

Operating:

Normal or Custom Power Consumption mode: 366 W

Extended or Quiet Power Consumption mode: 262 W

Standby:

0.5 W (Communication Off), 2.0 W (Communication On)

Parent topic: [Technical Specifications](#)

Projector Environmental Specifications

Temperature

Operating - Single projector:

32 to 104 °F (0 to 40 °C)

Operating - Multiple projectors:

32 to 95 °F (0 to 35 °C)

Storage:

14 to 140 °F (–10 to 60 °C)

Humidity (relative, non-condensing)

Operating: 20 to 80%

Storage: 10 to 90%

Operating altitude

Up to 4921 feet (1500 m)

Up to 10000 feet (3048 m) with High Altitude Mode enabled

Parent topic: [Technical Specifications](#)

Projector Safety and Approvals Specifications

United States

FCC Part 15 Class B (DoC)

UL60950-1 2nd edition (cTUVus Mark)

Canada

ICES-003 Class B

CSA C22.2 No. 60950-1

Parent topic: [Technical Specifications](#)

Safety and Approvals Specifications for Latin America

Notice for Argentina

WLAN/Bluetooth Module Model: WLU5630B-D101(RoHS)

Brand: EPSON

 CNC ID: C-23113

Notice for Mexico

Operation is subject to the following two conditions: (1) this device may not cause harmful interference, and (2) this device must accept any interference received, including interference that may cause undesired operation of the device.

Product Model: H919/H921(BrightLink 1480Fi+/1485Fi+)

WLAN/Bluetooth Module Model: WLU5630B-D101 (RoHS)

Brand: EPSON

IFT Certification Number: RCPEPWL19-0590

Notice for Paraguay

Imported by:

Fastrax, S.A.

Av. Perú esq. Río de Janeiro, Barrios Las Mercedes, Asunción, Paraguay

Imported by:

Sol Control S.R.L.

Av. Gral. Bernardino Caballero 810 esq. Celsa Speratti, Asunción, Paraguay

Notice for Peru

Product Model: BrightLink 1480Fi+/1485Fi+

Brand: EPSON

This product uses the following WLAN/Bluetooth module:

WLAN Module Model: WLU5630B-D101(RoHS)

FCC ID: BKMAE-WLU5630

Product Manufacturer: Seiko Epson Corporation

Address: 3-3-5 Owa Suwa-shi, Nagano-Ken 392-8502, Japan

Parent topic: [Technical Specifications](#)

Supported Video Display Formats

For best results, your computer's monitor port or video card resolution should be set to display in the projector's native resolution. However, your projector includes Epson's SizeWise chip that supports other computer display resolutions, so your image will be resized to fit automatically.

Your computer's monitor port or video card refresh rate (vertical frequency) must be compatible with the projector. (See your computer or video card manual for details.)

The table here lists the compatible refresh rate and resolution for each compatible video display format.

Display format	Refresh rate (in Hz)	Resolution (in pixels)
Computer signals (analog RGB)		
VGA	60/72/75/85	640 × 480
SVGA	60/72/75/85	800 × 600
XGA	60/70/75/85	1024 × 768
WXGA	60-1	1280 × 768
	60-3	1366 × 768
	60/75/85	1280 × 800
WXGA+	60/75/85	1440 × 900
WXGA++	60	1600 × 900

Display format	Refresh rate (in Hz)	Resolution (in pixels)
SXGA1	70/75/85	1152 × 864
SXGA2	60/75/85	1280 × 960
SXGA3	60/75/85	1280 × 1024
SXGA+	60/75	1400 × 1050
WSXGA+*	60	1680 × 1050
UXGA	60	1600 × 1200
1920 × 1080	50/60	1920 × 1080
WUXGA (Reduced Blanking)	60	1920 × 1200
Composite video		
TV (NTSC, NTSC4.43)	60	720 × 480
TV (SECAM)	50	720 × 576
TV (PAL, N-PAL)	50	720 × 576
TV (PAL, M-PAL)	60	720 × 576
Component video		
SDTV (480p)	59.94	720 × 480
SDTV (576p)	50	720 × 576
HDTV (720p)	50/59.94/60	1280 × 720
HDTV (1080p)	50/59.94/60	1920 × 1080
HDMI/HDBaseT Control input signals		
VGA	60	640 × 480
SVGA	60	800 × 600
XGA	60	1024 × 768
WXGA	60	1280 × 800
	60	1366 × 768
WXGA+	60	1440 × 900
WXGA++	60	1600 × 900

Display format	Refresh rate (in Hz)	Resolution (in pixels)
WSXGA+	60	1680 × 1050
SXGA2	60	1280 × 960
SXGA3	60	1280 × 1024
SXGA+	60	1400 × 1050
UXGA	60	1600 × 1200
1920 × 1080	50/60	1920 × 1080
WUXGA (Reduced Blanking)	60	1920 × 1200
QXGA	60	2048 × 1536
WQHD	60	2560 × 1440
WQXGA (Reduced Blanking)	60	2560 × 1600
SDTV (480i/480p)	59.94	720 × 480
SDTV (576i/576p)	50	720 × 576
HDTV (720p)	50/59.94/60	1280 × 720
HDTV (1080i)	50/59.94/60	1920 × 1080
HDTV (1080p)	23.98/24/29.97/30/50/59.94/60	1920 × 1080
4K	23.98/24/25/29.97/30/50/59.94/60	3840 × 2160
4K (SMPTE)	23.98/24/50/59.94/60	4096 × 2160
Unique Aspect (2 projectors connected by a daisy chain)		
Unique Aspect (16:6)	60	1920 × 720
Unique Aspect (21:9)	60	1920 × 810
3240 × 1080	60	3240 × 1080

* **Wide** resolution only

Parent topic: [Technical Specifications](#)

USB Display System Requirements

Your computer system must meet the system requirements here to use the projector's USB Display software.

Requirement	Windows	Mac
Operating system	Windows 7 Ultimate, Enterprise, Professional, and Home Premium (32- and 64-bit); Home Basic and Starter (32-bit)	OS X 10.11.x (64-bit), macOS 10.12.x (64-bit), macOS 10.13.x (64-bit), macOS 10.14.x (64-bit), and macOS 10.15.x (64-bit)
	Windows 8.x, Pro, and Enterprise (32- and 64-bit)	
	Windows 10 Home, Pro, and Enterprise (32- and 64-bit)	
CPU	Intel Core2 Duo or faster (Intel Core i3 or faster recommended)	Intel Core2 Duo or faster (Intel Core i5 or faster recommended)
Memory	2GB or more (4GB or more recommended)	
Hard disk space	20MB or more	
Display	Resolution between 640 × 480 and 1920 × 1200, 16-bit color or greater	

Parent topic: [Technical Specifications](#)

Related references

[Input Signal Settings - Signal I/O Menu](#)

Notices

Check these sections for important notices about your projector.

[Recycling \(U.S. and Canada\)](#)

[Important Safety Information](#)

[Laser Safety Information](#)

[Laser Light Source Warning](#)

[Important Safety Instructions](#)

[List of Safety Symbols \(corresponding to IEC60950-1 A2\)](#)

[FCC Compliance Statement](#)

[Binding Arbitration and Class Waiver](#)

[Trademarks](#)

[Copyright Notice](#)

Recycling (U.S. and Canada)

Epson offers a recycling program for end of life products. Please go to [this site](#) for information on how to return your products for proper disposal.

Parent topic: [Notices](#)

Important Safety Information

Caution: Never look into the projector lens when the laser is turned on; the bright light can damage your eyes. Never let children look into the lens when it is on. Never open any cover on the projector, except the filter covers. Dangerous electrical voltages inside the projector can severely injure you. Except as specifically explained in this *User's Guide*, do not attempt to service this product yourself. Refer all servicing to qualified service personnel.

Warning: The projector and its accessories come packaged in plastic bags. Keep plastic bags away from small children to avoid any risk of suffocation.

Parent topic: [Notices](#)

Laser Safety Information

This projector is a Class 2 laser product that complies with the IEC/EN60825-1:2007 international standard for lasers. Follow these safety instructions when using the projector.

Warning: Possibly hazardous optical radiation emitted from this product. Do not look at operating light source. Eye injury may result.

- If an error occurs in the projector or Touch Unit, turn off the power and unplug the projector and Touch Unit immediately. Continuing to use the projector or Touch Unit could result in an electric shock, fire, or visual impairment. Contact Epson support.
- Do not attempt to disassemble or modify the projector or Touch Unit. The projector contains a high-power laser component. Serious injury could result.
- Do not look into the lens during projection. Also, do not look into the lens using optical devices, such as a magnifying glass or telescope. This could cause visual impairment.
- Do not place flammable objects in front of the lens. Objects could catch fire.
- When turning on the projector at a distance using the remote control, make sure no one is looking into the lens.
- Do not allow small children to operate the projector. Children must be accompanied by an adult.
- Do not apply optical devices, such as a magnifying glass or reflector, to the projected image. Using the projector may result in physical harm, fire, or an accident.
- Do not block the light from the lens during projection. The high temperature in this area could cause burns, fire, or other damage. The lens may overheat due to the reflected light and could cause the projector to malfunction.
- Before using the projector, make sure there is nothing in the area that could reflect the projected image.
- When disposing of the projector, do not disassemble it. Dispose of the projector in accordance with your local or national laws and regulations.

Labels are attached to the projector to indicate it is a Class 2 laser product and complies with FDA performance standards for laser products except for deviations pursuant to Laser Notice No. 50, dated June 24, 2007:

- **Inside**



- Top/Side

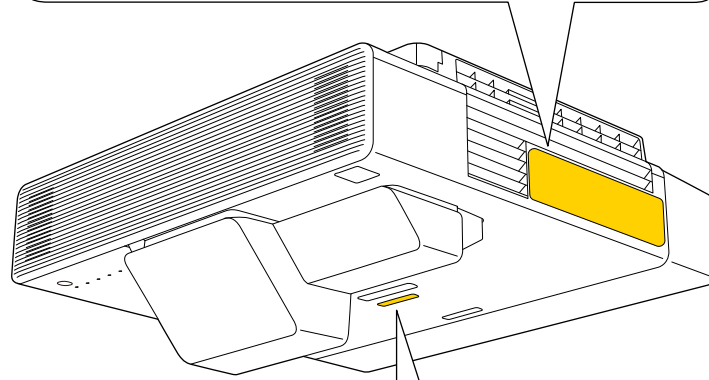

• Top

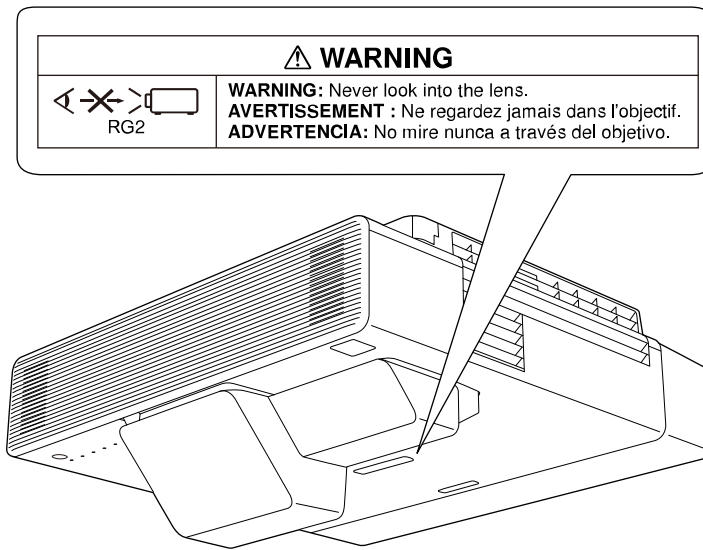

Parent topic: [Notices](#)

Laser Light Source Warning

Refer to the table here for the Exposure Hazard Values (EHV) in accordance with the IEC62471-2:2009 standard. The EHV indicates the hazard level for objects in front of the light source for 0.25 seconds at a distance of 7.9 inches (20 cm). The higher the value, the greater the hazard level.

Exposure Hazard Value	0.68
-----------------------	------

Parent topic: [Notices](#)

Important Safety Instructions

Follow these safety instructions when setting up and using the projector:

- Do not look into the lens when the projector is on. The bright light can damage your eyes. Avoid standing in front of the projector so the bright light does not shine into your eyes.
- Do not place any flammable objects in front of the projector lens, otherwise, a fire may occur.

- Do not touch the lens with bare hands.
- Do not place the projector on an unstable cart, stand, or table or on a surface that is unable to support its weight. Otherwise, it could fall or topple causing an accident and injury.
- If you use the projector tilted at an angle of more than 3°, it could be damaged and cause an accident.
- If the projector is mounted on a ceiling or wall, it should be installed by qualified technicians using mounting hardware designed for use with this projector. When installing the projector in a high position, take measures to prevent it from falling by using wires to ensure safety in an emergency, such as an earthquake, and to prevent accidents. If the projector is not installed correctly, the projector could fall. This may result in injury or accidents. Contact your dealer to carry out the installation work.
- Failure to install the ceiling mount and projector may cause the projector to fall. After installing the specific Epson mount that supports your projector, make sure you secure the mount to all of the projector's ceiling mount fixing points. Also, secure the projector and the mounts using wire that is strong enough to hold their weight.
- Do not install in locations where salt damage could occur, or in locations subject to corrosive gas such as sulphuric gas from hot springs. Otherwise, corrosion could cause the projector to fall. It could also cause the projector to malfunction.
- When installing or adjusting a ceiling or wall mount, do not use adhesives to prevent the screws from loosening and do not use oils or lubricants. This may cause the projector case to crack and the projector to fall from its ceiling mount. This could cause serious injury to anyone under the mount and could damage the projector.
- Do not install the projector in locations exposed to high humidity and dust, such as on a kitchen counter, in the kitchen, or near a humidifier, or in locations exposed to oil smoke or steam. Doing so could cause fire or electric shock.

Examples of environments that could cause the projector to fall due to case deterioration:

- Locations subject to excessive smoke or airborne oil particles, such as factories or kitchens
- Locations containing volatile solvents or chemicals, such as factories or laboratories
- Locations where the projector could be subjected to detergents or chemicals, such as factories or kitchens
- Locations in which aroma oils are often used, such as relaxation rooms
- Near devices that produce excessive smoke, airborne oil particles, or foam at events
- Do not use the projector near water, sources of heat, high-voltage electrical wires, or sources of magnetic fields.
- Use the type of power source indicated on the projector. Use of a different power source may result in fire or electric shock. If you are not sure of the power available, consult your dealer or power company.

- Place the projector near a wall outlet where the plug can be easily unplugged.
- Take the following precautions when handling the plug: Do not hold the plug with wet hands. Do not insert the plug into a dusty outlet. Insert the plug firmly into the outlet. Do not pull the power cord when disconnecting the plug; always be sure to hold the plug when disconnecting it. Do not overload wall outlets, extension cords, or power strips. Failure to comply with these precautions could result in fire or electric shock.
- Do not place the projector where the cord can be walked on. This may result in fraying or damage to the plug.
- Unplug the projector from the wall outlet and allow to cool before cleaning. Use a dry cloth (or, for stubborn dirt or stains, a moist cloth that has been wrung dry) for cleaning. Do not use liquid or aerosol cleaners, any sprays containing flammable gas, or solvents such as alcohol, paint thinner, or benzene.
- Do not block the slots and openings in the projector case. They provide ventilation and prevent the projector from overheating. If the vents are covered, the internal temperature could rise and cause a fire. Do not place the projector in locations subject to high temperatures, such as near heating equipment. Do not operate the projector on a sofa, rug, or other soft surface, or set it on top of loose papers. Do not cover the projector with a blanket, curtain, or tablecloth. If you are setting up the projector near a wall, leave at least 19.7 inches (50 cm) of space between the wall and the projector.
- Do not operate the projector in a closed-in cabinet unless proper ventilation is provided.
- Never allow objects of any kind to enter any openings in the projector. Do not leave objects, especially flammable objects, near the projector. Do not place any containers of liquid on top of the unit. Never spill liquid of any kind into the projector.
- Do not insert or drop metal, flammable, or foreign objects into the projector's vents or openings nor leave them nearby. Doing so may result in fire, electric shock, or burns.
- If you are using two or more projectors side-by-side (BrightLink 1485Fi), leave enough space between the projectors to allow for proper ventilation.
- You may need to clean the air filter and vent. A clogged air filter or vent can block ventilation needed to cool the projector. Do not use canned air, or the gases may leave a residue.
- Do not use or store the projector in locations where it will be subject to dust or dirt. Otherwise, the quality of the projected image may decline, or the air filter may become clogged, resulting in a malfunction or fire.
- Follow the maintenance schedule for this projector. If the interior of the projector has not been cleaned for a long time, dust may build up, which could cause fire or electric shock. Replace your air filter periodically and contact your dealer to clean the interior of the projector, as needed.
- Do not store the projector outdoors for an extended length of time.

- Except as specifically explained in this manual, do not attempt to service this product yourself. Refer all servicing to qualified personnel. Opening or removing covers may expose you to dangerous voltages and other hazards.
- Never open any covers on the projector except as specifically explained in this manual. Never attempt to disassemble or modify the projector (including consumables). Refer all repairs to qualified service personnel. Electrical voltages inside the projector can cause serious injury.
- Unplug the projector from the wall outlet and refer servicing to qualified service personnel under the following conditions: if it does not operate normally when you follow the operating instructions, or exhibits a distinct change in performance; if smoke, strange odors, or strange noises come from the projector; if the power cord or plug is damaged or frayed; if liquid or foreign objects get inside the projector, or if it has been exposed to rain or water; if it has been dropped or the housing has been damaged. Continuing to use the projector under these conditions may result in fire or electric shock.
- Do not touch the plug during an electrical storm. Otherwise, you may receive an electric shock.
- Unplug the projector when it will not be used for extended periods. The insulation may deteriorate, which may result in fire.
- Do not use the projector where it may be exposed to rain, water, or excessive humidity.
- Do not use or store the projector where it may be exposed to smoke, steam, corrosive gases, excessive dust, vibration, or shock. Doing so may result in malfunction, electric shock, and fire.
- Do not use or store the projector in places where smoke from oil or cigarettes may be present, as it can adversely affect the quality of the projected images.
- Do not use the projector where flammable or explosive gases may be present. The inside of the projector can get very hot during use and the gases may ignite, resulting in a fire.
- Do not use or store the projector or remote control in a hot location, such as near a heater, in direct sunlight, or in a closed vehicle. Thermal deformation or technical malfunction may occur, which may result in a fire.
- Check the specifications for the power cable. Using an inappropriate power cable could result in fire or electric shock. The power cable supplied with the projector is intended to comply with power supply requirements for the country of purchase. If you use the projector in the country where it was purchased, only use the power cable that came with the projector.
- If you use the projector in a country other than where you purchased it, use the correct power cord for that country.
- Do not stand on the projector or place heavy objects on it. You may fall over, resulting in injury and damage to the projector.
- Do not use the projector outside of the required temperature range below:

32 to 104 °F (0 to 40 °C) at an altitude of 7500 feet (2286 m) or less, or 32 to 95 °F (0 to 35 °C) at an altitude of 7500 to 10000 feet (2286 to 3048 m)

When using multiple projectors at the same time (BrightLink 1485Fi):

32 to 95 °F (0 to 35 °C) at an altitude of 7500 feet (2286 m) or less, or 32 to 86 °F (0 to 30 °C) at an altitude of 7500 to 10000 feet (2286 m to 3048 m)

Doing so may cause an unstable display and could lead to projector damage. Do not use or store the projector where it may be exposed to sudden changes in temperature.

- Do not use or store the projector in places where it might be subjected to high and low extremes of temperature.
- Do not store the projector outside of the required temperature range of 14 to 140 °F (–10 to 60 °C) or in direct sunlight for long periods of time. Doing so may cause damage to the case.
- Do not place anything that can become warped or damaged by heat near the exhaust vents. Do not bring your hands or face close to the vents while projection is in progress. Do not bring your face close to the projector while it is in use.
- Before you move the projector, make sure its power is turned off, the plug is disconnected from the outlet, and all cables are disconnected. Fire or electric shock may result.
- Do not place the source of an open flame, such as a lit candle, on or near the projector.
- During projection, do not block the light from the projector with a book or other objects. If the light from the projector is blocked, the area on which the light shines becomes hot which could cause it to melt, burn, or start a fire. Also, the lens may get hot due to the reflected light which could cause the projector to malfunction. To stop projection, use the A/V Mute function, or turn off the projector.
- Do not modify the power cord. Do not place heavy objects on top of the power cord or bend, twist, or pull it excessively. Keep the power cord away from hot electrical appliances. Do not use the power cord if it is damaged. Fire or electric shock may result. Contact your dealer if the cable becomes damaged.
- Always lower the volume before turning off the projector. Turning on the projector with the volume too high can damage your ears.
- When a still image is displayed for a long time, image retention may occur on the screen. Do not display images in the exact same position for long periods.
- Always attach the lens cover to the lens when not using the projector to prevent the lens from becoming dirty or damaged.
- Do not store the interactive pens or the batteries in a hot location, such as near a heater, in direct sunlight, or in a closed vehicle. Thermal deformation or technical malfunction may occur, which may result in a fire.

- Remove the batteries from the interactive pens if you will not be using the pens for a long time.
- Incorrect battery usage may cause leakage of battery fluid and battery rupture, which could result in fire, injury, or corrosion. When replacing batteries, take the following precautions: insert batteries so that the polarities are correct; do not use batteries of different types or mix old and new batteries; do not use any batteries other than those specified; if batteries leak, wipe away battery fluid with a soft cloth; if battery fluid gets on your hands, wash them immediately; replace the batteries as soon as they run out; remove the batteries if you will not be using the projector for a long period of time; do not expose batteries to heat or flame and do not put them in water; dispose of used batteries according to local regulations; keep batteries out of the reach of children. Batteries are choking hazards and are very dangerous if swallowed.

[Restriction of Use](#)

Parent topic: [Notices](#)

Restriction of Use

When this product is used for applications requiring high reliability/safety such as transportation devices related to aviation, rail, marine, automotive; disaster prevention devices; various safety devices; or functional/precision devices, you should use this product only after giving consideration to including fail-safes and redundancies into your design to maintain safety and total system reliability.







Because this product was not intended for use in applications requiring extremely high reliability/safety such as aerospace equipment, main communication equipment, nuclear power control equipment, or medical equipment related to direct medical care, please make your own judgment on this product's suitability after a full evaluation.







Parent topic: [Important Safety Instructions](#)







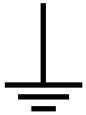

List of Safety Symbols (corresponding to IEC60950-1 A2)







The following table lists the meaning of the safety symbols labeled on the equipment.

No.	Symbol	Approved Standards	Description
1		IEC60417 No.5007	"ON" (power) To indicate connection to the mains.

No.	Symbol	Approved Standards	Description
2		IEC60417 No.5008	"OFF" (power) To indicate disconnection from the mains.
3		IEC60417 No.5009	Stand-by To identify the switch or switch position by means of which part of the equipment is switched on in order to bring it into the stand-by condition.
4		ISO7000 No.0434B, IEC3864-B3.1	Caution To identify general caution when using the product.
5		IEC60417 No.5041	Caution, hot surface To indicate that the marked item can be hot and should not be touched without taking care.
6		IEC60417 No.6042 ISO3864-B3.6	Caution, risk of electric shock To identify equipment that has risk of electric shock.
7		IEC60417 No.5957	For indoor use only To identify electrical equipment designed primarily for indoor use.
8		IEC60417 No.5926	Polarity of DC power connector To identify the positive and negative connections (the polarity) on a piece of equipment to which a DC power supply may be connected.

No.	Symbol	Approved Standards	Description
9		—	Polarity of DC power connector To identify the positive and negative connections (the polarity) on a piece of equipment to which a DC. power supply may be connected.
10		IEC60417 No.5001B	Battery, general On battery powered equipment. To identify a device for instance a cover for the battery compartment, or the connector terminals.
11		IEC60417 No.5002	Positioning of cell To identify the battery holder itself and to identify the positioning of the cell(s) inside the battery holder.
12		—	Positioning of cell To identify the battery holder itself and to identify the positioning of the cell(s) inside the battery holder.
13		IEC60417 No.5019	Protective earth To identify any terminal which is intended for connection to an external conductor for protection against electric shock in case of a fault, or the terminal of a protective earth electrode.
14		IEC60417 No.5017	Earth To identify an earth (ground) terminal in cases where neither the symbol No.13 is explicitly required.
15		IEC60417 No.5032	Alternating current To indicate on the rating plate that the equipment is suitable for alternating current only; to identify relevant terminals.

No.	Symbol	Approved Standards	Description
16		IEC60417 No.5031	Direct current To indicate on the rating plate that the equipment is suitable for direct current only; to identify relevant terminals.
17		IEC60417 No.5172	Class II equipment To identify equipment meeting the safety requirements specified for Class II equipment according to IEC 61140.
18		ISO 3864	General prohibition To identify actions or operations that are prohibited.
19		ISO 3864	Contact prohibition To indicate injury that could occur due to touching a specific part of the equipment.
20		—	Never look into the optical lens while the projector is on.
21		—	To indicate that the marked item don't place anything on projector.
22		ISO3864 IEC60825-1	Caution, laser radiation To indicate the equipment has a laser radiation part.
23		ISO 3864	Disassembly prohibition To indicate a risk of injury, such as electric shock, if the equipment is disassembled.

No.	Symbol	Approved Standards	Description
24		IEC60417 No. 5266	Standby, partial standby To indicate that part of the equipment is in the ready status.
25		ISO3864 IEC60417 No. 5057	Caution, movable parts To indicate that you must keep away from movable parts according to protection standards.
27		IEC 60417-6056	Caution (movable fan blades) To indicate that you must keep away from the blades of the movable fan according to protection standards.
28		IEC 60417-6043	Caution (sharp corners) To indicate that you must not touch the sharp corners of the product according to protection standards.
29		—	Never look into the projection lens while the projector is on.
30		ISO7010 No. W027	Warning, light emission (UV, visible light, IR and so on) To indicate that you must be careful not to injure your eyes or skin when near light emitting sections.
31		IEC60417 No. 5109	Not to be used in residential areas To indicate that the electrical equipment/device is not suitable for use in residential area.

Parent topic: [Notices](#)

FCC Compliance Statement

For United States Users

This equipment has been tested and found to comply with the limits for a Class B digital device, pursuant to Part 15 of the FCC Rules. These limits are designed to provide reasonable protection against harmful interference in a residential installation. This equipment generates, uses, and can radiate radio frequency energy and, if not installed and used in accordance with the instructions, may cause harmful interference to radio communications. However, there is no guarantee that interference will not occur in a particular installation. If this equipment does cause interference to radio and television reception, which can be determined by turning the equipment off and on, the user is encouraged to try to correct the interference by one or more of the following measures:

- Reorient or relocate the receiving antenna.
- Increase the separation between the equipment and receiver.
- Connect the equipment into an outlet on a circuit different from that to which the receiver is connected.
- Consult the dealer or an experienced radio/TV technician for help.

This device complies with part 15 of the FCC Rules. Operation is subject to the following two conditions: (1) This device may not cause harmful interference, and (2) this device must accept any interference received, including interference that may cause undesired operation.

WARNING

The connection of a non-shielded equipment interface cable to this equipment will invalidate the FCC Certification or Declaration of this device and may cause interference levels which exceed the limits established by the FCC for this equipment. It is the responsibility of the user to obtain and use a shielded equipment interface cable with this device. If this equipment has more than one interface connector, do not leave cables connected to unused interfaces. Changes or modifications not expressly approved by the manufacturer could void the user's authority to operate the equipment.

For Canadian Users

CAN ICES-3(B)/NMB-3(B)

Parent topic: [Notices](#)

Binding Arbitration and Class Waiver

1. DISPUTES, BINDING INDIVIDUAL ARBITRATION, AND WAIVER OF CLASS ACTIONS AND CLASS ARBITRATIONS

1.1 Disputes. The terms of this Section 1 shall apply to all Disputes between you and Epson. The term "Dispute" is meant to have the broadest meaning permissible under law and includes any dispute, claim, controversy or action between you and Epson arising out of or relating to this Agreement, Epson branded products (hardware and including any related software), or other transaction involving you and Epson, whether in contract, warranty, misrepresentation, fraud, tort, intentional tort, statute, regulation, ordinance, or any other legal or equitable basis. "DISPUTE" DOES NOT INCLUDE IP CLAIMS, or more specifically, a claim or cause of action for (a) trademark infringement or dilution, (b) patent infringement, (c) copyright infringement or misuse, or (d) trade secret misappropriation (an "IP Claim"). You and Epson also agree, notwithstanding Section 1.6, that a court, not an arbitrator, may decide if a claim or cause of action is for an IP Claim.

1.2 Binding Arbitration. You and Epson agree that all Disputes shall be resolved by binding arbitration according to this Agreement. **ARBITRATION MEANS THAT YOU WAIVE YOUR RIGHT TO A JUDGE OR JURY IN A COURT PROCEEDING AND YOUR GROUNDS FOR APPEAL ARE LIMITED.**

Pursuant to this Agreement, binding arbitration shall be administered by JAMS, a nationally recognized arbitration authority, pursuant to its code of procedures then in effect for consumer related disputes, but excluding any rules that permit joinder or class actions in arbitration (for more detail on procedure, see Section 1.6 below). You and Epson understand and agree that (a) the Federal Arbitration Act (9 U.S.C. §1, et seq.) governs the interpretation and enforcement of this Section 1, (b) this Agreement memorializes a transaction in interstate commerce, and (c) this Section 1 shall survive termination of this Agreement.

1.3 Pre-Arbitration Steps and Notice. Before submitting a claim for arbitration, you and Epson agree to try, for sixty (60) days, to resolve any Dispute informally. If Epson and you do not reach an agreement to resolve the Dispute within the sixty (60) days, you or Epson may commence an arbitration. Notice to Epson must be addressed to: Epson America, Inc., ATTN: Legal Department, 3131 Katella Ave., Los Alamitos, CA 90720 (the "Epson Address"). The Dispute Notice to you will be sent to the most recent address Epson has in its records for you. For this reason, it is important to notify us if your address changes by emailing us at EAILEgal@ea.epson.com or writing us at the Epson Address above. Notice of the Dispute shall include the sender's name, address and contact information, the facts giving rise to the Dispute, and the relief requested (the "Dispute Notice"). Following receipt of the Dispute Notice, Epson and you agree to act in good faith to resolve the Dispute before commencing arbitration.

1.4 Small Claims Court. Notwithstanding the foregoing, you may bring an individual action in the small claims court of your state or municipality if the action is within that court's jurisdiction and is pending only in that court.

1.5 WAIVER OF CLASS ACTIONS AND CLASS ARBITRATIONS. YOU AND EPSON AGREE THAT EACH PARTY MAY BRING DISPUTES AGAINST THE OTHER PARTY ONLY IN AN INDIVIDUAL CAPACITY, AND NOT AS A PLAINTIFF OR CLASS MEMBER IN ANY CLASS OR REPRESENTATIVE PROCEEDING, INCLUDING WITHOUT LIMITATION FEDERAL OR STATE CLASS ACTIONS, OR CLASS ARBITRATIONS. CLASS ACTION LAWSUITS, CLASS-WIDE ARBITRATIONS, PRIVATE ATTORNEY-GENERAL ACTIONS, AND ANY OTHER PROCEEDING WHERE SOMEONE ACTS IN A REPRESENTATIVE CAPACITY ARE NOT ALLOWED. ACCORDINGLY, UNDER THE ARBITRATION PROCEDURES OUTLINED IN THIS SECTION, AN ARBITRATOR SHALL NOT COMBINE OR CONSOLIDATE MORE THAN ONE PARTY'S CLAIMS WITHOUT THE WRITTEN CONSENT OF ALL AFFECTED PARTIES TO AN ARBITRATION PROCEEDING.

1.6 Arbitration Procedure. If you or Epson commences arbitration, the arbitration shall be governed by the rules of JAMS that are in effect when the arbitration is filed, excluding any rules that permit arbitration on a class or representative basis (the "JAMS Rules"), available at <http://www.jamsadr.com> or by calling 1-800-352-5267, and under the rules set forth in this Agreement. All Disputes shall be resolved by a single neutral arbitrator, and both parties shall have a reasonable opportunity to participate in the selection of the arbitrator. The arbitrator is bound by the terms of this Agreement. The arbitrator, and not any federal, state or local court or agency, shall have exclusive authority to resolve all disputes arising out of or relating to the interpretation, applicability, enforceability or formation of this Agreement, including any claim that all or any part of this Agreement is void or voidable. Notwithstanding this broad delegation of authority to the arbitrator, a court may determine the limited question of whether a claim or cause of action is for an IP Claim, which is excluded from the definition of "Disputes" in Section 1.1 above. The arbitrator shall be empowered to grant whatever relief would be available in a court under law or in equity. The arbitrator may award you the same damages as a court could, and may award declaratory or injunctive relief only in favor of the individual party seeking relief and only to the extent necessary to provide relief warranted by that party's individual claim. In some instances, the costs of arbitration can exceed the costs of litigation and the right to discovery may be more limited in arbitration than in court. The arbitrator's award is binding and may be entered as a judgment in any court of competent jurisdiction.

You may choose to engage in arbitration hearings by telephone. Arbitration hearings not conducted by telephone shall take place in a location reasonably accessible from your primary residence, or in Orange County, California, at your option.

a) Initiation of Arbitration Proceeding. If either you or Epson decides to arbitrate a Dispute, both parties agree to the following procedure:

(i) Write a Demand for Arbitration. The demand must include a description of the Dispute and the amount of damages sought to be recovered. You can find a copy of a Demand for Arbitration at <http://www.jamsadr.com> ("Demand for Arbitration").

(ii) Send three copies of the Demand for Arbitration, plus the appropriate filing fee, to: JAMS, 500 North State College Blvd., Suite 600 Orange, CA 92868, U.S.A.

(iii) Send one copy of the Demand for Arbitration to the other party (same address as the Dispute Notice), or as otherwise agreed by the parties.

b) Hearing Format. During the arbitration, the amount of any settlement offer made shall not be disclosed to the arbitrator until after the arbitrator determines the amount, if any, to which you or Epson is entitled. The discovery or exchange of non-privileged information relevant to the Dispute may be allowed during the arbitration.

c) Arbitration Fees. Epson shall pay, or (if applicable) reimburse you for, all JAMS filings and arbitrator fees for any arbitration commenced (by you or Epson) pursuant to provisions of this Agreement.

d) Award in Your Favor. For Disputes in which you or Epson seeks \$75,000 or less in damages exclusive of attorney's fees and costs, if the arbitrator's decision results in an award to you in an amount greater than Epson's last written offer, if any, to settle the Dispute, Epson will: (i) pay you \$1,000 or the amount of the award, whichever is greater; (ii) pay you twice the amount of your reasonable attorney's fees, if any; and (iii) reimburse you for any expenses (including expert witness fees and costs) that your attorney reasonably accrues for investigating, preparing, and pursuing the Dispute in arbitration. Except as agreed upon by you and Epson in writing, the arbitrator shall determine the amount of fees, costs, and expenses to be paid by Epson pursuant to this Section 1.6d).

e) Attorney's Fees. Epson will not seek its attorney's fees and expenses for any arbitration commenced involving a Dispute under this Agreement. Your right to attorney's fees and expenses under Section 1.6d) above does not limit your rights to attorney's fees and expenses under applicable law; notwithstanding the foregoing, the arbitrator may not award duplicative awards of attorney's fees and expenses.

1.7 Opt-out. You may elect to opt-out (exclude yourself) from the final, binding, individual arbitration procedure and waiver of class and representative proceedings specified in this Agreement by sending a written letter to the Epson Address within thirty (30) days of your assent to this Agreement (including without limitation the purchase, download, installation of the Software or other applicable use of Epson Hardware, products and services) that specifies (i) your name, (ii) your mailing address, and (iii) your request to be excluded from the final, binding individual arbitration procedure and waiver of class and representative proceedings specified in this Section 1. In the event that you opt-out consistent with the procedure set forth above, all other terms shall continue to apply, including the requirement to provide notice prior to litigation.

1.8 Amendments to Section 1. Notwithstanding any provision in this Agreement to the contrary, you and Epson agree that if Epson makes any future amendments to the dispute resolution procedure and class action waiver provisions (other than a change to Epson's address) in this Agreement, Epson will obtain your affirmative assent to the applicable amendment. If you do not affirmatively assent to the applicable amendment, you are agreeing that you will arbitrate any Dispute between the parties in accordance with the language of this Section 1 (or resolve disputes as provided for in Section 1.7, if you timely elected to opt-out when you first assented to this Agreement).

1.9 Severability. If any provision in this Section 1 is found to be unenforceable, that provision shall be severed with the remainder of this Agreement remaining in full force and effect. **The foregoing shall not apply to the prohibition against class or representative actions as provided in Section 1.5. This means that if Section 1.5 is found to be unenforceable, the entire Section 1 (but only Section 1) shall be null and void.**

Parent topic: [Notices](#)

Trademarks

EPSON® and Quick Corner® are registered trademarks, Epson iProjection is a trademark, and EPSON Exceed Your Vision is a registered logomark of Seiko Epson Corporation.

PrivateLine® is a registered trademarks; SizeWise™ is a trademark; and Extra CareSM is a service mark of Epson America, Inc.

Windows is a registered trademark of Microsoft Corporation in the United States and/or other countries.

Mac, macOS, and OS X are trademarks of Apple Inc., registered in the U.S. and other countries.

Google® is a registered trademark and Android™, Google Chrome™, and Google Play™ are trademarks of Google LLC.

HDBaseT™ and the HDBaseT Alliance logo are trademarks of the HDBaseT Alliance.

Miracast® is a registered trademark of Wi-Fi Alliance®.

General Notice: Other product names used herein are for identification purposes only and may be trademarks of their respective owners. Epson disclaims any and all rights in those marks.



Parent topic: [Notices](#)

Copyright Notice

All rights reserved. No part of this publication may be reproduced, stored in a retrieval system, or transmitted in any form or by any means, electronic, mechanical, photocopying, recording, or otherwise, without the prior written permission of Seiko Epson Corporation. The information contained herein is designed only for use with this Epson product. Epson is not responsible for any use of this information as applied to other products.

Neither Seiko Epson Corporation nor its affiliates shall be liable to the purchaser of this product or third parties for damages, losses, costs, or expenses incurred by purchaser or third parties as a result of: accident, misuse, or abuse of this product or unauthorized modifications, repairs, or alterations to this product, or (excluding the U.S.) failure to strictly comply with Seiko Epson Corporation's operating and maintenance instructions.

Seiko Epson Corporation shall not be liable for any damages or problems arising from the use of any options or any consumable products other than those designated as Original Epson Products or Epson Approved Products by Seiko Epson Corporation.

This information is subject to change without notice.

[A Note Concerning Responsible Use of Copyrighted Materials](#)
[Copyright Attribution](#)

Parent topic: [Notices](#)

A Note Concerning Responsible Use of Copyrighted Materials

Epson encourages each user to be responsible and respectful of the copyright laws when using any Epson product. While some countries' laws permit limited copying or reuse of copyrighted material in certain circumstances, those circumstances may not be as broad as some people assume. Contact your legal advisor for any questions regarding copyright law.

Parent topic: [Copyright Notice](#)

Copyright Attribution

© 2021 Epson America, Inc.

10/21

CPD-57752R2

Parent topic: [Copyright Notice](#)