

## USE AND CARE GUIDE

---

### 11 INCH WHITE ROUND FLAT PANEL FIXTURE WITH SELECTABLE COLOR TEMPERATURE

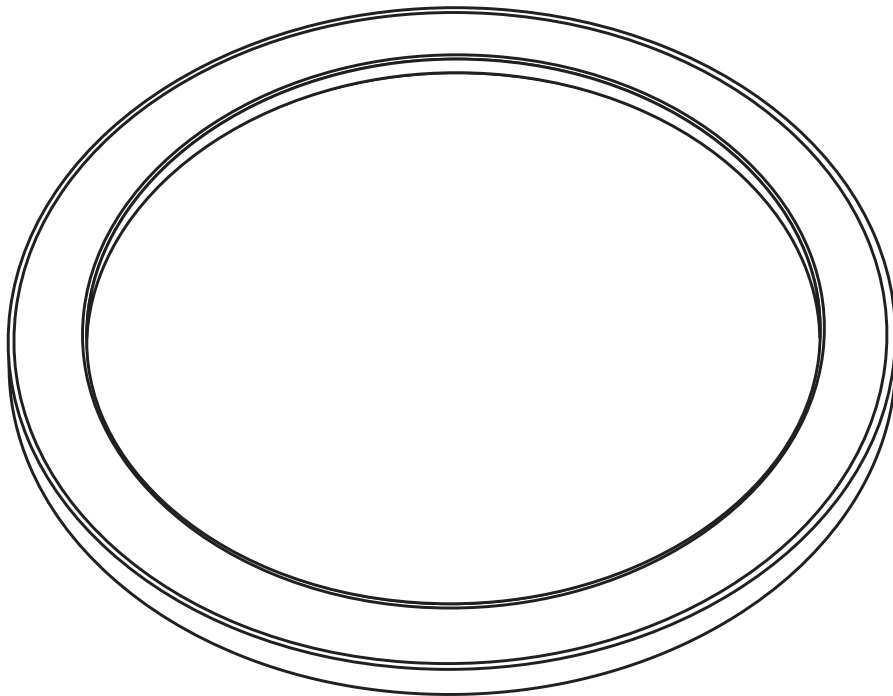

**READ BEFORE INSTALLATION**

**SAVE THESE INSTRUCTIONS**

Questions, problems, missing parts?

Before returning to store, visit [feit.com/help](http://feit.com/help) for further assistance.



# Table of Contents

Table of Contents	2
Safety Information	2
Warranty	2
Pre-Installation	3
Tools Required	3
Hardware Included	3
Installation	4-5
Changing the Color Settings	6

# Safety Information

## For your safety, always remember to:

- Turn off the power supply at the fuse or circuit breaker box before you install the fixture.
- Ground the fixture to avoid potential electric shock and to ensure reliable starting.
- Double-check all connections to be sure they are tight and correct.
- Wear rubber soled shoes and work on a sturdy wooden ladder.
- Account for small parts and destroy packing material, as these may be hazardous to children.

This fixture is designed for use in a circuit protected by a fuse or circuit breaker. It is also designed to be installed in accordance with local electrical codes. If you are unsure about your wiring, consult a certified electrician or local electrical inspector, and check your local electrical code.

## FCC STATEMENT

This device complies with part 15 of the FCC Rules. Operation is subject to the following two conditions: (1) This device may not cause harmful interference, and (2) this device must accept any interference received, including interference that may cause undesired operation. Note: This equipment has been tested and found to comply with the limits for a Class B digital device, pursuant to part 15 of the FCC Rules. These limits are designed to provide reasonable protection against harmful interference in a residential installation. This equipment generates, uses and can radiate radio frequency energy and, if not installed and used in accordance with the instructions, may cause harmful interference to radio communications. However, there is no guarantee that interference will not occur in a particular installation. If this equipment does cause harmful interference to radio or television reception, which can be determined by turning the equipment off and on, the user is encouraged to try to correct the interference by one or more of the following measures: Reorient or relocate the receiving antenna. Increase the separation between the equipment and receiver. Connect the equipment into an outlet on a circuit different from that to which the receiver is connected. Consult the dealer or an experienced radio/TV technician for help. Any changes or modifications not expressly approved by the manufacturer could void the user's authority to operate the equipment. Feit Electric Company, 4901 Gregg Road, Pico Rivera, CA 90660. www.feit.com. CAN ICES-005 (B).

 **WARNING: RISK OF SHOCK.** House electric current can cause painful shock or serious injury unless handled properly.

 **CAUTION:** Turn off the main power at the circuit breaker before installing the fixture, in order to prevent possible shock.

**NOTICE:** All electrical connections must be in accordance with local and National Electrical Code (N.E.C.) standards. If you are unfamiliar with proper electrical wiring connections obtain the services of a certified electrician.

Remove the fixture and the mounting package from the box and make sure that no parts are missing by referencing the illustrations on the installation instructions.

 **WARNING:** Risk of fire. Use only on 120 volt 60Hz circuits. Suitable for damp locations. Before installing your lighting fixture, thoroughly review enclosed installation manual. If you do not have sufficient electrical wiring experience, please refer to a do-it-yourself wiring handbook or have your fixture installed by a certified electrician. All electrical connections must be in accordance with Local and National Electrical Code (NEC) Standards. Reliable operating temperature is 0°F –120°F. If flickering occurs in low level dimming, increase light level. Compatible with most dimmers including Leviton 6681-IW, Lutron S-600P and Lutron DVCL-153. Dimmable to 10% with most dimmers.

**Supplier's Declaration of Conformity:**  
47 CFR § 2.1077 Compliance Information  
**Responsible Party:**  
Feit Electric Company  
4901 Gregg Road, Pico Rivera, CA 90660 USA  
562-463-2852  
**Unique Identifier:**74210/6WY/BK

# Limited Warranty

This product is warranted to be free from defects in workmanship and materials for up to 5 years from date of purchase. If the product fails within the warranty period, please contact Feit Electric at info@feit.com, visit feit.com/contact-us or call 1-866-326-BULB (2852) for instructions on replacement or refund. REPLACEMENT OR REFUND IS YOUR SOLE REMEDY. EXCEPT TO THE EXTENT PROHIBITED BY APPLICABLE LAW, ANY IMPLIED WARRANTIES ARE LIMITED IN DURATION TO THE DURATION OF THIS WARRANTY. LIABILITY FOR INCIDENTAL OR CONSEQUENTIAL DAMAGES IS HEREBY EXPRESSLY EXCLUDED. Some states and provinces do not allow the exclusion of incidental or consequential damages, so the above limitation or exclusion may not apply to you. This warranty gives you specific legal rights, and you may also have other rights which vary from state to state or province to province.

# Pre-Installation



NOTE: Hardware not shown to actual size.

## TOOLS REQUIRED



Phillips  
Screwdriver

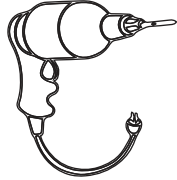

Power Drill



1/8 in. Drill Bit

## PACKAGE CONTENTS

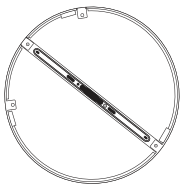

AA

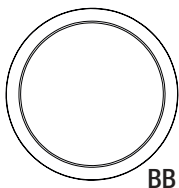

BB



CC

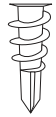

DD



EE



FF

Part	Description	Quantity
AA	Mounting Bracket	1
BB	Lamp Unit	1
CC	Junction Box Screws	2
DD	Plastic Anchors	2
EE	Anchor Screws	2
FF	Wire Connectors	3

## LIGHTING DISTRIBUTION

DISTANCE	CENTER BEAM (FOOT CANDLES)	BEAM DIAMETER
3 FT.	42	9.2 FT.
5 FT.	15	15 FT.
8 FT.	6	25 FT.
15 FT.	1.7	46 FT.
BEAM SPREAD = 114°		CD @ CB : 382.1

# Installation

## 1 Turning Off the Power

- Turn the power OFF at the switch and fusebox or the circuit breaker.

## 2 Removing the fixture from the mounting bracket

- Twist and unlock the mounting bracket (AA) from the round LED flat panel (BB) fixture to remove.

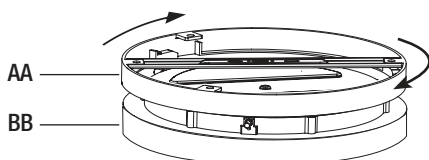

## 3 Identifying the wires

- Identify the wires (Black-line voltage, White-neutral, ground) from the ceiling and make them accessible for easy connections.

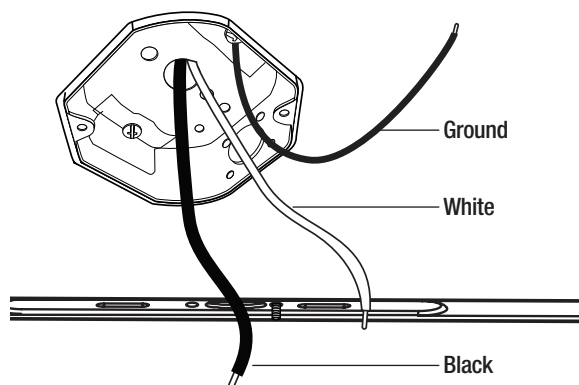

## 4 Attaching the mounting bracket to the junction box in the ceiling

- Secure the bracket (AA) to the junction box using the junction box screws (CC) provided.

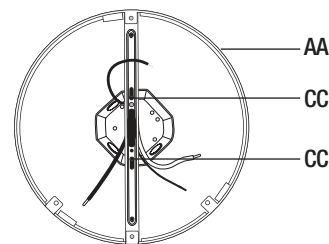

**NOTE:** If securing the bracket with anchors is also desired, follow the remaining steps in step 4. Otherwise, proceed to step 5.

- Use a pencil to mark the two hole positions for the plastic anchors (DD) going in the ceiling.

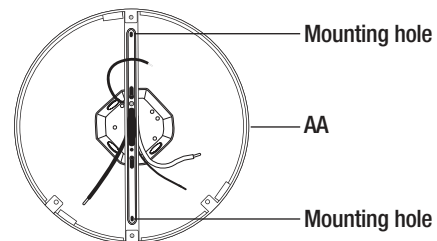

- Remove the bracket (AA) and install plastic anchors (DD) at the marked locations. Use a 1/8 in. drill bit to make a hole and insert a plastic anchor (DD) into each hole by tapping gently.

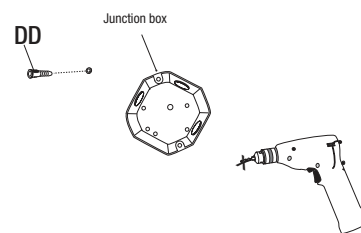

- Screw the mounting bracket (AA) into the junction box using junction box screw (CC) and into the plastic anchor installed in the ceiling using anchor screw (EE) until secure.

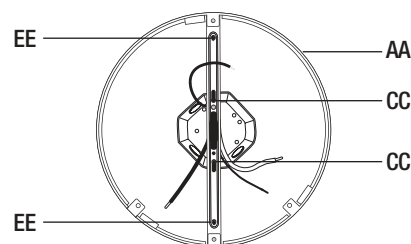

## Installation (continued)

### 5 Connecting the support wire

- Hook the support wire installed in the fixture to the mounting bracket (AA) while you make electrical connections.

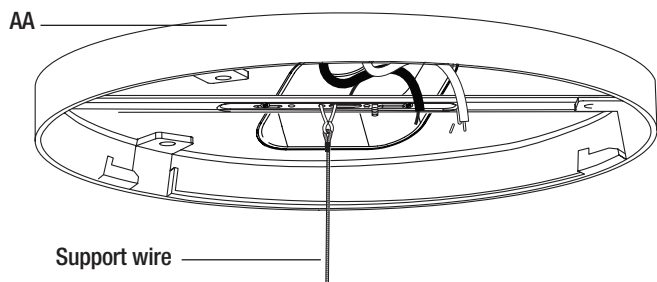

### 6 Connecting the wires

- Feed the lamp unit wires through the mounting bracket (AA) center hole. Use the wire connectors (FF) to connect the three wires coming from the junction box as shown (Black-line voltage, White-neutral, Green/Copper - Ground).

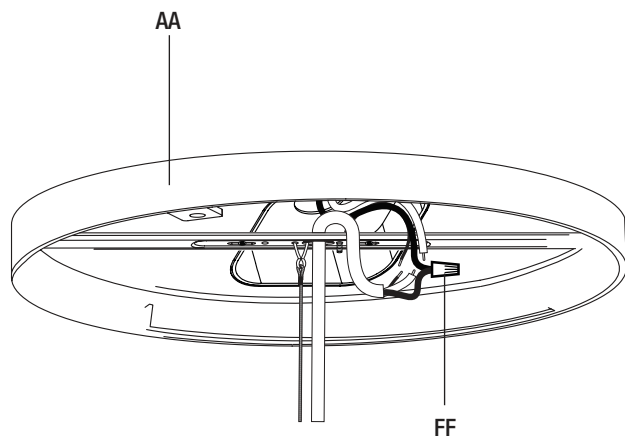

### 7 Attaching the fixture to the mounting bracket



**NOTE:** Before attaching the fixture, select the preferred color temperature on the back of the fixture. See “Changing Color Settings” for details.

- Match up the alignment arrows (1-1) indicated on the mounting bracket (AA) and the lamp unit (BB). Raise the lamp unit into the mounting bracket (AA).

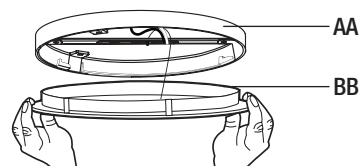

- Twist and lock the lamp unit (BB) into the mounting bracket (AA) in the “Lock direction” position to match the alignment arrows (1-2).

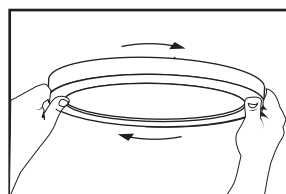
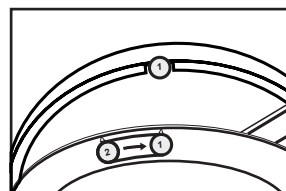

- Once locked in place, remove the stickers and gently align the lamp unit (AA) and mounting bracket (BB) for the best fit.

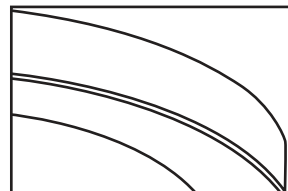

## Changing Color Settings

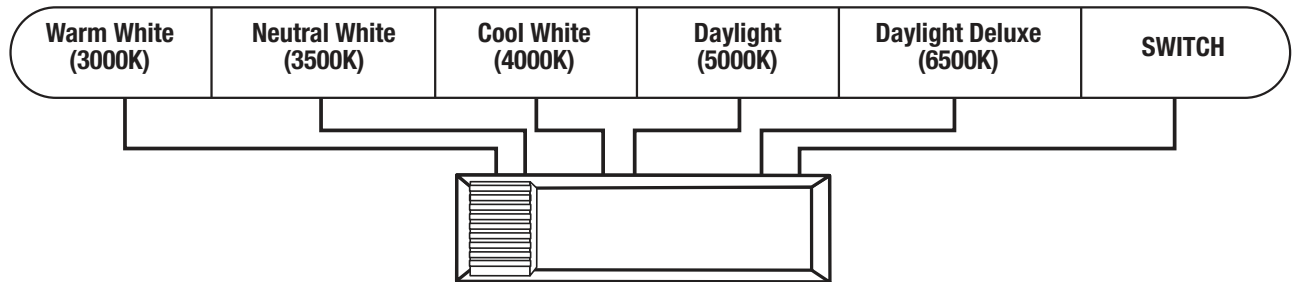

1. When the slide switch is set to 3000K, the color temperature is set to Warm White.
2. When the slide switch is set to 3500K, the color temperature is set to Neutral White.
3. When the slide switch is set to 4000K, the color temperature is set to Cool White.
4. When the slide switch is set to 5000K, the color temperature is set to Daylight.
5. When the slide switch is set to 6500K, the color temperature is set to Daylight Deluxe.
6. When the slide switch is set to SWITCH, the color temperature can be changed from 3000K, 3500K, 4000K, 5000K and 6500K with your existing light switch.
7. To change color temperatures using your existing light switch:
  - A. Set the slide switch on the back of the fixture to SWITCH.
  - B. Toggle your light switch ON and OFF within 0.5-3 seconds to cycle through the 5 different color temperatures.
  - C. If the fixture is left OFF for over 10 seconds then turned ON, the fixture will remember the last color temperature selected and will display that color when turned on again.
8. Reset function is used when operating multiple color selectable lighting products from the same light switch. In the event multiple fixtures are not displaying the same color at the same time, the fixtures must be reset using your existing light switch. Toggle the wall switch ON and OFF seven times (leave the switch in the ON position for five seconds before toggling to OFF).