

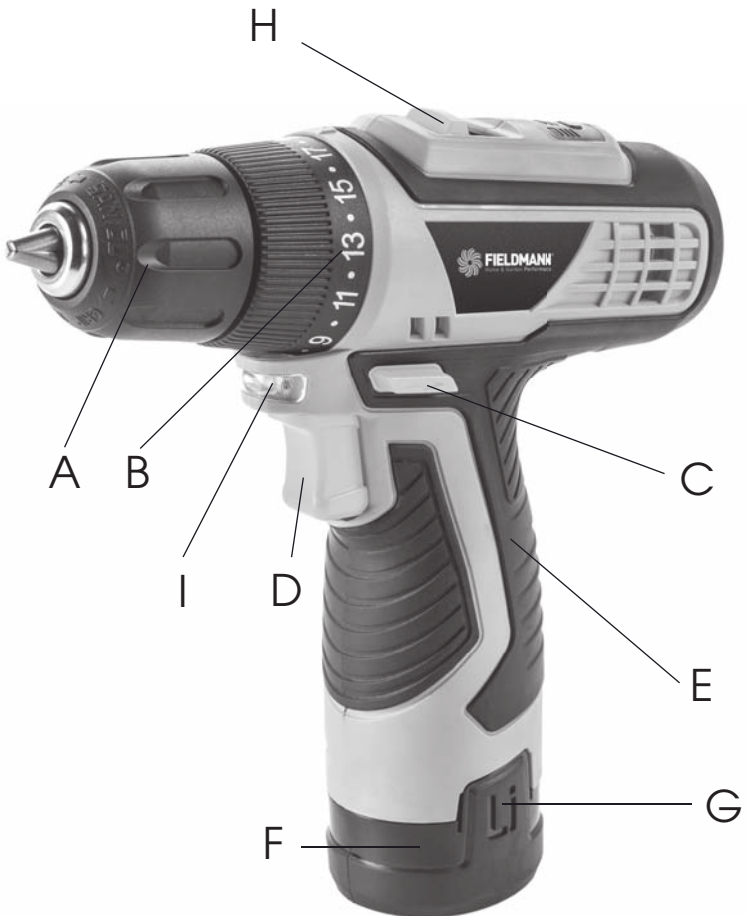

FDV 10250-A

English	5-24
Čeština.....	25-44
Slovenčina	45-64
Magyarul	65-84
Polski	85-106

1



2



3



4



5



6



7



Cordless Drill

USER'S MANUAL

Thank you for purchasing this cordless drill. Before you start using it, please, carefully read this user's manual and save it for possible future use.

CONTENTS

1. GENERAL SAFETY REGULATIONS	6
2. SYMBOLS.....	11
3. MACHINE DESCRIPTION AND INCLUDED CONTENTS.....	12
4. PUTTING INTO OPERATION.....	12
5. INSTRUCTIONS FOR PROPER USE.....	14
6. OPERATING INSTRUCTIONS	15
7. MAINTENANCE AND STORAGE	19
8. TECHNICAL SPECIFICATIONS.....	21
9. DISPOSAL.....	23

1. GENERAL SAFETY INSTRUCTIONS

⚠ WARNING! Carefully read the instruction manual before use.

Important safety warnings

- ✿ Unpack the product carefully and be sure not to throw away any part of the package before having found all components of the product.
- ✿ Keep the product in a dry place out of reach of children.
- ✿ Read all cautions and instructions. The failure to adhere to warning cautions and instructions may result in an accident, fire and/or a serious injury.

Packaging

The product is placed in a package preventing damage during transport. This package is a raw material therefore it can be handed-over for recycling.

Instructions for use

Before beginning to work with the machine, read the following safety rules and instructions for use. Familiarize with operating elements and the proper use of the device. Keep the manual in a safe place for future reference. We recommend keeping the original package including the inner packaging materials, cash voucher and guarantee card for a period of warranty at minimum. For a case of transportation, pack the machine into the original box from the manufacturer, thus ensuring a maximum protection of the product during a possible transport (e.g. moving or sending into a service station).

 **Note:** If you hand the machine over to next persons, hand it over together with the manual. Adherence to the attached instructions for use is a precondition for the proper use of the machine. The operation manual includes also instructions for operation, maintenance and repairs.

The manufacturer does not take any responsibility for accidents or damages resulting from the failure to adhere to this manual.

GENERAL SAFETY INSTRUCTIONS

Carefully read, remember and keep these safety instructions

⚠ WARNING! In the use of electric machines and power tools, it is necessary to respect and follow the following safety instructions for the reasons of protection against electric shock, personal injury and danger of fire. The term “power tool” in the instructions below refers both to mains-operated (corded) power tool or battery-operated (cordless) power tool. Save all warnings and instructions for future reference.

Workplace

- ✿ Keep the work area clean and well lit. Cluttered or dark areas in the workplace invite accidents. Store power tools that you don't currently use.
- ✿ Do not operate power tools in environments with danger of occurrence of a fire or explosion, such as in the presence of flammable liquids, gases, or dust. Power tools create sparks which may ignite the dust or fumes.
- ✿ Keep unauthorised persons, especially children, away from the work area while operating a power tool! Distractions can cause you to lose control over the performed activity. In no event leave your power tool unattended. Keep the equipment away from animals.

Electrical Safety

- ✿ Power tool plugs must match the mains socket outlet. Never modify the plug in any way. Do not use any adapter plugs with earthed (grounded) power tools. Undamaged plugs and matching outlets will reduce risk of electric shock. Damaged or fouled supply cables increase the risk of electric shock. If the power cord is damaged, it must be replaced by a new power cord which is available at the authorised service centre or the importer.
- ✿ Avoid body contact with earthed or grounded surfaces such as pipes, radiators, cooking ranges and refrigerators. There is an increased risk of electric shock if your body is earthed or grounded.
- ✿ Do not expose power tools to rain or wet conditions. Never touch the power tool with wet hands. Never wash the power tool under running water or immerse it in water.
- ✿ Never use the supply cable for other than intended purposes. Never use the cord for carrying or pulling the power tool. Never unplug the plug from the outlet by pulling the cable. Keep electric cables away from sharp or hot objects to prevent mechanical damage.
- ✿ The power tool was designed to be powered solely by alternating electric current. Always check if the electric voltage matches the information specified in the type label of the power tool.
- ✿ Never use power tool with damaged electric cable or plug or which has been dropped or is in any way damaged.

- ✿ If an extension cord is used, always check whether its technical parameters match the information specified in the type label of the power tool. When operating a power tool outdoors, use an extension cord suitable for outdoor use. If extension drums are used, these must be rolled out to prevent overheating of the cord.
- ✿ If a power tool is operated in a damp location or outdoors, its operation is only permitted if connected to an electric circuit protected by a residual current device <30 mA. Use of residual current device (RCD) reduces the risk of electric shock.
- ✿ Hold the power tool by insulated gripping surfaces only as the cutting or drilling tool may contact hidden wiring or its own power cord during operation.

Personal Safety

- ✿ Be careful, stay alert and watch what you are doing when operating a power tool. Concentrate on your work. Do not use a power tool while you are tired or under the influence of drugs, alcohol or medication. A moment of inattention while operating power tools may result in serious personal injury. Do not eat, drink and smoke while operating a power tool.
- ✿ Use personal protective equipment. Always wear eye protection. Use protective equipment corresponding to the type of work you are doing. Protective equipment such as dust mask, non-skid safety shoes, hard hat, or hearing protection used in accordance with the working conditions will reduce the risk of personal injury.
- ✿ Prevent unintentional starting. Do not carry the power tool while it is energised or with your finger on the switch or trigger. Ensure the switch or trigger is in the "off" position before connecting to power source. Carrying power tools with your finger on the switch or energising power tools that have the switch on may result in serious injuries.
- ✿ Remove any adjusting key or wrench before turning the power tool on. An adjusting wrench or a key left attached to a rotating part of the power tool may result in personal injury.
- ✿ Keep proper footing and balance at all times. Do not overreach. Never overestimate your own capabilities. Never use power tools while you are tired.
- ✿ Dress properly. Wear work clothes. Do not wear loose clothing or jewellery. Keep your hair, clothing, gloves and other part of your body away from moving or hot parts of the power tool.
- ✿ Connect the equipment to dust exhaustion. If the tools are provided for the connection of dust collection or exhaustion devices, ensure these are properly connected and used. Use of such devices can reduce dust-related hazards.
- ✿ Fix the work-piece tightly. Use a cabinet clamp or a cramp to fix the work-piece you are about to machine.
- ✿ Never use power tools if you are under the influence of alcohol, drugs, medication or other narcotic or addictive substances.
- ✿ This equipment is not intended for use by persons (including children) with limited physical, sensual or mental capacities or lack of experience or knowledge unless they are supervised or instructed about the use of the equipment by a person responsible for their safety. Children must be supervised to make sure they are not playing with the equipment.

Power Tool Use and Maintenance

- ✿ Always disconnect the power tool from the mains in case of any problem during the work, before cleaning the power tool or its maintenance, during each transportation and after the completion of the work! Never operate a power tool if it is damaged in any way.
- ✿ Immediately stop working if the power tool generates abnormal noise or smell.
- ✿ Do not overload the power tool. The power tool will operate better and safer if it is used at the rate for which it was designed. Use correct power tool which is intended for the given activity. The correct power tool will do the job it was designed for better and safer.
- ✿ Do not use the power tool if it cannot be safely turned on and off using the control switch. Use of such power tool is dangerous. Defective switches must be repaired by a certified service provider.
- ✿ Disconnect the tool from the power source before making any adjustments, changing accessories or maintenance. Such preventive safety measure prevents the risk of starting the power tool accidentally.
- ✿ Store idle power tools out of the reach of children and unauthorised persons. Power tools can be dangerous in the hands of untrained users. Store the power tools in a dry and safe place.
- ✿ Keep the power tool in good condition. Check the adjustment of moving parts and their mobility. Check for any damage to the protective guards or other parts which could affect safe operation of the power tool. If damaged, have the power tool properly repaired before further use. Many accidents are caused by poorly maintained power tools.
- ✿ Keep cutting tools sharp and clean. Properly maintained cutting tools with sharp cutting edges facilitate work, reduce the risk of injury and are easier to control. Use of accessories other than those specified in the instructions for use could result in damage to the power tool and cause injuries.
- ✿ Use the power tool, accessories and tool bits etc. in accordance with these instructions and in the manner intended for the particular type of power tool taking into account the working conditions and the work to be performed. Use of the power tool for purposes other than those the power tool was intended for could result in hazardous situations.

Use of Cordless Power Tools

- ✿ Before inserting the battery, make sure the switch is in the "O-OFF" position. Inserting a battery into a switched-on power tool could result in hazardous situations.
- ✿ Charge batteries only using the chargers prescribed by the manufacturer. Using a charger intended for other battery type could result in its damage and occurrence of fire.
- ✿ Use only batteries intended for particular power tool. Use of different batteries could cause injury or occurrence of fire.
- ✿ If the battery is not used, keep it separately from metal objects such as clamps, keys, bolts and other small metal items which could cause connection of one battery contact with the other. Short-circuiting the battery could result in injury, burns or occurrence of fire.

- ✿ Handle the batteries with care. Rough handling could result in leak of chemical substance from the battery. Avoid contact with such substance and if, nonetheless, any contact occurs wash the affected area under running water. If eyes get into contact with the chemical substance seek immediately medical aid. Chemical substance from the battery can cause serious injuries.

Service

- ✿ Do not replace parts of the power tool, do not make any repairs or interfere in any way with the construction of the power tool. Have your power tool repaired by qualified repair persons.
- ✿ Any repair or modification of the product without our company's authorisation is impermissible (it could cause injury or damage to the user).
- ✿ Always have your power tool repaired in a certified service centre. Use only original or recommended replacement parts. This will ensure that your safety and the safety of your power tool is maintained.

2. SYMBOLS



The product complies with the applicable standards and regulations.



Read the Instruction Manual attentively prior to use.



Use eyes protective equipment



Use ears protective equipment



Only re-charge the battery pack indoors.



Do not dispose of a battery pack with the household waste!



Do not dispose of a battery pack in water!



Do not burn the battery pack!

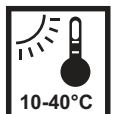

Do not expose the battery pack to sunlight or increased temperatures!

3. MACHINE DESCRIPTION AND INCLUDED CONTENTS

Machine description (see pic. 1)

- A) Keyless chuck
- B) Torque setting ring
- C) Rotation direction switch for movement forward/back and neutral position safety switch
- D) Trigger switch
- E) Handle
- F) Battery charge level LED display
- G) Battery
- H) 2 speed switch
- I) Lighting of the working area

Machine description (see pic. 2)

- 1) Battery adapter
- 2) Battery

Supplied contents

Carefully take the machine out of the packaging and check whether all the following parts are present:

- ✿ Cordless drill with 2x battery
- ✿ Battery charger station
- ✿ 13 pcs of accessories (6x bits, 6x drills + 1x magnetic holder)
- ✿ User's manual

If there are parts missing or they are damaged, please contact the vendor from whom you bought the machine.

4. PUTTING INTO OPERATION

Charging the machine

Proceed step by step according to the user's manual and use the pictures as a guide so that the assembly process is as easy as possible.

1. Take the battery out of the machine, press the release button and pull down to remove the battery.
2. Place the charger on a table near a power socket.
3. Properly insert the battery into the charger.

 **Note:** The battery may be inserted into the charger only in one way.

4. Connect the charger power cord to a power socket. At this time both the red and the green indicator light will be on.

5. As soon as the battery is fully charged, the green indicator light will stay on and the red indicator light will turn off.
6. After fully charging, disconnect the charger from the power socket. Before first use the battery must be fully charged.

For the first charge, it is recommended to charge the battery for 3-5 hours.

Drill chuck (see pic. 3)

If you wish to open up the drill chuck, hold the rear part of the chuck and turn the front part of the chuck anticlockwise. Insert the desired tool into the chuck. When tightening turn the front part of the chuck (while holding the rear part) clockwise and ensure that the jaws of the chuck firmly and evenly clamp the working tool.

Torque control (see pic. 4)

1. Torque control is ideal for presetting screwing strength. There are 15 positions + 1 drilling position. These positions are selected by turning the setting ring. Low values are intended for small screws and soft materials. High values are intended for large screws and hard materials.
2. If the torque control is used the clutch will work in the preset setting. This is ideal for repeat screwing, when all screws need to be screwed in at the same distance.
3. It is appropriate to start with the lowest setting and increase the amount of torque until the desired setting is achieved.

Turning on/off (see pic. 5)

⚠ ATTENTION: Start or release the start switch carefully according to the manufacturer's instructions.

Turn on the charged machine using the trigger switch (no. 1). Turn off the machine by releasing the switch, the chuck will stop turning.

1. Ensure that a battery is connected to the tool.
2. Start the tool by pressing the trigger switch.
3. The pressure applied to the power trigger switch determines the operating rotation speed of the chuck. The higher the pressure exerted on the trigger switch, the higher the rotation speed of the chuck.
4. If you want the chuck to rotate forwards, push the forward/back direction switch (no. 2) to the left. If you want the chuck to rotate backwards, push the forward/back direction switch to the right.
5. If the drill is not being used, set the forward/back direction switch (no. 2) to the neutral position (in the middle), to prevent accidentally starting the drill.

- ✿ Ensure that the bit or extension piece is correctly seated.
- ✿ The bit/extension piece must be placed directly on the workpiece before the drill is turned on. Otherwise the workpiece or the bit/extension piece will be damaged.
- ✿ Always check the rotation direction of the bit before using.
- ✿ The braking system is activated automatically after the trigger switch is released. The drill chuck will automatically stop rotating.

5. INSTRUCTIONS FOR PROPER USE

Fully charge the battery before first use. Ensure that the used drill bits and extension pieces are designed for the given task and that they are securely fastened. Check that the direction switch is set in the position for the desired rotation direction.

 **NOTE:** Always ensure that the battery is removed before changing working tools or before performing adjustments.

 **ATTENTION:** Dust created during grinding, cutting, drilling and other work tasks may in some cases contain chemical substances, which are known to cause health problems. Some examples of these chemical substances are:

- a) Lead from lead-containing paints.
- b) Cement and other construction products.
- c) Chemically treated wood.

Screwing

1. An appropriate opening should be drilled into the workpiece before screws are screwed into wood. This will prevent the movement of the screw and tool on the surface of the workpiece, which could damage it.
2. We recommend that for screwing you use slow rotation speeds.
3. Insert the screwing bit into the head of the screw and carefully screw it into the opening.
4. We recommend tightening using the lowest torque value and to gradually increase the torque value until the desired torque level is achieved.

Drilling

1. Do not use the torque control when drilling into wood. Select the standard drilling position.
2. When drilling into wood use wood drilling bits.
3. When drilling into metals or plastics use metal drilling bits.
4. When drilling into soft wood the drill should run at maximum speed.
5. When drilling into hard wood the drill should run at a lower speed.

LED Battery charge level indicator light (see pic. 6)

The LED indicator light is used to show the battery charge level. When the tool is turned on by the trigger switch the LED light (no. 1) comes on. If all the LED diodes are on, the battery is sufficiently charged. If only a single LED diode is on, the battery is virtually flat and must be charged immediately.

Lighting of the working area (see pic. 5)

The LED lighting (no. 3) is turned on when the trigger button is pressed and lights up the area that is being drilled or screwed. Turning off the trigger switch also turns off the LED lighting of the working area.

More advice about drilling

1. We recommend to secure the workpiece to the workbench so that you achieve the best results and safely operate the tool.
2. Use only sharpened drill bits. Blunt drill bits put an unnecessary load on the drill and may cause the motor to burn.
3. Always ensure that you are using the correct working tool for the task being performed.
4. When performing high precision drilling it is best to use a drill bit with a guiding rod. Non-ferrous materials like thin metal sheets are very difficult to drill. When performing high precision drilling place a piece of wood underneath the drilled material and then drill an opening through both pieces of material.

⚠ ATTENTION: When drilling it is not unusual for the drill bit to jam. In such a case there is a large momentum reaction. Always pay attention to what you are doing and hold the drill firmly to prevent possible damage or injury.

⚠ ATTENTION: Do not hold the trigger button down in the on position using adhesive tape or by other means. The electrical circuit in the tool would not work correctly, which could lead to overheating and subsequent damage to the tool.

Overload

If the tool becomes overloaded, the motor may be damaged. Increased pressure on the tool will not result in speeding up work. The effect of greater pressure on the tool will only lower effectiveness, which may cause the battery to go flat prematurely and may also destroy the motor. Non-standard types of work and the effect of excessive pressure will shorten the operating lifetime of the tool.

6. OPERATING INSTRUCTIONS

Operation

- ⚠ This product must not be used by children and persons with physical or mental impairments or by inexperienced persons, unless properly trained or schooled in the safe use of the product, or unless they have been properly supervised by a qualified person who will be responsible for their safety.
- ⚠ Use extra care if the product is used near children. Always keep the appliance out of reach of children. Children must be supervised to ensure that they do not play with the product.
- ⚠ Never allow children or persons who do not know the contents of this user's manual to work with the device. Local regulations may set the minimum age of the user. The user is responsible for damages caused to third parties in the machine's working area as a result of its use.
- ⚠ Do not use the machine if you are tired, under the influence of alcohol or narcotics.
- ⚠ If necessary, use personal protection aids (gloves, work footwear, eye protection, respirators, etc.). Personal protection aids reduce the risk of injury to persons.
- ⚠ Dress appropriately. Do not wear loose clothing or jewellery and make sure that your hair, clothing or gloves do not come dangerously close to moving parts. Loose clothing, jewellery or long hair may become caught in the moving parts.

- ☼ Pay constant attention, watch what you are doing and think when working with power tools. Do not use power tools if you are tired or under the influence of drugs, alcohol or medication. A moment of carelessness when working with power tools may lead to serious injury.
- ☼ Prevent the situation where the tool is turned on accidentally. Ensure the trigger switch is in the Off position before connecting the power cord to the power socket. Carrying power tools with the finger on the main trigger switch or connecting the power cord to the power socket when the main trigger switch is in the On position may cause injury.
- ☼ Do not get in your own way. When working, always maintain a firm posture and balance. This will make it possible to better control the power tool in unexpected situations.
- ☼ Use clamps or a vice to fasten the workpiece. It is safer than holding the workpiece in your hand and at the same time you have both hands free to operate the tool.
- ☼ Keep the working area tidy and well illuminated. A cluttered and badly lit work area may lead to injury.
- ☼ Do not work with the power tool in an explosive environment, such as for example areas where there are flammable liquid, gas or powder substances. Sparks are made inside the power tool, which may cause the ignition of flammable powder or vapour.
- ☼ Do not work with materials containing asbestos. Use a dust mask.
- ☼ When working with the tool ensure there is a safe distance from children and other persons. Distractions may lead to a loss of control over the tool.

Purpose of use

- ☼ This tool is not designed for professional use.
- ☼ Do not use the product for purposes other than those intended.
- ☼ For safety reasons the machine must not be used as a drive engine for any other work tools and tool sets, unless expressly permitted by the manufacturer.

Instructions for use

- ☼ Turn on and operate the machine as described in the user's manual, carefully follow all instructions.
- ☼ Before carrying out any kind of inspection, maintenance or repairs disconnect the charger power cable from the mains power supply.
- ☼ Use tools in good working condition for tasks for which they are designed.
- ☼ Work only during good visibility or ensure sufficient artificial lighting.
- ☼ Work in a clean and tidy working environment.
- ☼ Make sure that while working you maintain a firm and stable stance. Do not forget that falls represent one of the major causes of injuries during accidents.
- ☼ When drilling metal sheets use a vice and place a piece of wood underneath the sheet. A rotating metal sheet presents a serious risk.
- ☼ Make sure that the drill or screwdriver are not used for work on items under live current, to prevent injury by electrical shock. Before using this tool, check that you know the location of all electrical conductors or cables in the wall (use a metal detector for this purpose).
- ☼ Only store and use the product away from flammable or volatile materials and solutions.
- ☼ Keep the product away from extreme temperatures, direct sunlight and excessive humidity. Do not use in a dusty environment.

- ☼ Do not place the product near heaters, open fires or other appliances or equipment that are sources of heat.
- ☼ Do not spray the product with water or any other liquid. Do not pour water or any other liquids into the appliance. Do not submerge the appliance in water or any other liquid.
- ☼ Never leave the appliance switched on without supervision.
- ☼ Do not touch machine parts until they have come to a complete stop.
- ☼ Allow the motor to cool down before storing the machine in a closed room.
- ☼ Under no circumstances should you repair or alter the product yourself. Entrust all repairs and adjustments of this product to an authorised service centre or the vendor. Tampering with the appliance during the warranty period may void the warranty.
- ☼ The manufacturer is not responsible for damages caused by incorrect use of this product or its accessories. Such damages include food spoilage, injuries, burns, scalding, fire, etc.

Electrical safety

 **ATTENTION:** Read all the safety warnings and all instructions. If you fail to follow the provided warnings and instructions an injury caused by electrical shock could occur as well as fire or serious injuries.

 **NOTE:** Keep these warnings and instructions for future use. The term "electric power tool" in all warnings relates to your tool powered from the mains (it has a power cord installed) or cordless tools (without a power cord).

- ☼ The charger of the cordless device can be connected to any power plug, preventing discharge, that is installed according to norms in force.
- ☼ The plug must be powered at 230V ~50Hz.
- ☼ Disconnect the charger if you will not be using it for a long time, if you are changing the tool or performing maintenance on the tool.
- ☼ The power plug on the tool's charger cord must correspond to the power socket. Never modify the power plug in any way. Do not use any power plug adapters for tools protected by grounding. Unmodified power plugs and corresponding power sockets reduce the risk of injury by electrical shock.
- ☼ Do not touch grounded surfaces such as pipes, heaters, electrical stoves and refrigerators when working with the machine. When your body is grounded the risk of injury by electrical shock is increased.
- ☼ Do not expose the electrical tool to rain or a moist environment. The entry of water into the electrical tool increases the risk of injury by electrical shock.
- ☼ Handle the power cord with care. Never use the power cord to carry or move the tool and do not pull on it when you want to disconnect the tool from the power grid. Prevent the tool coming into contact with greasy, hot and sharp items or moving parts. A damaged or tangled up power cord increases the risk of injury by electrical shock.
- ☼ When working with electric power tools in a moist environment, the power circuit must have current protection installed (RSD - Residual Current Device). The use of a residual current device reduces the risk of injury by electrical shock.

Safety instructions for the battery and charger

- ✿ Use only the battery and charger supplied with this tool.
- ✿ Connect the charger only to a mains power socket with a voltage of 230V.
- ✿ Protect the battery and charger from moisture. Do not use the device in an outdoor environment.
- ✿ Disconnect the charger from the mains power socket when the charger is not being used, before cleaning the charger or before performing repairs on it.
- ✿ Take special care of the battery. Prevent the battery from falling on to a hard surface and do not expose the battery to the effects of pressure or other excessive mechanical stress. Keep the battery at a safe distance from excessive heat or cold.
- ✿ Do not attempt to repair or disassemble the battery or the charger. If any part is damaged, have it repaired by a qualified technician or send it for repair to an authorised service centre or the vendor.
- ✿ Charge the battery only when the ambient air temperature is between 10°C and 40°C. A charged battery may be used to power tools in operating conditions at a temperature between 0°C and 50°C. If the battery is not being used store it in a dry place at a temperature between 10°C and 30°C.

⚠ IMPORTANT! DANGER! Never short circuit the battery contacts and do not expose the battery to moisture. Do not store the battery together with metal items and parts, which could cause a short circuit of the battery contacts. The battery could overheat, catch on fire or explode.

- ✿ If any person comes into contact with the electrolyte or another liquid or substance found in the battery, they must immediately wash this substance away with large amounts of water. If these substances come into contact with eyes, flush the eyes out with large amounts of water and immediately seek medical treatment.
- ✿ Do not throw rechargeable batteries into a fire or into water. Otherwise an explosion could occur. A rechargeable battery should not be thrown out with ordinary household waste, regardless of the fact whether it has or has not been used. In accordance with valid regulations you should take the battery to a collection point or put it into the container labelled "Used Batteries" in our store.
- ✿ Only charge the battery in a charger designated by the manufacturer. A charger appropriate for one type of battery creates a fire hazard when used with another type of battery.
- ✿ Only use the electric power tool with a battery intended to be used in it. The use of different batteries may lead to a risk of injury or a fire hazard.
- ✿ If you are not using the battery, store it away from metal items, such as paper clips, coins, keys, nails, screws or other small items, which could lead to the short circuit of the battery contacts. Short circuiting the battery contacts may cause burns or a fire.

7. MAINTENANCE AND STORAGE

Maintenance

⚠ ATTENTION: Disconnect the charger if you will not be using it for a long time, if you are changing the tool or performing maintenance on the tool.

- ✿ This tool does not require any special maintenance. The same applies to the electrical parts of the tool.
- ✿ Check whether the device is showing signs of wear.
- ✿ If the charger is damaged (cover, conductors or connector), immediately arrange its replacement at the vendors service centre.
- ✿ Regular care for the machine will ensure not only a long lifetime and performance.
- ✿ Before use always visually check for worn or damaged parts.
- ✿ Replace damaged or worn parts. To ensure that the machine always remains balanced, always replace the entire set of the worn or damaged tools.
- ✿ Worn or damaged machine parts may only be replaced at an authorised service centre or the vendor.
- ✿ Before cleaning disconnect this product from the power source.
- ✿ To clean the plastic parts of the product, use a soft cloth dipped in lukewarm water. Do not use aggressive cleaning products and solvents as this could damage the surface of the appliance.
- ✿ Do not clean the machine under running water or submerge under water.
- ✿ After changing the working tool, check that the working tool is secured in its storage position.
- ✿ Do not use working tools that are not proportioned for placement into the tang in the magazine.
- ✿ Do not overload the electric power tool. Use the right type of electric power tool for your work. When the correct electric power tool is used, the work result will be performed better and more safety.
- ✿ If it is not possible to turn the main trigger switch on or off, do not work with the tool. All electric power tools with a trigger switch that do not work are dangerous and must be repaired.
- ✿ If you are not working with the tool, store it out of the reach of children and prevent persons not informed about the operation of the tool or this user's manual to work with the tool. An electric power tool in the hands of an unqualified person is dangerous.
- ✿ Perform maintenance on the tool. Check for deviation or blockage of the moving parts, damage of individual parts and other factors which could affect the operation of the tool. If the tool is damaged, have it repaired before using it. Many accidents are caused by neglected maintenance of a tool. Properly maintained cutting tools with sharp cutting edges are less prone to jamming in a workpiece and are easier to handle.
- ✿ Maintain cutting tools sharp and clean. Properly maintained cutting tools with sharp cutting edges are less prone to jamming in a workpiece and are easier to handle.
- ✿ Use electric power tools, accessories, working tools, etc. according to these instructions in a manner appropriate for the given type of electric power tool and take into consideration the work conditions and the type of work that you will be performing. Using electric power tools for purposes other than those for which they were designed may be dangerous.
- ✿ Damaged switches must be replaced at an authorised service centre or the vendor. Do not use electric power tools that cannot be turn on and off.
- ✿ Do not leave electric power tools turned on without supervision. Always turn the tool off and wait for it to come to a complete stop before putting it down.

- ✿ Use hearing protection. Excessive noise levels may cause hearing damage.
- ✿ When performing tasks, where the working tools may come into contact with hidden electrical conductors, hold the electric power tool by the insulated part that is intended to be held. A work tool that comes into contact with a "live" electrical conductor, will cause the uninsulated parts of the tool to become live and may subsequently cause injury by electrical shock to the operator.
- ✿ For repairs contact an authorised service centre or vendor who will use original spare parts. This will ensure the correct operation of the electric power tool.

⚠ ATTENTION: Using any accessories or tools not recommended in this user's manual may increase the risk of injury. Always use only original spare parts.

- ✿ Clean the tool after the completion of every work task.
- ✿ Do not use worn or damaged drill bits and drilling extension pieces. Such tools may overload the motor and lower effectiveness.
- ✿ Take proper care to prevent the motor from damage by oil or water.
- ✿ Regularly check that the tool has not been damaged during the course of standard operation. Make sure that all parts are correctly connected and do not use this product if any of its parts has been damaged or lost.
- ✿ When inserting the battery into the charger, ensure that the battery is inserted in the correct manner and that there are no materials between the battery contacts, e.g. soils.
- ✿ The battery and the charger should be protected from heat and the sun. Do not expose these products to extreme temperatures.
- ✿ Do not use the device in an outdoor environment.
- ✿ Use only the charger supplied with this tool.
- ✿ If the product is damaged or malfunctions, contact an authorised service centre or the vendor.

Storage

- ✿ Store the tool in a dry location at a sufficient distance from heat sources or dangerous vapours.
- ✿ Do not place any other items on the machine.

8. TECHNICAL SPECIFICATIONS

Cordless Drill:	
Nominal voltage	12V
Idling speed	0–350/0–1400 rpm
Battery	1,5 Ah, Li-ion
Torque	20 positions + 1 (drilling position)
Max. diameter	Ø10mm
Charger:	
Input voltage	230V
Frequency	50Hz
Charging time	3–4 hour

Instructions Manual - language version only.

Amendments to text and technical parameters are reserved.

Changes in the text, design and technical specifications may change without prior notice and we reserve the right to make these changes. keep it from turning as the drill bit rotates.

Troubleshooting

Suspected malfunctions are often due to causes the user can fix themselves. Therefore check the product using this section. In most cases the problem can be solved quickly.

WARNING!

Only perform the steps described within these instructions! All further inspection, maintenance and repair work must be performed by an authorized service centre or a similarly qualified specialist if you cannot solve the problem yourself!

Problem	Possible Cause	Solution
1.Product does not start	1.1 Not connected to power supply 1.2 Power cord or plug is defective 1.3 Other electrical defect to the product	1.1 Connect to power supply 1.2 Check by a specialist electrician 1.3 Check by a specialist electrician
2.Product does not reach full power	2.1 Extension cord is not suitable for operation with this product . 2.2 Power source (e.g. generator) has too low voltage 2.3 Air vents are blocked	2.1 Use a proper extension cord 2.2 Connect to another power source
3.Unsatisfactory result	3.1 Drill is dull/damaged 3.2 Drill bit is not suitable for work piece material	3.1 Replace with new one 3.2 Use proper Drill
4.Excessive vibration or noise	4.1 Drill bit is dull/damaged	4.1 Replace with a new one

9. DISPOSAL



The machine, rechargeable batteries, accessories and packaging should be sorted for environmental friendly recycling.

Do not dispose of power tools and batteries/rechargeable batteries into household waste!

Only for EC countries:



According to the European Guideline 2012/19/EU, power tools that are no longer usable, and according to the European Guideline 2006/66/EC, defective or used battery packs/batteries, must be collected separately and disposed of in an environmentally correct manner.

INSTRUCTIONS AND INFORMATION ON DISPOSING OF USED PACKAGING MATERIALS

Put any used package material to the place determined by the municipality for waste disposal.

DISPOSAL OF USED ELECTRIC AND ELECTRONIC EQUIPMENT



This symbol on products or accompanying documents means that used electric or electronic products must not be put to ordinary municipal waste. Hand over such products to determined collection points for proper disposal, restoration and recycling. Alternatively, in some countries of the European Union or other European countries you can return your products to your local dealer when you buy an equivalent new product. By dutiful disposal of this product you can preserve precious natural resources and you help prevent any potential adverse effects on the environment and human health which could be the results of wrong waste disposal. Ask your local authority or the nearest collection point for additional details. In case of improper disposal of this waste kind penalties can be imposed in accordance with national regulations.

For companies in the European Union countries

Should you want to dispose of electric and electronic devices, ask your dealer or vendor for necessary information. Disposal in other countries outside the European Union. Should you want to dispose of this product, ask your local authorities or your dealer for necessary information about disposal method.



This product fulfils all basic requirements of the EU directives that apply to it.

Text, design and technical specifications can change without prior notice and we reserve the right for their change.

User manual in the original language.

EU DECLARATION OF CONFORMITY

Product / brand: Cordless Drill / FIELDMANN

Type / model: FDV 10250-A as factory model D023

DC 10,8V (battery powered), speed 0-350/0-1400 rpm, diameter 10 mm

$L_{PA} = 76 \text{ dB(A)}$, $L_{WA} = 87 \text{ dB(A)}$

Manufacturer: FAST ČR, a.s.

U Sanitasu 1621, 251 01 Říčany, Czech Republic

VAT no: CZ24777749

This declaration of conformity is issued under the sole responsibility of the manufacturer.

The object of the declaration described above is in conformity with the relevant Union harmonization legislation:

Directive MD 2006/42/EC

Directive EMC 2014/30/EU

Directive NEOE 2000/14/EC

Directive RoHS 2011/65/EU+(EU)2015/863

The relevant harmonized standards and the other technical specifications:

EN 62841-1:2015+A11

EN 62841-2-1:2018+A11

EN IEC 55014-1:2021

EN IEC 55014-2:2021



Place of issuance: Prague

Date of issuance: 06. 09. 2023

Name: Petr Uher - Responsible Person

Signature:



FAST FAST ČR, a.s.⁻⁸⁷⁻
U Sanitasu 1621, 251 01 Říčany
tel.: +420 323 204 111
IČO: 247 77 749, DIČ: CZ 247 77 749

