

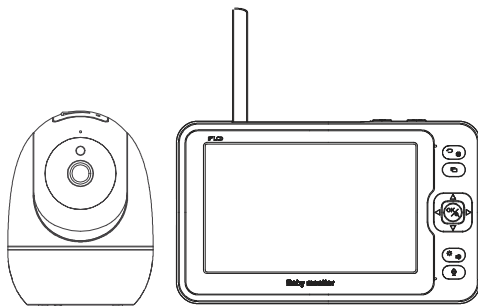

5 INCH 1080P FULL HD Baby Monitor



User Manual

Please read this manual thoroughly before use and keep it well for future reference.

SAFETY CAUTIONS

Incorrect operation of the product may lead to safety risks. Therefore, we **STRONGLY** recommend you read the instructions carefully before the first use.

- Please ensure that the proper power supply is used before using the camera.
- Please install the camera and bracket securely using the screws provided.
- Please use this product within the temperature range. When the ambient temperature is too high or too low, it may cause product failure.
- To avoid the risk of fire or electric shock, please keep your camera in a cool, dry place.
- Please keep the camera out of reach of small children.
- This product is not a toy; children should use the product under adult supervision.

PACKING LIST



Monitor x1

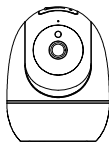

Camera x1



Mounting Bracket x1

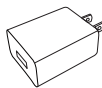

Power Adapter x2

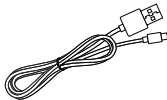

Type-C Cable x1
(For monitor)

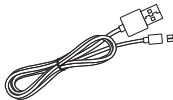

Micro USB Cable x1
(For camera)



Screws x1



User Manual x1

PRODUCT OVERVIEW

Camera

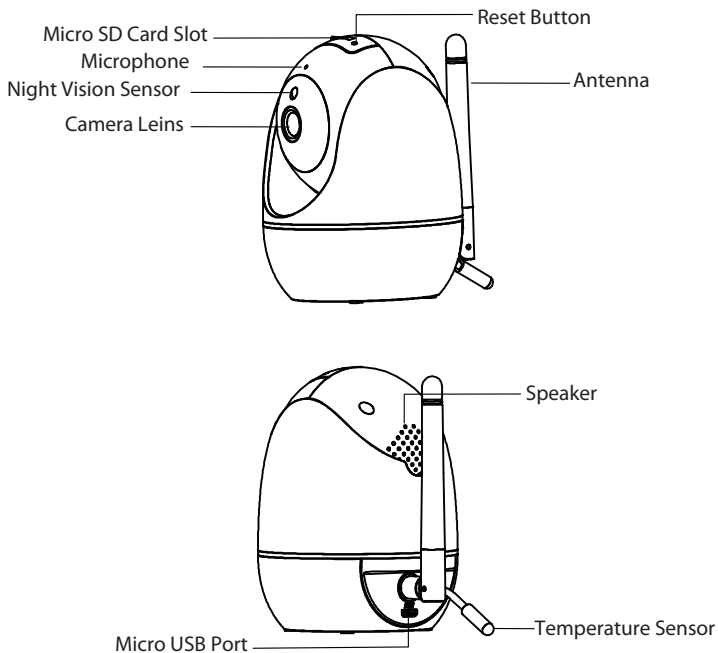

Monitor

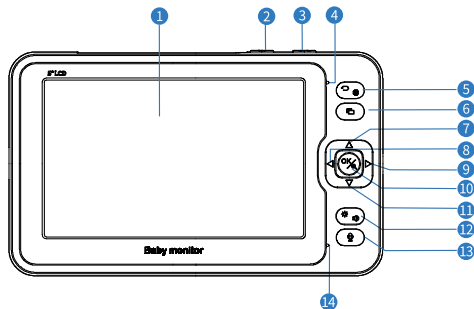

- 1 Screen:** Before the first use, please remove the protective film on the screen.
- 2 Power/Sleep Button:** Long press to power on/off the monitor; short press to turn on/off the screen.
- 3 VOX:** When you watch the live video, press it to turn on/off the sound detection.
- 4 Power Indicator:** It is green when the battery is fully charged, and will turn red when the battery is low.
- 5 Back/Menu:** Press it to enter menu page or as a back button.
- 6 Camera Switch:** To switch among cameras or loop the live video if 2 or more cameras are connected with the monitor.
- 7 Up:** Press it to tilt the camera upward or to change your selection upward.
- 8 Left:** Press it to pan the camera leftward or to change your selection leftward.
- 9 Right:** Press it to pan the camera rightward or to change your selection rightward.
- 10 OK:** Press it to zoom in/out or to confirm your selection.
- 11 Down:** Press it to tilt the camera downward or to change your selection downward.
- 12 Volume/Brightness:** Press it to bring up the Volume/Brightness menu, then press Left/Right/Up/Down to adjust the monitor's volume or brightness.
- 13 Talk:** Press and hold it to talk with your baby near the camera.
- 14 Microphone**

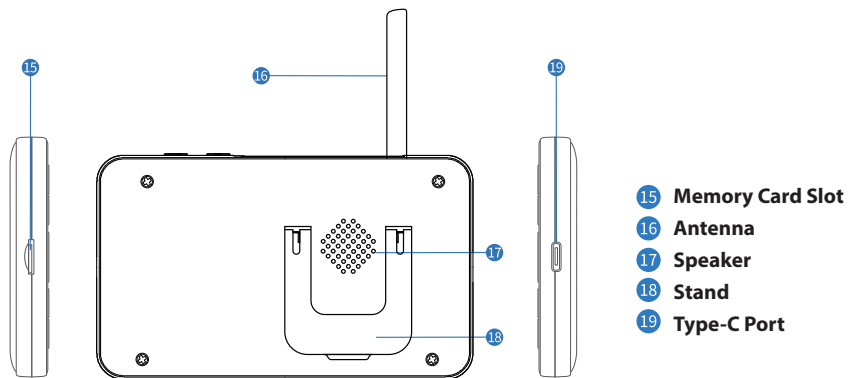

GETTING STARTED

Step 1:

Charge the monitor by connecting the **Power Adapter** to the monitor and a socket. It takes about 4 hours for the monitor to be fully charged, and the battery lasts about 8 hours.

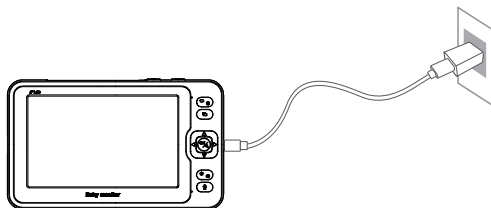

Step 2:

Connect the **Power Adapter** to the camera and a socket to power on the camera. There will be a beep from the camera after it is powered on.

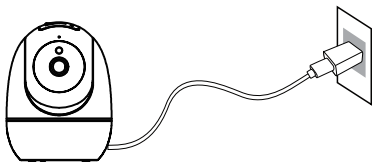
**Step 3:**

Place the camera at least 3ft/1m away from your baby.

Step 4:

Gently press and hold the **Power Button** for 3s to turn on the monitor, then you can see the live view.

Notes:

- 1 Generally, the camera has been paired with the monitor already. If it is not paired, please refer to the next section to pair it manually.
- 2 Install a memory card to the monitor or camera before you power on it if you would like to record videos.
- 3 After powering on your monitor, please set time & date firstly.
- 4 The monitor will not power on or will display abnormalities if its power is too low. Please try again after 10 minutes of charging.

FUNCTION OVERVIEW

Monitoring Interface



- 1 **Signal**
- 2 **Battery Power Status**
- 3 **Sound**
- 4 **Temperature**
- 5 **Feeding Reminder Enabled**
- 6 **Music Enabled**
- 7 **Sound Detection:** it will turn up if you enable VOX function.
- 8 **Live Video Loop Enabled**
- 9 **Camera Channel**
- 10 **Date and Time**

Other icons will be displayed on the monitoring interface when an alarm or notification for abnormality is issued.

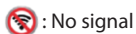

: No signal



: Temperature alarm



: Feeding reminder



: Low battery



: Sound alarm

Camera Setting

1. Pair a New Camera with the Monitor

Step 1:

Press  to enter the menu page and select Cameras.

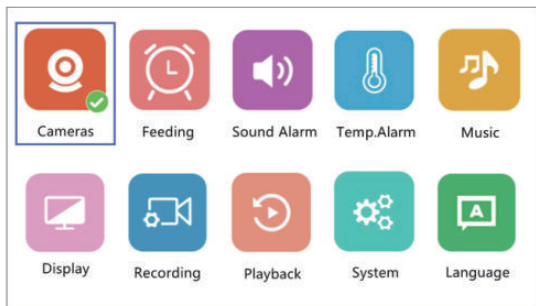

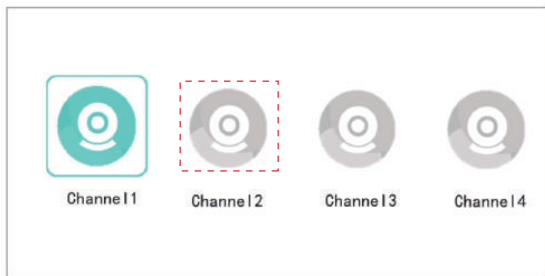

Step 2:

Select an unpaired channel (e.g. Channel 2) and press **OK**, the monitor will start searching for a camera.



Tip:

A grey icon  indicates that no camera is paired with this channel, while a green icon  indicates that a camera has been paired with this channel.

Step 3:

Keep the camera powered on and it will automatically pair with the monitor. You will see a prompt **Paired** after a success.

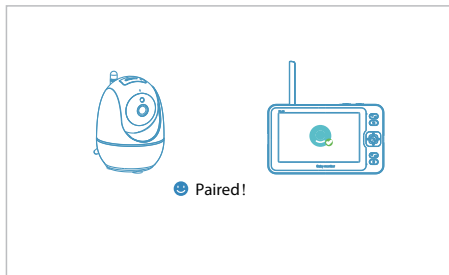
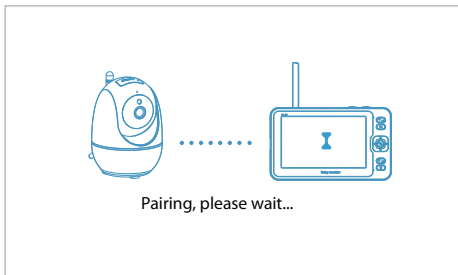

Notes:

- 1 If the pairing fails, you will see the prompt **Pairing failed** on the screen. Please repeat the steps above and try to pair again.
- 2 Four cameras at most can be paired with one monitor.
- 3 If you reset your camera, please don't pair it with a new channel but pair it with the original channel; otherwise, the pairing will fail.

2. Replace the Old Camera

If you would like to replace the old camera, just pair a new camera with the same channel which the old camera is previously paired with. The old camera will be deleted once the pairing is successful.

Feeding

This function aims to remind you of feeding your baby.

Step 1:

Select **Feeding** on the menu page.

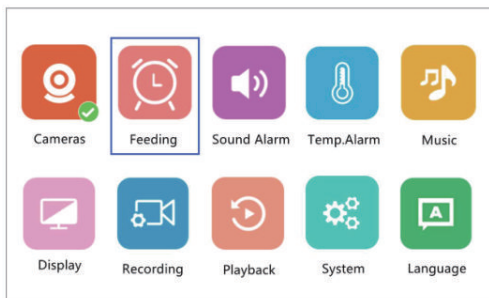

Step 2:

Set the Time Interval and **Repeat Mode**; press **OK** to confirm.

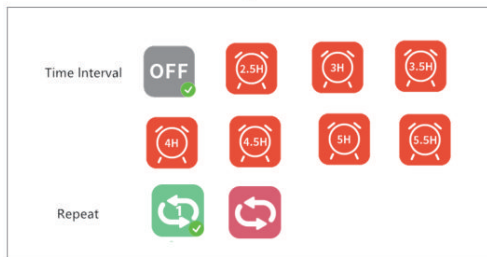

When you set the time interval as 2.5H, if you select , the alarm will be triggered only once in 2.5 hours; if select , the alarm will be triggered every 2.5 hours.

Tip:

The monitor will beep and display an icon  when it is the feeding time. Press any button to stop the alarm.

Sound Alarm

This monitor has a voice operated switch, also known as **VOX**. It will send alarms when the sound over a certain threshold is detected.

Step 1:

Select **Sound Alarm** on the menu page.

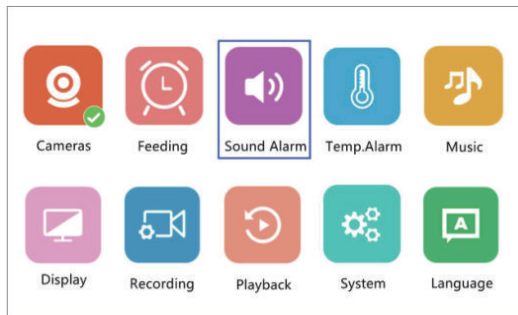

Step 2:

Select the sensitivity level and press **OK** to confirm.



- Tips:**
1. Set sensitivity for sound detection.
 2. **LOW:** the alarm threshold is a shouting cry.
 3. **MEDIUM:** the alarm threshold is a loud voice.
 4. **HIGH:** the alarm threshold is normal speech.

There are four options to adjust the sensitivity of sound detection: **OFF**, **LOW**, **MEDIUM** and **HIGH**. **OFF** means to disable sound detection. If you set the sensitivity to **LOW**, you will receive alarms only when your baby is crying loudly; if **MEDIUM**, you will receive alarms when your baby's voice is loud; if **High**, you will receive alarms just when your baby speaks normally.

Tip:

When the alarm is triggered, the monitor will screen on with an icon 📢 and make a sound alarm. Press any button to stop the sound alarm. Or you can press **VOX** button to turn off this function.

Temp. Alarm

The monitor will send alarms when the ambient temperature is too low (< 18°C/64°F) or too high (> 30°C/86°F).

Step 1:

Select **Temp. Alarm** on the menu page.

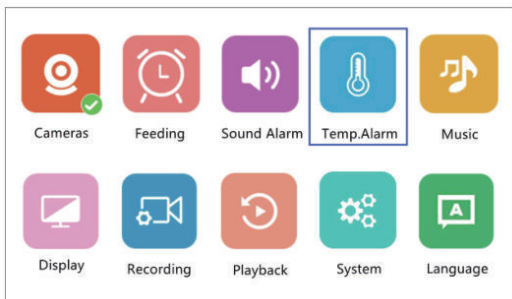

Step 2:

Enable the **Temp. Alarm** and select the **Temp. Unit**; press **OK** to confirm.

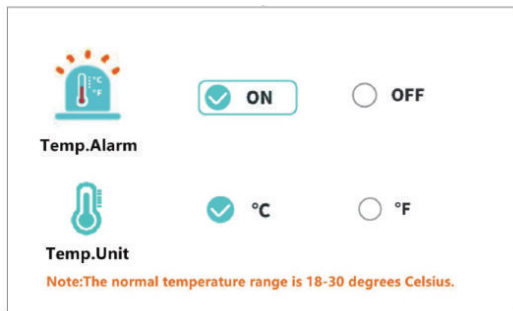

Tip:

When the alarm is triggered, the monitor will screen on with an icon  and make a sound alarm. Press any button to stop the sound alarm.

Music

This function is to comfort your baby when needed. The volume and type of each song are distinctive, please select the best one for your baby.

Step 1:

Select **Music** on the menu page.

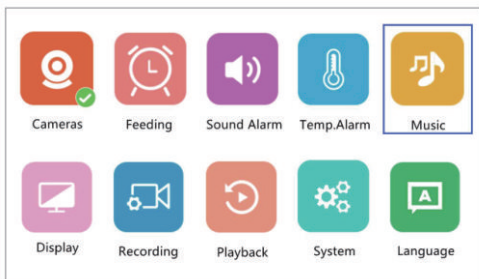

Step 2:

Select a song and set the playing mode; press **OK** to confirm.

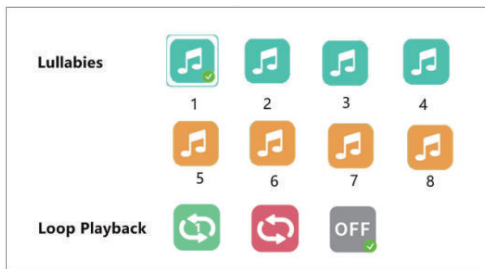

If you select one song, the song will be played repeatedly; if select **Loop Play**, four songs in the same category will be played in a loop.

Display

This function is to prolong your monitor's runtime by shutting down the screen.

Step 1:

Select **Display** on the menu page.

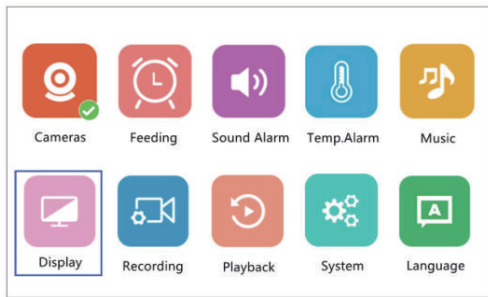

Step 2:

Set the time duration to enter sleep mode and press **OK** to confirm.

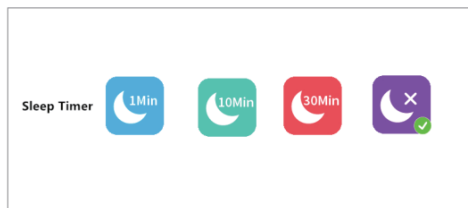

If you select **1 Min**, your monitor will enter sleep mode in 1 minute if there is no any operation; the same for **10 Min** and **30 Min**.

Recording

This function is to record videos for your baby. The maximum video length is 1 hour by default.

Step 1:

Select **Recording** on the menu page.

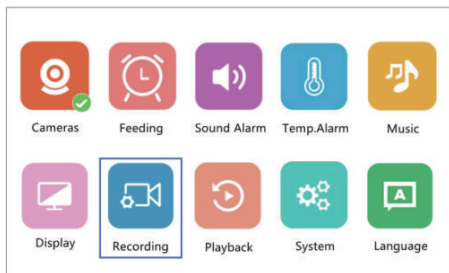

Step 2:

Enable it to record videos to the monitor or camera according to the memory card installation; press **OK** to confirm.

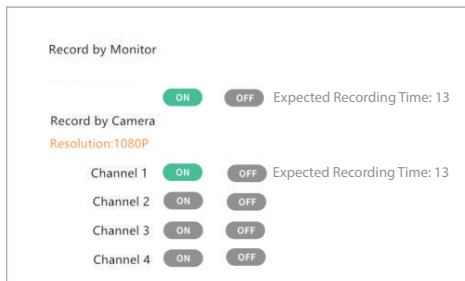

Tips:

- 1 After installed, your memory card will be formatted once you power on the monitor or camera.
- 2 Please set the date and time before you enable the function of recording videos so that you can search precisely for video playback.

Playback

Step 1:

Select **Playback** on the menu page, it will play the latest recorded videos on channel 1 by default. If there are no videos on channel 1, please select  to check more.

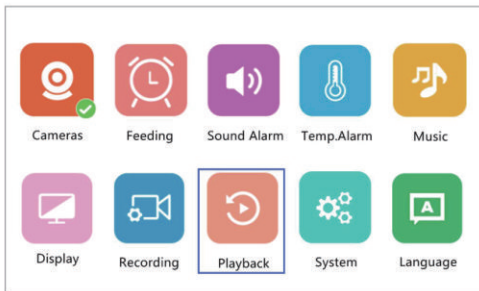

Step 2:

After you select  and press **OK**, it will pop up a search page. Set date, time and channel, then select **Search** and press **OK** to filter out your desired videos.

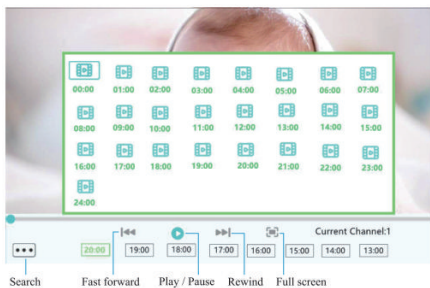
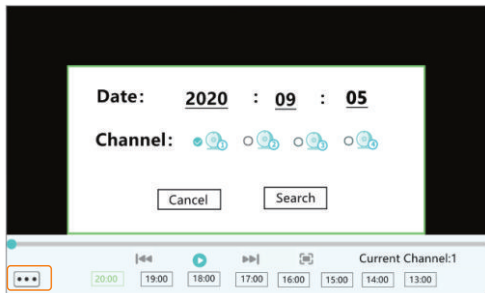

Tip:

Videos recorded in the monitor can only be watched through your monitor, and cannot be read via a computer. If you would like to watch videos recorded in the camera, please remove the card and watch videos on your computer via a card reader.

System

This function is to set Date&Time, change language, restore factory settings and check the software version.

Step 1:

Select **System** on the menu page.

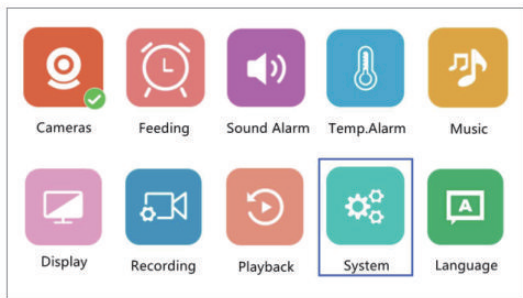

Step 2:

Set the date/time according to your local region, select your language, and check the remaining storage of the memory card. You can restore the monitor to factory settings as needed.

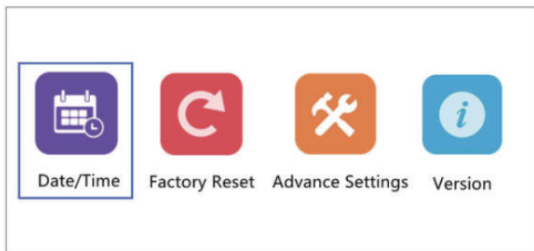

Language

Step 1:

Select **Language** on the menu page.

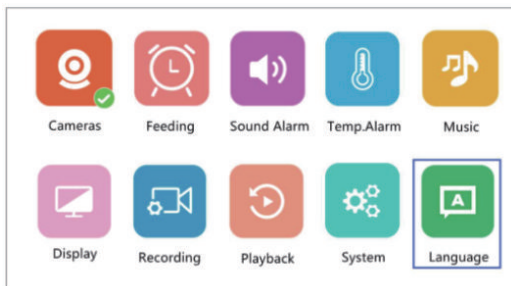

Step 2:

Select the language you need. After confirm the monitor will restart automatically.



Tip:

When change the language please make sure the monitor is with enough battery (The camera broadcast will sync to monitor language)

Installation Steps

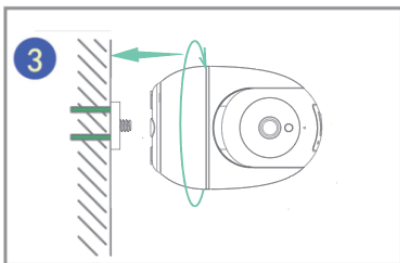
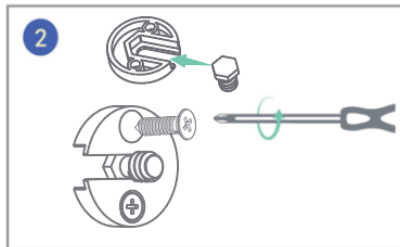
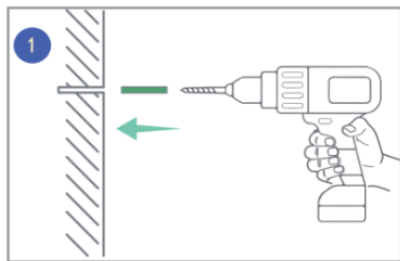

FAQ

Q: Why did I fail to connect the camera to the monitor?

A: Make sure to plug the power adapter into the camera and socket firmly.
Make sure the camera and the monitor are within the effective distance.

Q: Why is the live video so blurry?

A: Make sure there is no obstacle on the lens of the camera.

Q: Why did the monitor make noise?

A: The camera and monitor may be too close. Put them further apart.
Please adjust the angle of the antenna to minimize wireless interference.

Q: Can I hear my baby when I turn off the screen?

A: Yes. You should turn on **Sound Detection**, and it will wake up the screen and make a sound alarm if a loud sound is detected.

Q: Why is the picture black and white?

A: The **Night Vision Mode** will be activated if the camera worked in a dark environment (Brightness \leq 5 Lux).

Q: How long will the monitor stand by with screen on?

A: The monitor can last about 8 hours, and the time of endurance varies depending on the brightness.

SPECIFICATIONS

	Monitor	Camera
Frequency Range	2410.0~2469.5MHz	2410.0~2469.5MHz
Transmit Power(EIRP)	< 16dBm	< 17dBm

IMPORTANT

1. Power supply of 5V is recommended.
2. Do not over charge the battery.
3. Please use and store the product in dry place. Do not submerge it in water.
4. Do not put the battery into a fire, or heat the battery. Keep the battery away from fire. Do not store the battery in high temperature environment.
5. Keep the battery away from any sharp objects that could puncture into the battery to avoid risks of explosion and fire.
6. Don't use the battery if it emits an odor, deformation, leakage or any other abnormality.
7. If the battery leakage accidentally gets in your eyes, do not rub your eyes but immediately wash them with clean running water, and then seek medical assistance.
8. We recommend that the battery be charged and discharged once per 3 months at least if the battery is stored for long term.
9. Do not dispose of the battery as ordinary municipal waste. Please refer to local regulations on waste disposal of electronic products.



CE Certificate statement Website:

<https://www.foscam.com/company/ce-certificate.html>

Exporter and Importer Information Opened to Public:

<https://www.foscam.com/company/open-information.html>

Manufacturer: Shenzhen Foscam Intelligent Technology Co., Ltd
Addr: Room 901-902, Building 1B, Xingke 1st Street, Shenzhen International
Innovation Valley, Nanshan Dist., Shenzhen, 518055, China

www.foscam.com

Support email: support@foscam.com

Due to product upgrades and other reasons, this guide may be slow to update, resulting in slight inconsistencies with the official website information. Please take the official website (www.foscam.com) information as the current standard.