

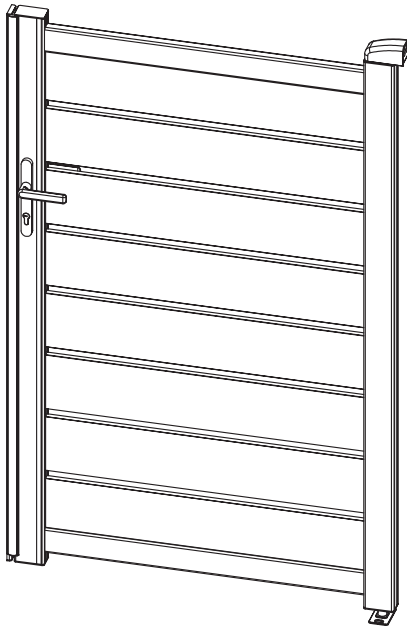

# Manual Gate G21 Reno 100x158 cm right



**EN DE CZ SK HU PL HR SLO**

۲۱



## **Thank you for purchasing our product.**

Before using this unit, please read this manual.

### **Assembly instructions:**

Prior to the assembly please read all instructions and information carefully. Check whether you have all parts which are necessary for the assembly.

### **Please mind your own safety.**

1. Use protective clothing and gloves as some parts might be sharp.
2. During the assembly no children or pets should be present in the working area.

### **Care and maintenance:**

Clean with a rag and water.

The English version of the manual is an exact translation of the original manufacturer's instructions. Images used in this manual are for illustrational purposes only and may differ from the actual product.



## **Vielen Dank für den Kauf unseres Produktes.**

Bevor Sie dieses Gerät verwenden, lesen Sie diese Anleitung.

### **Montageanleitung:**

Vor der Montage lesen Sie bitte alle Anweisungen und Angaben vorsichtig. Überprüfen Sie, ob alle Teile, die für die Montage notwendig sind, vorhanden sind.

### **Bitte beachten Sie zu Ihrer eigenen Sicherheit.**

1. Tragen Sie Schutzkleidung und Arbeitshandschuhe, da einige Teile scharfe Kanten haben können.
2. Während des Zusammenbaus sollten sich keine Kinder oder Tiere im Arbeitsbereich aufhalten.

### **Pflege und Wartung:**

Mit einem Lappen und Wasser reinigen.

Die deutsche Version der Anleitung ist eine genaue Übersetzung der Anleitung des Herstellers. Die in diesem Handbuch verwendeten Bilder dienen nur zur Illustration und können nicht genau das Produkt entsprechen.

**GZ**

## **Děkujeme za nákup našeho výrobku.**

Před použitím si prosím přečtete tento návod.

### **Montážní návod:**

Dříve, než začnete s montáží, pečlivě si prostudujte všechny pokyny a informace. Zkontrolujte, zda máte všechny potřebné díly pro stavbu.

### **Dbejte na svoji bezpečnost.**

1. Při montáži použijte ochranný oděv a rukavice, protože některé části mohou být ostré.
2. V době montáže by se po staveništi neměly pohybovat děti a domácí zvířata.

### **Péče a údržba:**

Čistěte za pomoci hadru a vody.

Česká verze návodu je přesným překladem originálního návodu výrobce.

Fotografie použité v manuálu jsou pouze ilustrační a nemusí se přesně shodovat s výrobkem.

**SK**

## **Ďakujeme za nákup nášho výrobku.**

Pred použitím si prosím prečítajte tento návod.

### **Montážny návod:**

Skôr, než začnete s montážou, pozorne si preštudujte všetky pokyny a informácie. Skontrolujte, či máte všetky potrebné diely na stavbu.

### **Dbajte na svoju bezpečnosť.**

1. Pri montáži používajte ochranný odev a rukavice, pretože niektoré časti môžu byť ostré.
2. V čase montáže by sa po stavenisku nemali pohybovať deti a domáce zvieratá.

### **Starostlivosť a údržba:**

Čistíte za pomocou handry a vody.

Slovenská verzia návodu je presným prekladom originálneho návodu výrobcu.

Fotografie použité v návode sú len ilustračné a nemusia sa presne zhodovať s výrobkom.



## **Köszönjük, hogy megvásárolta termékünket.**

Kérjük, használat előtt olvassa el ezt a kézikönyvet.

### **Telepítési útmutató:**

Kérjük, az összeszerelés megkezdése előtt figyelmesen olvassa el az összes utasítást és információt. Győződjön meg arról, hogy minden alkatrész megvan, amelyre szüksége van az építéshez.

### **Ügyeljen a biztonságára.**

1. Összeszereléskor viseljen védőruházatot és védőkesztyűt, mivel egyes részek élesek lehetnek.
2. Gyerekek és háziállatok nem tartózkodhatnak az építkezésen az összeszerelés során.

### **Ápolás és karbantartás:**

Tisztítsa meg ronggyal és vízzel.

A magyar használati utasítás a gyártótól kapott verzió pontos fordítása.

A kézikönyvben használt fényképek csak illusztrációk, nem egyeznek meg pontosan a termékkel.



## **Dziękujemy za zakup naszego produktu.**

Przed użyciem prosimy o zapoznanie się z niniejszą instrukcją.

### **Instrukcje Instalacji:**

Przed przystąpieniem do montażu prosimy o dokładne zapoznanie się ze wszystkimi instrukcjami i informacjami. Upewnij się, że masz wszystkie części potrzebne do zbudowania.

### **Zadbaj o swoje bezpieczeństwo.**

1. Podczas montażu należy nosić odzież ochronną i rękawice, ponieważ niektóre części mogą być ostre.
2. Podczas montażu nie wolno pozwalać dzieciom ani zwierzętom na poruszanie się po terenie budowy.

### **Opieka i utrzymanie:**

Czyścić szmatką i wodą.

Polska wersja językowa instrukcji jest dokładnym tłumaczeniem oryginalnej instrukcji producenta. Zdjęcia wykorzystane w tym podręczniku są jedynie ilustracją i nie może dokładnie dopasować produkt.

**HR**

## **Zahvaljujemo što ste kupili naš proizvod.**

Prije uporabe pročitajte ovaj priručnik.

### **Upute za instalaciju:**

Prije početka montaže pažljivo pročitajte sve upute i informacije. Provjerite imate li sve dijelove potrebne za izgradnju.

### **Vodite računa o svojoj sigurnosti.**

1. Nosite zaštitnu odjeću i rukavice prilikom sastavljanja jer neki dijelovi mogu biti oštri.
2. Djeci i kućnim ljubimcima ne smije se dopustiti da lutaju gradilištem tijekom montaže.

### **Njega i održavanje:**

Očistite krpom i vodom.

Hrvatska verzija priručnika točan je prijevod originalnih uputa proizvođača.

Slike korištene u ovom priručniku služe samo za ilustraciju i mogu se razlikovati od stvarnog proizvoda.

**SLO**

## **Zahvaljujemo se vam za nakup našega izdelka.**

Pred uporabo preberite ta priručnik.

### **Navodila za namestitev:**

Pred začetkom montaže natančno preberite vsa navodila in informacije. Prepričajte se, da imate vse dele, ki jih potrebujete za gradnjo.

### **Poskrbite za svojo varnost.**

1. Pri sestavljanju nosite zaščitno obleko in rokavice, saj so lahko nekateri deli ostri.
2. Otroci in hišni ljubljenci se med montažo ne smejo sprehajati po gradbišču.

### **Nega in vzdrževanje:**

Očistite s krpo in vodo.

Slovenska različica navodil za uporabo je natančen prevod originalnih proizvajalčevih navodil. Fotografije, uporabljene v navodilih, so samo ilustrativne in se morda ne ujemajo popolnoma z izdelkom.



**EN Installation**

**DE Montage**

**CZ Montáž**

**SK Montáž**

**HU Összeszerelés**

**PL Montaż**

**HR Sastavljanje**

**SLO Montáž**

**EN** Tools you will need

**DE** Werkzeuge, die Sie brauchen

**CZ** Nástroje, které budete potřebovat

**SK** Nástroje, ktoré budete potrebovať

**HU** Szükséges eszközök és szerszámok

**PL** Przyrządy i narzędzia, które będą potrzebne

**HR** Alati koji će vam trebati

**SLO** Orodja, ki jih boste potrebovali

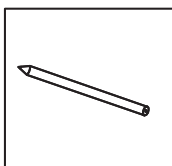
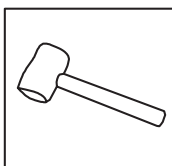
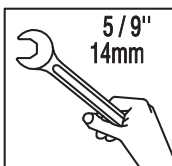
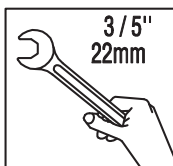
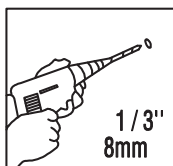
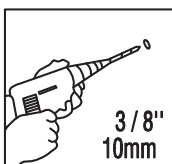
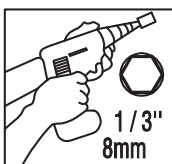
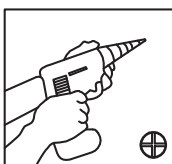
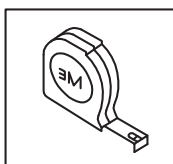
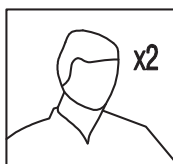

**EN** Dimensions

**DE** Abmessungen

**CZ** Rozměry

**SK** Rozmery

**HU** Méretek

**PL** Wymiary

**HR** Dimenzije

**SLO** Dimenzije

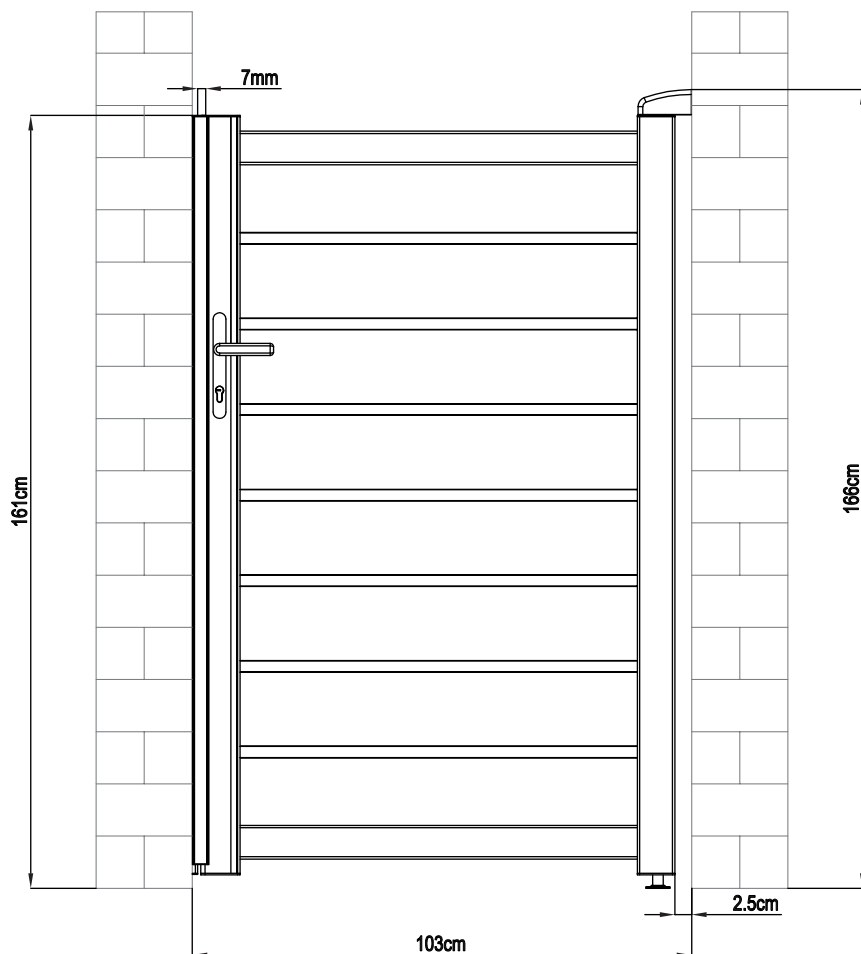

EN Parts list

DE Teileliste

CZ Seznam dílů





































SK Zoznam dielov

HU Alkatrész lista

PL Wykaz części

HR Popis dijelova

SLO Seznam delov

	#	mm	PCS		#	mm	PCS
	AT-A1	1573	1		Dr-15		1
	AT-A2x	1573	1			Dr-17	
	AT-A9	1573	1			Dr-30	
	SR-A3	959	2		Dr-31		2
	VT-A4	868	7		Dr-18a		1
	VT-A4a (+SR-A15)	868	1		Dr-19a		1
	AT-A5	1573	1		Dr-22		1
	AT-A5a	395.5	1		Dr-23		1
	Dr-A5b	937	1		Dr-24		4
	Dr-A5c	19.5	1		Dr-28		4
	AT-A11	1573	2		Dr-25a		2
	AT-A11	1573	2		Dr-26		3
	VT-A6	23	14		Dr-27		2
	AT-7	29.5	4		VT-B30	ST4x10	4
	AT-A7	1553	1		VT-B31	ST4.2x13	4
	AT-8		1		VT-B32	M8x60	6
	AT-9		1		VT-B33	ST5.5x38	8
	AT-10		2		VT-B34	M6x50	3
	Dr-11		1		VT-B35	ST4.8x38	32
	Dr-12		1				
	Dr-13		1				
	Dr-14		1				

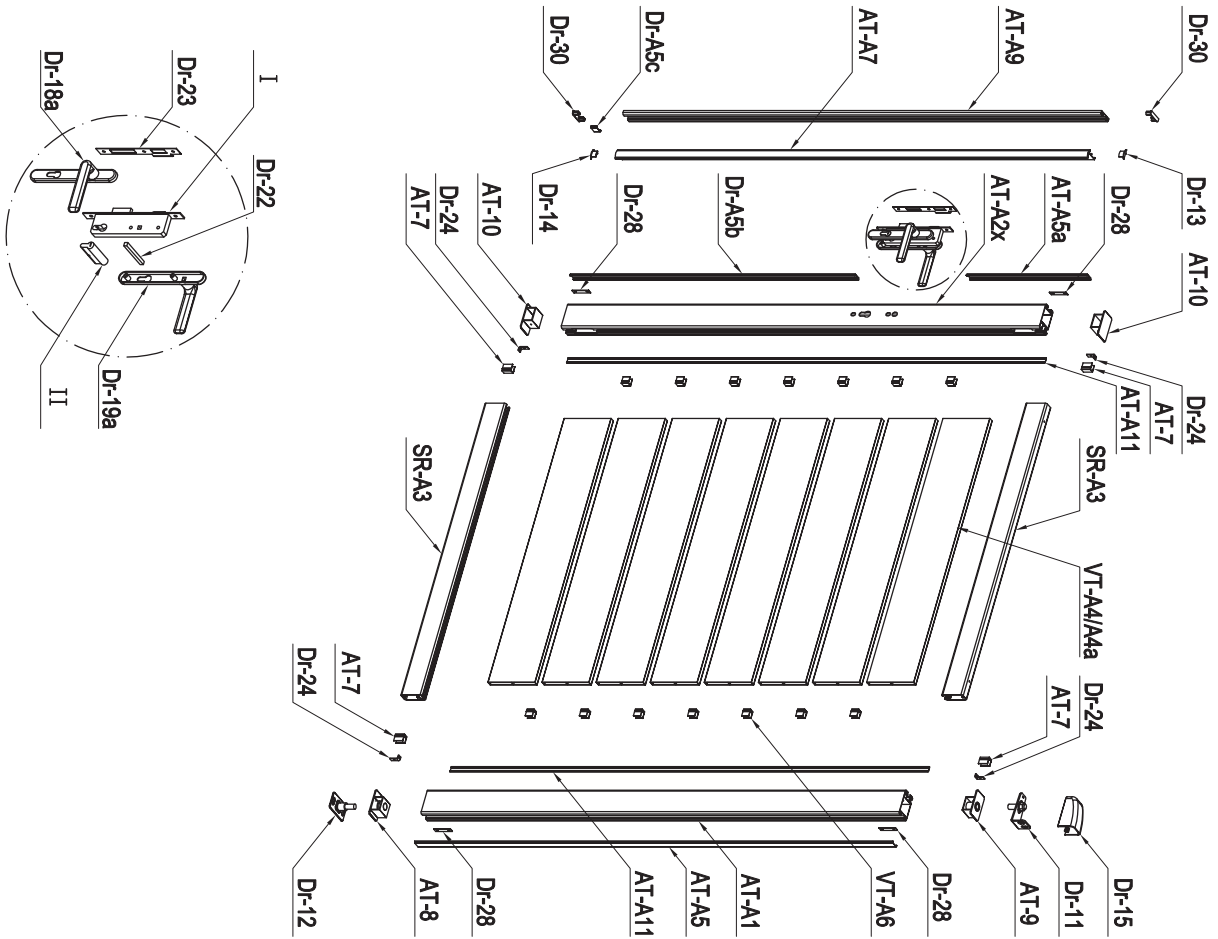

**EN** Assembly instructions

**CZ** Návod k montáži

**HU** Szerelési útmutató

**HR** Upute za montažu





**DE** Montageanleitung

**SK** Návod k montáži

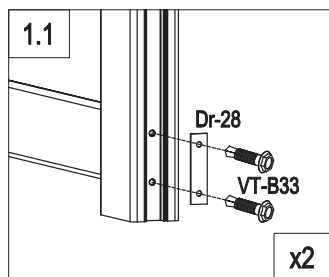
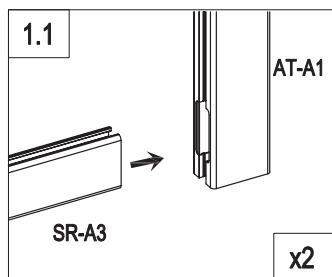
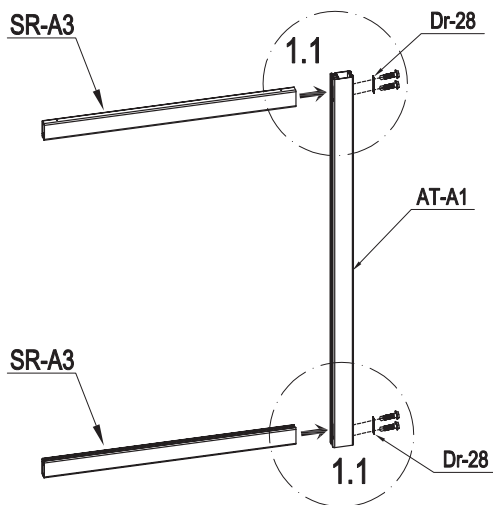
**PL** Instrukcja montażu

**SL** Navodila za namestitev



	AT-A1	1
	SR-A3	2
	Dr-28	2
	VT-B33	4

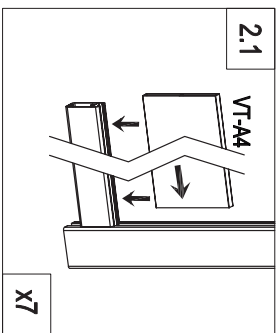
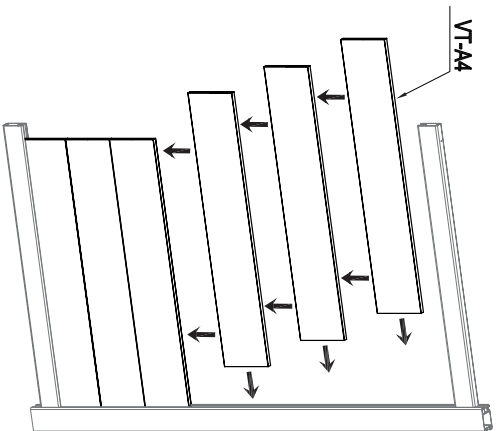



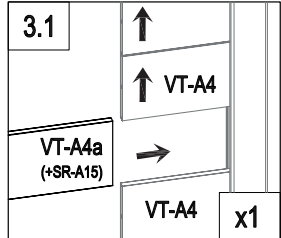
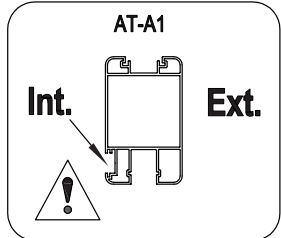
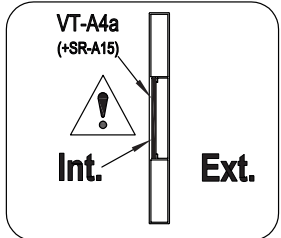
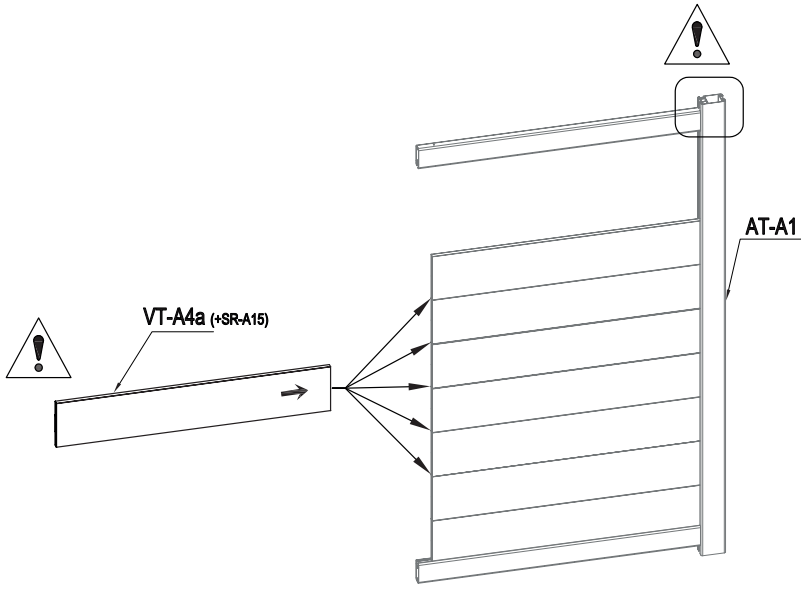

	VT-A4	7
---	-------	---

2

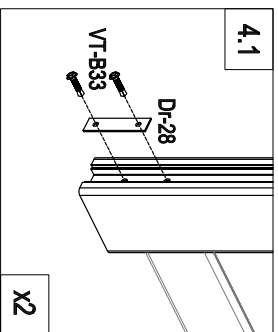
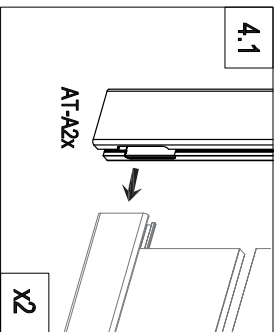
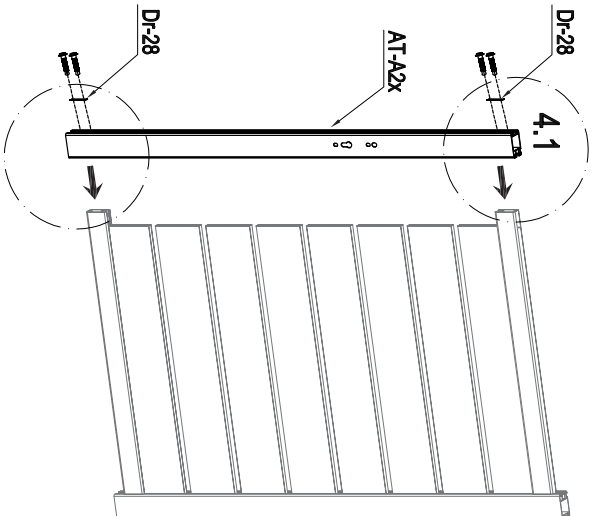

	VT-A4a (+SR-A15)	1
--	------------------	---



	AT-A2X	1
	Df-28	2
	VT-B33	4

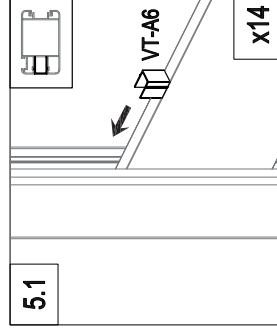
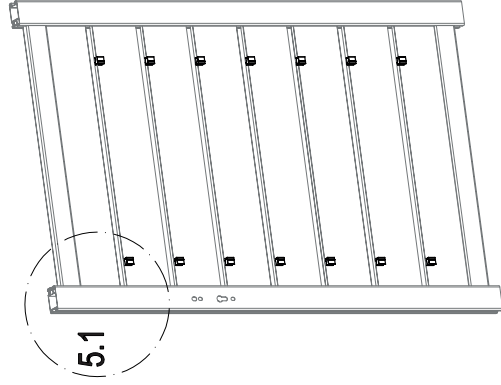



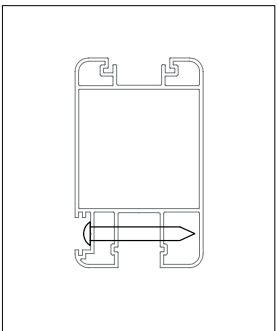
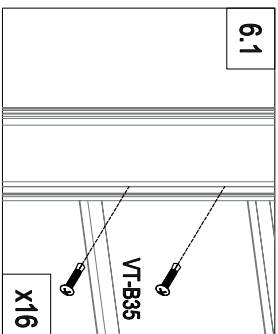
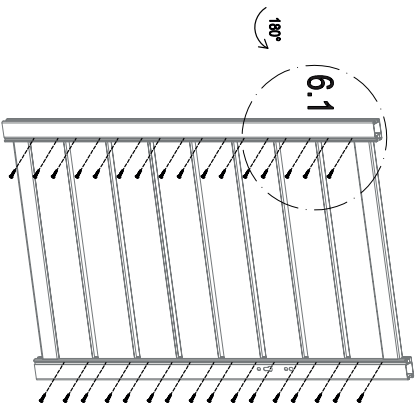
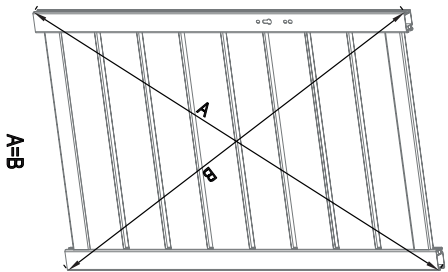

	VT-A6	14
--	-------	----

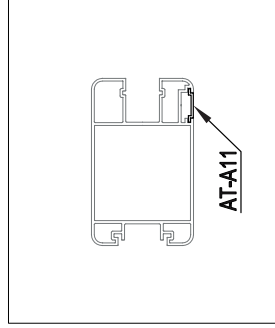
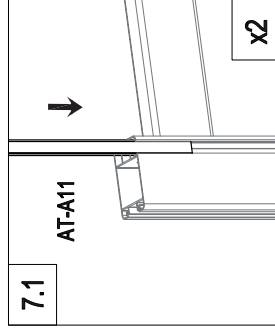
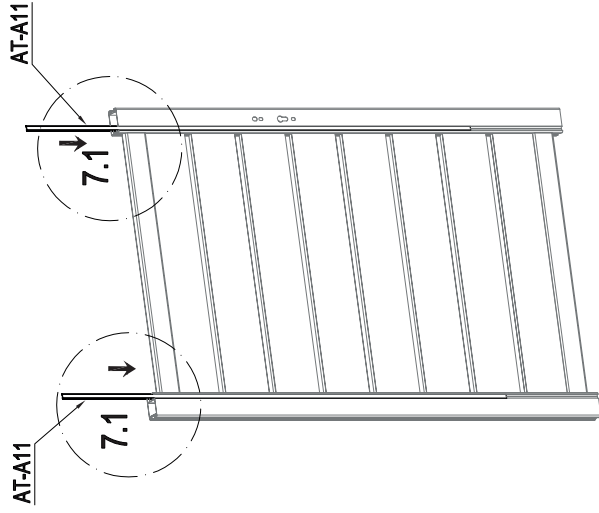

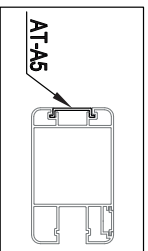
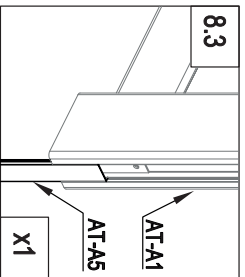
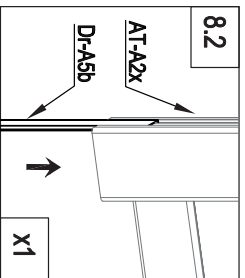
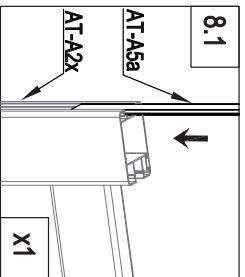
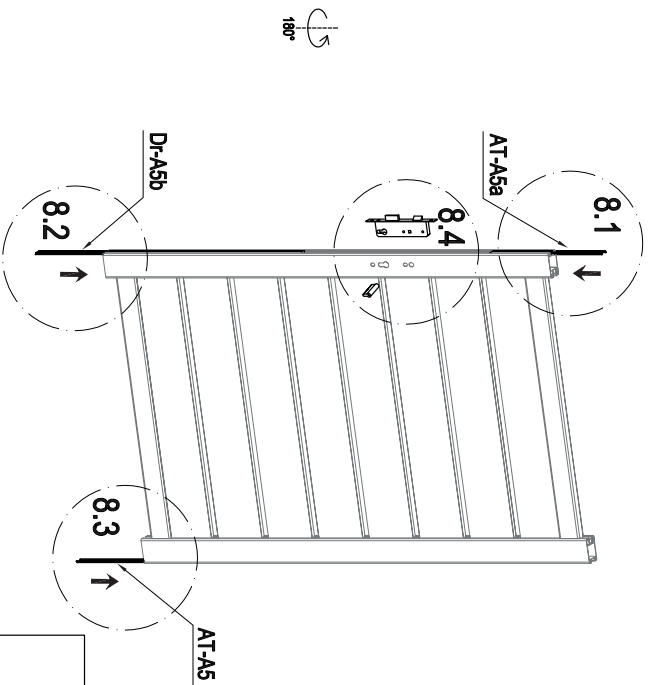
	VT-B35	32
---	--------	----





	AT-A5a	1		I	1
	Df-A5b	1		II	1
AT-A5	1		III	1	

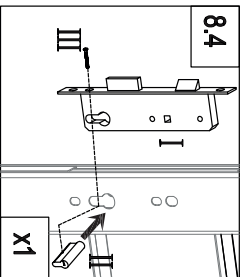

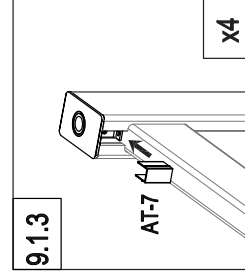
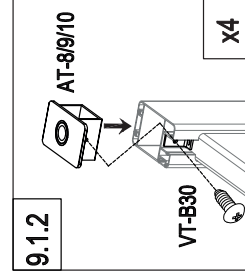
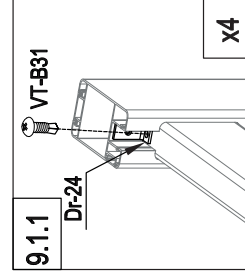
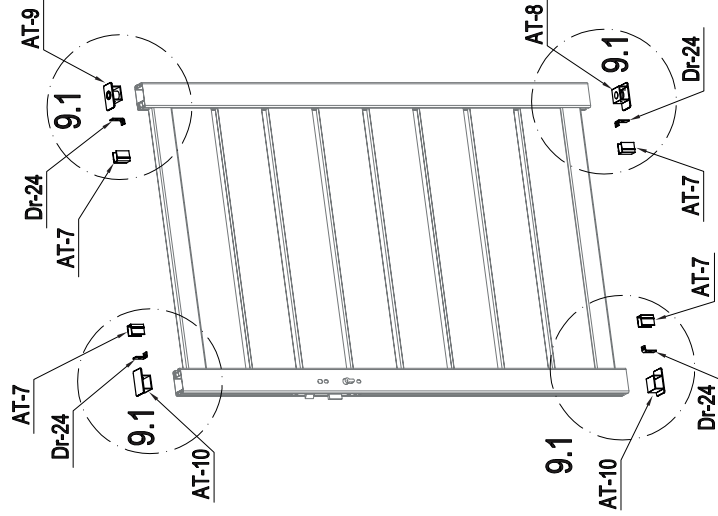

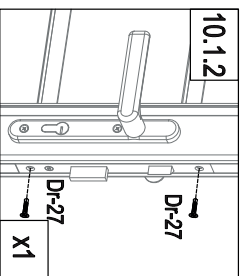
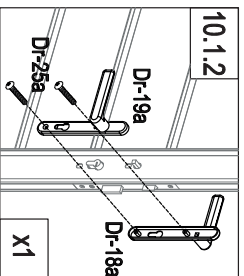
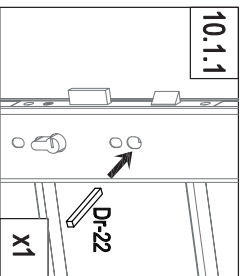
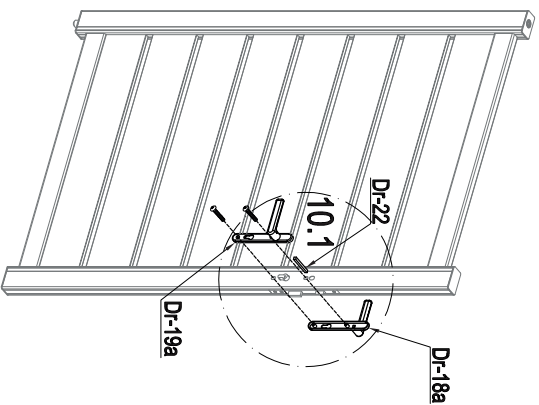

	AT-8	1
	AT-9	1
	AT-10	2
	AT-7	4

	Dr-24	4
	VT-B30	4
	VT-B31	4

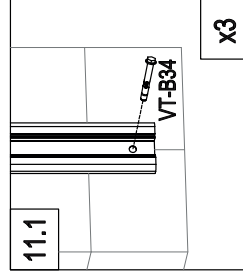
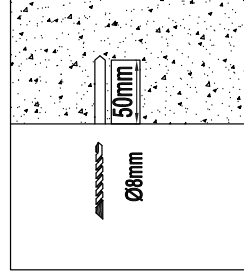
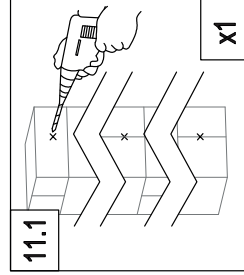
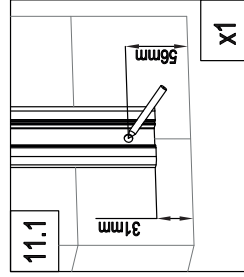
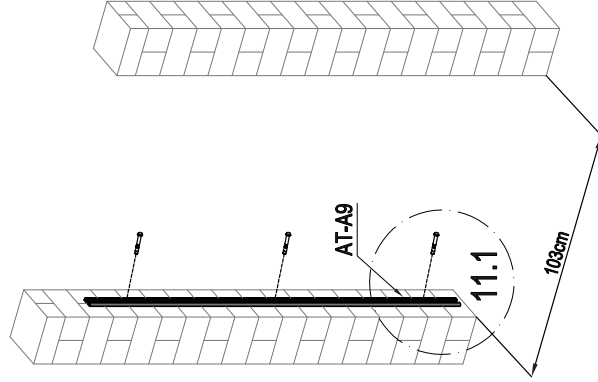

	D-18a	1
	D-19a	1
	D-22	1
	D-25a	2
	D-27	2



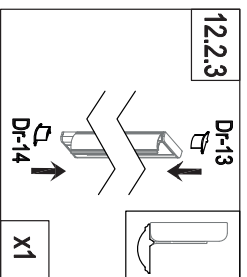
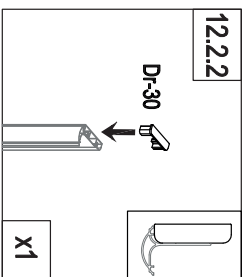
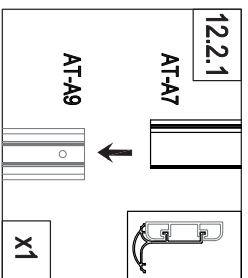
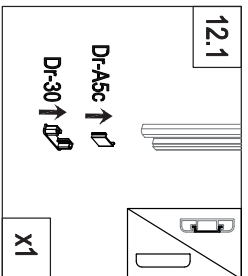
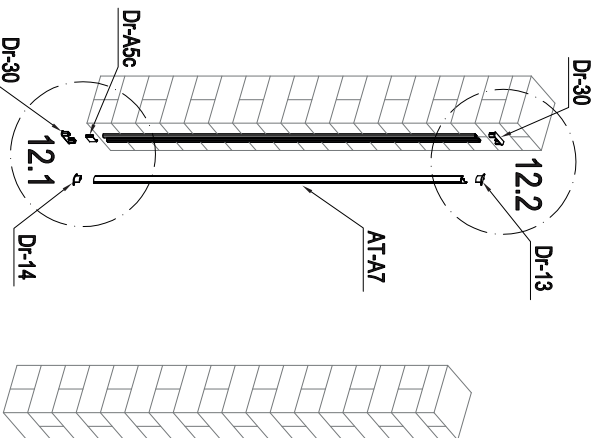

	AT-A9	1
	VT-B34	3

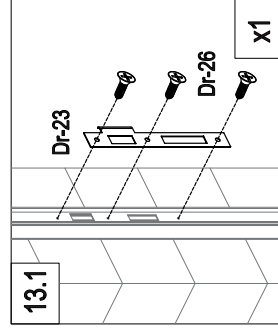
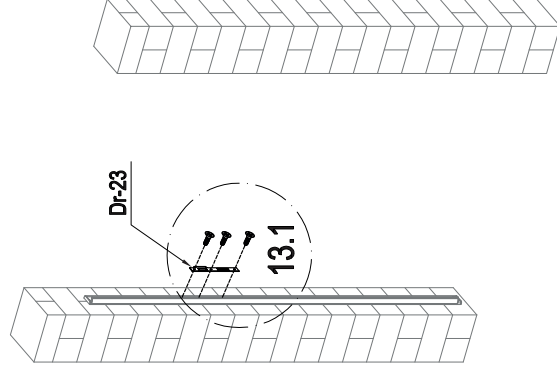

	AT-A7	1
	Dr-13	1
	Dr-14	1
	Dr-30	2
	Dr-A5c	1



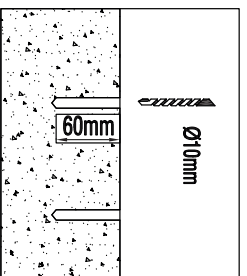
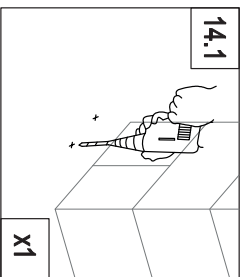
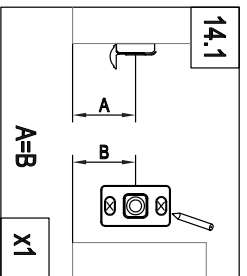
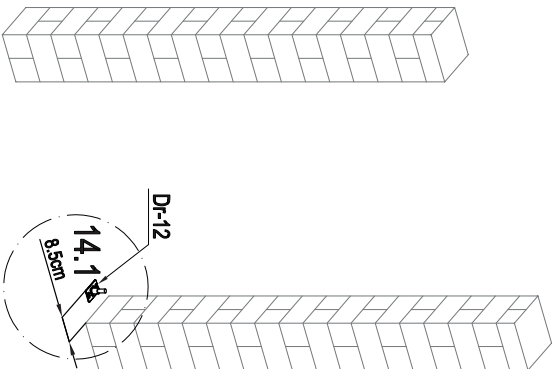

	Dr-23	1
	Dr-26	3

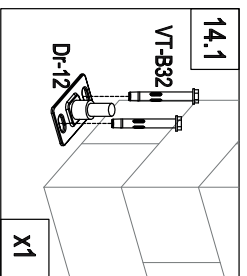

	D-12	1
	VT-B32	2

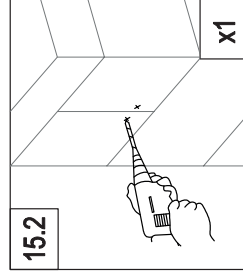
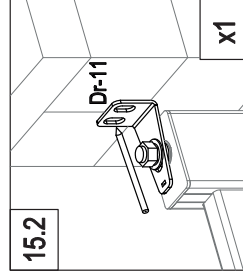
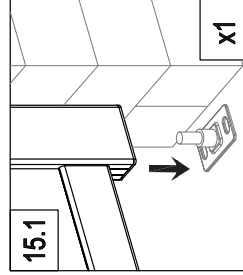
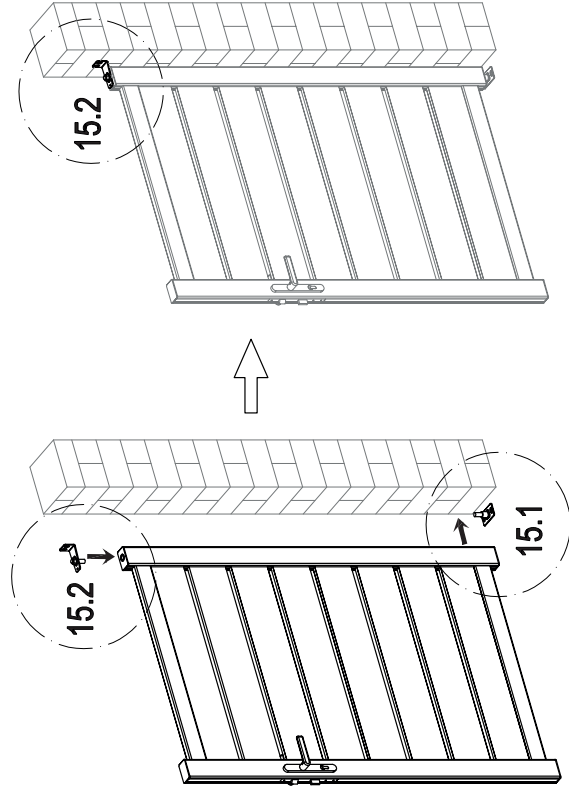



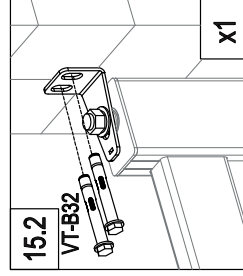
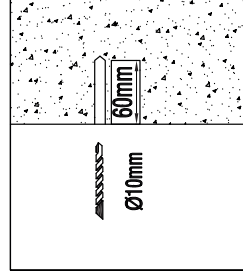

	1
	2

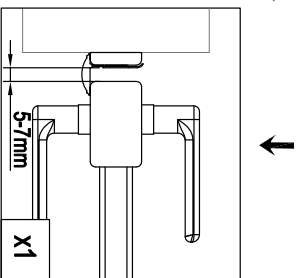
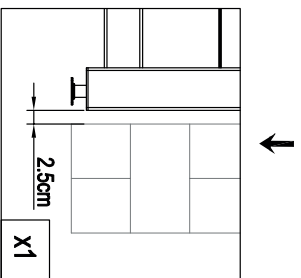
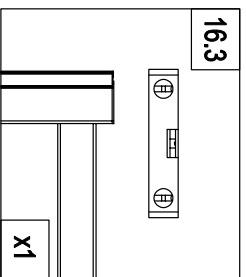
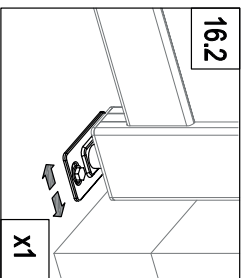
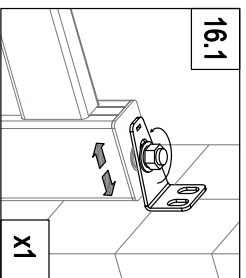
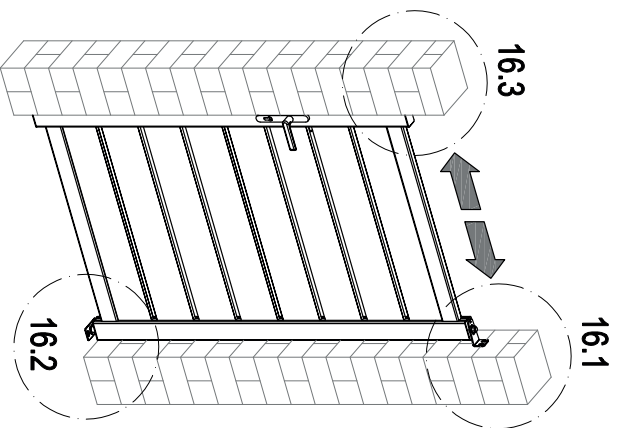



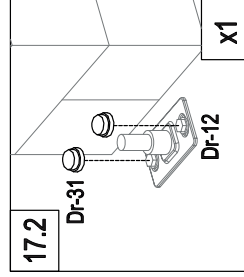
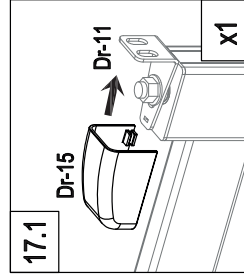
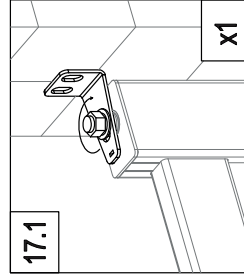
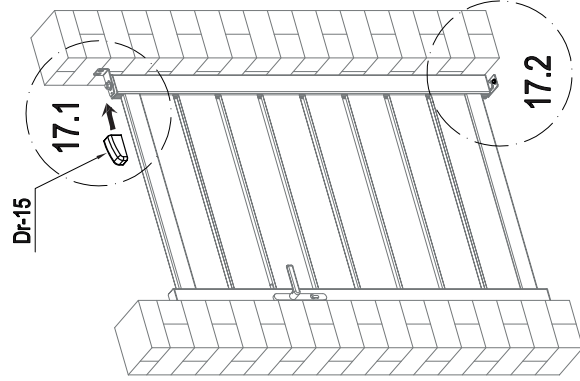

16

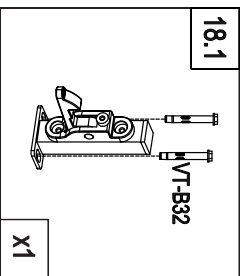
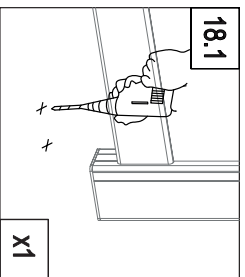
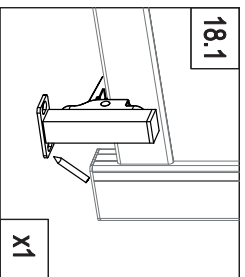
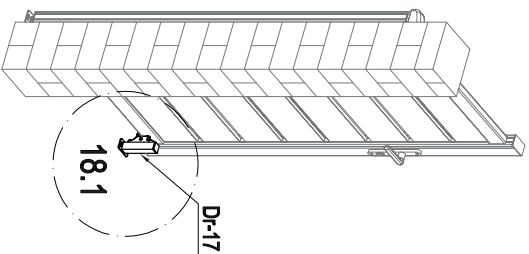

	1
	2



	VT-B32	2
	D-17	1



۲۷

