

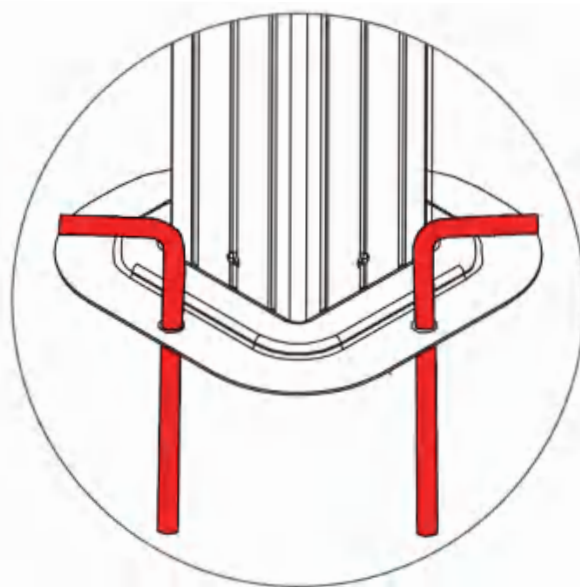

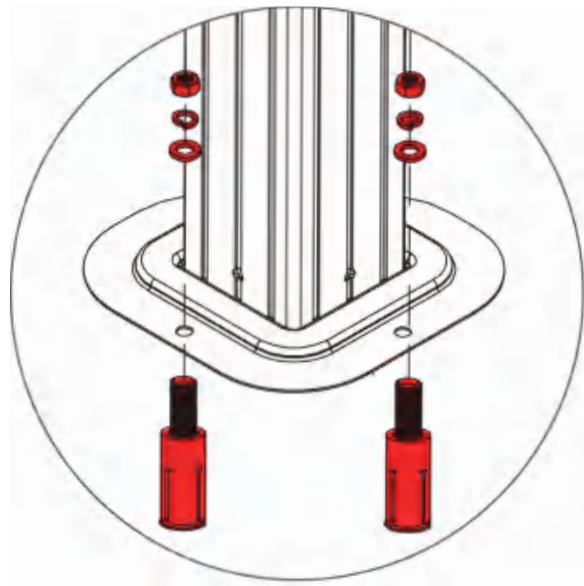







10X12 FT HARDTOP GAZEBO

1. Must use ground nails, ropes, and expansions screws for whichever ground you install on for stability to avoid devastating injuries for people inside or nearby and property damage caused by a collapsing gazebo.
2. Do not use this gazebo in high winds, heavy snow, or inclement weather. It is not designed to withstand strong gusts of wind, heavy snow accumulation, or other inclement weather. Must take precautions when the wind speed exceeds 25Mph, and clear snow when it accumulates more than 2 inches.
3. Before use, thoroughly inspect the gazebo to make sure all bolts, nuts, and buckles have been completely tightened and securely fastened.
4. Warranty does not cover damages, losses, or injuries resulting from improper installation, misuse, not using stability accessories mentioned above, non snow cleaning, failure to take precautionary measures, etc.





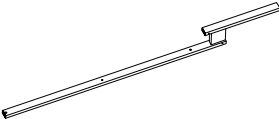





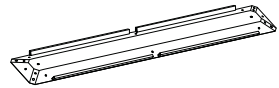
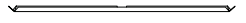
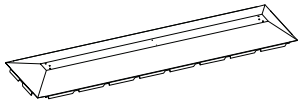





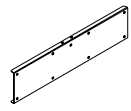

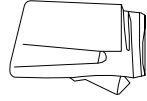

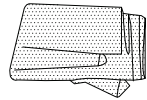
ASSEMBLY INSTRUCTIONS

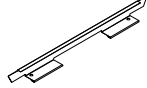



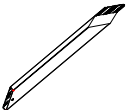

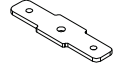





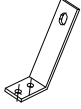

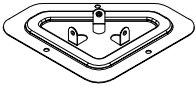



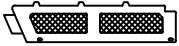
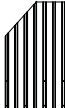
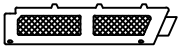
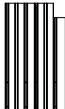



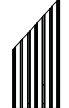

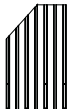
1. Two or more people are required for assembly.
2. A ladder and electric drill may be necessary.
3. Do not erect the structure in heavy winds or inclement weather.
4. Do not leave up this unit for extended periods of time, as it is not a permanent structure or designed to withstand sustained wind or rain. It is a temporary, portable shelter that shields you from sunlight and rain. The screens also block flying insects.
5. Do not use candles, matches, or any open flames near the tent.
6. To better align the screws for practical situations, do not fully tighten screws initially.
7. Professional installation is highly recommended.

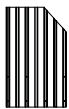
Item no.	Reference Image	Qty.
A		X4
B		X2
B1		X2
B2		X2
B3		X2
Ea		X4
Eb		X4
E1		X4
F1		X4

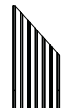













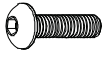

ASSEMBLY INSTRUCTIONS

Item no.	Reference Image	Qty.	Item no.	Reference Image	Qty.
F2		X4	L		X1
G1		X2	M		X1
G2		X2	N		X12
G3		X2	N1		X4
G4		X2	P		X4
G5		X2	T		X4
G6		X2	T1		X4
G7		X2	Z		X56
G8		X2	Z1		X24
H		X4	U		X104
H1		X4	W		X4
K		X4	W1		X4
K1		X4	W2		X4

ASSEMBLY INSTRUCTIONS

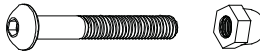
Item no.	Reference Image	Qty.	Item no.	Reference Image	Qty.
W3		X4	Sa		X2
J		X4	R1		X2
Y		X104	R2		X2
V1		X2	R3		X2
V2		X2	R4		X2
V3		X2	R5		X2
Q1		X2	R6		X2
Q2		X2	R7		X2
Q3		X2	R8		X2
Q4		X2	S1		X2
Q5		X2	S2		X2
Q6		X2	S3		X2
S		X2	S4		X2

ASSEMBLY INSTRUCTIONS

Item no.	Reference Image	Qty.	Item no.	Reference Image	Qty.
①	 M6X16mm	X144	⑨		X12
②	 M6X23mm	X64	⑩	 M5X12mm	X20
③	 M6X25mm	X8	⑪		X2
④	 ST4.8X12mm	X24	⑫	 S4	X1
⑤	 M6X10mm	X8	⑬	 S5 S6	X1
⑥	 M6X42mm	X4	⑭		X12
⑦	 M6X47mm	X28	⑯		X12
⑧	 M6X15mm	X16	⑰		X4
			⑱		X4

ASSEMBLY INSTRUCTIONS

1

X4



Ⓐ 4pcs

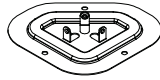

Ⓝ 4pcs



① 12pcs

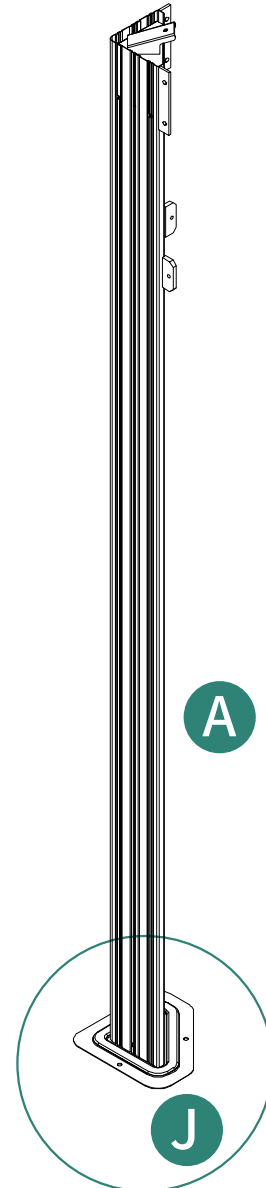
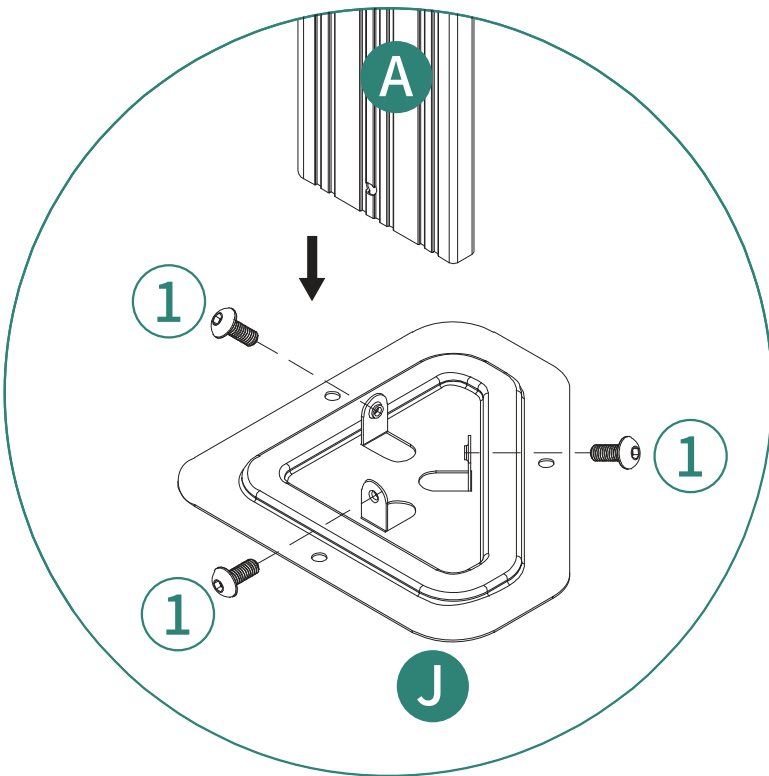

ASSEMBLY INSTRUCTIONS

2

X2

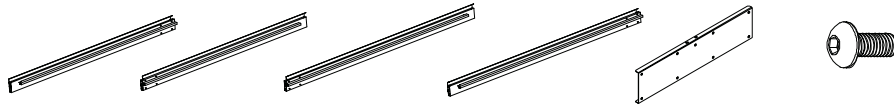

Ⓑ2pcs Ⓑ12pcs Ⓑ22pcs Ⓑ32pcs Ⓟ4pcs ①32pcs

When connecting B and B1 via P, B2 and B3 via P, make sure that 1 holes on part P (as shown in the picture) should be facing upwards. Do not install it upside down.

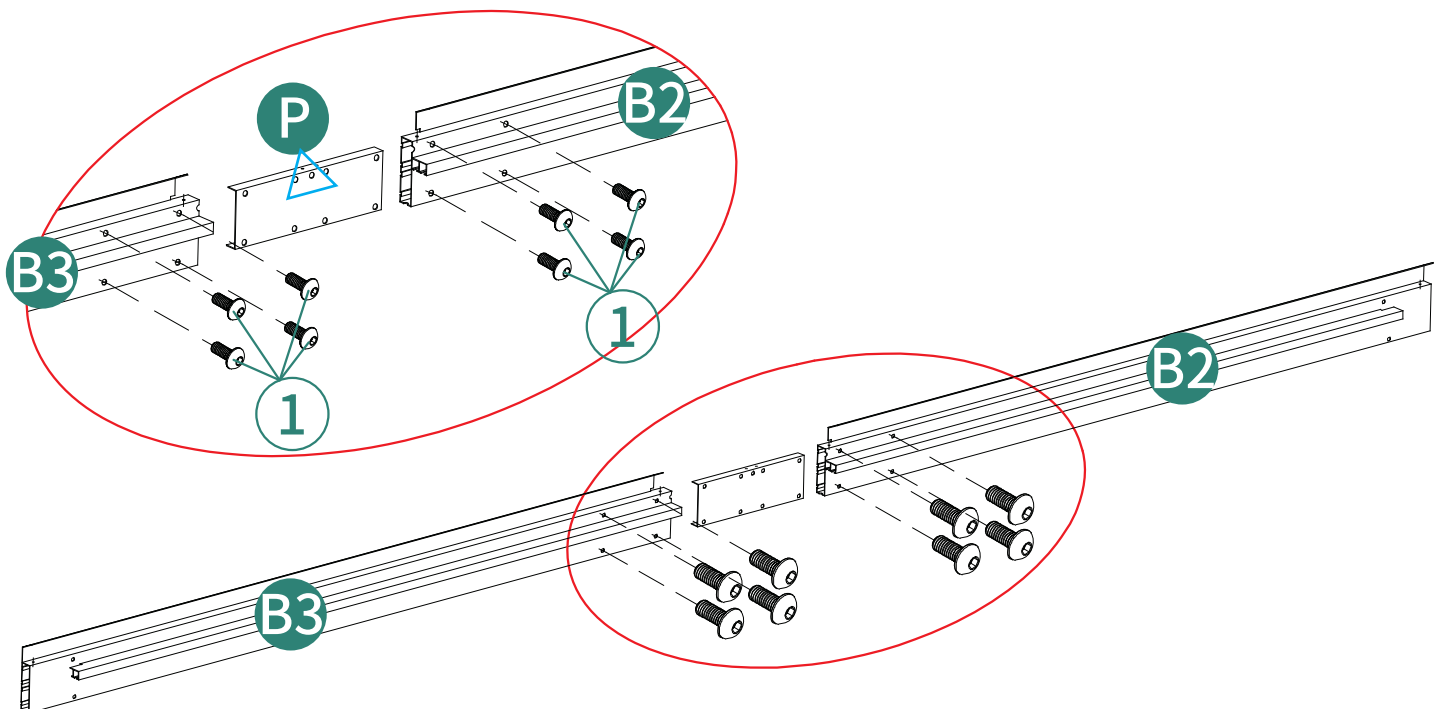
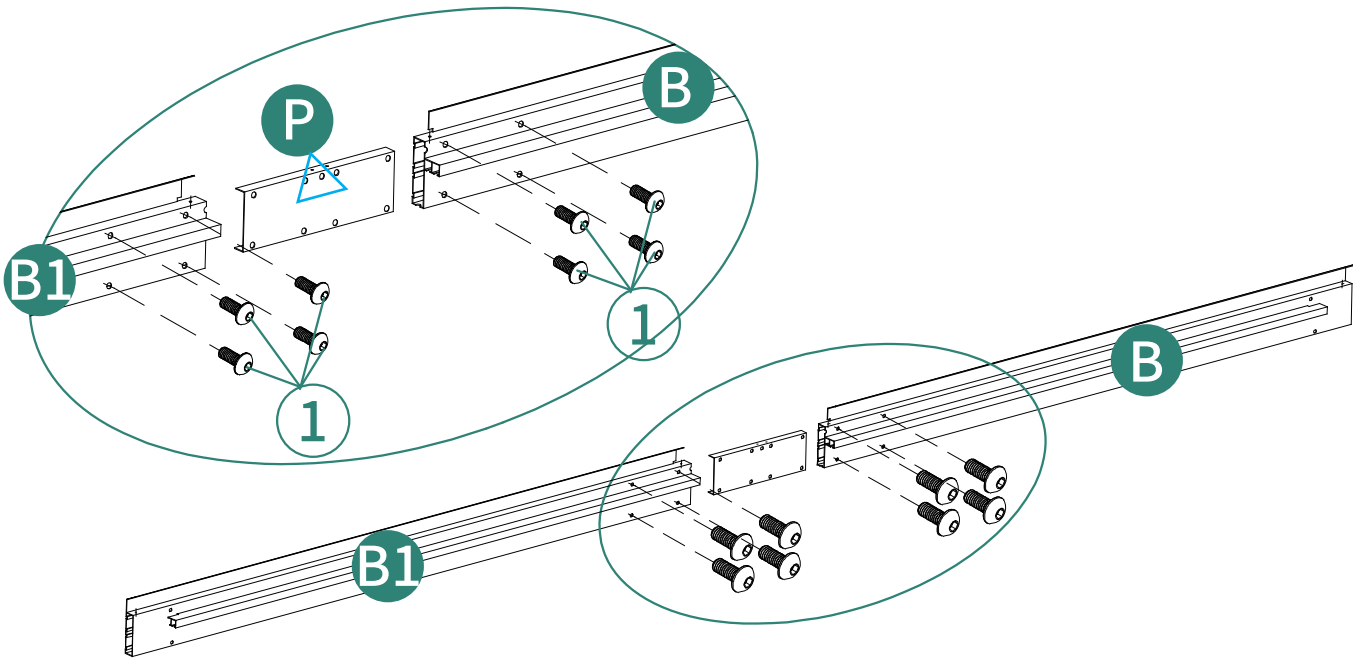

ASSEMBLY INSTRUCTIONS

3



Ⓢ104pcs

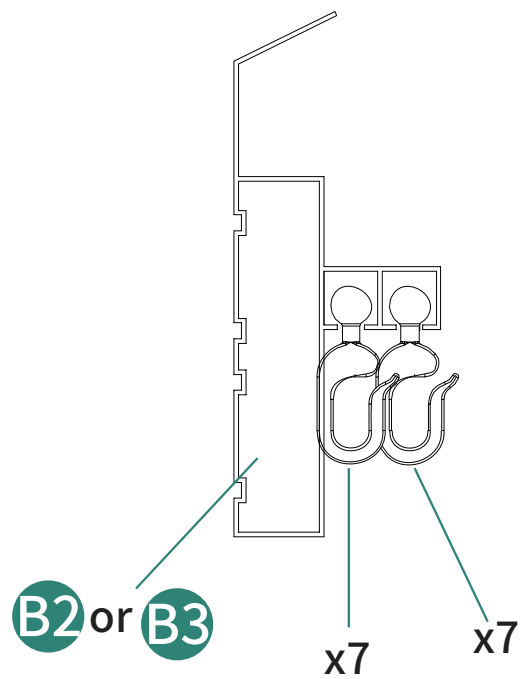
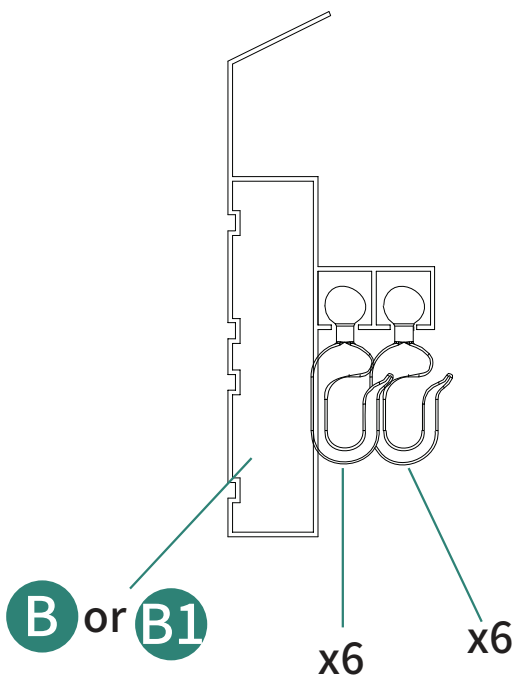
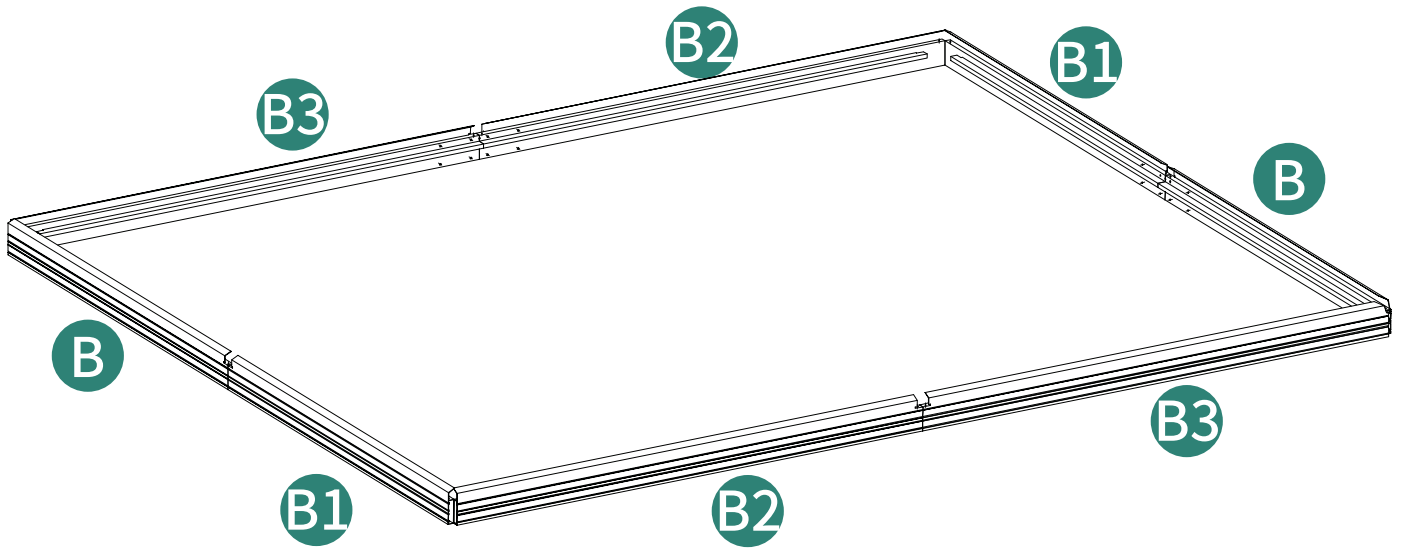

ASSEMBLY INSTRUCTIONS

4

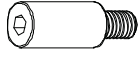

① 16pcs

⑧ 16pcs

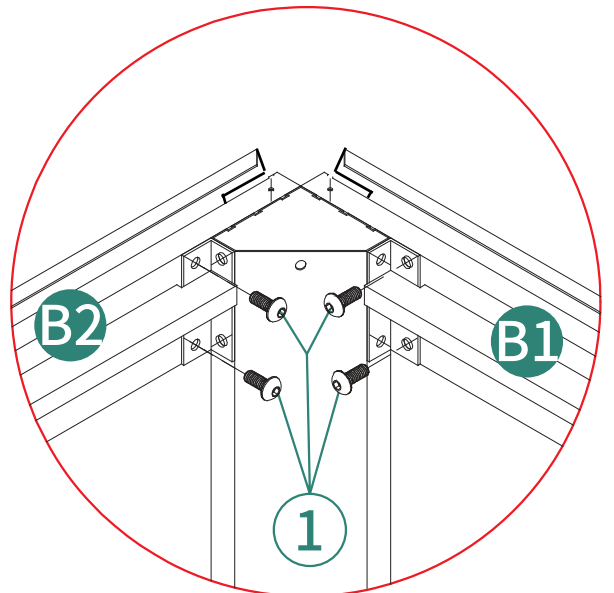
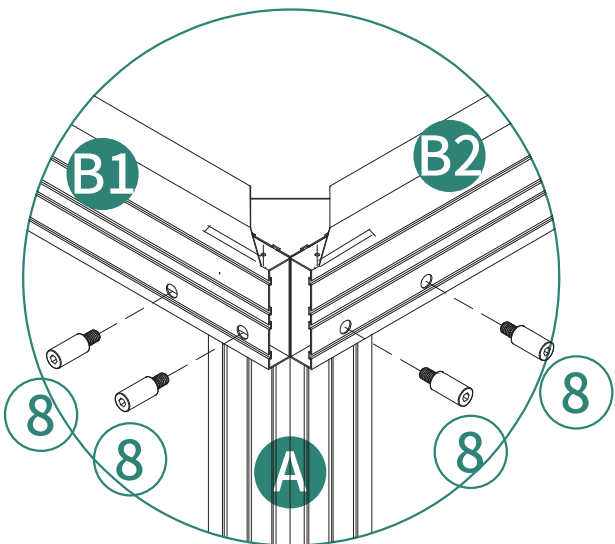
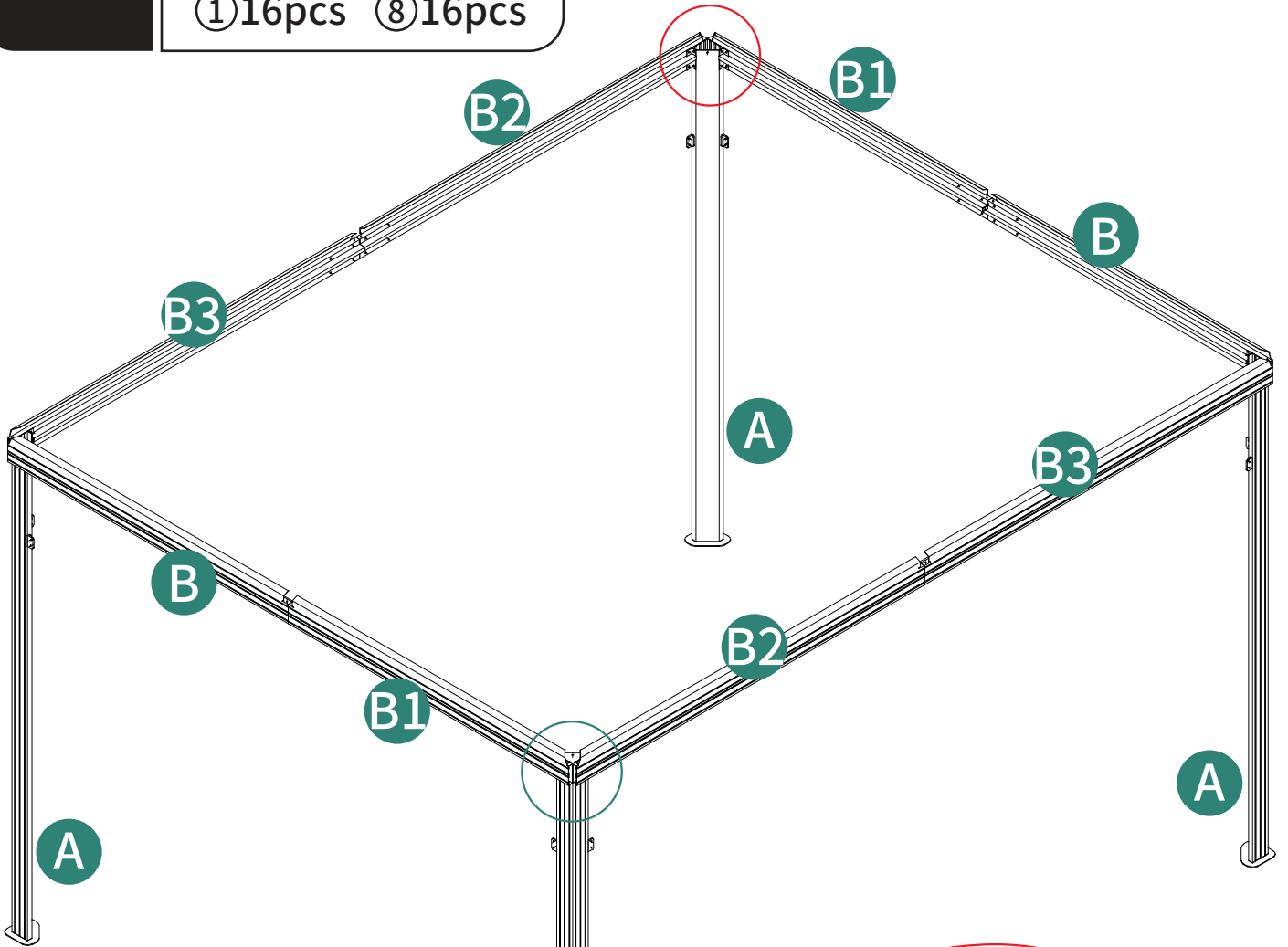

ASSEMBLY INSTRUCTIONS

5



(H) 4pcs



(H1) 4pcs



(1) 16pcs

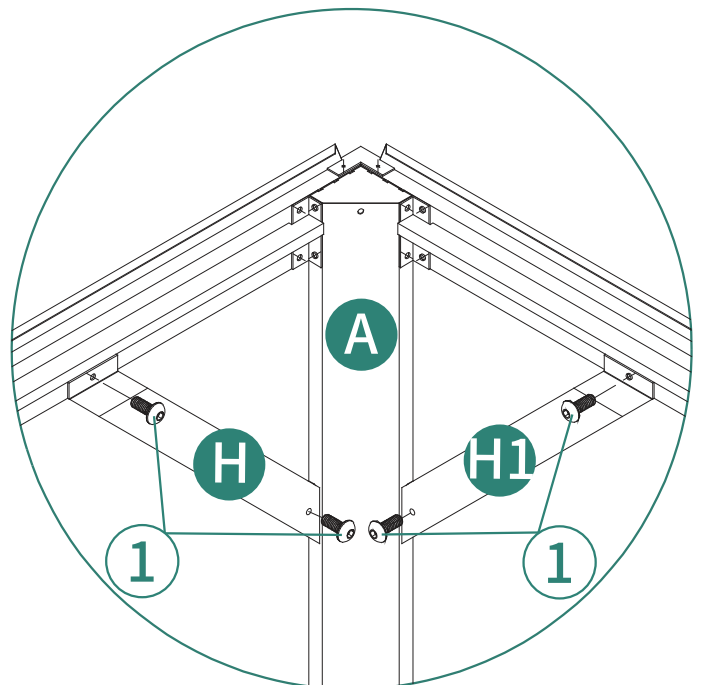
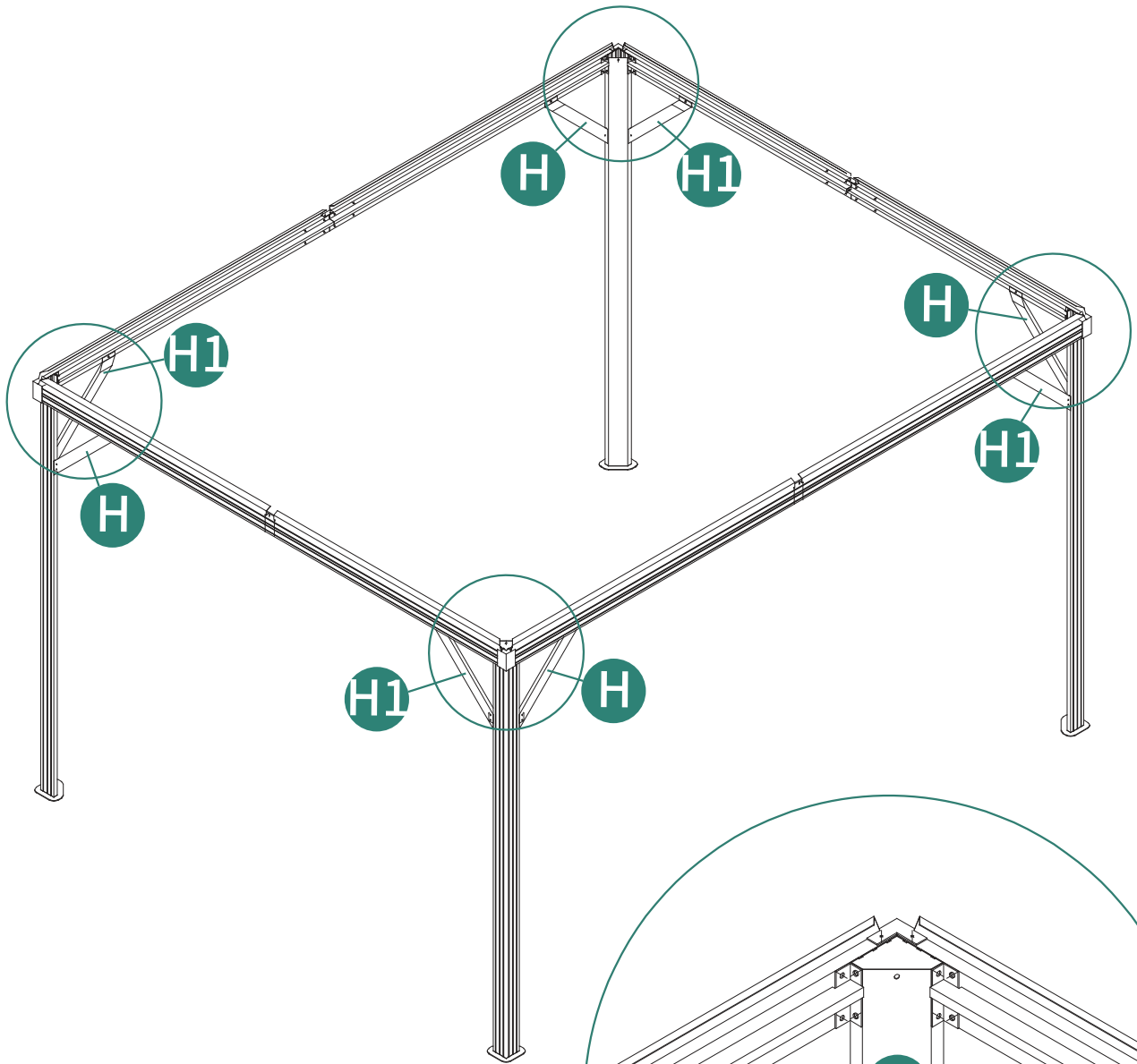

ASSEMBLY INSTRUCTIONS

6



(K) 4pcs



(K1) 4pcs



(4) 24pcs



(10) 4pcs

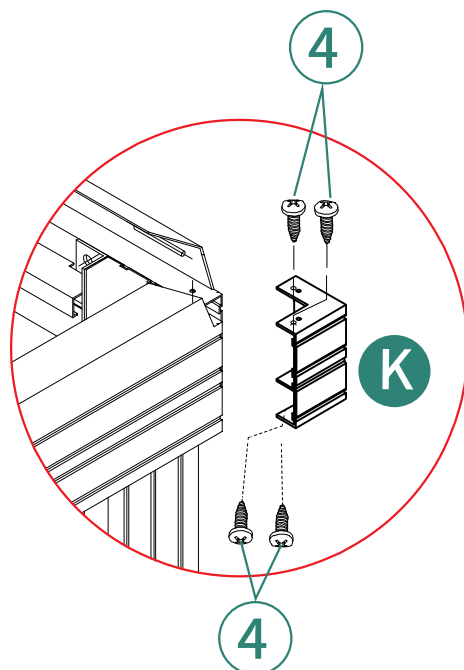
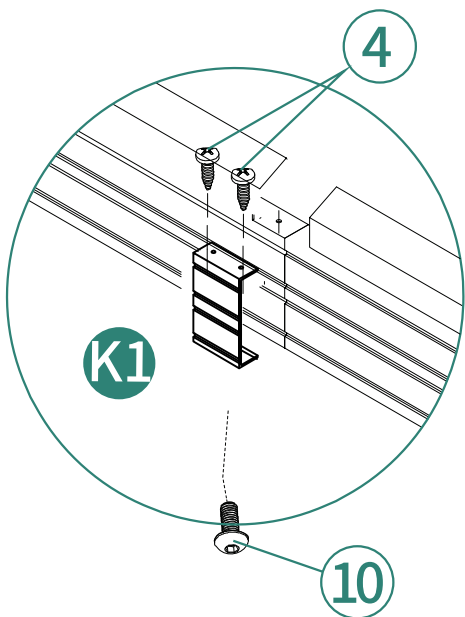
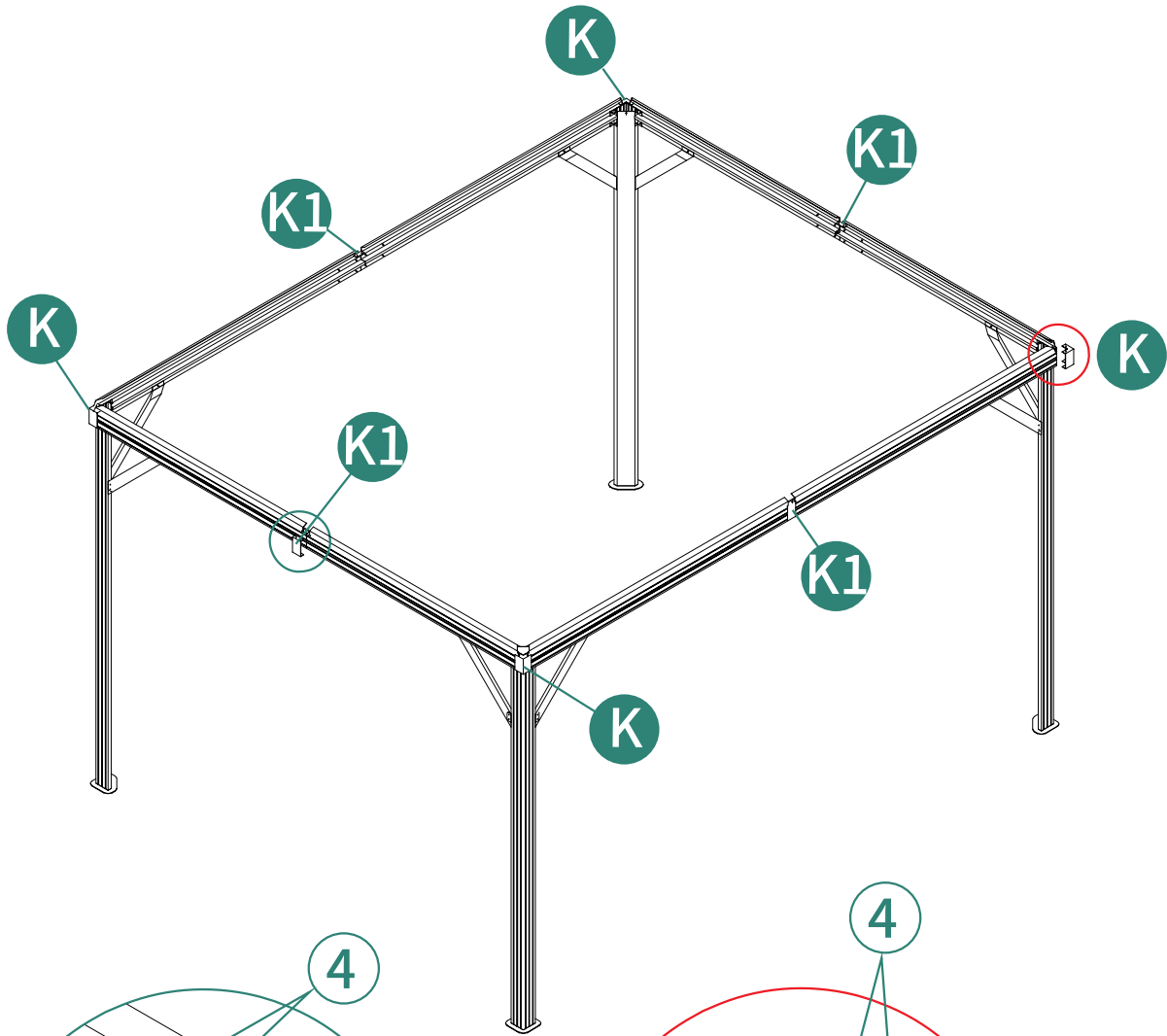

ASSEMBLY INSTRUCTIONS

7

X4

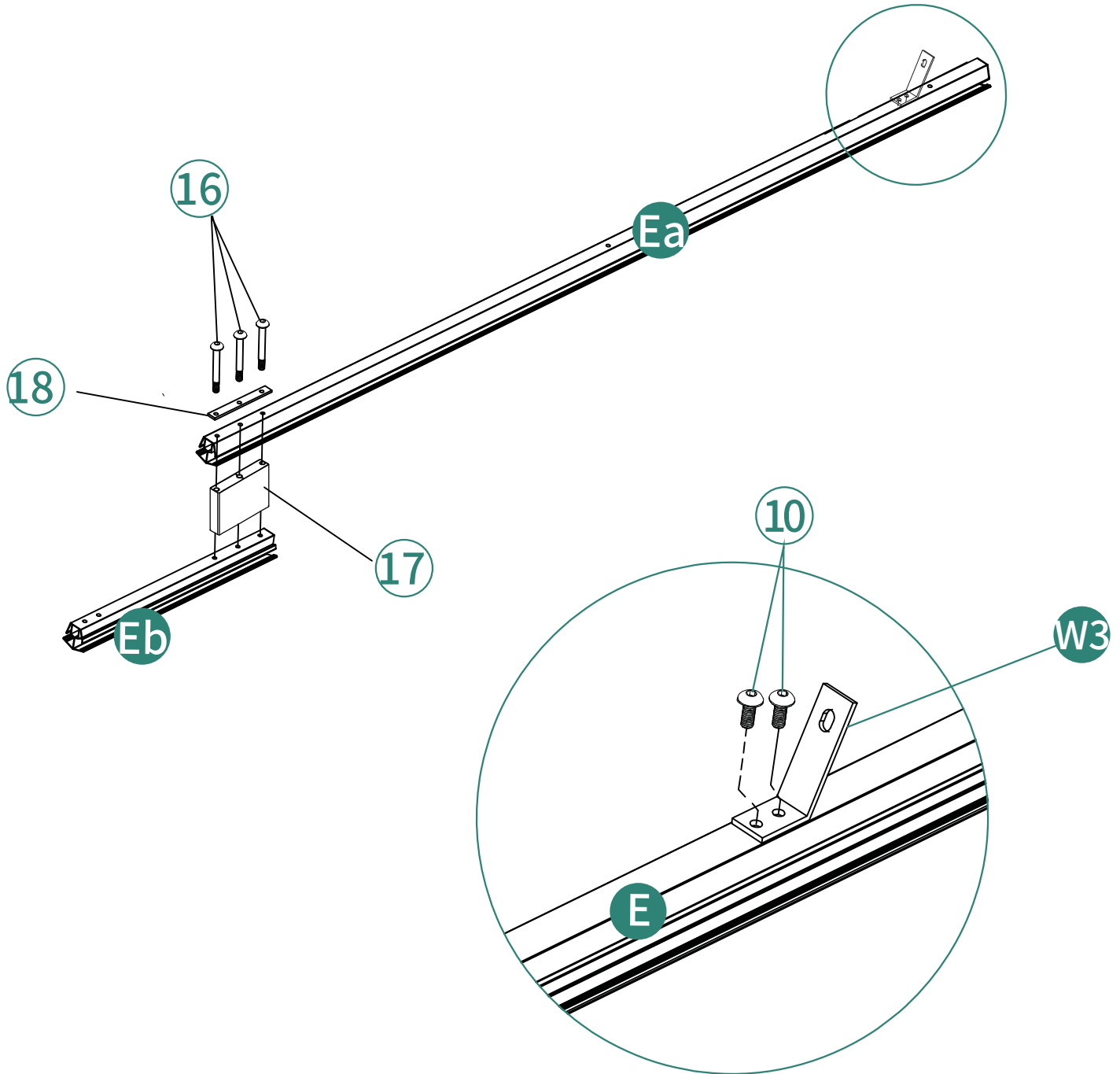
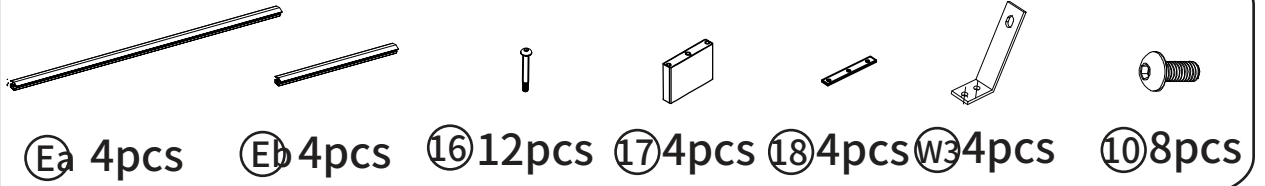

ASSEMBLY INSTRUCTIONS

8

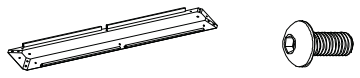

Ⓛ 1pc ① 8pcs

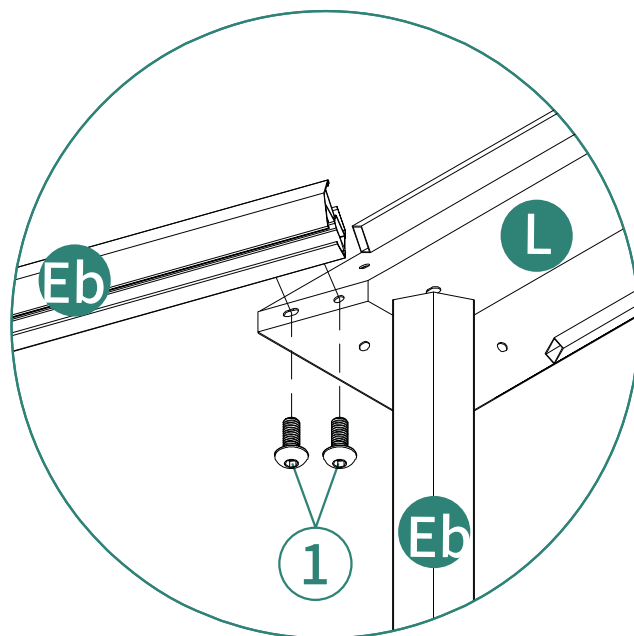
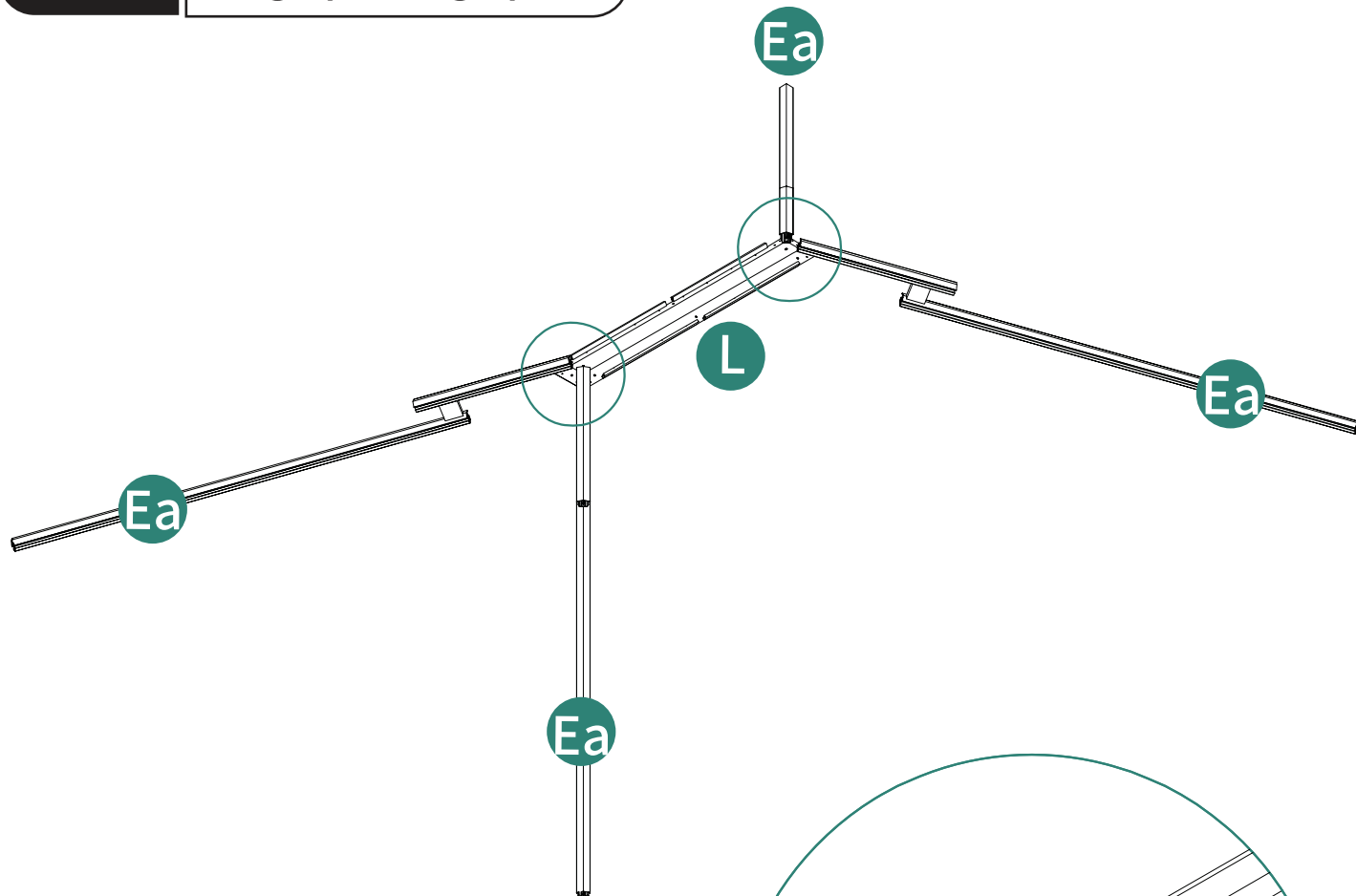

ASSEMBLY INSTRUCTIONS

9



① 4pcs

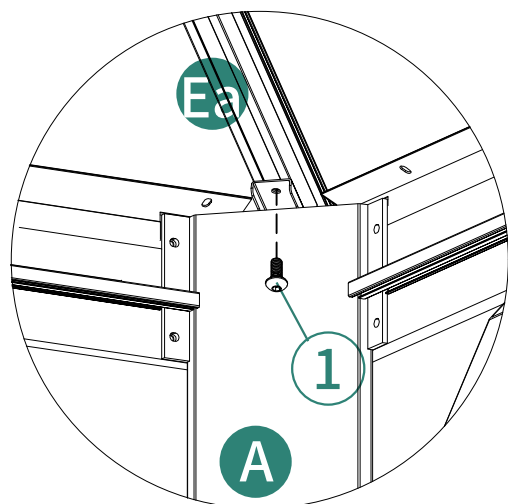
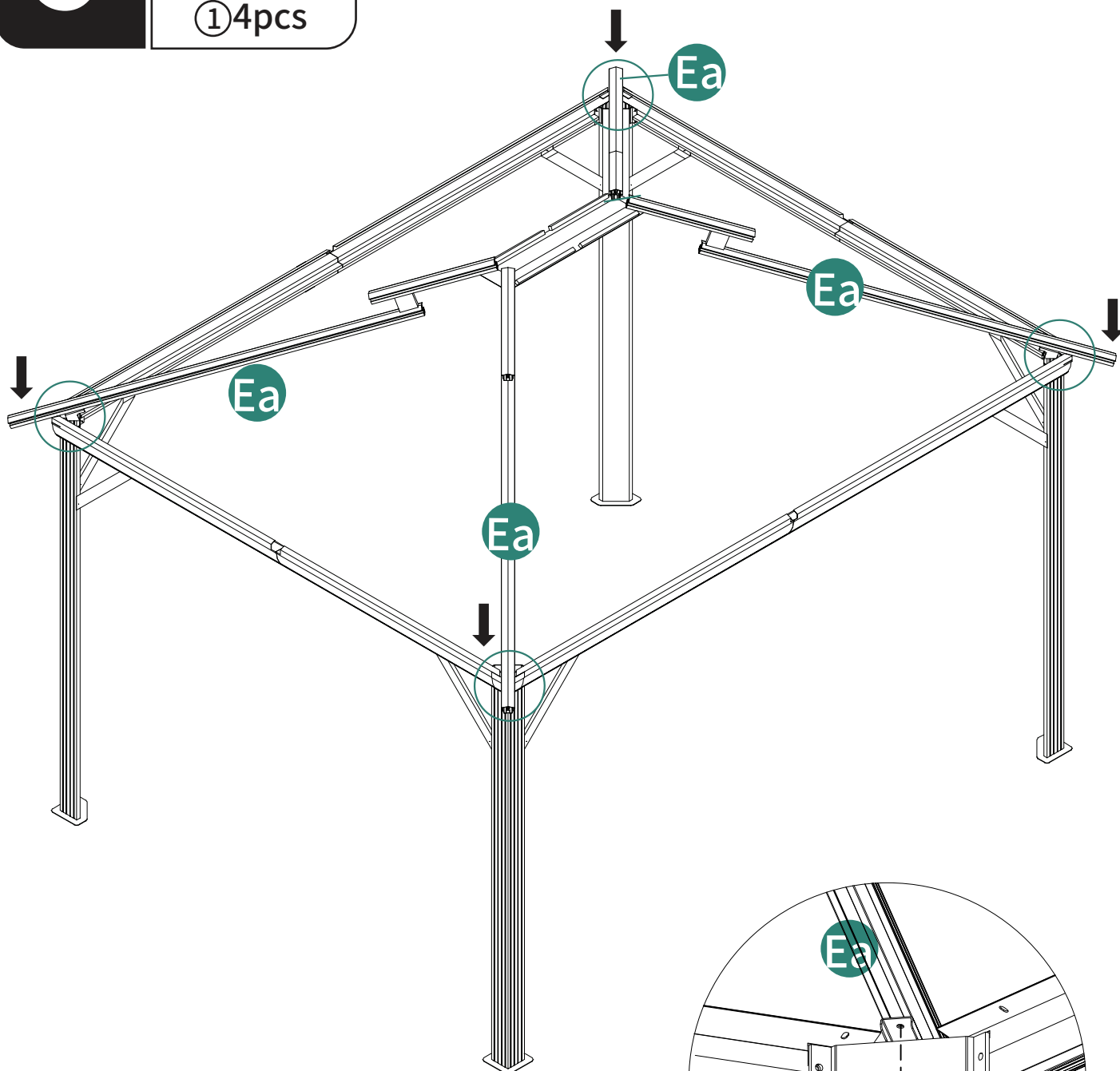

ASSEMBLY INSTRUCTIONS

10
X4

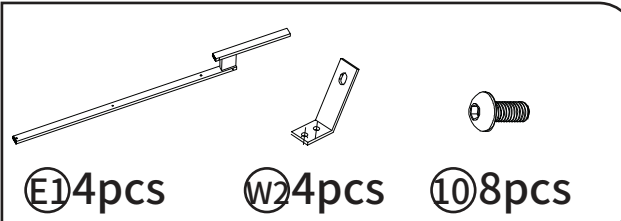

Ⓔ1 4pcs Ⓔ2 4pcs 10 8pcs

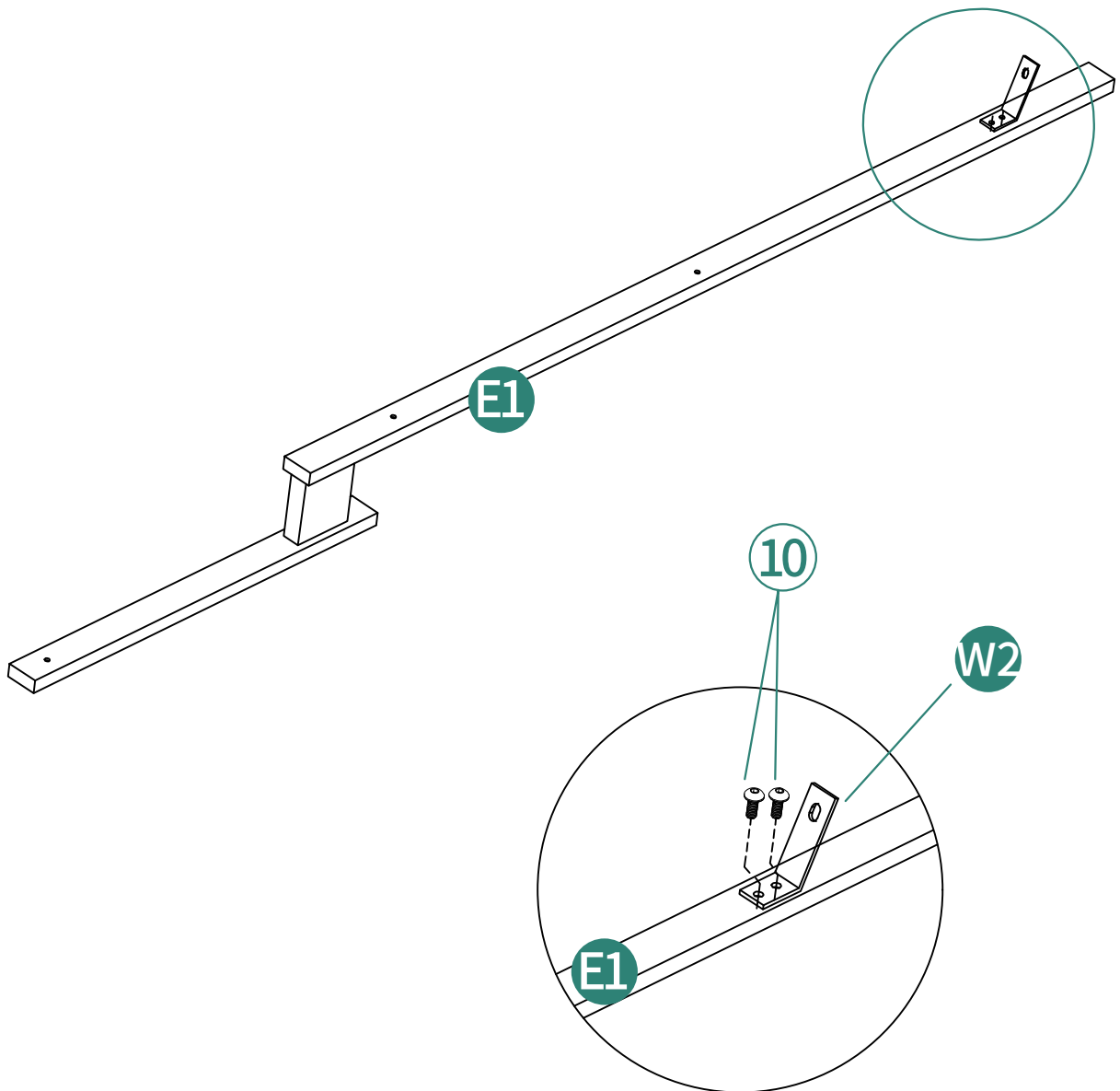

ASSEMBLY INSTRUCTIONS

11



① 8pcs

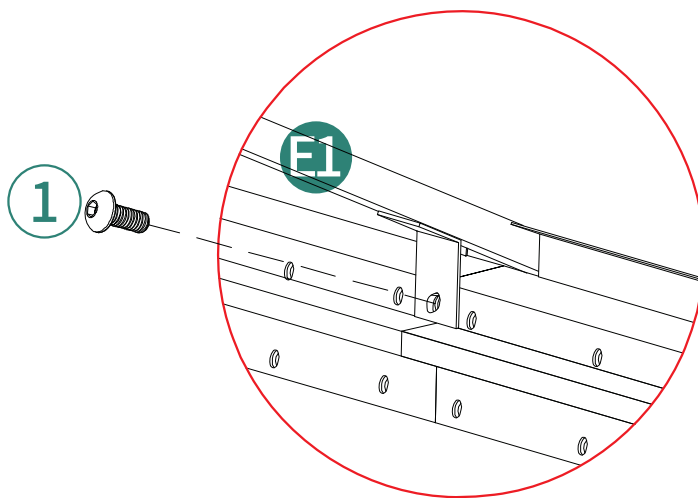
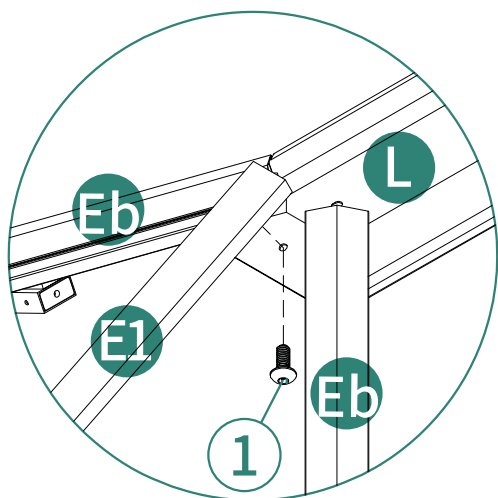
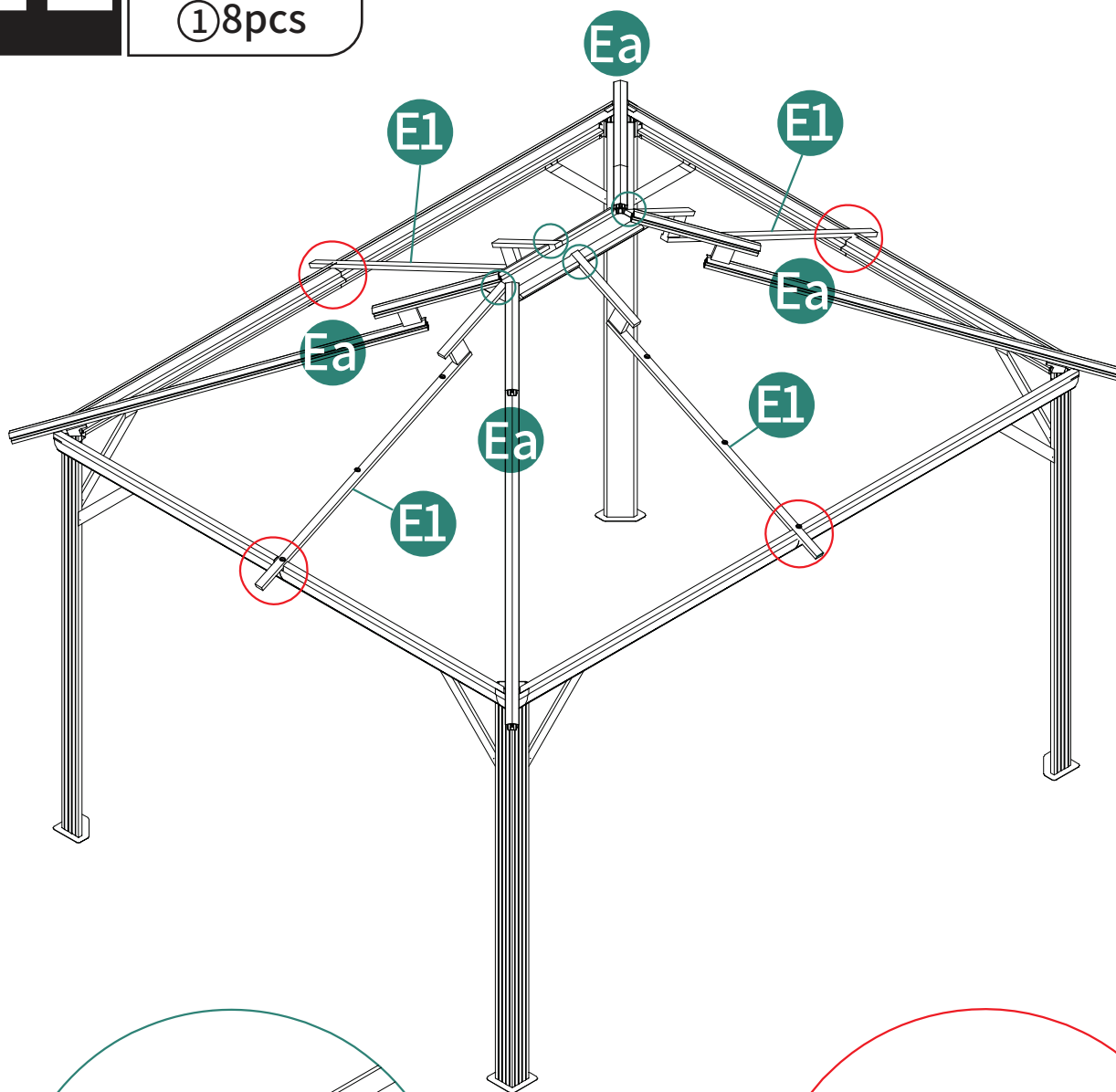

ASSEMBLY INSTRUCTIONS

12

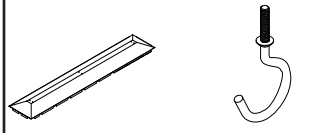

Ⓜ 1pc ⑪ 2pcs

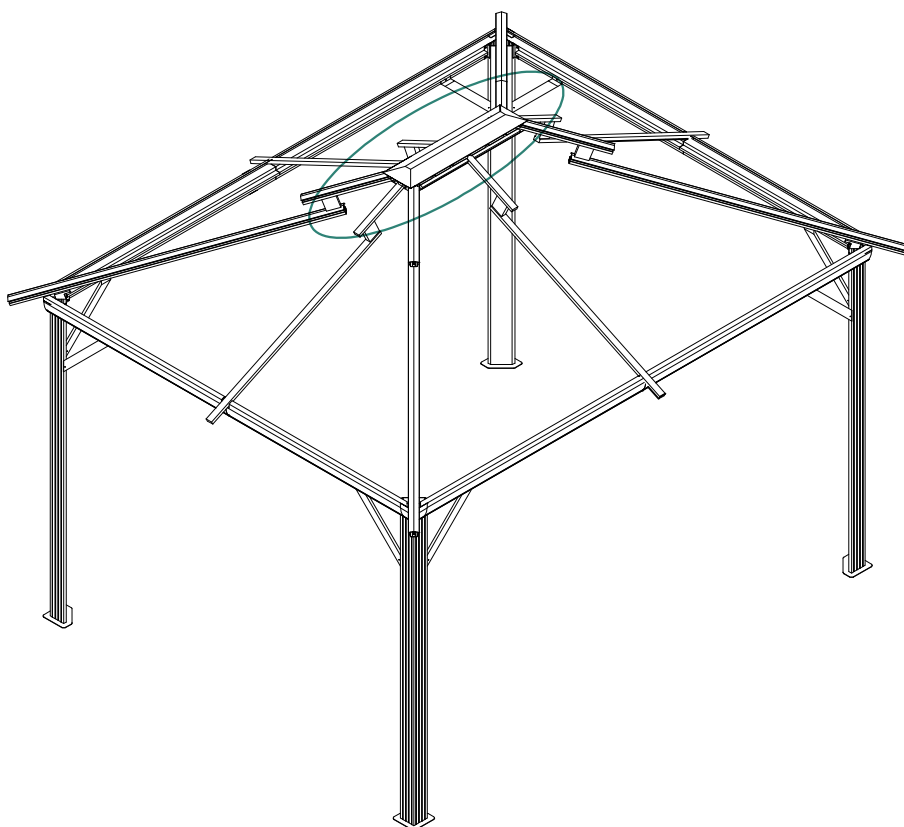
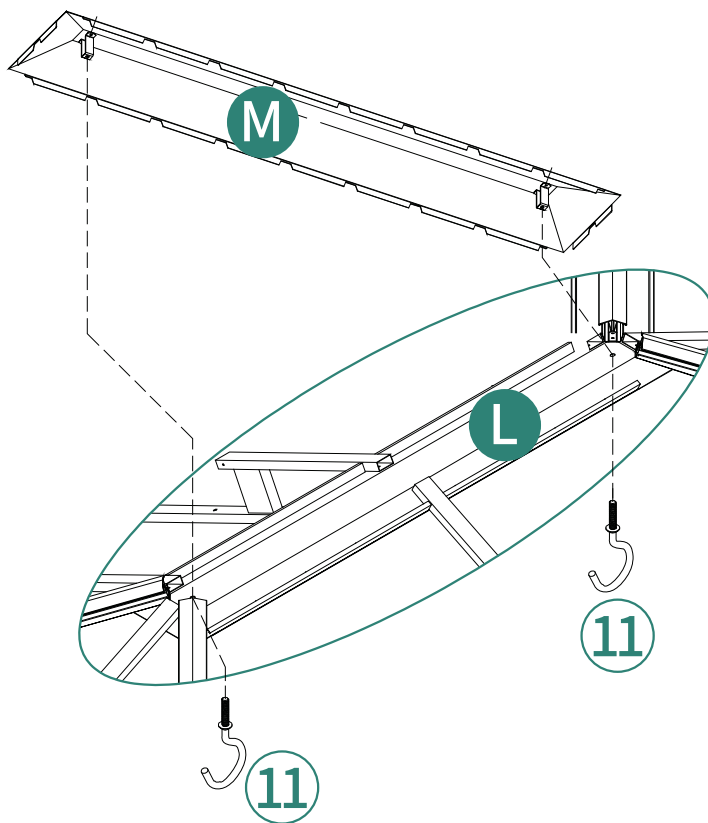

ASSEMBLY INSTRUCTIONS

13

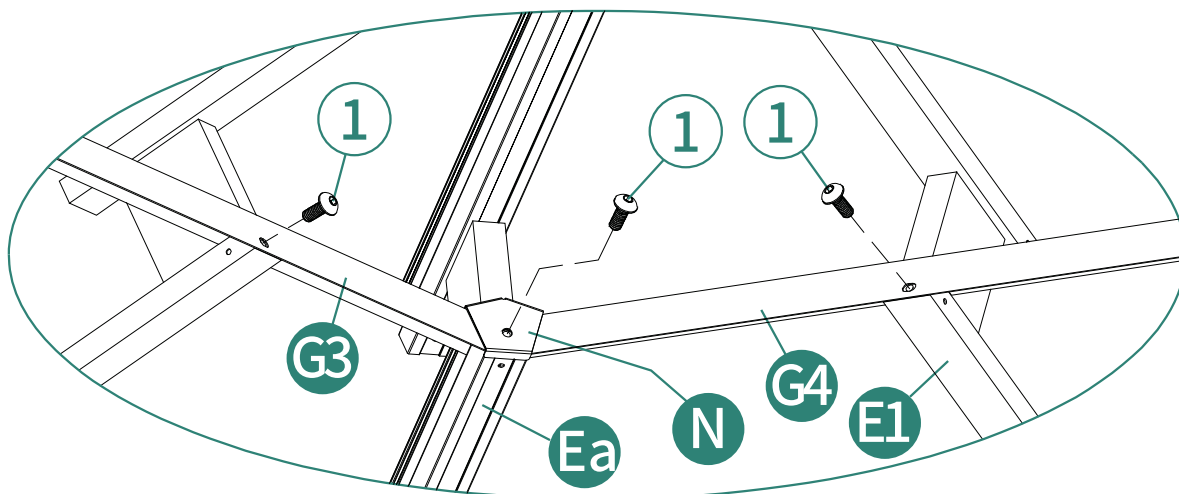
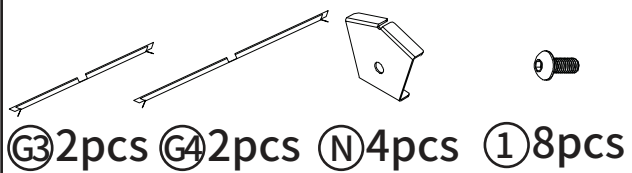

Do not tighten the screw 1 before completing step 19.
It's view from the bottom inside gazebo.

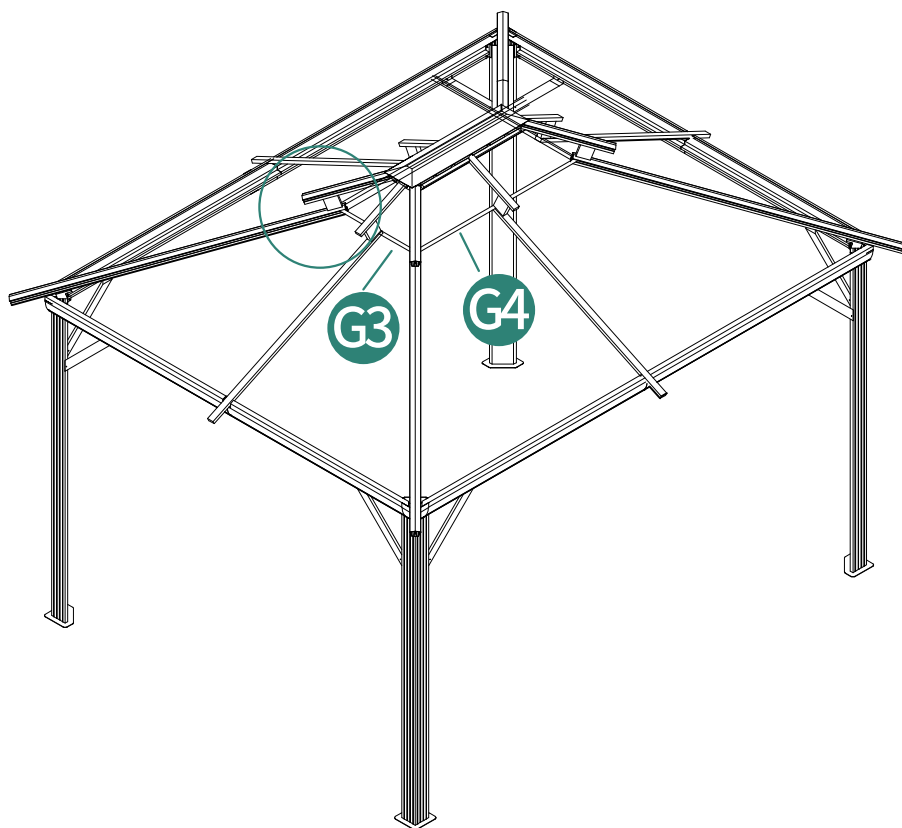

ASSEMBLY INSTRUCTIONS

14

X2

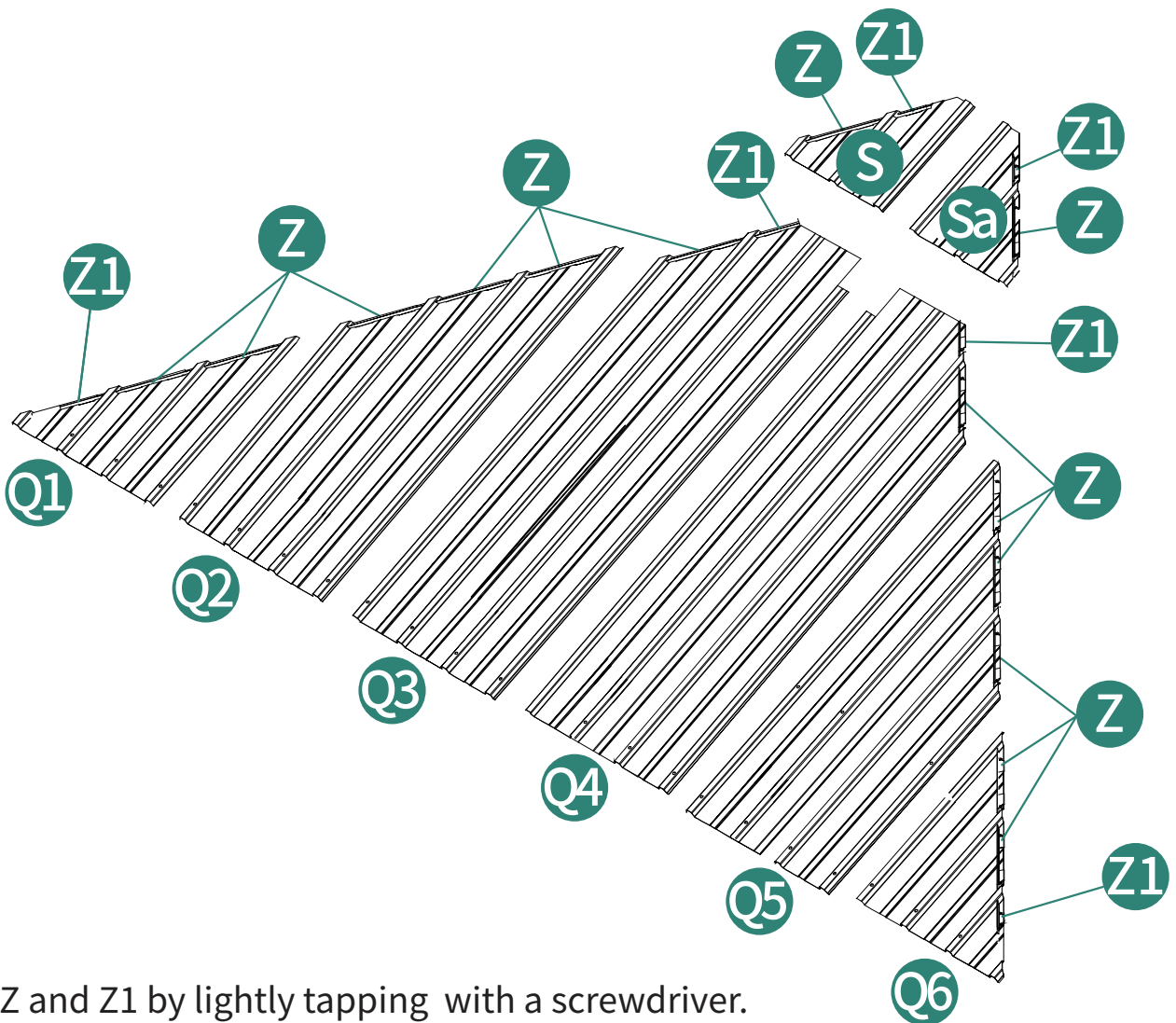
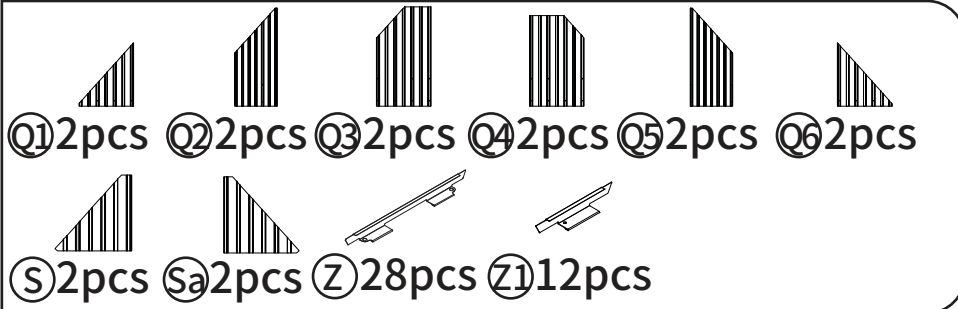

Attach Z and Z1 by lightly tapping with a screwdriver.

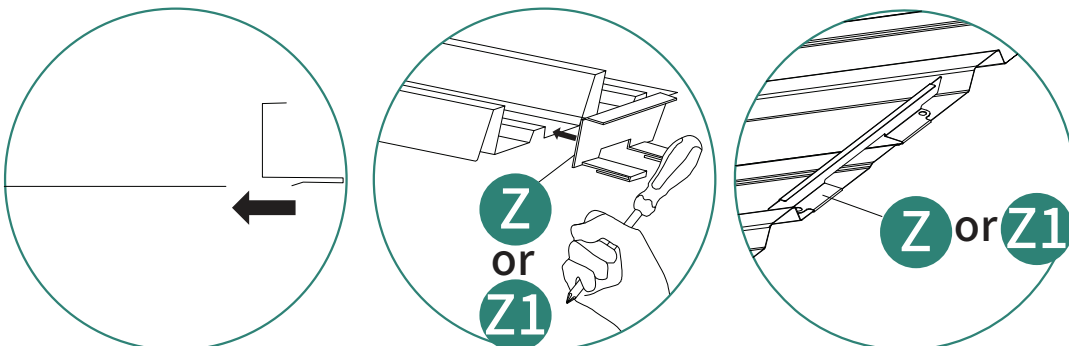

ASSEMBLY INSTRUCTIONS

15

X2

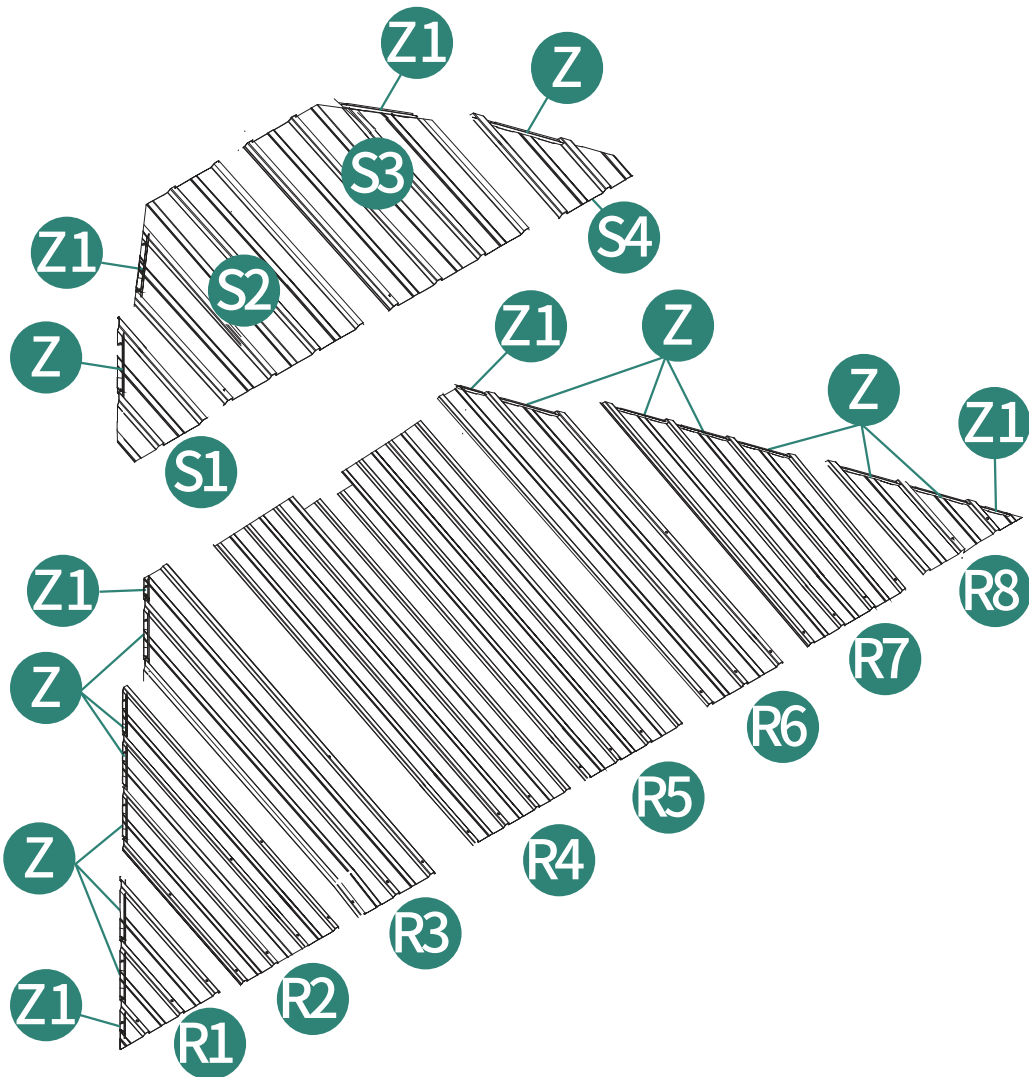
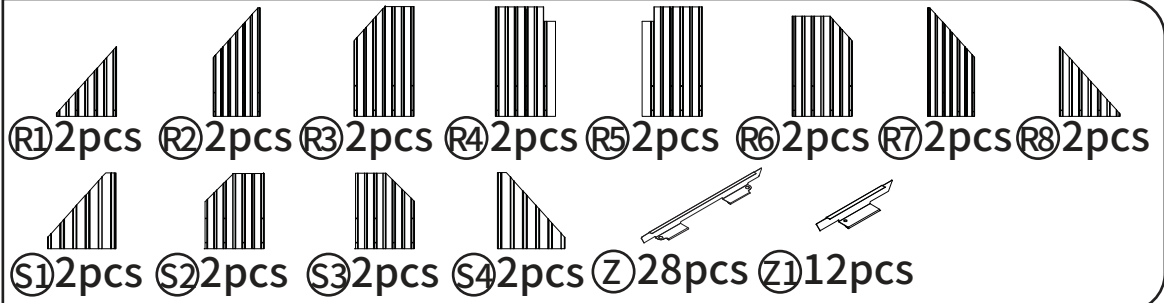

Attach Z and Z1 by lightly tapping with a screwdriver.

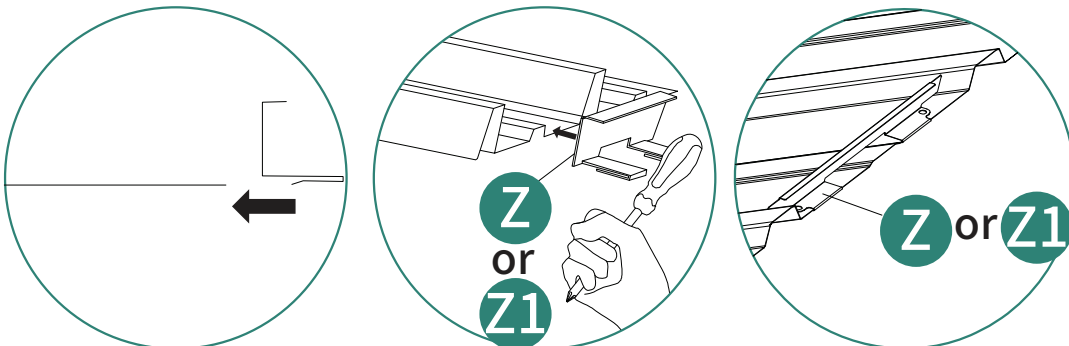

16

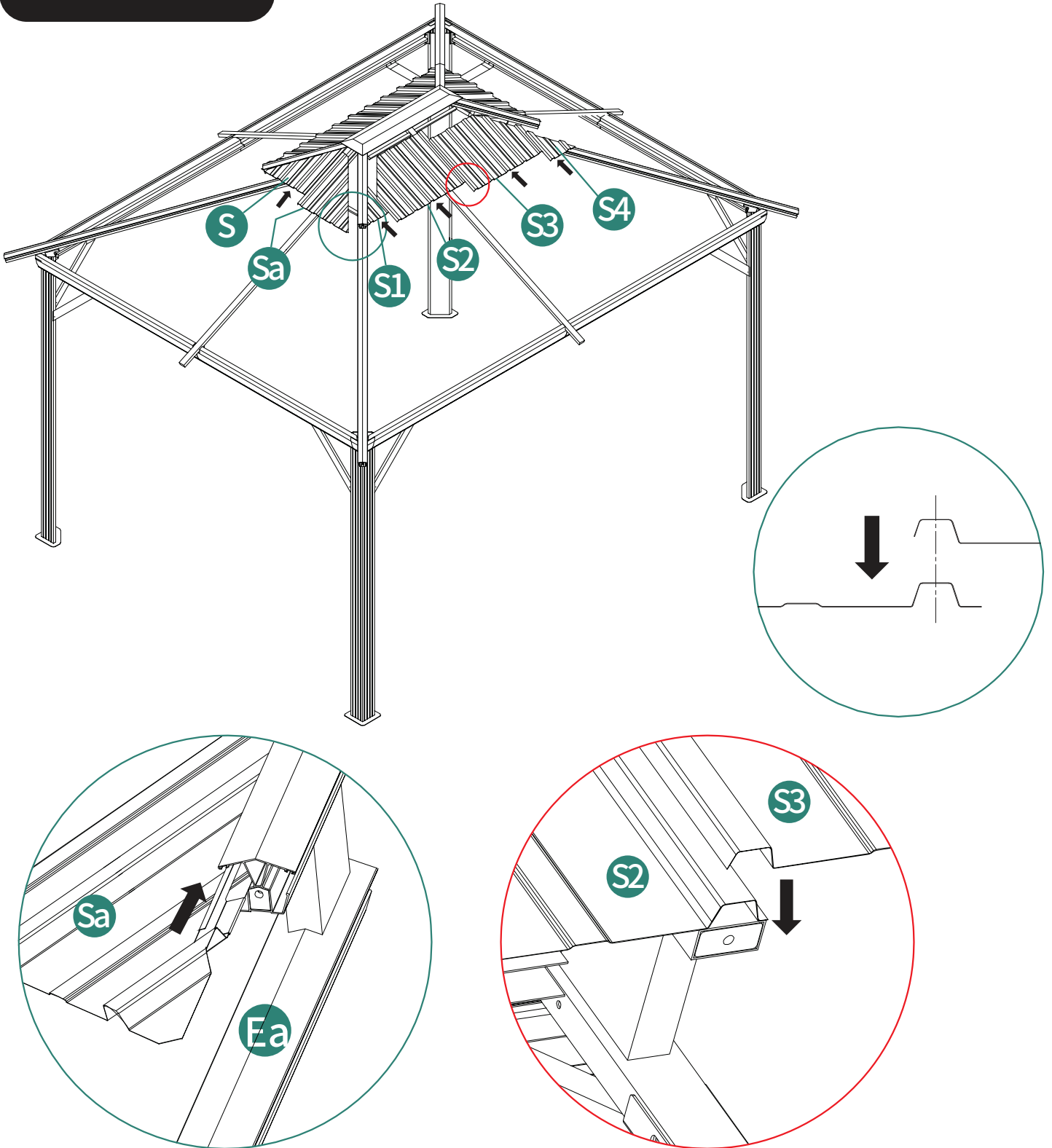

ASSEMBLY INSTRUCTIONS

17

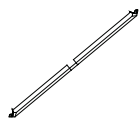

G1 2pcs

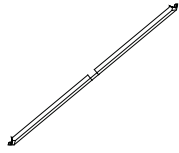

G2 2pcs



N 4pcs



1 8pcs

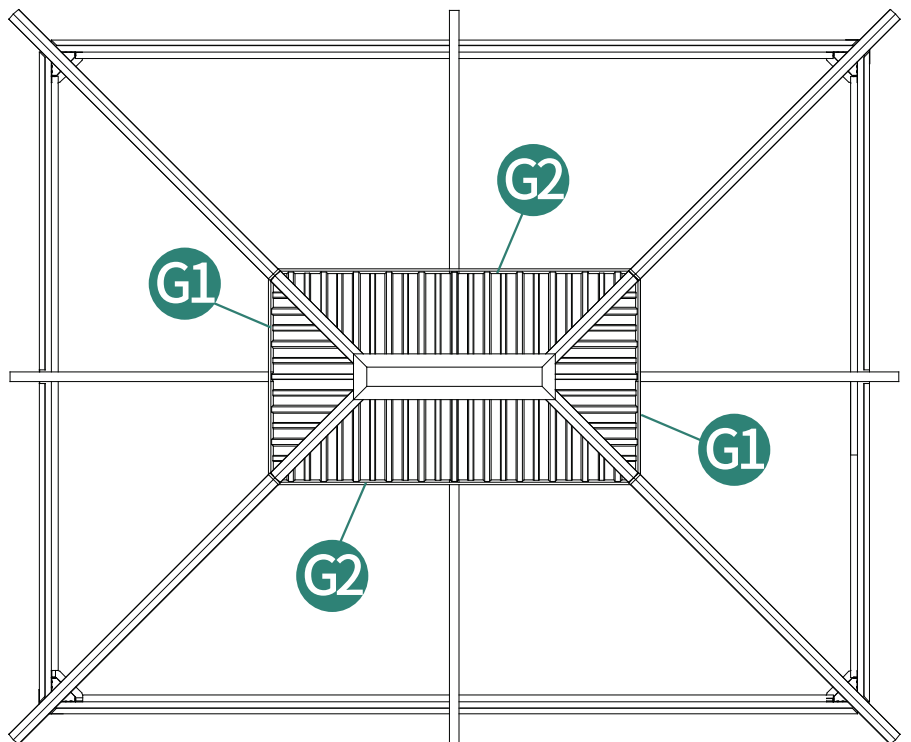
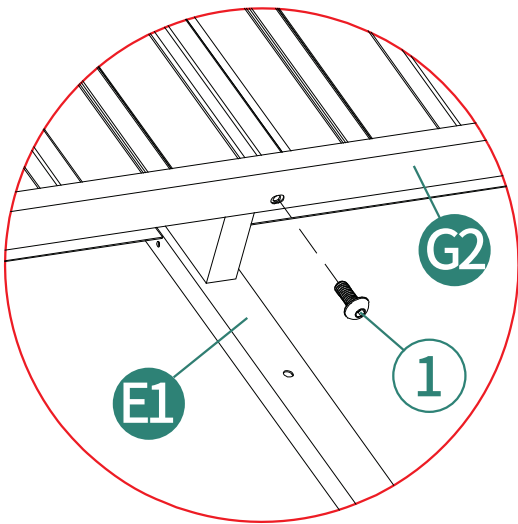
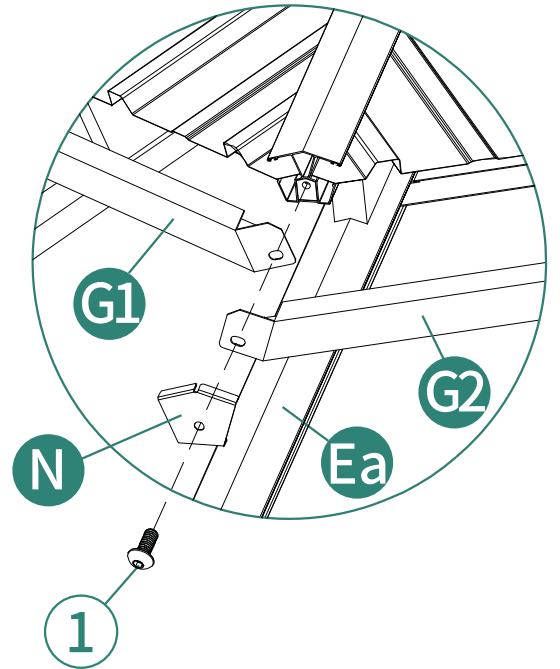
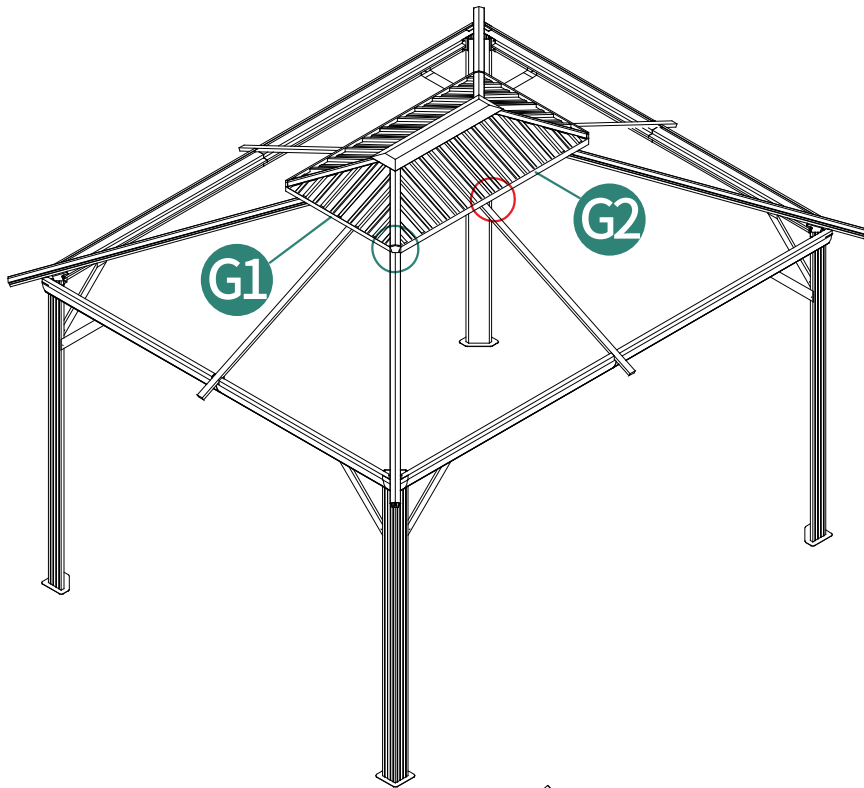

ASSEMBLY INSTRUCTIONS

18

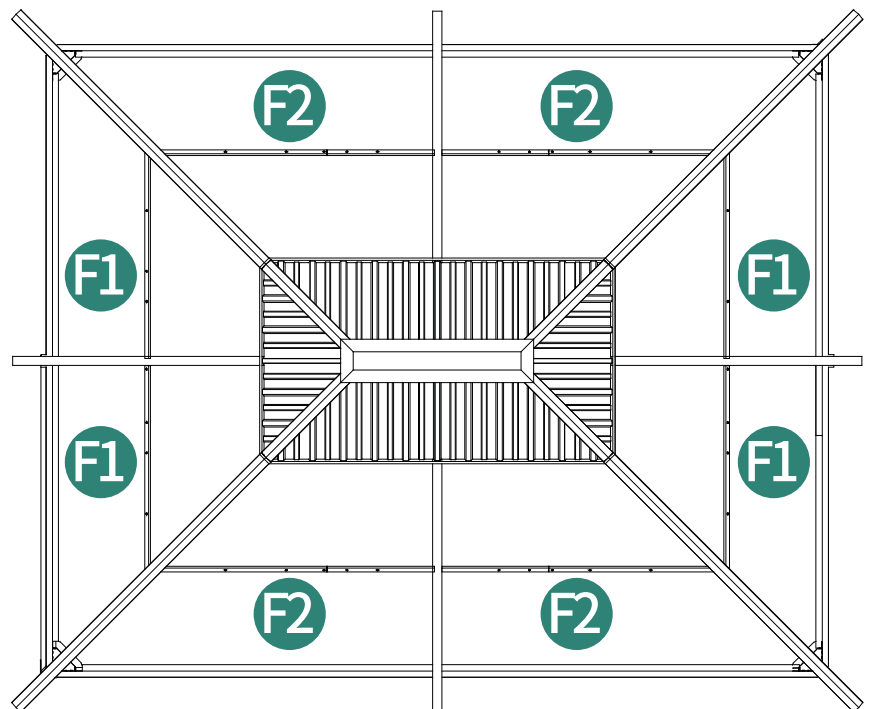
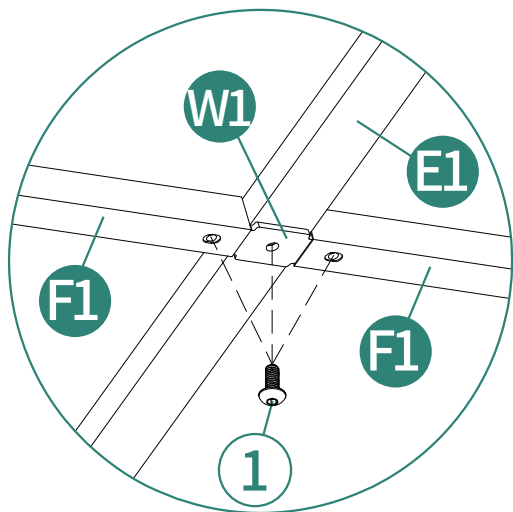
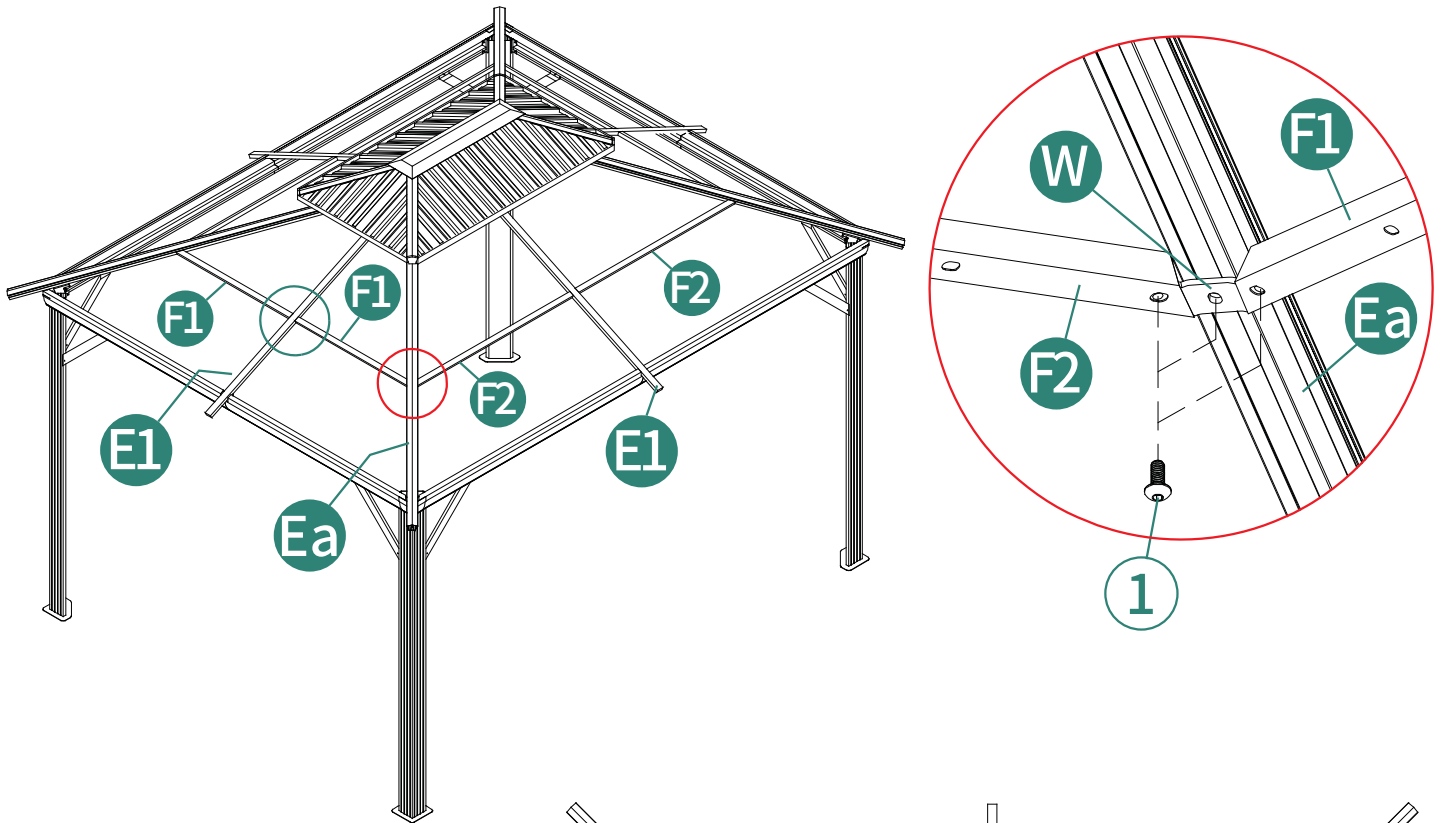
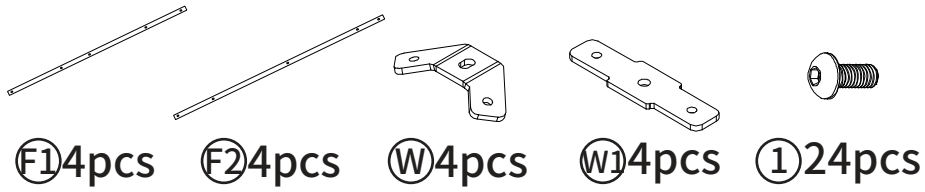

ASSEMBLY INSTRUCTIONS

19

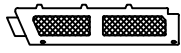

V1 2pcs



V2 2pcs

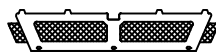

V3 2pcs



5 8pcs

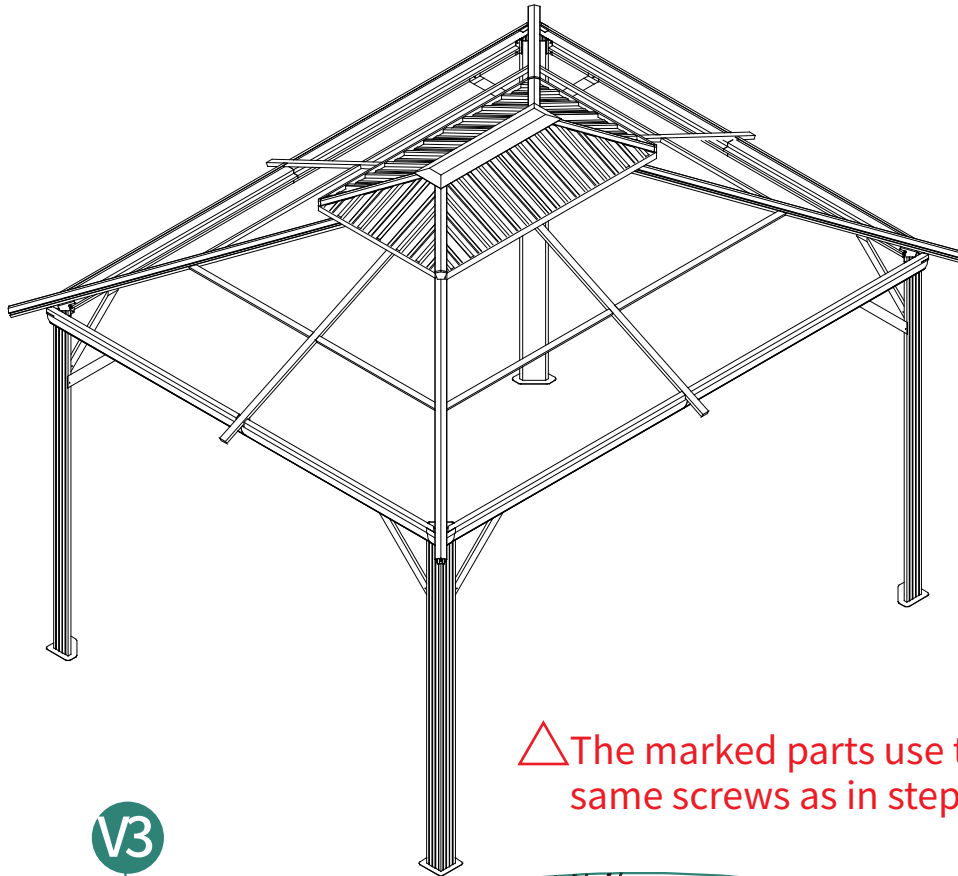

△ The marked parts use the same screws as in step 13.

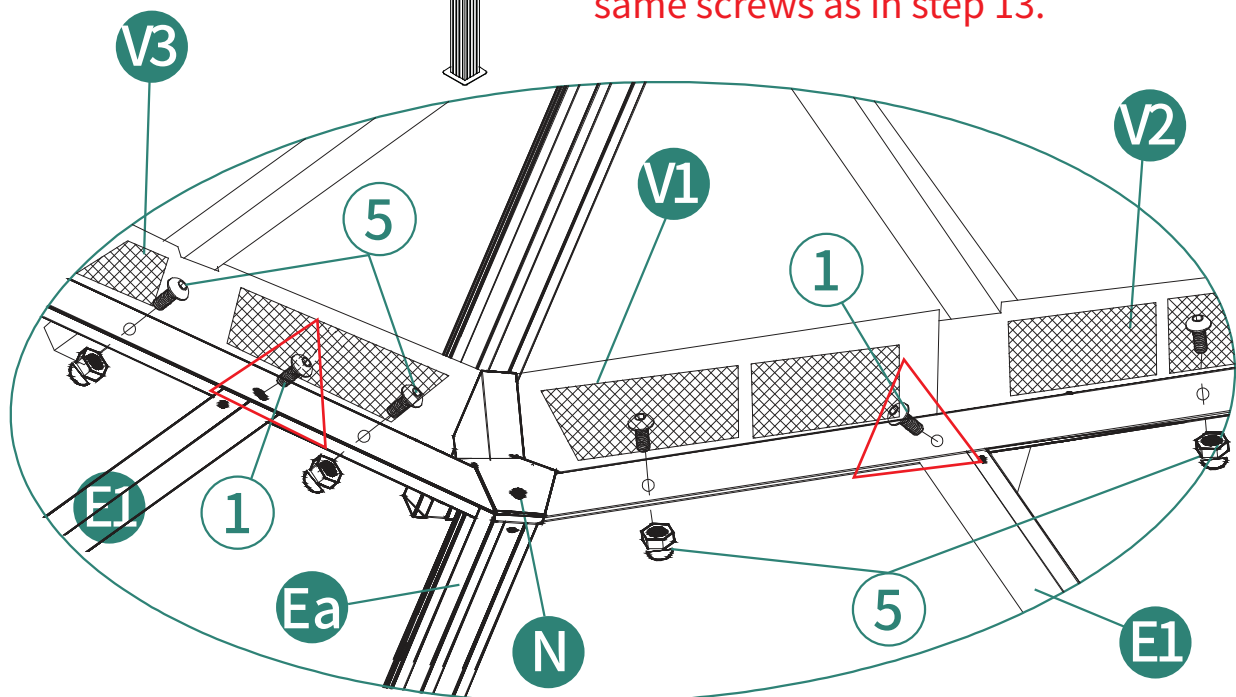

It's view from the bottom inside gazebo.

20

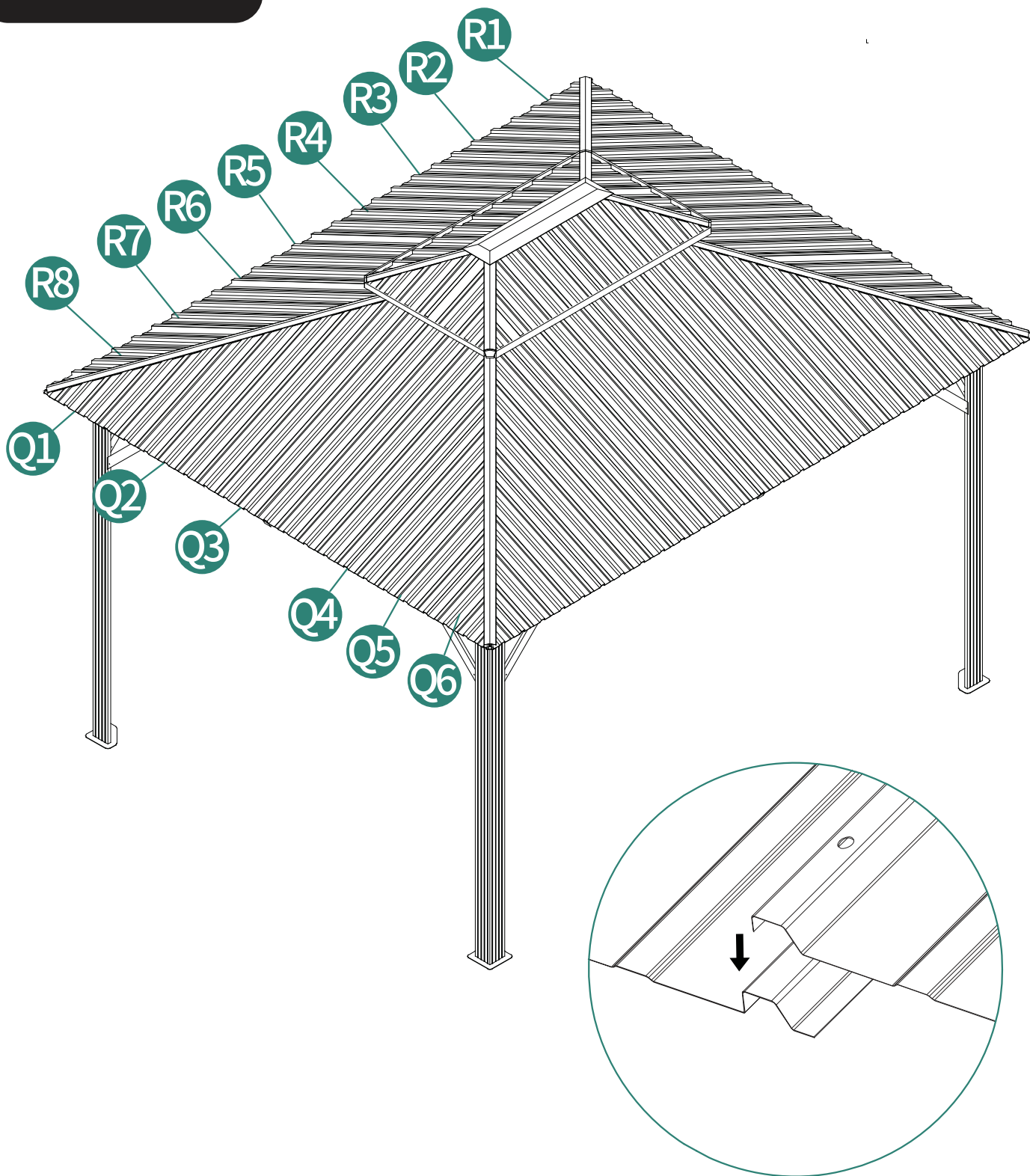

21

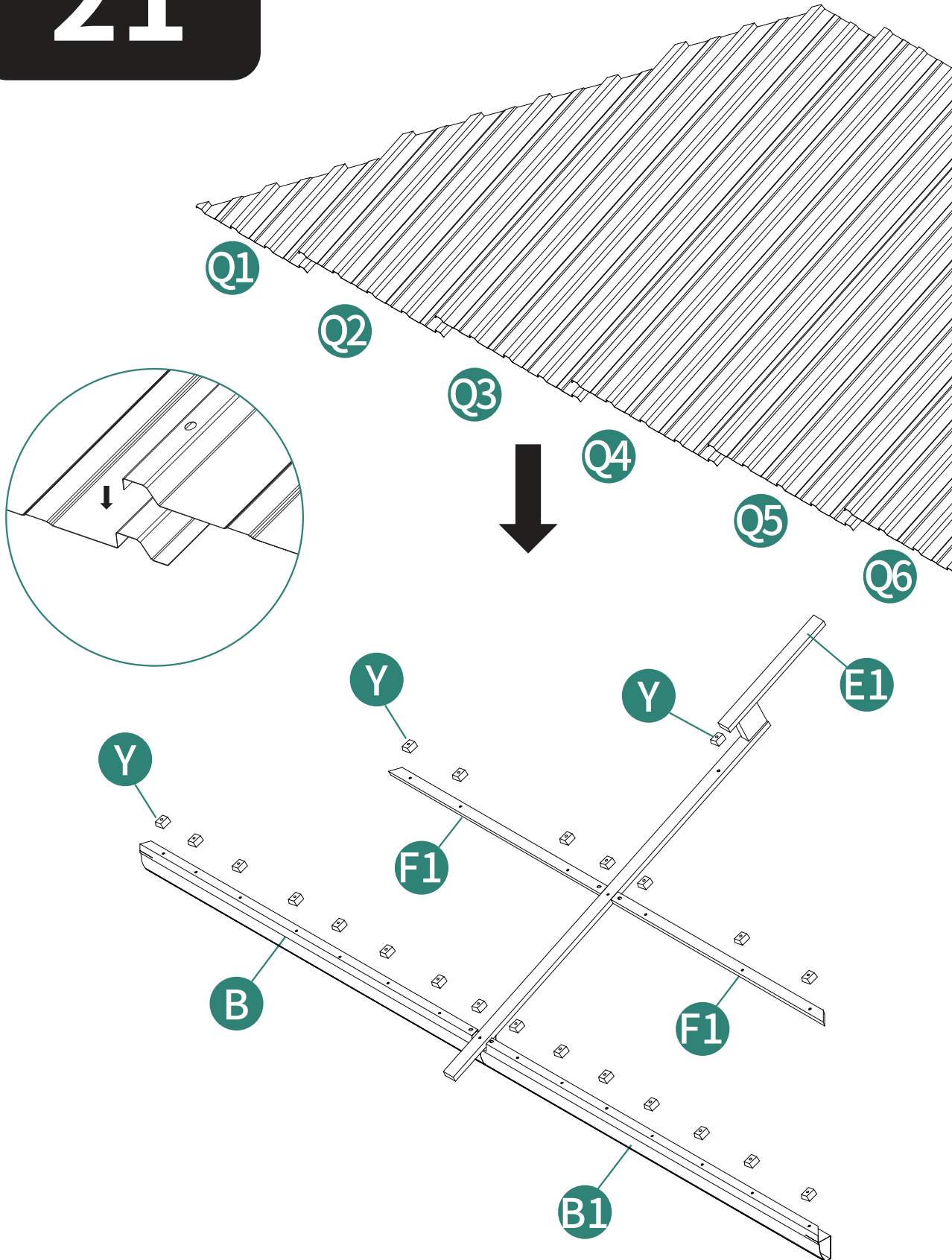

22

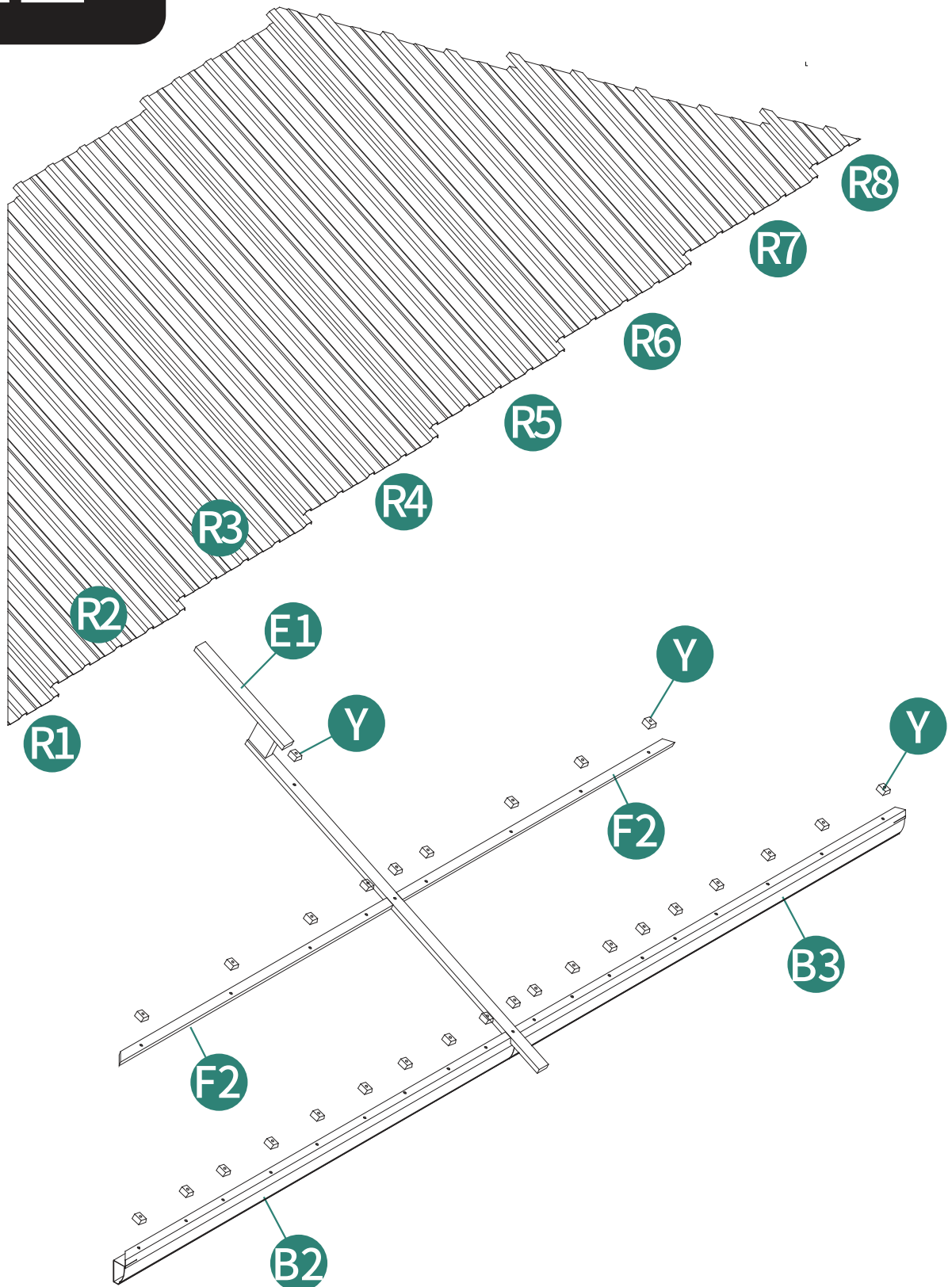

ASSEMBLY INSTRUCTIONS

23

- 
 (Y) 104 pcs
- 
 (2) 64 pcs
- 
 (3) 8 pcs
- 
 (6) 4 pcs
- 
 (7) 28 pcs

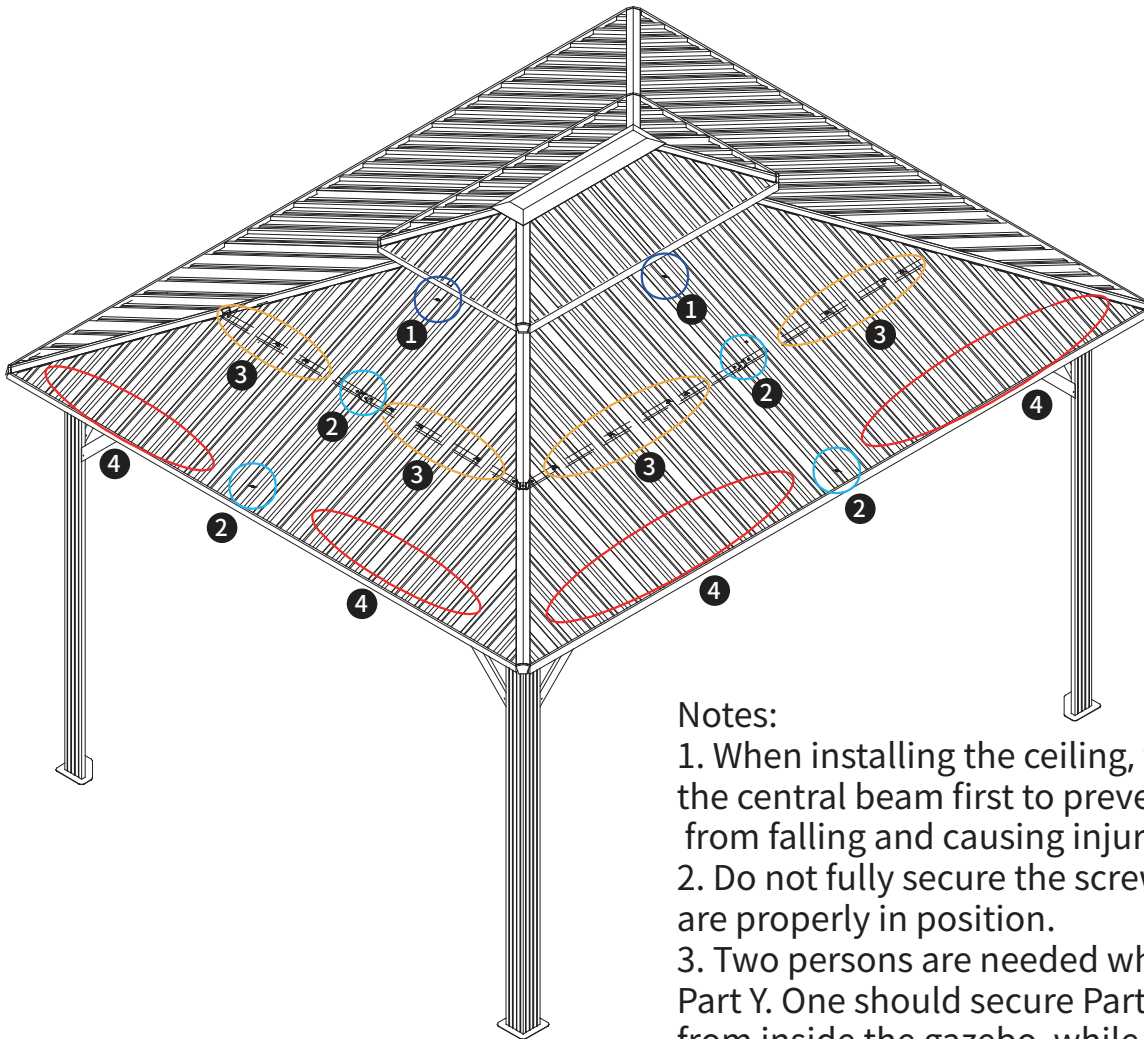

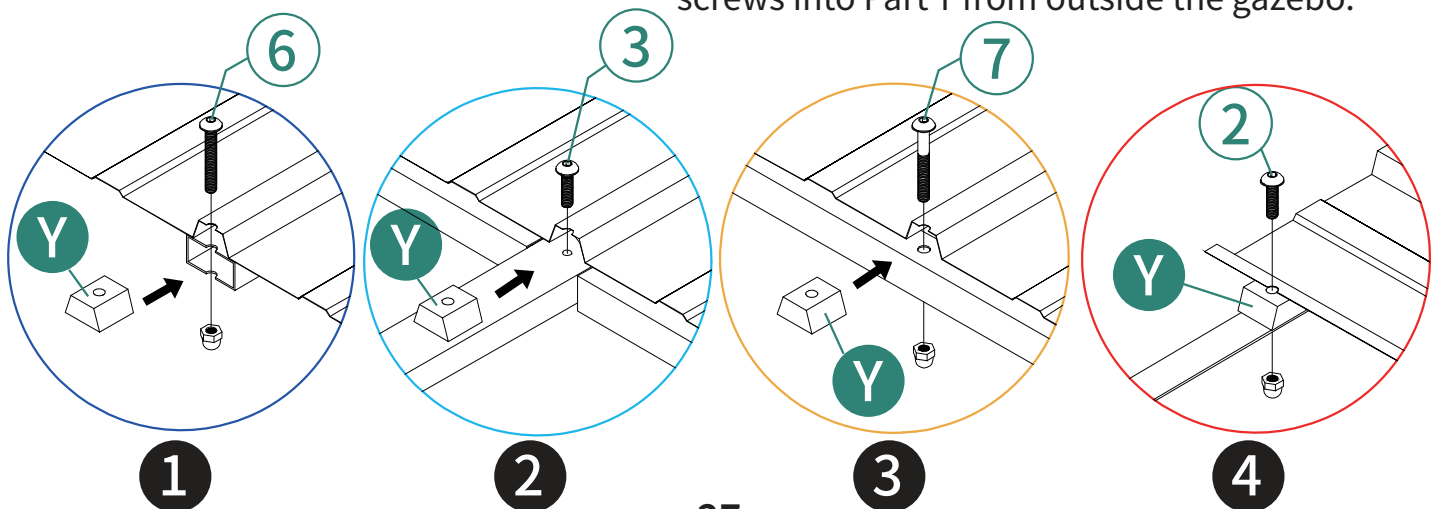

Notes:

1. When installing the ceiling, fix the screws on the central beam first to prevent the iron sheet from falling and causing injury.
2. Do not fully secure the screw until all screws are properly in position.
3. Two persons are needed when installing Part Y. One should secure Part Y's position from inside the gazebo, while the other inserts screws into Part Y from outside the gazebo.

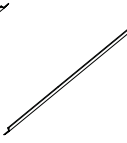
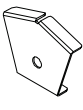

ASSEMBLY INSTRUCTIONS

24

-  **G5** 2pcs
-  **G6** 2pcs
-  **G7** 2pcs
-  **G8** 2pcs
-  **N** 4pcs
-  **N1** 4pcs
-  **1** 8pcs

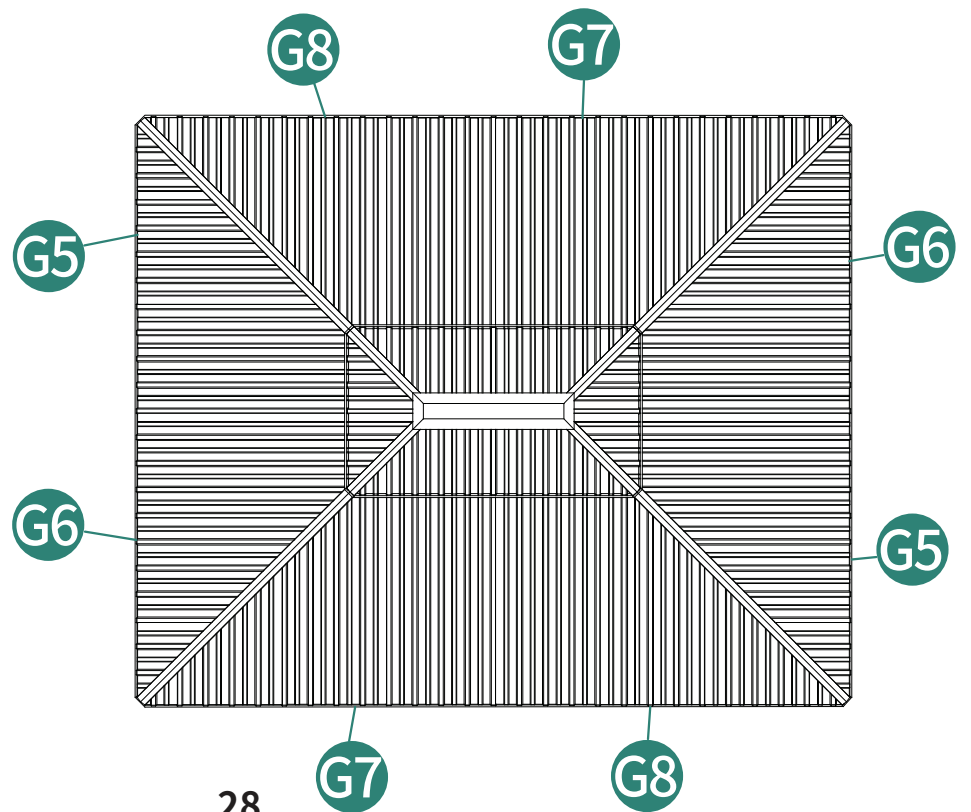
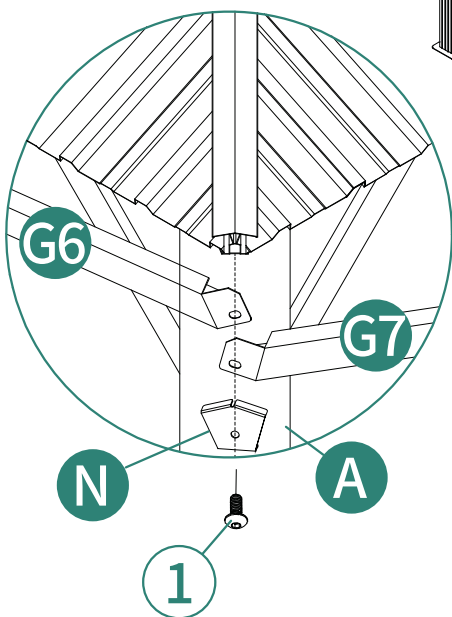
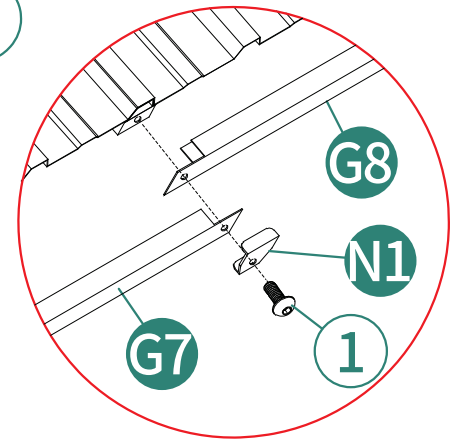
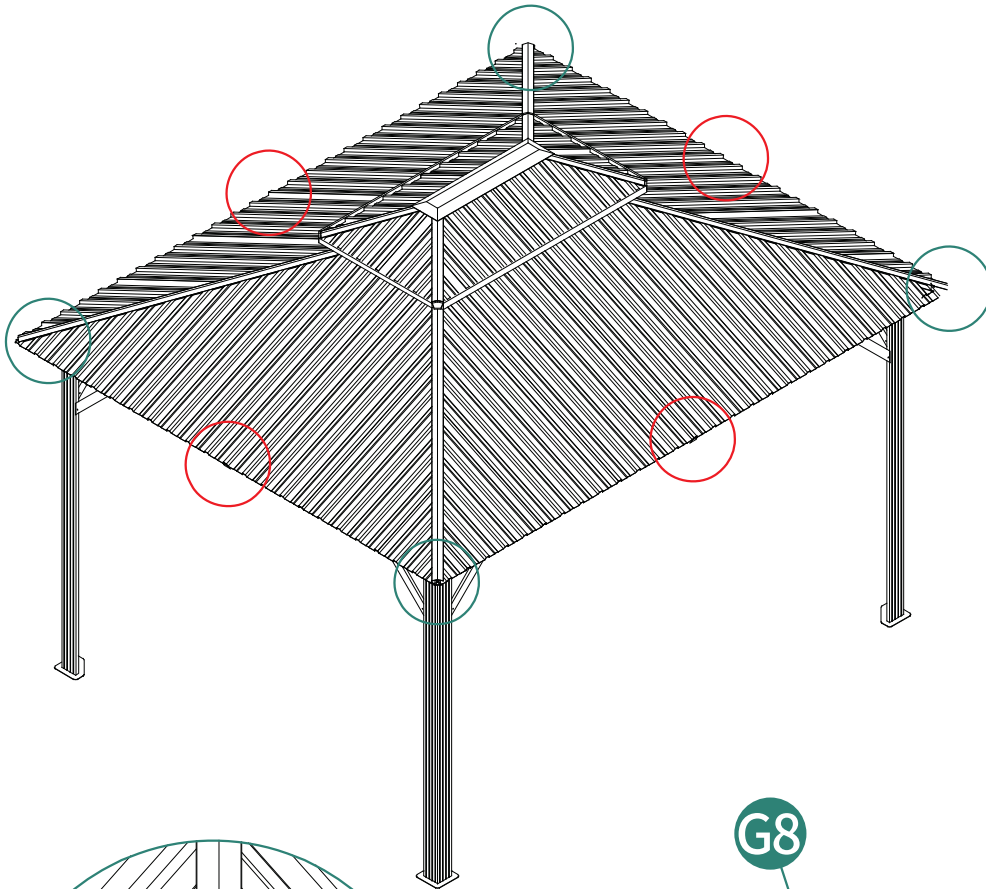

ASSEMBLY INSTRUCTIONS

25

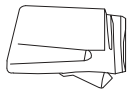

Ⓣ4pcs

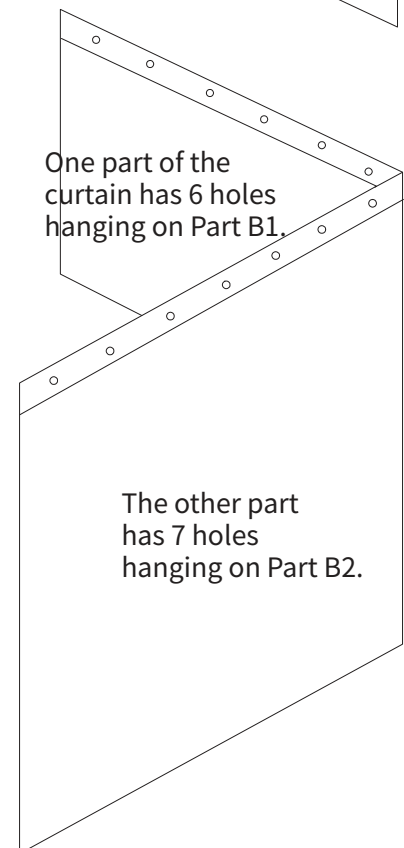
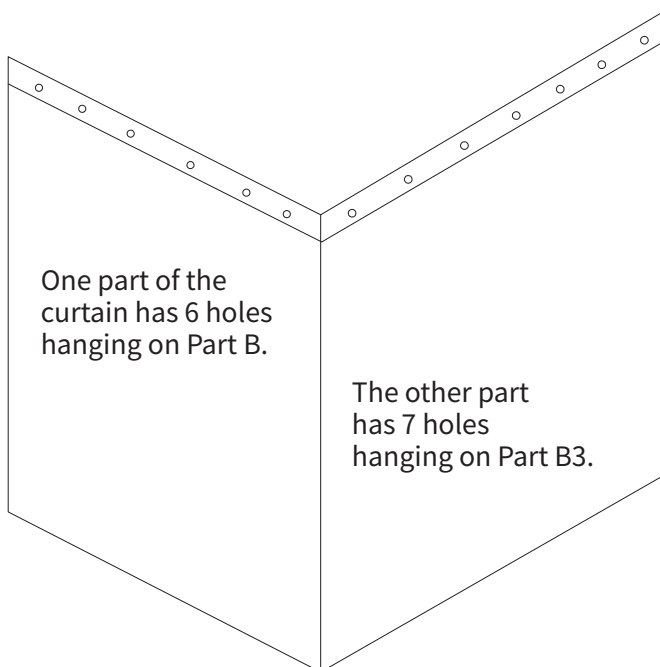
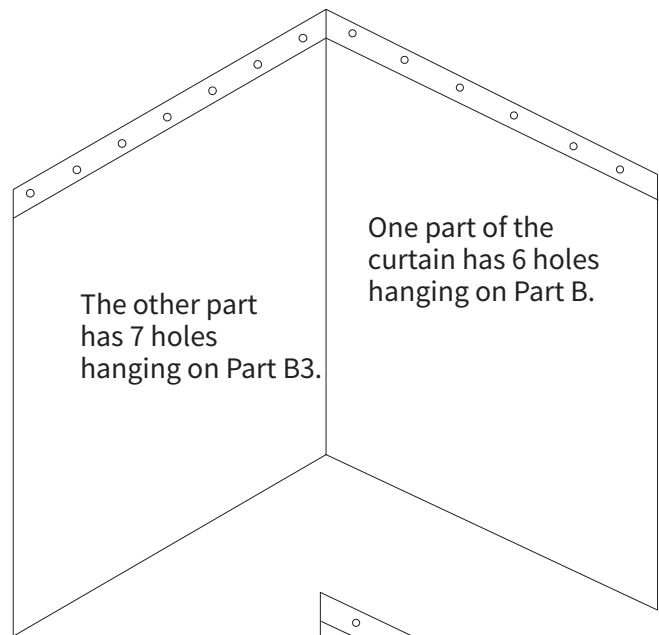
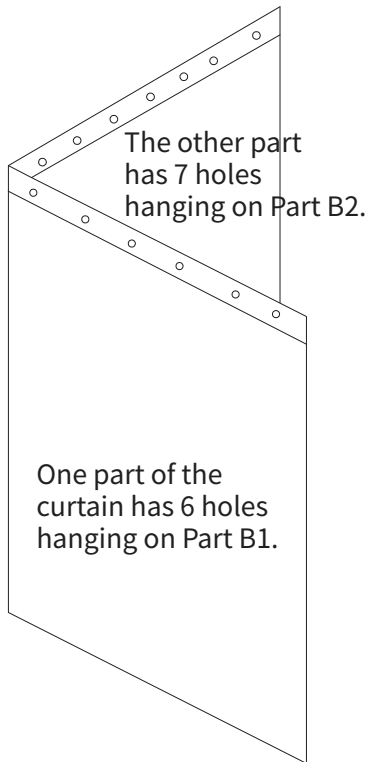

26

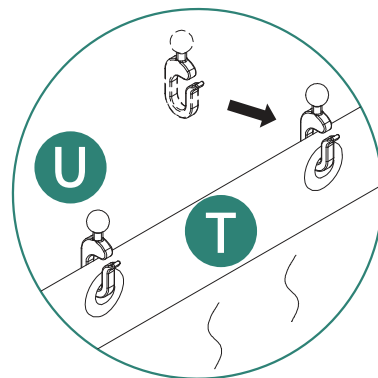
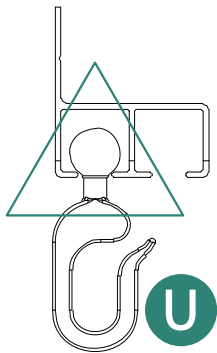
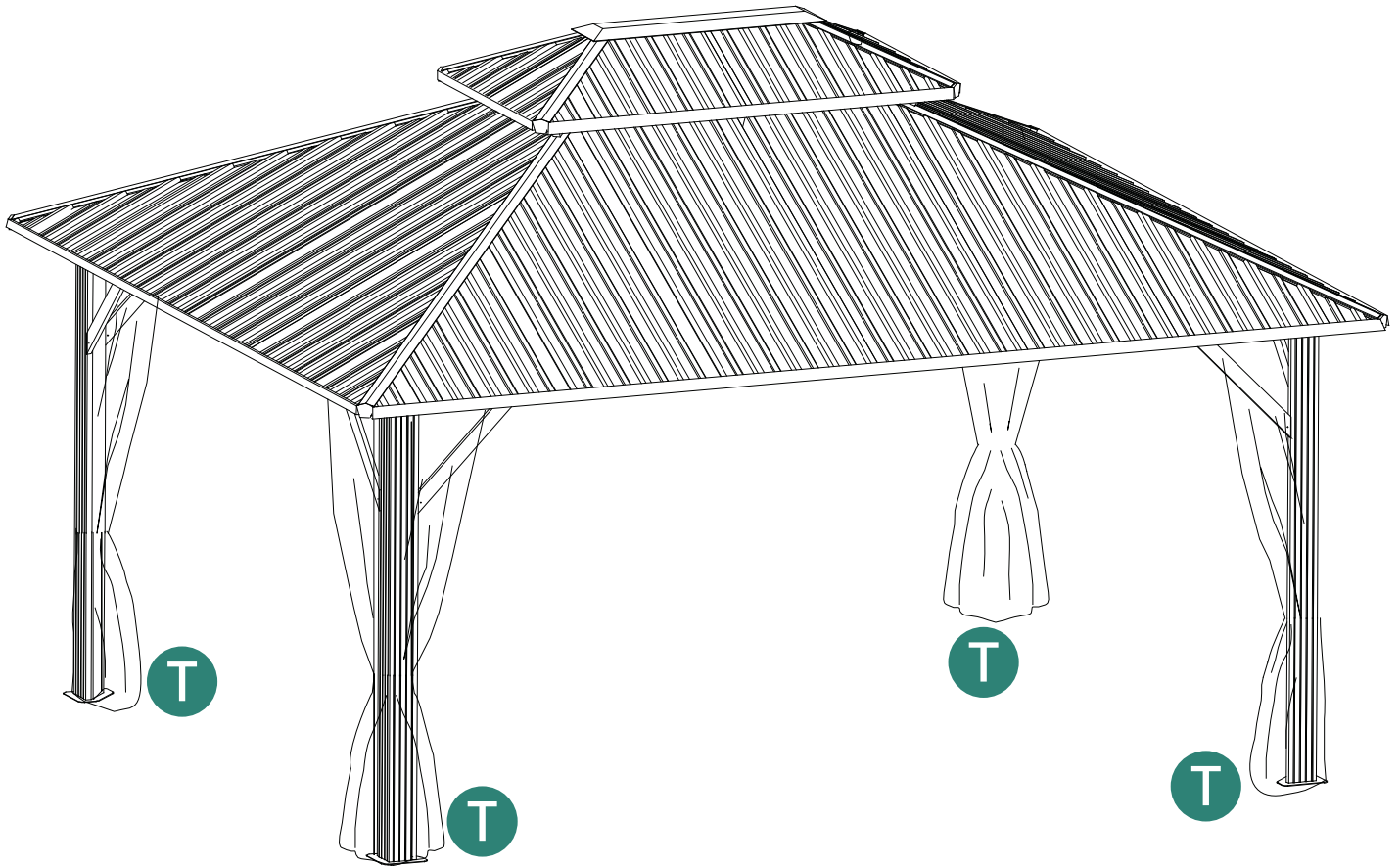

Pay attention to the sidewall curtain's installation position.

ASSEMBLY INSTRUCTIONS

27

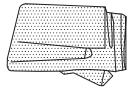

Ⓣ1 4pcs

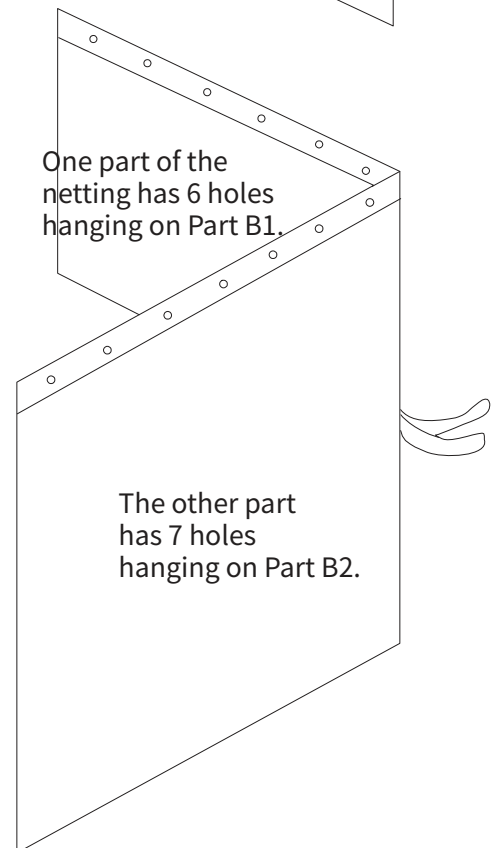
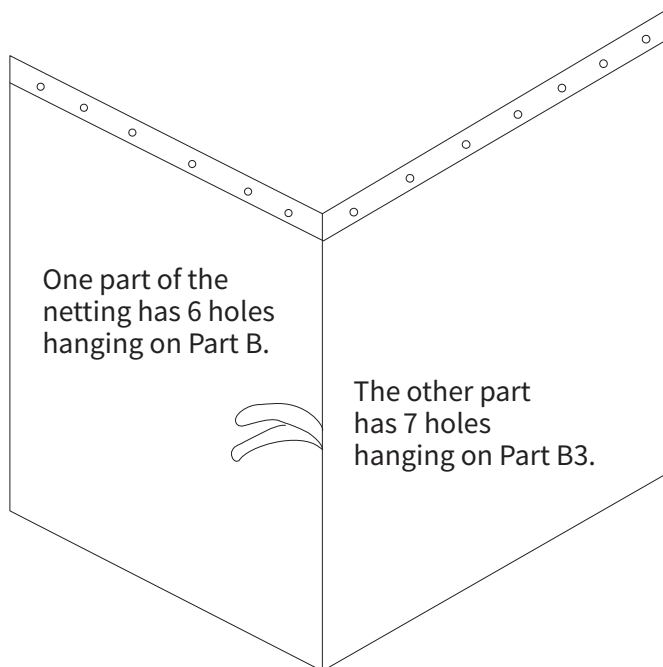
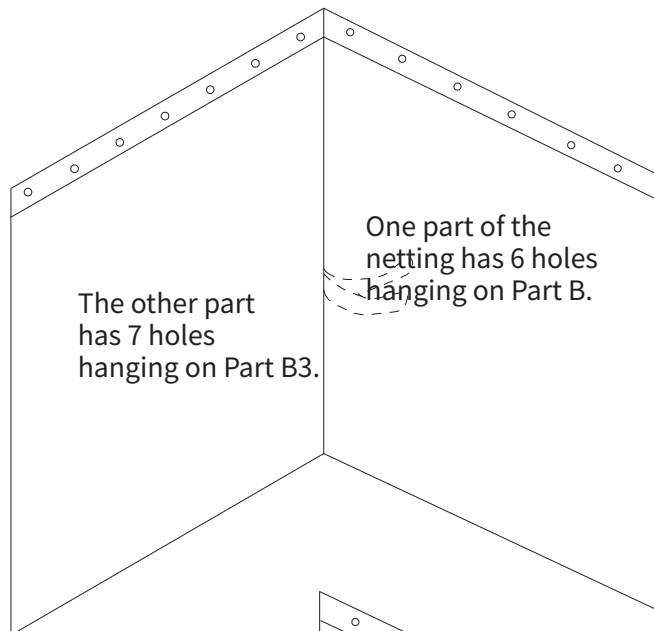
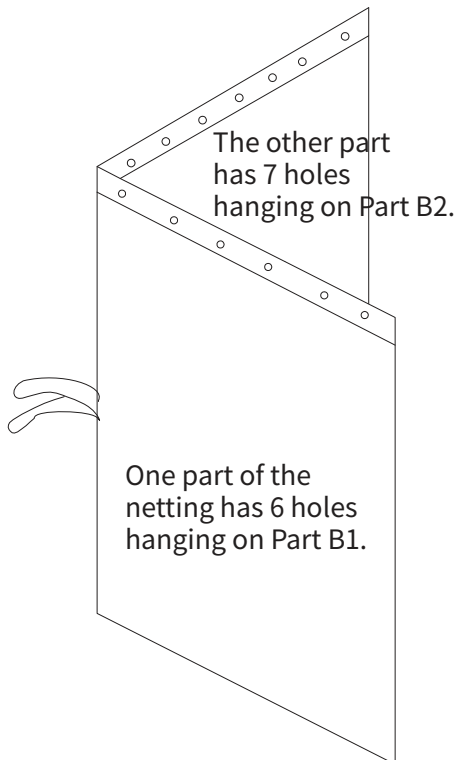

ASSEMBLY INSTRUCTIONS

28

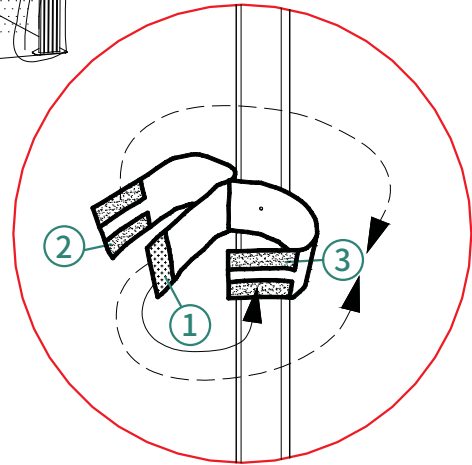
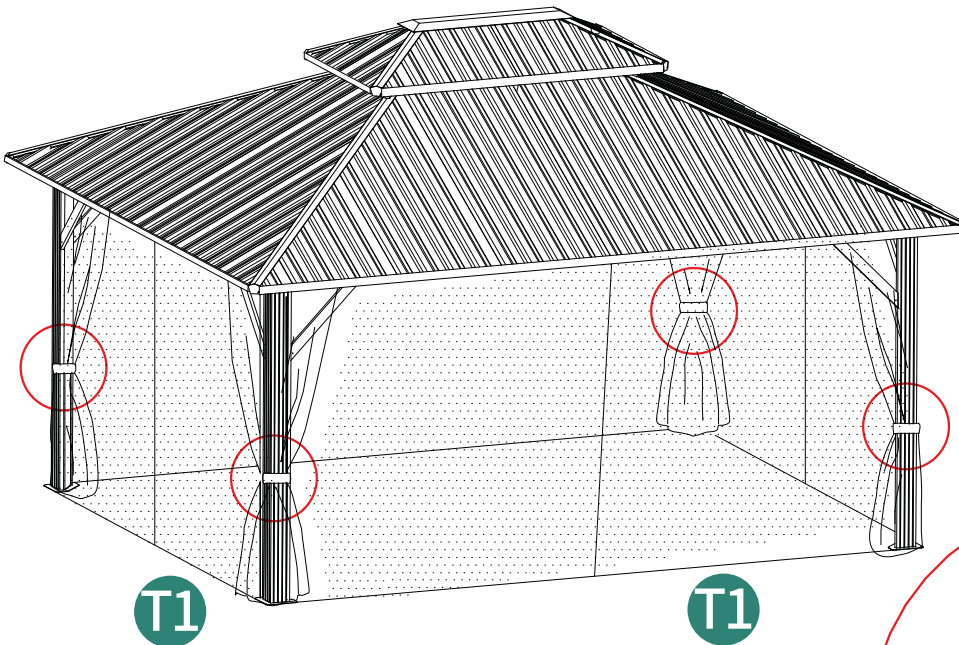

Note:
Attach 1 to 2 to secure parts T1 and T (curtains) together.
Attach 1 to 3 to secure the back curtain (T).
Attach 1 to 3 to secure the front netting (T1).

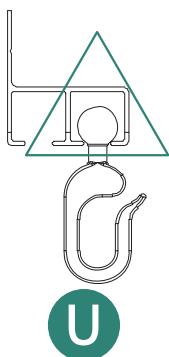

Pay attention to the sidewall netting's installation position.

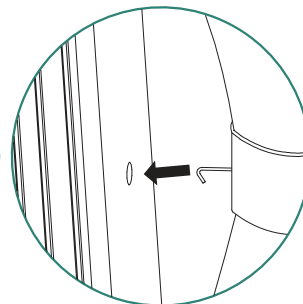
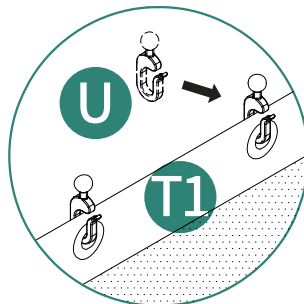

Hang the hook attached to the netting on Part A.

ASSEMBLY INSTRUCTIONS

29

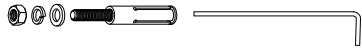

⑨12pcs ⑭12pcs

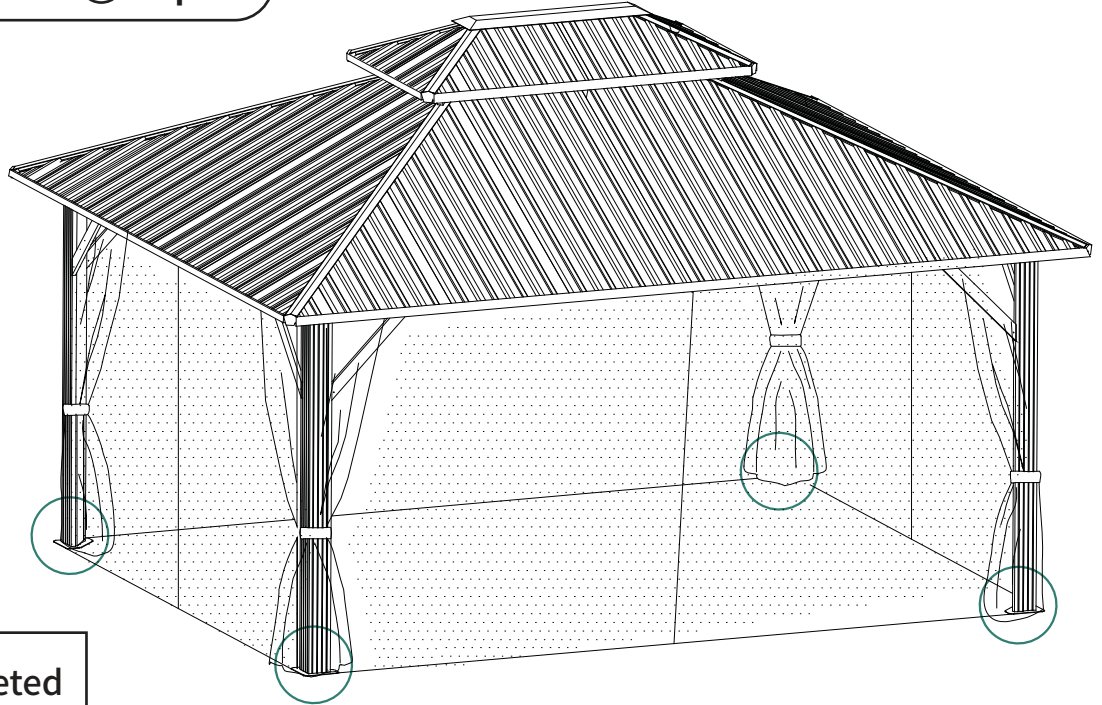

Installation Completed



To improve wind resistance, **be sure to complete this installation step. If expansion screws or ground nails are not installed, strong winds may topple the gazebo.**

Expansion screws are essential for stability on cement surfaces, and ground nails are for grassy surfaces. All are included in the accessories package.

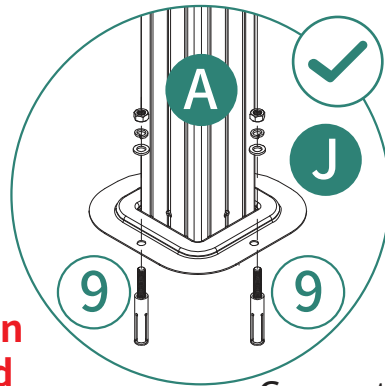

Cement surfaces

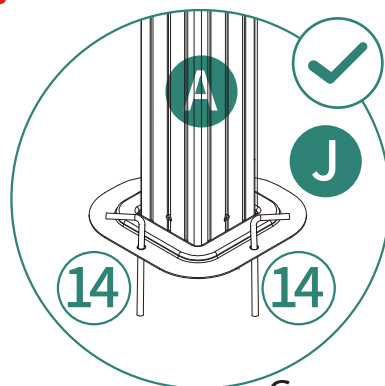
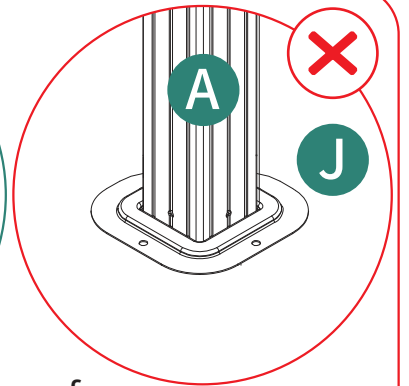

Grassy surfaces

