

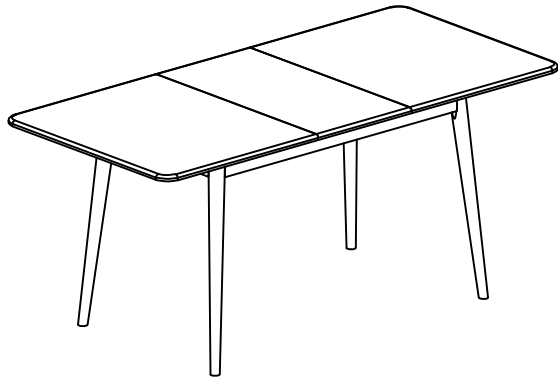

Installation & Assembly

Name: Dining Table 160CM





Caution: (Installed) in the parts table and hardware table means that it has been installed in the finished product, and is not in the hardware bag!!!



List of Parts

No.	Name	Graph	Size	Amount
1	Panel (installed)		1200*800*120MM	1
2	Foot column		743*φ55MM	4

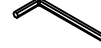
List of Hardware

No.	Name	Graph	Size	Amount
A	Hexagon socket head screw		M8*50MM	8
B	Flat shims		M8*14MM	8
C	spring-loaded shims		M8*13MM	8
D	Hexagon wrench		M5*57MM	1
E	Adjust the foot pads (installed)		M6*20MM	4
F	Lightweight semi-jointed telescopic rail (installed)		B2703-1 Stretch 400MM	2

This product has passed the wood inspection and paint inspection in full compliance with the national quality inspection standards. After passing the factory, it will be released from the factory and sold after confirming that the packaging is intact. For better service, please feel free to give us your opinions on after-sales service.

Name:	Wood Furniture
Qualification:	Pass
Grade:	Class 1

Standard

Required Workers



Inspector

QC 02



Step 1:

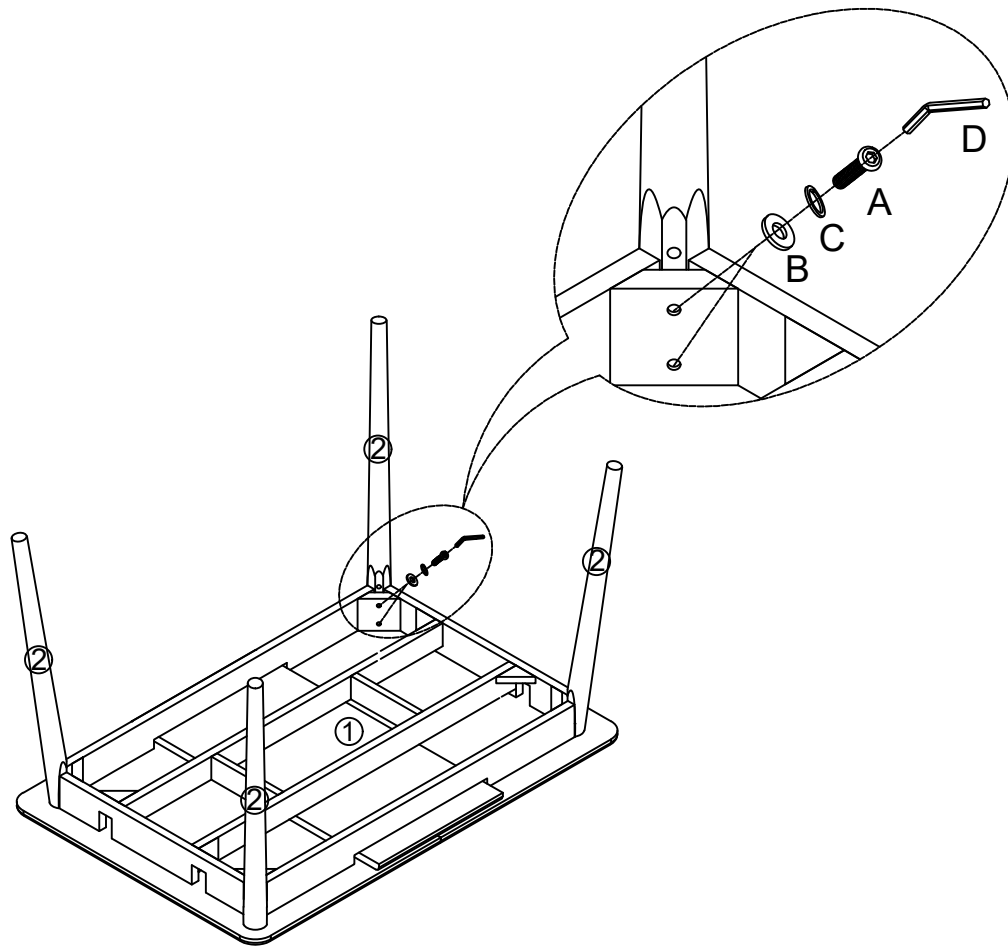

Caution: After unpacking, check the correct number of accessories against the instructions.

Assemble as shown. Align the holes in leg #2 with the holes in the corners of the frame and secure with hardware A, B, C, D.

Step 2:

Closed state

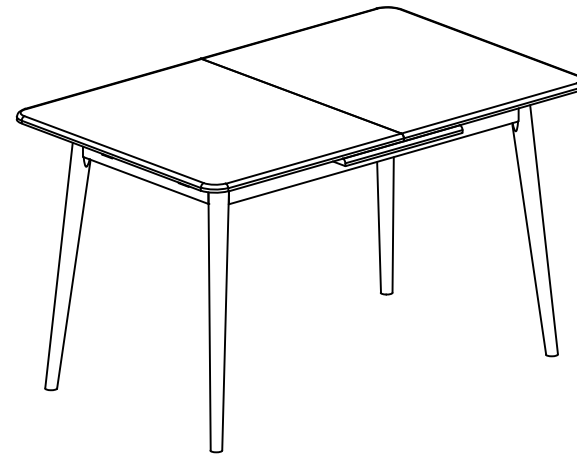

Open state

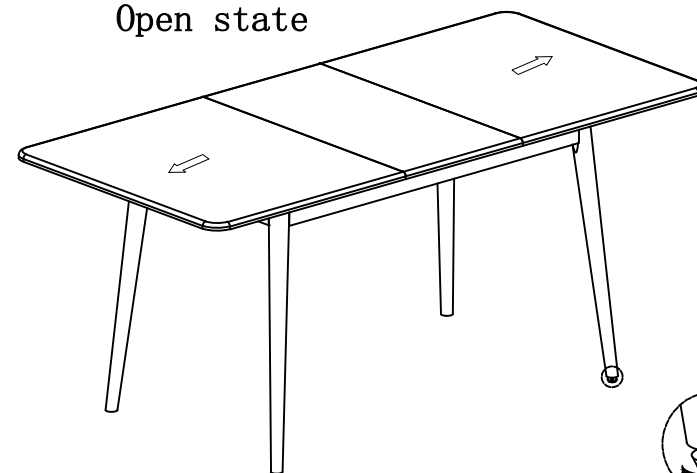

Adjust the foot pads

Assembly is complete, stretch the panel as needed.

Note 1: After opening the package, the switch wrench you receive is open, and you can directly extend or retract the panel as needed.

①



As shown in the picture:
the switch wrench is in
the closed state



②



As shown in the picture:
the switch wrench is in
the open state

Note 2: If the table legs are not stable, you can adjust the foot pads to keep the balance.

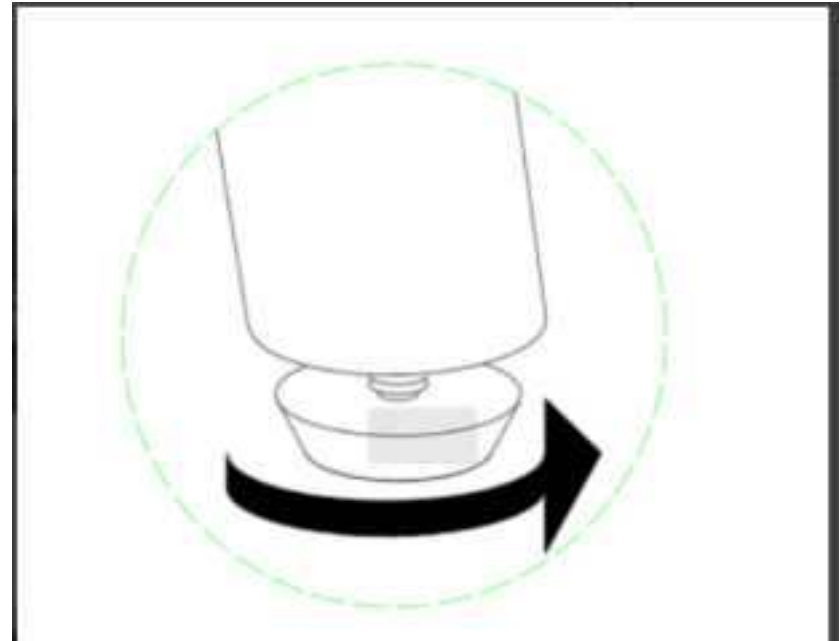

Adjust the foot pads