

Owner's Manual & Safety Instructions

Save This Manual Keep this manual for the safety warnings and precautions, assembly, operating, inspection, maintenance and cleaning procedures. Write the product's serial number in the back of the manual near the assembly diagram (or month and year of purchase if product has no number). Keep this manual and the receipt in a safe and dry place for future reference.

20j

COVERPRO™ 10 FT. x 17 FT.

PORTABLE GARAGE

Patent No.: US20120234418 A1; D409310; 7296584



Visit our website at: <http://www.harborfreight.com>
Email our technical support at: productsupport@harborfreight.com

62860

When unpacking, make sure that the product is intact and undamaged. If any parts are missing or broken, please call 1-888-866-5797 as soon as possible.

Copyright© 2015 by Harbor Freight Tools®. All rights reserved.
No portion of this manual or any artwork contained herein may be reproduced in any shape or form without the express written consent of Harbor Freight Tools. Diagrams within this manual may not be drawn proportionally. Due to continuing improvements, actual product may differ slightly from the product described herein.
Tools required for assembly and service may not be included.

⚠ WARNING

Read this material before using this product.
Failure to do so can result in serious injury.
SAVE THIS MANUAL.

Table of Contents

Safety	3	Maintenance	10
Specifications	4	Parts List.....	11
Assembly	4	Warranty	12



SAFETY

ASSEMBLY

MAINTENANCE

WARNING SYMBOLS AND DEFINITIONS

	This is the safety alert symbol. It is used to alert you to potential personal injury hazards. Obey all safety messages that follow this symbol to avoid possible injury or death.
	Indicates a hazardous situation which, if not avoided, will result in death or serious injury.
	Indicates a hazardous situation which, if not avoided, could result in death or serious injury.
	Indicates a hazardous situation which, if not avoided, could result in minor or moderate injury.
	Addresses practices not related to personal injury.

	WARNING marking concerning Risk of Eye Injury. Wear ANSI-approved safety goggles with side shields.		WARNING marking concerning Risk of Head Injury. Wear hard hat during assembly and service.
	Read the manual before assembly and/or use.		WARNING marking concerning Risk of Hand Injury. Wear heavy-duty work gloves during assembly and service.

IMPORTANT SAFETY INFORMATION

WARNING

Read all safety warnings and instructions.

Failure to follow the warnings and instructions may result in serious injury.

Save all warnings and instructions for future reference.

The warnings, precautions, and instructions discussed in this instruction manual cannot cover all possible conditions and situations that may occur. It must be understood by the operator that common sense and caution are factors which cannot be built into this product, but must be supplied by the operator.

Assembly Precautions

1. Do not assemble in windy conditions.
2. Assemble and install only on flat, level, hard surface.
3. Assemble and anchor only according to these instructions. Improper assembly or inadequate anchoring can create hazards.
4. Check for utility lines, tree branches and other structures before assembling.
5. Verify that installation surface has no hidden utility lines before anchoring.
6. Wear ANSI-approved safety goggles, heavy-duty work gloves and hard hat during assembly and service.
7. Keep assembly area clean and well lit.
8. Keep bystanders out of the area during assembly.
9. Do not assemble when tired or when under the influence of drugs or medication.
10. Product capabilities apply to properly and completely assembled product only.

Use Precautions

1. **DO NOT USE IN HIGH WIND. Remove cover if harsh weather or heavy rain threatens.**
2. **For temporary use only. Do not use for long-term shelter.**
3. **Do not use as tent. Does not meet tent flammability standards. Do not use grill, heater, or ignition sources inside or near cover.**
4. **Do not allow snow, rainwater or debris to accumulate or pool on cover.**
5. **Do not hang objects from any part of the Garage.**
6. This product is not a toy. Do not allow children to play with or near this item.
7. Use as intended only.
8. Inspect regularly, tighten all loose hardware and loose ropes, and secure all loosened anchors. If any parts are damaged, bent, or stretched, they must be replaced. Hardware may loosen during normal operation stresses. Loose hardware or damaged/altered parts will compromise the structural integrity of this product.
9. Maintain product labels and nameplates. These carry important safety information. If unreadable or missing, contact Harbor Freight Tools for a replacement.



SAVE THESE INSTRUCTIONS.

Specifications

Overall Dimensions	10' W x 17' L
Center Height	8'

Side Height	6' 3"
Pole Diameter	1.34"

Assembly Instructions



Read the **ENTIRE IMPORTANT SAFETY INFORMATION** section at the beginning of this manual including all text under subheadings therein before set up or use of this product.

WARNING

TO PREVENT SERIOUS INJURY:

Do not leave this product partially assembled. Assemble this product completely at one time.

Note: At least 3 workers are required for assembly. Before starting assembly, review the instructions and make sure there is enough time and the proper tools available to properly assemble.

Finger tighten all connections until assembly is done. Assemble on a flat, level surface.

Frame Assembly

1. Construct two End Assemblies using 3-Way Connectors (11), Rafter (3), Roof Corners (10), Stabilizers (16), Corner Legs (2), Corner Feet (9), Bolts (17, 18, 19) and Nuts (20).

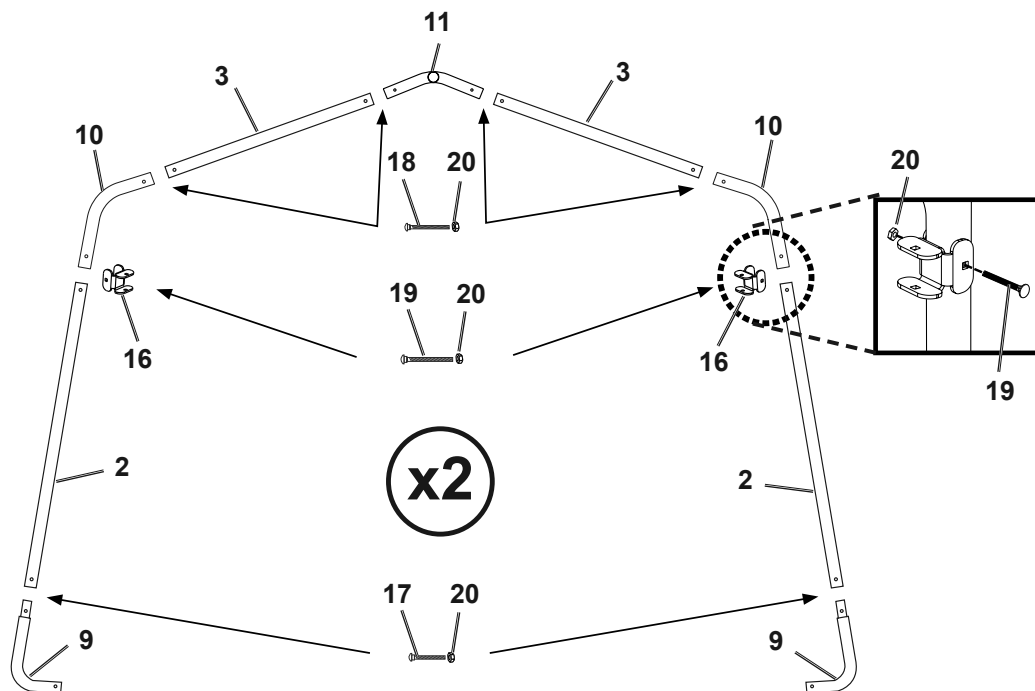

Figure A: End Assembly

- Construct two Middle Assemblies 4-Way Connectors (12), Rafters (3), Roof Corners (10), Stabilizers (16), Middle Legs (1), Middle Feet (8), Bolts (17, 18, 19) and Nuts (20).

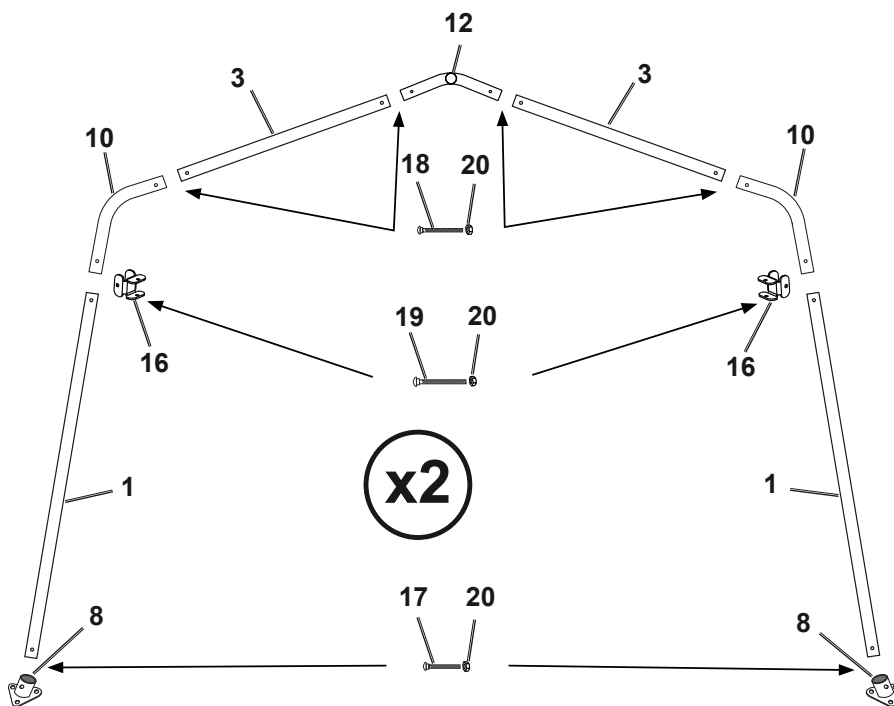

Figure B: Middle Assembly

- Attach a Ridge Rail (6) and two Top Rails (4) to one End Assembly with Bolts (18) and Nuts (20).
- Attach another Middle Assembly, a Ridge Rail (6) and two Swaged Top Rails (7) to the previous section with Bolts (18) and Nuts (20).
- Attach a Middle Assembly, a Ridge Rail (6) and two Swaged Top Rails (7) to the previous section with Bolts (18) and Nuts (20).
- Attach the other End Assembly to the previous section with Bolts (18) and Nuts (20).

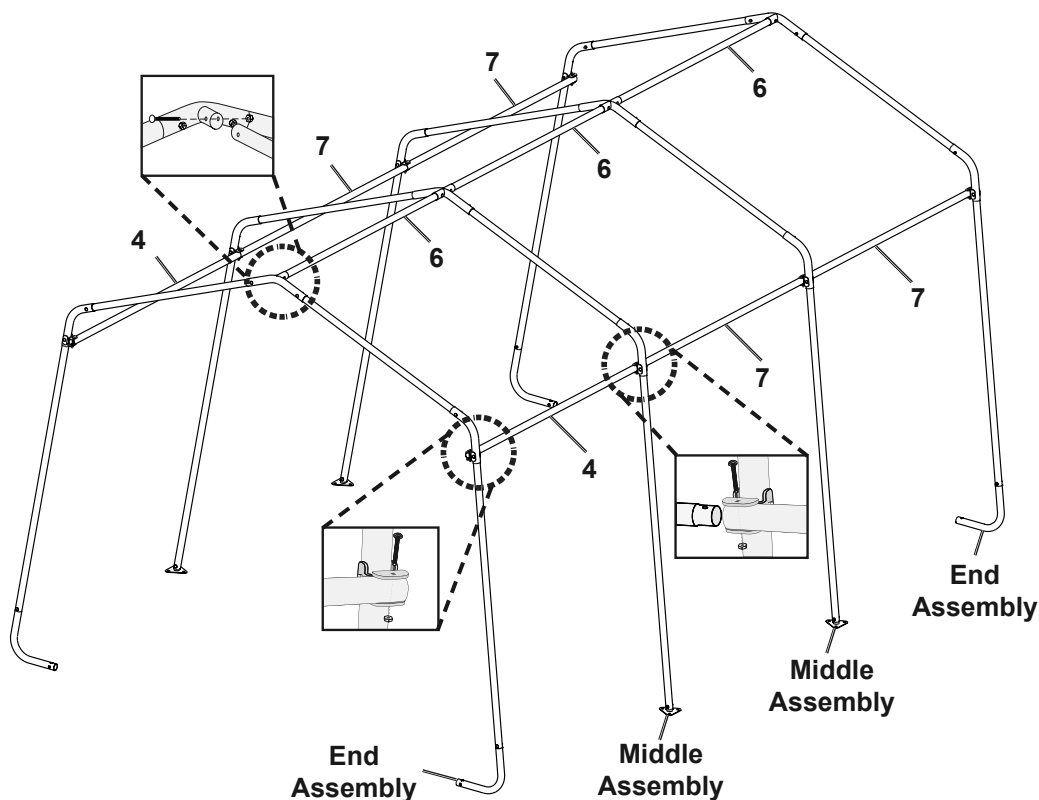

Figure C: Frame Assembly

Anchor the Frame

- WARNING! TO PREVENT SERIOUS INJURY: Verify that installation surface has no hidden utility lines before installing anchors. Install only on flat, level, hard surface.**
- Position the frame in the desired location.
- Level the frame end-to-end and side-to-side:
 - Measure the width of the frame at front and back. They both should measure 10'.
 - The distance diagonally in one direction (A) should be equal to the distance diagonally in the other direction (B).
 - If the measurements do not match, adjust the frame and measure again until they are equal.

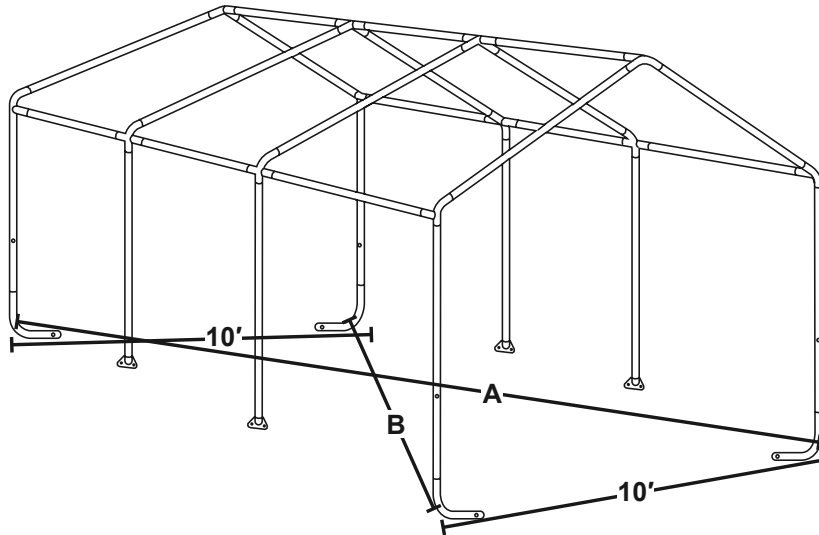

Figure D

- Once the frame is positioned, leveled, and squared, anchor the Corners:

WARNING! Anchor only according to these instructions. Improper assembly or inadequate anchoring can create hazards.

CAUTION! To prevent tripping hazard, position Anchors toward the interior of the frame, close to the Corner Feet.

- Use a metal bar (sold separately) to thread the Anchor (21) into the ground, until the loop at the top of the Anchor extends just above the ground.

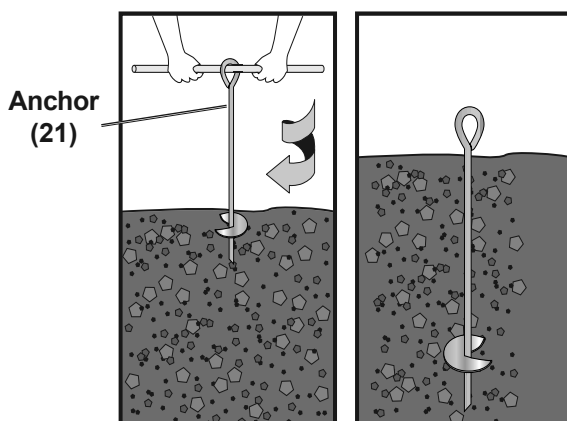

Figure E

- Insert a Wire Rope (22) through the Anchor and Corner Foot.
- Tighten the Wire Rope and secure it using a Wire Rope Clamp (23). Tighten the nuts evenly.
- Repeat on the other corners.

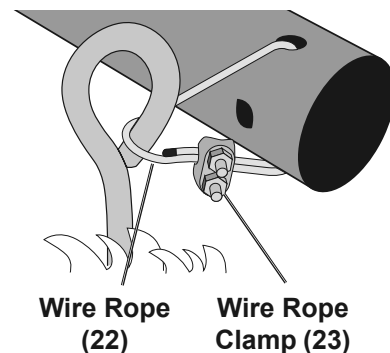

Figure F

Note: Middle Feet can be anchored to increase stability.

Attach Front and Back Covers

WARNING! TO PREVENT SERIOUS INJURY:

When installing Door and Back cover, ensure that pre-installed straps are not pulled out of the Hem.

1. Position the Front Cover (25) so that the zippers face outside and the warning label faces inside.

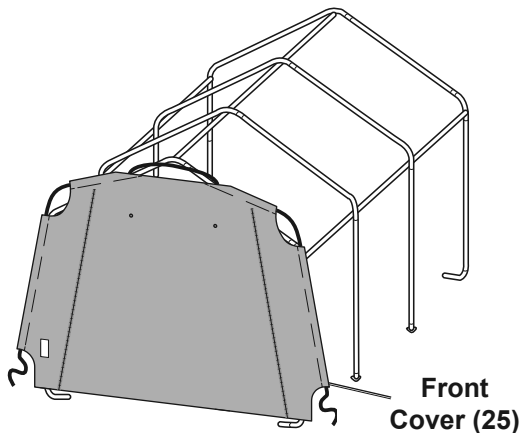

Figure G

2. From the inside, remove the Ridge Rail from the 3-Way Connector.
3. Place the strap over the 3-Way Ridge Connector, then reattach the Ridge Rail.
4. Tighten the strap, by pulling on the ends, so that the flaps wrap around the frame.

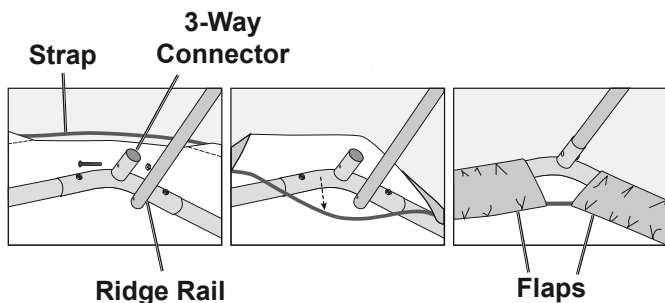

Figure H

5. Remove the Top Rail from the Stabilizer on the left side.
6. Place the strap over the Stabilizer, then reattach the Top Rail.
7. Tighten the strap, by pulling on these ends, so that the flaps wrap around the frame.
8. Repeat steps above on the right side.

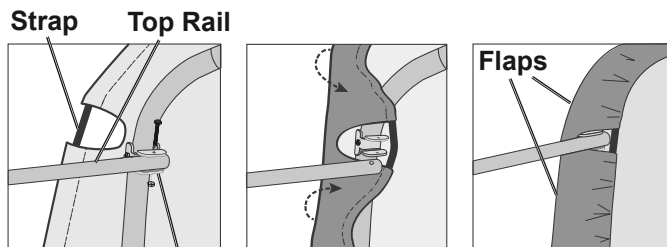

Figure I

9. Attach the Back Cover (26) in the same manner.
10. From the inside, secure Front and Back Covers to the Corner Legs with Ratchets (27):
 - a. Insert the Ratchet's S-Hook through the hole on the side of the Corner Leg.
 - b. Thread the strap through the Ratchet spindle, then pull up on the strap.
 - c. Raise and lower the Ratchet handle to tighten the strap.
 - d. Repeat for the other corners.

Note: To avoid damaging the straps, do not overtighten the Ratchets.

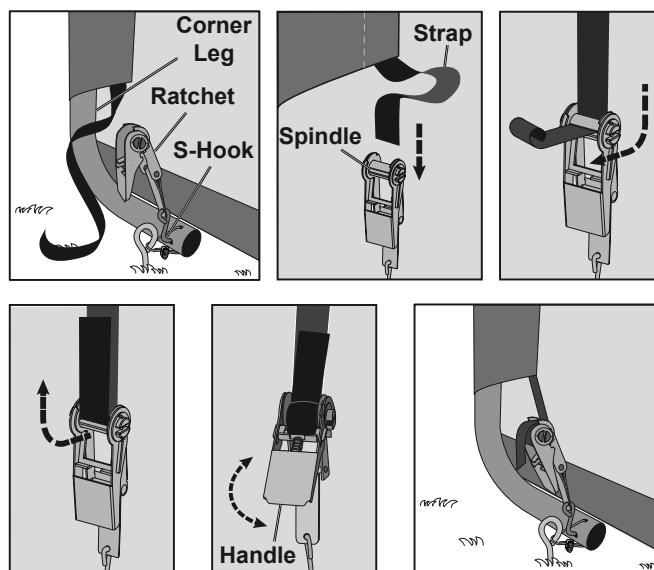

Figure J

Attach Top Cover

1. Lay the Top Cover (24) on the ground, next to the frame, so that the inside pocket for the opposite side is facing up.
2. Slide two Bottom Rails (5) into the middle openings of the pocket.
3. Tie a rope (sold separately) to each Bottom Rail.

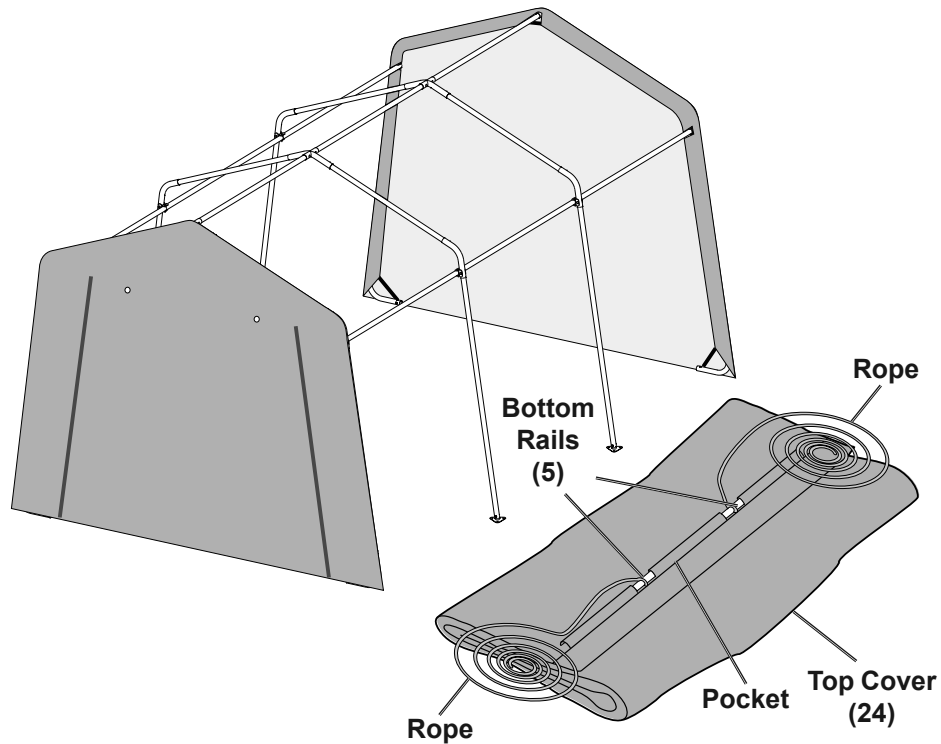

Figure K

4. Throw the ropes over the top of the frame to the other side.
5. From the other side, pull the ropes to properly position the Top Cover.
6. Remove the ropes and Bottom Rails.
7. Secure all four Top Cover corners to the outside of the Corner Legs with Ratchets. (See Figure J.)

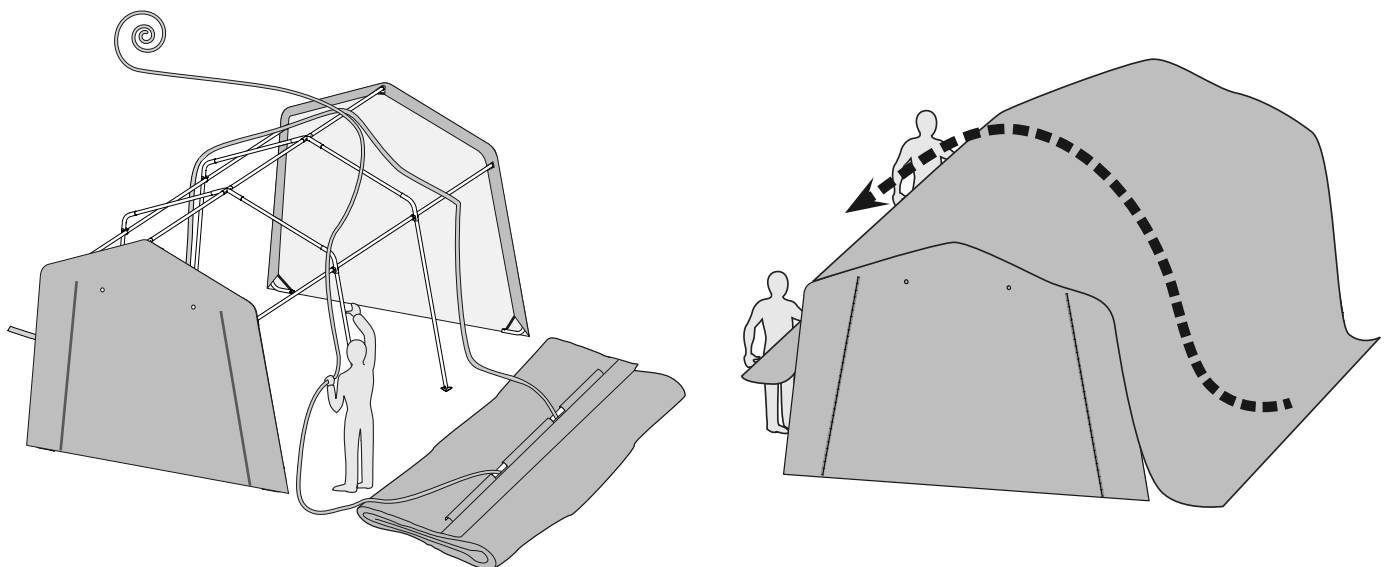

Figure L

8. Unzip and roll up the Front Cover.
9. Install Bungee Cords (15) to secure the Front Cover.

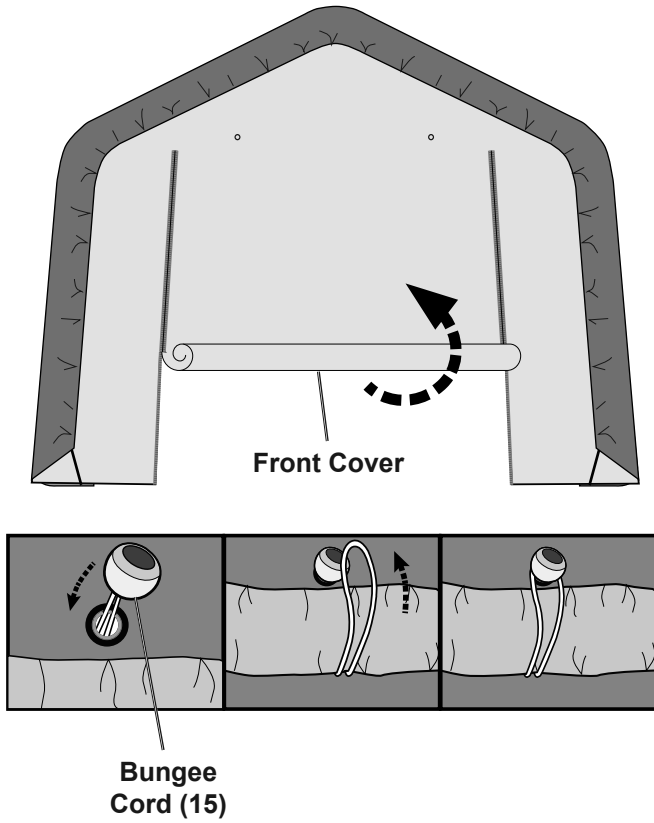

Figure M

10. From the inside, slide one Bottom Rail into each segment of the pocket, between the legs.
11. On the corners, secure Bottom Rails to Corner Legs with Corner Clamps (14), Bolts (17) and Nuts (20).
12. In the middle, secure Bottom Rails to Middle Legs with Middle Clamps (13), Bolts (17) and Nuts (20).

Note: To prevent tearing fabric, position all Bolts so that the bolt heads are against the fabric.

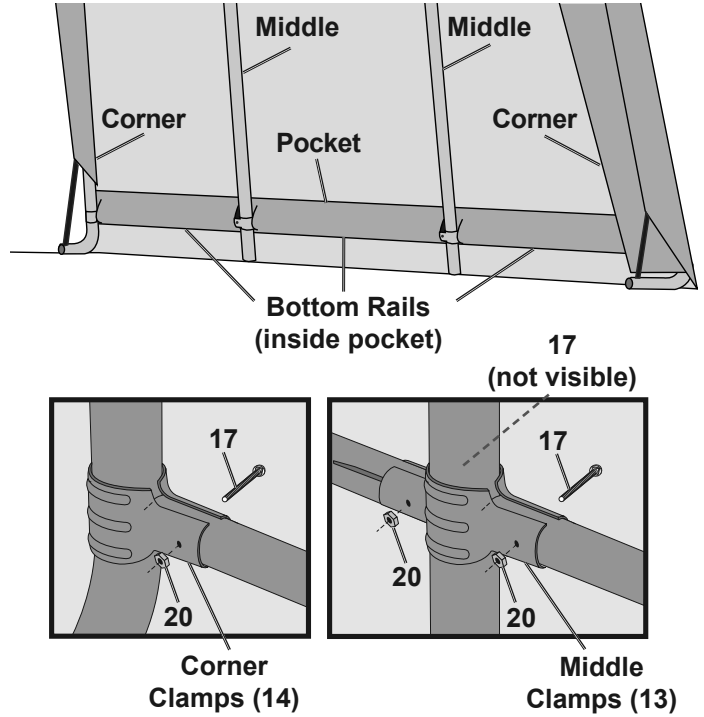

Figure N

13. Now that assembly is done, tighten all connections with a wrench (sold separately). Make sure all connections are properly tightened before use. Do not overtighten.



Maintenance



Procedures not specifically explained in this manual must be performed only by a qualified technician.

WARNING

TO PREVENT SERIOUS INJURY FROM PRODUCT FAILURE:

Do not use damaged products. If damage is noted, have the problem corrected before further use.

Inspection

MONTHLY, inspect the general condition of the Portable Garage. Check for:

- loose ratchet tie downs, anchors, tube connections, and rail clamps (tighten as needed),
- torn or frayed covers, ropes, or wire ropes,
- cracked, bent, or broken parts, and
- any other condition that may affect its safe operation.

Cleaning

1. Immediately remove any accumulated debris from the cover with a broom, mop, or other soft-sided instrument from the outside. **DO NOT** use sharp instruments.
2. **PERIODICALLY**, clean cover with mild soap and water. **DO NOT** use bleach or harsh abrasive products.

PLEASE READ THE FOLLOWING CAREFULLY

THE MANUFACTURER AND/OR DISTRIBUTOR HAS PROVIDED THE PARTS LIST IN THIS MANUAL AS A REFERENCE TOOL ONLY. NEITHER THE MANUFACTURER OR DISTRIBUTOR MAKES ANY REPRESENTATION OR WARRANTY OF ANY KIND TO THE BUYER THAT HE OR SHE IS QUALIFIED TO MAKE ANY REPAIRS TO THE PRODUCT, OR THAT HE OR SHE IS QUALIFIED TO REPLACE ANY PARTS OF THE PRODUCT. IN FACT, THE MANUFACTURER AND/OR DISTRIBUTOR EXPRESSLY STATES THAT ALL REPAIRS AND PARTS REPLACEMENTS SHOULD BE UNDERTAKEN BY CERTIFIED AND LICENSED TECHNICIANS, AND NOT BY THE BUYER. THE BUYER ASSUMES ALL RISK AND LIABILITY ARISING OUT OF HIS OR HER REPAIRS TO THE ORIGINAL PRODUCT OR REPLACEMENT PARTS THERETO, OR ARISING OUT OF HIS OR HER INSTALLATION OF REPLACEMENT PARTS THERETO.











Record Product's Serial Number Here: _____







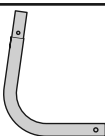
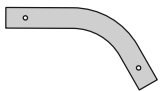
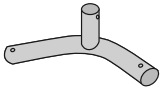
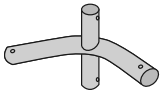





Note: If product has no serial number, record month and year of purchase instead.

Note: Some parts are listed and shown for illustration purposes only, and are not available individually as replacement parts. Specify UPC 193175336859 when ordering parts.

Parts List

Note: Individual part illustrations not to scale.

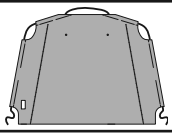
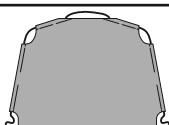
Part	Description	Illustration	Qty
1	Middle Leg 74"		4
2	Corner Leg 63-2/3"		4
3	Rafter 42-1/3"		8
4	Top Rail 68-1/2"		2
5	Bottom Rail 66"		6
6	Ridge Rail 65-13/32"		3
7	Swaged Top Rail 69-1/2"		4
8	Middle Foot		4
9	Corner Foot		4
10	Roof Corner		8
11	3-Way Connector		2
12	4-Way Connector		2
13	Middle Clamp		8
14	Corner Clamp		8

Part	Description	Illustration	Qty
15	Bungee Cord		2
16	Stabilizer		8
17	Bolt Ø1/4" x 1-5/8"		20
18	Bolt Ø1/4" x 1-7/8"		30
19	Bolt Ø1/4" x 2"		8
20	Nut Ø1/4"		58
21	Anchor 15"		4
22	Wire Rope		4
23	Wire Rope Clamp		4
24	Top Cover		1
25	Front Cover		1
26	Back Cover		1
27	Ratchet		8

Limited 90 Day Warranty

Harbor Freight Tools Co. makes every effort to assure that its products meet high quality and durability standards, and warrants to the original purchaser that this product is free from defects in materials and workmanship for the period of 90 days from the date of purchase. This warranty does not apply to damage due directly or indirectly, to misuse, abuse, negligence or accidents, repairs or alterations outside our facilities, criminal activity, improper installation, normal wear and tear, or to lack of maintenance. We shall in no event be liable for death, injuries to persons or property, or for incidental, contingent, special or consequential damages arising from the use of our product. Some states do not allow the exclusion or limitation of incidental or consequential damages, so the above limitation of exclusion may not apply to you. THIS WARRANTY IS EXPRESSLY IN LIEU OF ALL OTHER WARRANTIES, EXPRESS OR IMPLIED, INCLUDING THE WARRANTIES OF MERCHANTABILITY AND FITNESS.

To take advantage of this warranty, the product or part must be returned to us with transportation charges prepaid. Proof of purchase date and an explanation of the complaint must accompany the merchandise. If our inspection verifies the defect, we will either repair or replace the product at our election or we may elect to refund the purchase price if we cannot readily and quickly provide you with a replacement. We will return repaired products at our expense, but if we determine there is no defect, or that the defect resulted from causes not within the scope of our warranty, then you must bear the cost of returning the product.

This warranty gives you specific legal rights and you may also have other rights which vary from state to state.

