

# Owner's Manual & Safety Instructions

**Save This Manual** Keep this manual for the safety warnings and precautions, assembly, operating, inspection, maintenance and cleaning procedures. Write the product's serial number in the back of the manual near the assembly diagram (or month and year of purchase if product has no number). Keep this manual and the receipt in a safe and dry place for future reference.

22a

# WARRIOR™

## 18V LITHIUM 3/8" CORDLESS DRILL/DRIVER



Visit our website at: <http://www.harborfreight.com>  
Email our technical support at: [productsupport@harborfreight.com](mailto:productsupport@harborfreight.com)

58389

When unpacking, make sure that the product is intact and undamaged. If any parts are missing or broken, please call 1-888-866-5797 as soon as possible.

Copyright© 2021 by Harbor Freight Tools®. All rights reserved.  
No portion of this manual or any artwork contained herein may be reproduced in any shape or form without the express written consent of Harbor Freight Tools. Diagrams within this manual may not be drawn proportionally. Due to continuing improvements, actual product may differ slightly from the product described herein.  
Tools required for assembly and service may not be included.

### ⚠ WARNING

Read this material before using this product.  
Failure to do so can result in serious injury.  
**SAVE THIS MANUAL.**

# Table of Contents

Safety .....	2	Maintenance .....	10
Specifications .....	7	Parts List and Diagram .....	11
Setup .....	7	Warranty .....	12
Operation.....	8		

SAFETY



SETUP

## WARNING SYMBOLS AND DEFINITIONS

	This is the safety alert symbol. It is used to alert you to potential personal injury hazards. Obey all safety messages that follow this symbol to avoid possible injury or death.
	Indicates a hazardous situation which, if not avoided, will result in death or serious injury.
	Indicates a hazardous situation which, if not avoided, could result in death or serious injury.
	Indicates a hazardous situation which, if not avoided, could result in minor or moderate injury.
	Addresses practices not related to personal injury.

OPERATION

## IMPORTANT SAFETY INFORMATION

### General Power Tool Safety Warnings

#### WARNING

Read all safety warnings, instructions, illustrations and specifications provided with this power tool. Failure to follow all instructions listed below may result in electric shock, fire and/or serious injury.



Save all warnings and instructions for future reference.

The term "power tool" in the warnings refers to your mains-operated (corded) power tool or battery-operated (cordless) power tool.

- |   |   |
|---|---|
| <ol style="list-style-type: none"> <li>1. <b>Work area safety</b> <ol style="list-style-type: none"> <li>a. <b>Keep work area clean and well lit.</b><br/><i>Cluttered or dark areas invite accidents.</i></li> <li>b. <b>Do not operate power tools in explosive atmospheres, such as in the presence of flammable liquids, gases or dust.</b> <i>Power tools create sparks which may ignite the dust or fumes.</i></li> <li>c. <b>Keep children and bystanders away while operating a power tool.</b> <i>Distractions can cause you to lose control.</i></li> </ol> </li> </ol> | <ol style="list-style-type: none"> <li>2. <b>Electrical safety</b> <ol style="list-style-type: none"> <li>a. <b>Power tool plugs must match the outlet. Never modify the plug in any way. Do not use any adapter plugs with earthed (grounded) power tools.</b> <i>Unmodified plugs and matching outlets will reduce risk of electric shock.</i></li> <li>b. <b>Avoid body contact with earthed or grounded surfaces, such as pipes, radiators, ranges and refrigerators.</b><br/><i>There is an increased risk of electric shock if your body is earthed or grounded.</i></li> </ol> </li> </ol> |
|---|---|

MAINTENANCE

- c. **Do not expose power tools to rain or wet conditions.** *Water entering a power tool will increase the risk of electric shock.*
  - d. **Do not abuse the cord. Never use the cord for carrying, pulling or unplugging the power tool. Keep cord away from heat, oil, sharp edges or moving parts.** *Damaged or entangled cords increase the risk of electric shock.*
  - e. **When operating a power tool outdoors, use an extension cord suitable for outdoor use.** *Use of a cord suitable for outdoor use reduces the risk of electric shock.*
  - f. **If operating a power tool in a damp location is unavoidable, use a ground fault circuit interrupter (GFCI) protected supply.** *Use of a GFCI reduces the risk of electric shock.*
3. **Personal safety**
- a. **Stay alert, watch what you are doing and use common sense when operating a power tool. Do not use a power tool while you are tired or under the influence of drugs, alcohol or medication.** *A moment of inattention while operating power tools may result in serious personal injury.*
  - b. **Use personal protective equipment. Always wear eye protection.** *Protective equipment such as dust mask, non-skid safety shoes, hard hat, or hearing protection used for appropriate conditions will reduce personal injuries.*
  - c. **Prevent unintentional starting. Ensure the switch is in the off-position before connecting to power source and/or battery pack, picking up or carrying the tool.** *Carrying power tools with your finger on the switch or energizing power tools that have the switch on invites accidents.*
  - d. **Remove any adjusting key or wrench before turning the power tool on.** *A wrench or a key left attached to a rotating part of the power tool may result in personal injury.*
  - e. **Do not overreach. Keep proper footing and balance at all times.** *This enables better control of the power tool in unexpected situations.*
  - f. **Dress properly. Do not wear loose clothing or jewelry. Keep your hair, clothing and gloves away from moving parts.** *Loose clothes, jewelry or long hair can be caught in moving parts.*
  - g. **If devices are provided for the connection of dust extraction and collection facilities, ensure these are connected and properly used.** *Use of dust collection can reduce dust-related hazards.*
  - h. **Do not let familiarity gained from frequent use of tools allow you to become complacent and ignore tool safety principles.** *A careless action can cause severe injury within a fraction of a second.*
- i. Only use safety equipment that has been approved by an appropriate standards agency. Unapproved safety equipment may not provide adequate protection. Eye protection must be ANSI-approved and breathing protection must be NIOSH-approved for the specific hazards in the work area.
  - j. Do not lay the tool down until it has come to a complete stop. Moving parts can grab the surface and pull the tool out of your control.
  - k. When using a handheld power tool, maintain a firm grip on the tool with both hands to resist starting torque.
  - l. Do not leave the tool unattended when the Battery Pack is connected. Turn off the tool, and remove the Battery Pack before leaving.
  - m. This product is not a toy. Keep it out of reach of children.
  - n. People with pacemakers should consult their physician(s) before use. Electromagnetic fields in close proximity to heart pacemaker could cause pacemaker interference or pacemaker failure.
  - o. The warnings, precautions, and instructions discussed in this instruction manual cannot cover all possible conditions and situations that may occur. It must be understood by the operator that common sense and caution are factors which cannot be built into this product, but must be supplied by the operator.
4. **Power tool use and care**
- a. **Do not force the power tool. Use the correct power tool for your application.** *The correct power tool will do the job better and safer at the rate for which it was designed.*
  - b. **Do not use the power tool if the switch does not turn it on and off.** *Any power tool that cannot be controlled with the switch is dangerous and must be repaired.*
  - c. **Disconnect the plug from the power source and/or remove the battery pack, if detachable, from the power tool before making any adjustments, changing accessories, or storing power tools.** *Such preventive safety measures reduce the risk of starting the power tool accidentally.*
  - d. **Store idle power tools out of the reach of children and do not allow persons unfamiliar with the power tool or these instructions to operate the power tool.** *Power tools are dangerous in the hands of untrained users.*
  - e. **Maintain power tools and accessories. Check for misalignment or binding of moving parts, breakage of parts and any other condition that may affect the power tool's operation. If damaged, have the power tool repaired before use.** *Many accidents are caused by poorly maintained power tools.*

- f. **Keep cutting tools sharp and clean.** *Properly maintained cutting tools with sharp cutting edges are less likely to bind and are easier to control.*
- g. **Use the power tool, accessories and tool bits etc. in accordance with these instructions, taking into account the working conditions and the work to be performed.** *Use of the power tool for operations different from those intended could result in a hazardous situation.*
- h. **Keep handles and grasping surfaces dry, clean and free from oil and grease.** *Slippery handles and grasping surfaces do not allow for safe handling and control of the tool in unexpected situations.*
5. **Service**
- a. **Have your power tool serviced by a qualified repair person using only identical replacement parts.** *This will ensure that the safety of the power tool is maintained.*
- b. Maintain labels and nameplates on the tool. These carry important safety information. If unreadable or missing, contact Harbor Freight Tools for a replacement.
6. **Battery tool use and care**
- a. **Prevent unintentional starting.** *Ensure the switch is in the off-position before connecting to battery pack, picking up or carrying the power tool. Carrying the power tool with your finger on the switch or energizing power tool that have the switch on invites accidents.*
- b. **Disconnect the battery pack from the power tool before making any adjustments, changing accessories, or storing power tool.** *Such preventive safety measures reduce the risk of starting the power tool accidentally.*
- c. **Recharge only with the charger specified by the manufacturer.** *A charger that is suitable for one type of battery pack may create a risk of fire when used with another battery pack.*
- d. **Use power tools only with specifically designated battery packs.** *Use of any other battery packs may create a risk of injury and fire.*
- e. **When battery pack is not in use, keep it away from other metal objects, like paper clips, coins, keys, nails, screws or other small metal objects, that can make a connection from one terminal to another.** *Shorting the battery terminals together may cause burns or a fire.*
- f. **Under abusive conditions, liquid may be ejected from the battery; avoid contact.** *If contact accidentally occurs, flush with water. If liquid contacts eyes, additionally seek medical help. Liquid ejected from the battery may cause irritation or burns.*
- g. **Do not use a battery pack or power tool that is damaged or modified.** *Damaged or modified batteries may exhibit unpredictable behavior resulting in fire, explosion or risk of injury.*
- h. **Do not expose a battery pack or power tool to fire or excessive temperature.** *Exposure to fire or temperature above 265°F may cause explosion.*
- i. **Follow all charging instructions and do not charge the battery pack or power tool outside of the temperature range specified in the instructions.** *Charging improperly or at temperatures outside of the specified range may damage the battery and increase the risk of fire.*
- j. **Have servicing performed by a qualified repair person using only identical replacement parts.** *This will ensure that the safety of the product is maintained.*
- k. **Do not modify or attempt to repair the power tool or the battery pack except as indicated in the instructions for use and care.**
- l.  The battery Charger gets hot during use. The Charger's heat can build up to unsafe levels and create a fire hazard if it does not receive adequate ventilation, due to an electrical fault, or if it is used in a hot environment. Do not place the Charger on a flammable surface. Do not obstruct any vents on the Charger. **Especially avoid placing the Charger on carpets and rugs; they are not only flammable, but they also obstruct vents under the Charger.** Place the Charger on a stable, solid, nonflammable surface (such as a stable metal workbench or concrete floor) at least 1 foot away from all flammable objects, such as drapes or walls. Keep a fire extinguisher and a smoke detector in the area. Frequently monitor the Charger and Battery Pack while charging.
7. **Lithium Battery Safety Warnings**
-  
- LITHIUM BATTERIES STORE A LARGE AMOUNT OF ENERGY AND WILL VENT FIRE OR EXPLODE IF MISTREATED:**
- a. **Keep Battery Pack dry.**
- b. **DO NOT DO ANY OF THE FOLLOWING TO THE BATTERY PACK:**
- Open,
  - Drop,
  - Short-circuit,
  - Puncture,
  - Incinerate, or
  - Expose to temperatures greater than 265°F.

- c. Charge Battery Pack only according to its Charger's instructions.
- d. Inspect Battery Pack before every use; do not use or charge if damaged.

## 8. Safety instructions for all operations

- a. **Use the auxiliary handle(s).** *Loss of control can cause personal injury.*
- b. **Brace the tool properly before use.** *This tool produces a high output torque and without properly bracing the tool during operation, loss of control may occur resulting in personal injury.*
- c. **Hold the power tool by insulated gripping surfaces, when performing an operation where the cutting accessory or fasteners may contact hidden wiring or its own cord.** *Cutting accessory contacting a "live" wire may make exposed metal parts of the power tool "live" and could give the operator an electric shock.*
- d. Let bit cool before touching, changing or adjusting it. Bits heat up dramatically while in use, and can burn you.
- e. If the drill bit jams, release the Trigger immediately; drill torque can cause injury or break bit.

## 9. Safety Instructions when using long drill bits

- a. **Never operate at higher speed than the maximum speed rating of the drill bit.** *At higher speeds, the bit is likely to bend if allowed to rotate freely without contacting the workpiece, resulting in personal injury.*
- b. **Always start drilling at low speed and with the bit tip in contact with the workpiece.** *At higher speeds, the bit is likely to bend if allowed to rotate freely without contacting the workpiece, resulting in personal injury.*

- c. **Apply pressure only in direct line with the bit and do not apply excessive pressure.** *Bits can bend causing breakage or loss of control, resulting in personal injury.*

## 10. Vibration Safety

This tool vibrates during use.

Repeated or long-term exposure to vibration may cause temporary or permanent physical injury, particularly to the hands, arms and shoulders. To reduce the risk of vibration-related injury:

- a. Anyone using vibrating tools regularly or for an extended period should first be examined by a doctor and then have regular medical check-ups to ensure medical problems are not being caused or worsened from use. Pregnant women or people who have impaired blood circulation to the hand, past hand injuries, nervous system disorders, diabetes, or Raynaud's Disease should not use this tool. If you feel any symptoms related to vibration (such as tingling, numbness, and white or blue fingers), seek medical advice as soon as possible.
- b. Do not smoke during use. Nicotine reduces the blood supply to the hands and fingers, increasing the risk of vibration-related injury.
- c. Wear suitable gloves to reduce the vibration effects on the user.
- d. Use tools with the lowest vibration when there is a choice.
- e. Include vibration-free periods each day of work.
- f. Grip tool as lightly as possible (while still keeping safe control of it). Let the tool do the work.
- g. To reduce vibration, maintain the tool as explained in this manual. If any abnormal vibration occurs, stop use immediately.

## Grounding

### WARNING





#### TO PREVENT ELECTRIC SHOCK AND DEATH FROM INCORRECT GROUNDING:





Check with a qualified electrician if you are in doubt as to whether the outlet is properly grounded. Do not modify the power cord plug provided with the charger. Do not use the charger if the power cord or plug is damaged. If damaged, have it repaired by a service facility before use. If the plug will not fit the outlet, have a proper outlet installed by a qualified electrician.

## Extension Cords

**Note:** Extension cords must not be used with this item's Charger.

# Symbology

	Double Insulated
<b>V</b>	Volts
~	Alternating Current
<b>A</b>	Amperes
n <sub>0</sub> xxxx/min.	No Load Revolutions per Minute (RPM)
	WARNING marking concerning Risk of Eye Injury. Wear ANSI-approved safety goggles with side shields.

	Read the manual before set-up and/or use.
	WARNING marking concerning Risk of Fire. Do not cover Charger ventilation ducts. Charge on fireproof surface only.
	WARNING marking concerning Risk of Electric Shock. Properly connect Charger's power cord to appropriate outlet.
	WARNING marking concerning Risk of Explosion. Do not puncture, short, or open battery packs and do not charge damaged battery packs.

## Specifications

Charger Input Rating	120VAC / 60Hz / 300mA
Battery Rating	18V / 1300mAh
Battery Type	Li-ion
No Load Speed	n <sub>0</sub> = 0-900/min
Chuck Size	3/8" (10mm)

## Setup - Before Use:



Read the **ENTIRE IMPORTANT SAFETY INFORMATION** section at the beginning of this manual including all text under subheadings therein before set up or use of this product.

**Note:** For additional information regarding the parts listed in the following pages, refer to *Parts List and Diagram* on page 11.

## Charging

- Place the Battery Pack on a dry fireproof surface in a room where the temperature is from 50–104° F.

**Note:** If recharging a newly spent Battery Pack, allow it to cool completely before charging.

- Examine the Battery Pack. It must be undamaged, and a Warrior 18V Li-ion type Battery Pack. **Do not charge a cracked, open, or leaking Battery Pack, or charge a non-recommended type of Battery Pack.**
- The charge barrel is designed to fit this battery specifically. If the barrel plug does not fit the battery properly, do not try to insert it. **Do not force a barrel plug into the battery.**
- Plug the Power Supply into a grounded, 120VAC, 60Hz receptacle.
- Connect the Battery Pack to the Charger.

**Note:** The Battery Pack's capacity will increase somewhat during the first few charging cycles. A fully discharged Battery Pack will take about 3 to 5 hours to fully charge. Recharging the Battery Pack for more than 5 hours can damage the battery cells.

- While charging, the Battery Pack and Power Supply may become warm to the touch. This is normal, and does not indicate a problem.
- The red LED on the Battery Pack will light continuously when it is charging and shut off when Battery Pack is fully charged. **Unplug the Charger when finished.**
- Allow the Battery Pack to cool completely before using it.

**WARNING! TO AVOID SERIOUS INJURY: Do NOT use a different Battery Pack to power this Drill.**

# Functions



SAFETY

SETUP

OPERATION

MAINTENANCE

## Operating Instructions



Read the **ENTIRE IMPORTANT SAFETY INFORMATION** section at the beginning of this manual including all text under subheadings therein before set up or use of this product.

SAFETY

### Workpiece and Work Area Set Up

1. Designate a work area that is clean and well lit. The work area must not allow access by children or pets to prevent distraction and injury.
2. Secure loose workpieces using a vise or clamps (not included) to prevent movement while working.
3. There must not be objects, such as utility lines, nearby that will present a hazard while working.

### Tool Changing

#### **⚠️ WARNING**

**TO PREVENT SERIOUS INJURY FROM ACCIDENTAL OPERATION:**  
Make sure that the Trigger is in the off-position and remove its Battery Pack before performing any procedure in this section.

SETUP

#### Drill Bit Installation

**CAUTION!** Wear heavy-duty work gloves to provide protection when inserting and removing drill bits. Drill bits become very hot during use. Do not remove drill bits until the bit has cooled.

1. Drill accepts up to 3/8" standard drill bits. Do not use larger drill bits in this Drill as damage to the gears and/or motor may result. Use a drill bit that is designed for the specific drilling job.
2. To "lock" the trigger mechanism as a safety measure, press down the Direction Switch so that it is in the "center" position. This will prevent the drill turning on accidentally.
3. While holding the ring behind the collar of the Chuck with one hand, rotate the collar of the Chuck counterclockwise until the jaws of the drill are opened enough to fit the drill bit.
4. Use a drill bit designed for the workpiece type. Place the desired drill bit or screwdriver bit into the drill between the Chuck Jaws.
5. Rotate the Chuck counterclockwise until the bit is held securely in place, centered between the Chuck Jaws.
6. Set the desired torque setting by rotating the Torque Adjustment Ring.
  - a. **Use the numbered torque settings from 1 to 20 for driving screws, bolts and nuts.**
    - The torque setting required depends on the being driven. In the case of screws, consider the size, length, and type of material.
    - If a pilot hole has been drilled into the material, a lower torque setting will be required.
    - Fix the torque setting low enough to allow a safety margin. Use a very low torque setting when first driving small screws into soft materials. Then adjust the setting as the proper force required is determined.
  - b. **Use the setting marked by the drill icon for drilling.**

**Note:** In addition to single or double-ended screwdriver bits, adapters with hex shafts with matching socket heads can also be used.

**NOTICE:** Use sharp bits. Dull, bent, or damaged bits will cause stress on the drill and/or break.

OPERATION

### Setting and Testing

1. Ensure Drill Bit is properly installed.
2. Make sure the Direction Switch is in the center OFF position then, insert a fully charged Battery Pack making sure it clicks into place securely.
3. Slide Direction Switch to the right and press Trigger. Test run tool for at least 30 seconds.
4. If abnormal noise/vibration occurs or the bit loosens, have the problem corrected before further use.
5. Release Trigger and set in Direction Switch in center position. Remove Battery Pack.

MAINTENANCE

# General Instructions for Use

1. Make sure the Direction Switch is in the center position, locking the trigger off. Then, insert the Battery Pack making sure it clicks into place securely. To remove Battery Pack, press the Battery Button to release it from the Drill.

**CAUTION!** Most drill bits are designed for use in the forward, clockwise direction. Do not use a drill bit in the opposite direction than it is designed for.

2. When viewing from the back of the drill, slide the Direction Switch to the left for forward drilling/fastening or to the right for reversing the operation. Use the “reverse” setting only to remove screws or to release jammed drill bit.

**WARNING! TO PREVENT SERIOUS INJURY:**

**Do not change direction of rotation while Chuck is rotating.** Wait until Chuck has come to a complete stop before changing direction.

3. If using the Drill to insert or remove screws, position the driver tip in the screw to insert or remove.
4. If drilling a hole, hold the Drill above the area to drill.

5. Press the Trigger to start the drill and release the Trigger to stop the drill. The Work Light will activate when the Trigger is pressed and turn off when the Trigger is released.
6. Turn Torque Adjustment Ring as desired.
7. When inserting or removing a screw or bolt, use slight pressure at first to keep the screw driver bit in the head of the screw or bolt and cause the screw or bolt to thread into or unthread from the material.
8. When drilling a hole, let the Drill do the work, using only enough pressure to follow the drill as it cuts the hole in the material.
9. When finished using the Drill, release the Trigger and center the Direction Switch to lock the trigger mechanism as a safety measure.
10. To prevent accidents, turn off the tool and remove its Battery Pack after use. Clean, then store the tool indoors out of children’s reach.



## Maintenance and Servicing Instructions



Procedures not specifically explained in this manual must be performed only by a qualified technician.

### **WARNING**

**TO PREVENT SERIOUS INJURY FROM ACCIDENTAL OPERATION:**  
Make sure that the Trigger is in the off-position and remove its Battery Pack before performing any procedure in this section.

**TO PREVENT SERIOUS INJURY FROM TOOL FAILURE:**  
Do not use damaged equipment. If abnormal noise or vibration occurs, have the problem corrected before further use.

## Cleaning, Maintenance, and Lubrication

- BEFORE EACH USE**, inspect the general condition of the tool. Check for:
  - leaking, swollen, or cracked Battery Pack,
  - loose hardware,
  - misalignment or binding of moving parts,
  - cracked or broken parts, and
  - any other condition that may affect its safe operation.
- AFTER USE**, wipe external surfaces of the tool with clean cloth.
- Li-Ion BATTERY MUST BE RECYCLED OR DISPOSED OF PROPERLY.  
Do not short, incinerate or open battery.
- Disconnect battery pack and store battery pack, charger, and tool in dry, indoor area out of reach of children and away from metal objects (i.e., paperclips, coins) to prevent shorting.

## Troubleshooting

Problem	Possible Causes	Likely Solutions
Tool will not start.	<ol style="list-style-type: none"> <li>Battery Pack not properly connected.</li> <li>Battery Pack not properly charged.</li> <li>Battery Pack burnt-out.</li> <li>Internal damage or wear. (Carbon brushes or Trigger, for example.)</li> </ol>	<ol style="list-style-type: none"> <li>Remove Battery Pack, make sure there are no obstructions, reinsert the Battery Pack according to its shape (it should only fit one way), and press firmly until the Battery Pack locks in place.</li> <li>Make sure Charger is connected and operating properly. Give enough time for Battery Pack to recharge properly.</li> <li>Dispose of old Battery Pack properly or recycle. Replace Battery Pack.</li> <li>Have technician service tool.</li> </ol>
Tool operates slowly.	<ol style="list-style-type: none"> <li>Forcing tool to work too fast.</li> <li>Battery Pack wearing out.</li> </ol>	<ol style="list-style-type: none"> <li>Allow tool to work at its own rate.</li> <li>Dispose of old Battery Pack properly or recycle. Replace Battery Pack.</li> </ol>
Performance decreases over time.	<ol style="list-style-type: none"> <li>Carbon brushes worn or damaged.</li> <li>Bit dull or damaged.</li> </ol>	<ol style="list-style-type: none"> <li>Have qualified technician replace brushes.</li> <li>Keep bits sharp. Replace as needed.</li> </ol>
Excessive noise or rattling.	Internal damage or wear. (Carbon brushes or bearings, for example.)	Have technician service tool.
Overheating.	<ol style="list-style-type: none"> <li>Forcing tool to work too fast.</li> <li>Bit dull or damaged.</li> <li>Blocked motor housing vents.</li> </ol>	<ol style="list-style-type: none"> <li>Allow tool to work at its own rate.</li> <li>Keep bits sharp. Replace as needed.</li> <li>Wear ANSI-approved safety goggles and NIOSH-approved dust mask/respirator while blowing dust out of motor using compressed air.</li> </ol>



Follow all safety precautions whenever diagnosing or servicing the tool.  
Disconnect Battery Pack and Charger power supply before service.

**PLEASE READ THE FOLLOWING CAREFULLY**

THE MANUFACTURER AND/OR DISTRIBUTOR HAS PROVIDED THE PARTS LIST AND ASSEMBLY DIAGRAM IN THIS MANUAL AS A REFERENCE TOOL ONLY. NEITHER THE MANUFACTURER OR DISTRIBUTOR MAKES ANY REPRESENTATION OR WARRANTY OF ANY KIND TO THE BUYER THAT HE OR SHE IS QUALIFIED TO MAKE ANY REPAIRS TO THE PRODUCT, OR THAT HE OR SHE IS QUALIFIED TO REPLACE ANY PARTS OF THE PRODUCT. IN FACT, THE MANUFACTURER AND/OR DISTRIBUTOR EXPRESSLY STATES THAT ALL REPAIRS AND PARTS REPLACEMENTS SHOULD BE UNDERTAKEN BY CERTIFIED AND LICENSED TECHNICIANS, AND NOT BY THE BUYER. THE BUYER ASSUMES ALL RISK AND LIABILITY ARISING OUT OF HIS OR HER REPAIRS TO THE ORIGINAL PRODUCT OR REPLACEMENT PARTS THERETO, OR ARISING OUT OF HIS OR HER INSTALLATION OF REPLACEMENT PARTS THERETO.

**Parts List and Assembly Diagram**

Part	Description	Qty
1	Chuck Screw	1
2	Chuck	1
3	Screw	4
4	Front Cover	1
5	Torque Adjustment Ring	1
6	Gearbox	1
7	Right Housing	1
8	Housing Screw	9
9	Switch	1

Part	Description	Qty
10	Circuit Board	1
11	Terminal	1
12	LED	1
13	Trigger	1
14	Direction Switch	1
15	Left Housing	1
16	Battery Pack	1
17	Charger (not shown)	1

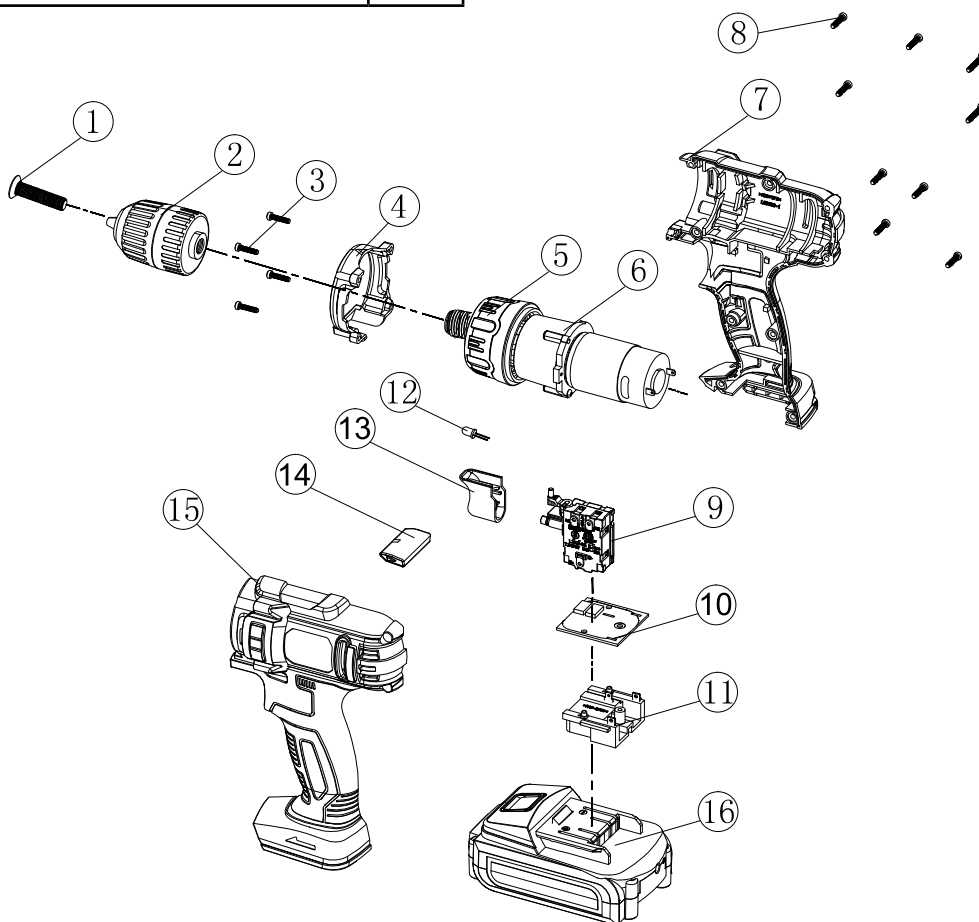

Record Product's Serial Number Here: \_\_\_\_\_

**Note:** If product has no serial number, record month and year of purchase instead.

**Note:** Some parts are listed and shown for illustration purposes only, and are not available individually as replacement parts. Specify UPC 193175440501 when ordering parts.

## Limited 90 Day Warranty

Harbor Freight Tools Co. makes every effort to assure that its products meet high quality and durability standards, and warrants to the original purchaser that this product is free from defects in materials and workmanship for the period of 90 days from the date of purchase. This warranty does not apply to damage due directly or indirectly, to misuse, abuse, negligence or accidents, repairs or alterations outside our facilities, criminal activity, improper installation, normal wear and tear, or to lack of maintenance. We shall in no event be liable for death, injuries to persons or property, or for incidental, contingent, special or consequential damages arising from the use of our product. Some states do not allow the exclusion or limitation of incidental or consequential damages, so the above limitation of exclusion may not apply to you. THIS WARRANTY IS EXPRESSLY IN LIEU OF ALL OTHER WARRANTIES, EXPRESS OR IMPLIED, INCLUDING THE WARRANTIES OF MERCHANTABILITY AND FITNESS.

To take advantage of this warranty, the product or part must be returned to us with transportation charges prepaid. Proof of purchase date and an explanation of the complaint must accompany the merchandise. If our inspection verifies the defect, we will either repair or replace the product at our election or we may elect to refund the purchase price if we cannot readily and quickly provide you with a replacement. We will return repaired products at our expense, but if we determine there is no defect, or that the defect resulted from causes not within the scope of our warranty, then you must bear the cost of returning the product.

This warranty gives you specific legal rights and you may also have other rights which vary from state to state.

