

EcoStar VS



Model: 1B-ESP2300HVS EcoStar Variable Speed Pump

The EcoStar Variable Speed Pump is specifically engineered for the demanding requirements of today's in-ground swimming pool/spa that is equipped with large capacity filters, heaters, and pool cleaning equipment. The variable speed, totally enclosed permanent magnet motor, combined with its advanced hydraulic design, optimizes the three essential pump elements to deliver superior flow, energy efficiency, and quietness.

Owner's Manual

NOTE: To prevent potential injury and to avoid unnecessary service calls, read this manual carefully and completely.

SAVE THIS INSTRUCTION MANUAL

Hayward Pool Products (Australia) Pty Ltd.

Melbourne-Sydney-Brisbane-Perth

Email: sales@hayward-pool.com.au Website: www.hayward-pool.com.au

P.O. Box 4384, Dandenong South, VIC. 3164

ABN 66 083 413 414

Sales Ph 1300POOLS1 Fx 1300POOLS2

IMPORTANT SAFETY INSTRUCTIONS

Before installing or servicing this electrical equipment, turn power supply OFF.



⚠ WARNING – Read and follow all instructions in this owner’s manual and on the equipment. Failure to follow instructions can cause severe injury and/or death.

⚠ WARNING – This product should be installed and serviced only by a qualified professional.

⚠ CAUTION – All electrical wiring **MUST** be performed by a qualified electrical contractor, and must conform to local electrical regulations and AS/NZS 3000 Wiring Rules.

Use of non-Hayward replacement parts voids warranty.

ATTENTION INSTALLER – THIS MANUAL CONTAINS IMPORTANT INFORMATION ABOUT THE INSTALLATION, OPERATION, AND SAFE USE OF THIS PUMP THAT MUST BE HONOURED THROUGH TO THE END USER OF THIS PRODUCT. FAILURE TO READ AND FOLLOW ALL INSTRUCTIONS COULD RESULT IN SERIOUS INJURY.

⚠ WARNING – This appliance is not intended for use by persons (including children) with reduced physical, sensory or mental capabilities, or lack of experience and knowledge, unless they have been given supervision or instruction concerning use of the appliance by a person responsible for their safety.

Children should be supervised to ensure that they do not play with the appliance.

⚠ CAUTION – This pump is intended for use on permanently installed swimming pools and may also be used with hot tubs and spas if so marked. Do NOT use with storable pools. A permanently installed pool is constructed in or on the ground or in a building such that it cannot be readily disassembled for storage. A storable pool is constructed so that it is capable of being readily disassembled for storage and reassembled to its original integrity. Though this product is designed for outdoor use, it is strongly advised to protect the electrical components from the weather. Select a well-drained area, one that will not flood when it rains. It requires free circulation of air for cooling. Do not install in a damp or non-ventilated location. If installed within an outer enclosure or beneath the skirt of a hot tub or spa, adequate ventilation and free circulation of air must be provided to prevent overheating of the motor.

⚠ WARNING – Pool and spa components have a finite life. All components should be inspected frequently and replaced at least every ten years, or if found to be damaged, broken, cracked, missing, or not securely attached.

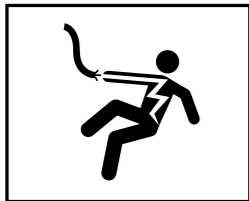

⚠ WARNING – Risk of Electric Shock. All electrical wiring must be performed by a qualified electrical contractor, and must conform to electrical regulations and AS/NZ 3000 Wiring Rules. All electrical circuits must be supplied through a Residual Current Device - RCD (Safety Switch), with a residual operating current of 30mA. Hazardous voltage can shock, burn and cause death or serious property damage. To reduce the risk of electric shock, do NOT use an extension cord to connect unit to the electricity supply.

⚠ WARNING – To reduce the risk of electric shock replace damaged wiring immediately. Locate the power cord to prevent abuse from lawn mowers, hedge trimmers and other equipment.

If the power cord is damaged, it must be replaced by the manufacturer, its service agent or similarly qualified person in order to avoid hazard.

⚠ WARNING – Never operate the circulation system at more than (50PSI) 344Kpa maximum.

WARNING – Automatic restart. The pump motor is automatically protected from overload and overheating. If such an error occurs the controller will automatically try to restart the pump. If a power failure occurs while the pump is running, it will automatically restart once the power has been restored.

IMPORTANT SAFETY INSTRUCTIONS

Before installing or servicing this electrical equipment, turn power supply OFF.



⚠ WARNING – Hazardous Pressure. Pool and spa water circulation systems operate under hazardous pressure during start-up, normal operation, and after pump shut-off. Stand clear of circulation system equipment during pump start-up. Failure to follow safety and operation instructions could result in violent separation of the pump housing and cover due to pressure in the system. This separation which could cause property damage, severe personal injury, or death. Before servicing pool and spa water circulation system, all system and pump controls must be in the off position and the Filter Manual Air Relief Valve must be in the open position. Before starting the system pump, all valves must be set in a position to allow system water to return back to the pool. Do not change the Filter Control Valve position while the system pump is running. Before starting the system pump, fully open the Filter Manual Air Relief Valve. Do not close the Filter Manual Air Relief valve until all the air is expelled and a steady stream of water is discharged from the valve. All suction and discharge valves **MUST** be **OPEN** when starting the circulation system. Failure to do so could result in severe personal injury and/or property damage.



⚠ WARNING – Separation Hazard. Failure to follow safety and operation instructions could result in violent separation of pump components. Strainer cover must be properly secured to pump housing with the strainer cover lock ring. Before servicing pool and spa circulation system, all system and pump controls must be in off position and the Filter Manual Air Relief Valve must be in open position. Do not operate pool and spa circulation system if system components are not assembled properly, damaged, or missing. Do not operate pool and spa circulation system unless the Filter Air Relief Valve body is in locked position within the filter upper body. All suction and discharge valves **MUST** be **OPEN** when starting the circulation system. Failure to do so could result in severe personal injury and/or property damage.

⚠ WARNING – Suction Entrapment Hazard. Suction in suction outlets and/or suction outlet covers, which are damaged, broken, cracked, missing, or unsecured cause severe injury and/or death due to the following entrapment hazards.



Hair Entrapment - Hair can become entangled in suction outlet cover.



Limb Entrapment - A limb inserted into an opening of a suction outlet sump or suction outlet cover that is damaged, broken, cracked, missing, or not securely attached can result in a mechanical bind or swelling of the limb.



Body Suction Entrapment - A differential pressure applied to a large portion of the body or limbs can result in an entrapment.



Evisceration/Disembowelment - A negative pressure applied directly to the intestines through an unprotected suction outlet sump or suction outlet cover which is damaged, broken, cracked, missing, or unsecured can result in evisceration/disembowelment.

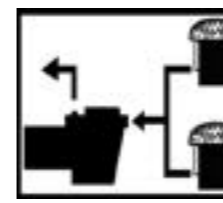

Mechanical Entrapment - There is potential for jewelry, swimsuits, hair decorations, fingers, toes, or knuckles to be caught in an opening of a suction outlet cover resulting in mechanical entrapment.

⚠ WARNING – To Reduce the risk of Entrapment Hazards:

- When outlets are small enough to be blocked by a person, a minimum of two functioning suction outlets per pump must be installed. Suction outlets in the same plane (i.e. floor or wall), must be installed a minimum of 0.91 metres or three feet (3') apart, as measured from near point to near point to avoid dual blockage by a user.

- Dual suction fittings shall not be located on seating areas or on the backrest for such seating areas.
- Never use pool or spa if any suction outlet component is damaged, broken, cracked, missing, or not securely attached.
- Replace damaged, broken, cracked, missing, or not securely attached suction outlet components immediately.
- In addition to installing two or more suction outlets per pump, follow all national, state and local codes applicable.
- Installation of a vacuum release or vent system, which relieves entrapping suction, is recommended.

Introduction

This manual contains information for the proper installation and operation of the Hayward EcoStar Variable Speed Pump. The instructions in this manual MUST be followed precisely. Failure to install according to the defined instructions will void warranty.

Product Dimensions *Note: All dimensions in millimetres

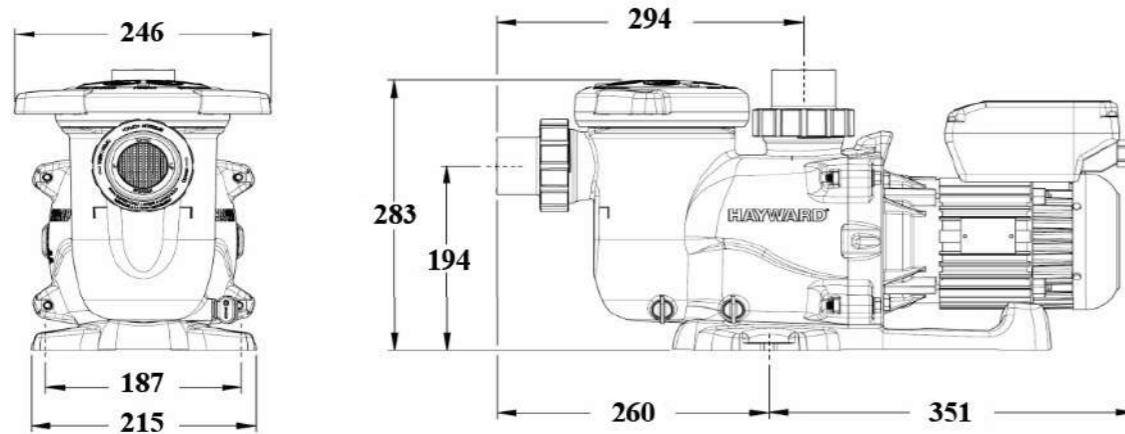

Installation Instructions

WARNING – This product should be installed and serviced only by a qualified professional.

Pump Location

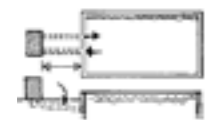

Locate pump as close to pool as practical and run suction lines as direct as possible to reduce friction loss. Suction lines should have continuous slope upward from lowest point in line. Joints must be tight (but not over-tightened). Suction line must not be less than 50mm in diameter and must be equal to or larger in diameter than the discharge line diameter.

Though the pump is designed for outdoor use, it is advised to place pump and filter in the shade to shield them from continuous direct heat. Select a well-drained area that will not flood when it rains. Do NOT install pump and filter in a damp or non-ventilated location. Keep motor clean. Pump motors require free circulation of air for cooling.

Pump Mounting

Install pump on a level concrete slab or other rigid base to meet all local and national codes. Secure pump to base with screws or bolts to further reduce vibration and stress on pipe joints. The base must be level, rigid, and vibration free.

Pump mount must:

- Allow pump inlet height to be as close to water level as possible.
- Allow use of short, direct suction pipe (to reduce friction losses).
- Allow for valves in suction and discharge piping.
- Be protected from excess moisture and flooding.
- Allow adequate access for servicing pump and piping.

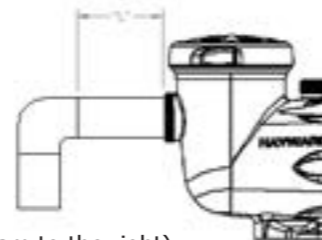

***NOTE:** It is recommended that a minimum length of straight piping (shown as "L" in diagram to the right), equivalent to 5 pipe size diameters, be used between the pump suction inlet and any plumbing fittings (elbows, valves, ect).

Plumbing

Only use Teflon tape or an elastomeric thread sealant suitable for plastic, to seal threaded connections on moulded plastic components. All plastic fittings must be new or thoroughly cleaned before use.

Note - Do Not use Plumbers Pipe Dope or Plumbers Putty as it may cause cracking of the plastic components. The pump suction and outlet ports have moulded in-thread stops. Do NOT attempt to force threaded connector fitting past this stop. It is only necessary to tighten fittings enough to prevent leakage. Tighten fitting by hand and then use a tool to engage the fitting an additional 1½ turns. Do NOT over-tighten fitting or you may cause damage. If a leak occurs, remove the fitting and remove all traces of the sealing compound from thread. Re apply fresh sealing compound and re-install the threaded fitting.

Note - If the pump is being installed using the standard Hayward Universal Union that is supplied with the pump then there is no need to apply any type of thread sealant. The union gasket supplied is suffice to seal.

Fittings (elbows, tees, valves, ect.) restrict flow. For better efficiency use the fewest possible fittings. Avoid fittings that could cause an air trap.

WARNING - If circulation equipment must remain in the plumbing system during water pressure test, do not apply more than 68 Kpa (10psi) pressure to the system. Be sure water pressure has been released, using the filter manual air relief valve, before removing the pump strainer cover.

Electrical

WARNING – Risk of Electric Shock. All electrical wiring must be performed by a qualified electrical contractor, and must conform to electrical regulations and AS/NZS 3000 Wiring Rules. All electrical circuits must be supplied through a Residual Current Device - RCD (Safety Switch), with a residual operating current of 30mA. Hazardous voltage can shock, burn and cause death or serious property damage. To reduce the risk of electric shock, do NOT use an extension cord to connect unit to the electricity supply, or if the supply cord is damaged, it must be replaced by the manufacture, its service agent or similarly qualified persons in order to avoid a hazard.

CAUTION - Lightning Surge Protector Recommended. Due to the VSP containing electronic components like a personal computer, Hayward recommends that a surge protector device (SPD) is installed on the feed circuit to the pump by a qualified electrical contractor in accordance with AS/NZS 3000 Australian Wiring Rules.

Bonding

All conductive parts within and around the pool shall be connected together by equipotential bonding conductors and connected to the protective earthing conductor of the electrical equipment as stated in AS/NZS 3000.

Electrical - specifications

The Variable Speed Drive is fully electronic. Consisting of an integrated power module (IPM) and controller, hard and software with a digital signal processor (DSP). The mains inputs are supplied with a power factor correction (PFC) and EMC filters. The Variable Speed Drive controls a Totally Enclosed, Fan Cooled, Permanent Magnet Motor.

- Voltage: 220 - 240 VAC ± 10% of the mean rated voltage while running, 50Hz Single Phase
- Current: 8.65 amps
- Power (output): 1,990 W
- Speed Range: 600-2850 rpm
- Ambient temperature: 0 to 40°C
- Protection class: IP X5

WARNING - Damaged Supply Cord

If the power supply cord is damaged it must be replaced by the manufacturer, its service agent or similar qualified person in order to avoid a hazard.

User Interface Overview



The User Interface is equipped with a membrane keyboard and a digital display with five 7-segment digits.

Preset Speeds

Buttons labeled V1 through V3 can be used to run the pump at a predetermined speed for a certain length of time. Preset Speed settings can be quickly updated using the ▲ and ▼ arrow buttons to change the speed and then pressing both ▲ and ▼ arrow buttons simultaneously to save the new speed setting. When a speed is selected, the LED above the button will illuminate to indicate operation.

Start Up

This pump is factory set to start in prime mode for two minutes. When Priming has finished the pump will then switch to speed V3. The pump will run at this speed (adjustable) for its programmed time (adjustable) then switch to speed V1. The pump will then remain at speed V1 until power is cycled or another speed is selected.

Factory Default Speeds and Run Times

- Prime Mode: 3000 rpm / 2 minute duration
- V1: 1190 rpm
- V2: 2280 rpm / 4 hour duration
- V3: 2850 rpm / 5 minute duration

Note: The duration of the Prime Mode is adjustable between 0 minutes and 4 minutes. If adjusted to zero the Prime Mode is disabled and the pump will start in speed V3. The speed of the Prime Mode is non-adjustable. Speeds V1 through V3 are adjustable between 600 rpm and 2850 rpm. The Run Timers on speeds V2 and V3 are adjustable between 5 minutes and 18 hours in 5 minute increments.

Menu / navigation buttons

The DISP/FUNC button will scroll through the home screen information when pressed. If the DISP/FUNC button is held it will enter the controller into **configuration mode**. The ▲ and ▼ arrow buttons are used to change parameters within configuration mode.

Power LED

The Power LED will remain illuminated while the unit has power unless the pump is experiencing an error. When the pump experiences an error the **Power LED will "FLASH"** and a code will be displayed.

Run / Stop

This button is used to stop the pump to allow strainer basket cleaning, etc. When this button is pressed the pump will remain stopped and the remaining time for the current speed will be paused until the button is pressed a second time to resume normal operation.

Configuration Menu Outline

- Prime Mode run time** - default 2 minutes / range 0 - 4 minutes in 1 second increments;
- V1 Speed** - default 1190 rpm / range 600 - 3000 rpm in 10 rpm increments;
- V2 Speed** - default 2280 rpm / range 600 - 3000 rpm in 10 rpm increments;
- V2 Timer** - default 4 hours / range 5 minutes - 18 hours in 5 minute increments;
- V3 Speed** - default 2850 rpm / range 600 - 3000 rpm in 10 rpm increments;
- V3 Timer** - default 5 minutes / range 5 minutes - 18 hours in 5 minute increments;
- RS485 Mode Selection** - default 'no' / range 'yes' or 'no';

Note: Scroll through a - h using **DISP/FUNC** button and adjust each parameter using the ▲ and ▼ arrow buttons.

Holding the arrow buttons down will enable fast scrolling of the values.

Initial Start Up

After plumbing and connection is complete, the VSD must be configured prior to use. When power is applied to the drive, the four informational screens below are displayed in order from left to right.

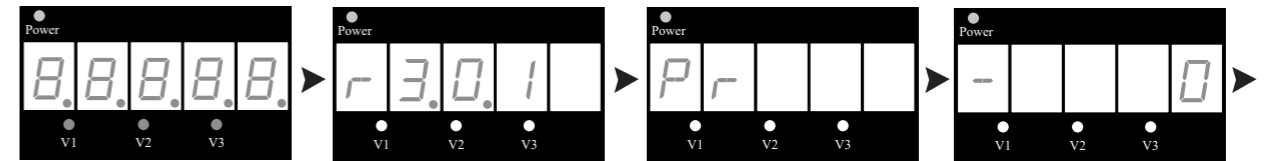

This is shown on the screen when the pump is powered up.

This is the second screen displayed and shows the motor software revision.

This screen is only displayed if Prime Mode is activated.

When Prime Mode is active this screen ramps up to 3000 rpm with a rotating circle in block 1

Note: If the Prime Mode is disabled, after informational screens 1 and 2 the standard running screen for speed V3 will be displayed bypassing informational screens 3 and 4.

By pressing the **DISP/FUNC** button during the Priming Cycle you will be able to scroll through the screens shown below in order from left to right.

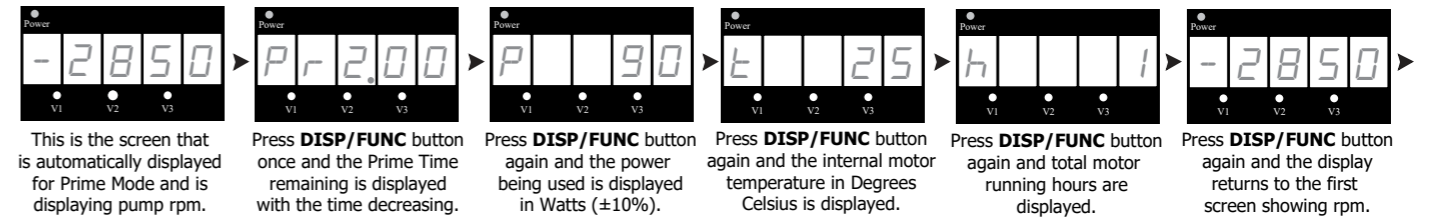

This is the screen that is automatically displayed for Prime Mode and is displaying pump rpm.

Press **DISP/FUNC** button once and the Prime Time remaining is displayed with the time decreasing.

Press **DISP/FUNC** button again and the power being used is displayed in Watts (±10%).

Press **DISP/FUNC** button again and the internal motor temperature in Degrees Celsius is displayed.

Press **DISP/FUNC** button again and total motor running hours are displayed.

Press **DISP/FUNC** button again and the display returns to the first screen showing rpm.

Once the Priming Cycle has finished and the pump is operating in any speed from V1 through V3, by pressing the **DISP/FUNC** button you will be able to scroll through the screens shown below in order from left to right.

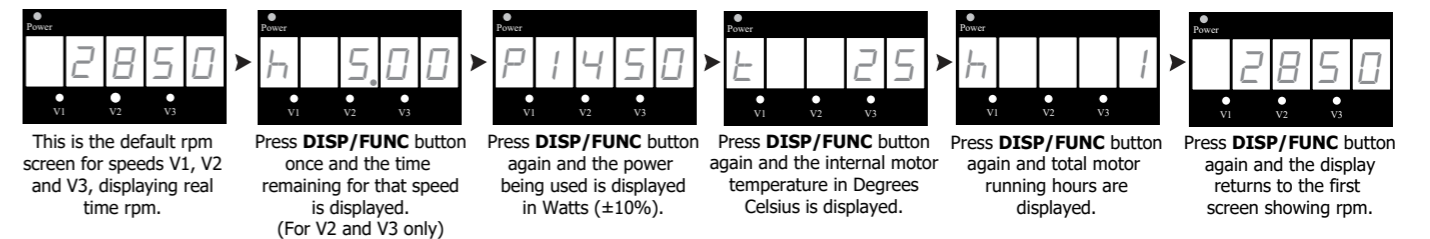

This is the default rpm screen for speeds V1, V2 and V3, displaying real time rpm.

Press **DISP/FUNC** button once and the time remaining for that speed is displayed. (For V2 and V3 only)

Press **DISP/FUNC** button again and the power being used is displayed in Watts (±10%).

Press **DISP/FUNC** button again and the internal motor temperature in Degrees Celsius is displayed.

Press **DISP/FUNC** button again and total motor running hours are displayed.

Press **DISP/FUNC** button again and the display returns to the first screen showing rpm.

Configuration Menu

To ensure that the pump speeds and timers are setup according to the site specific individual requirements, access the Configuration Menu as shown below:

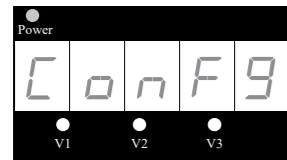

Press and hold the **DISP/FUNC** button for several seconds until the ConFg screen appears.



The first Configuration Menu screen is used to adjust the duration of the priming time. Press or hold down either **▲** or **▼** arrow button to adjust the run time between zero and 4 minutes. A setting of zero disables the priming cycle. Press **DISP/FUNC** button to advance to next screen.



This screen allows the speed of V1 to be adjusted between 600 rpm and 3000 rpm by pressing or holding down either **▲** or **▼** arrow button. Press **DISP/FUNC** button to advance to the next screen.



This screen allows the speed of V2 to be adjusted between 600 rpm and 3000 rpm by pressing or holding down either **▲** or **▼** arrow button. Press **DISP/FUNC** button to advance to the next screen.



This screen allows the timer of V2 to be adjusted between 5 minutes and 18 hours by pressing or holding down either **▲** or **▼** arrow button. Press **DISP/FUNC** button to advance to the next screen.



This screen allows the speed of V3 to be adjusted between 600 rpm and 3000 rpm by pressing or holding down either **▲** or **▼** arrow button. Press **DISP/FUNC** button to advance to the next screen.

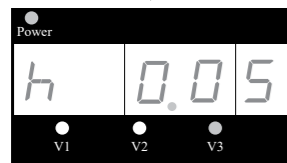

This screen allows the timer of V3 to be adjusted between 5 minutes and 18 hours by pressing or holding down either **▲** or **▼** arrow button. Press **DISP/FUNC** button to advance to the next screen.

The last few screens in the Configuration Menu allow the user to alternate between "Stand Alone" Mode and RS485 Control Mode. RS485 Control Mode allows the pump to be controlled by a Hayward Control System when connected.

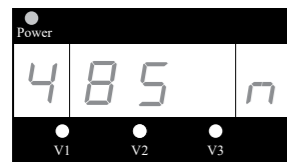

This is the display for RS485 Control Mode selection. The current display shows that RS485 Control Mode is NOT selected and is in "Stand Alone" Mode. To leave the pump in "Stand Alone" Mode press **DISP/FUNC** to exit the Configuration Menu. Press either of the **▲** or **▼** arrow buttons to change modes.

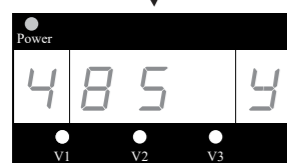

This screen shows that RS485 Control Mode has now been selected. To save this selection, press the **DISP/FUNC** button. The pump will now enter RS485 Control Mode.

Saving Configuration Settings

When in configuration mode, the LED for the speed being configured will be constantly "**FLASHING**". When exiting configuration mode all three of the speed LED's will "**FLASH**" to signify that all settings have been saved. If the configuration mode has not been completely exited, after 2 minutes of inactivity the controller will save all of the settings excluding the current screen settings and exit configuration mode.

Quick Speed Change

Use the **▲** and **▼** arrow buttons to quickly adjust the current speed that the pump is running at. When a quick speed change is performed the LED for the changed speed will be "**FLASHING**". The LED will continue to flash until the speed is saved, or until the timer runs out for that speed or the power is cycled to the pump. The new speed is only saved by pressing simultaneously the **▲** and **▼** arrow buttons and then the LED for that speed will illuminate solid.

Establishing Connection with a Hayward Control System (e.g OmniLogic)

Firstly ensure the pump has been correctly wired to the Hayward control system. The pump must then be in RS485 Control Mode and connected to a GPO. The screens below are what will be shown whilst the pump establishes a connection and begins communicating with the Hayward control system.

Please Note: For full OmniLogic and RS485 connection instructions please refer to the Communication Cable Manual 30-LITNSB019

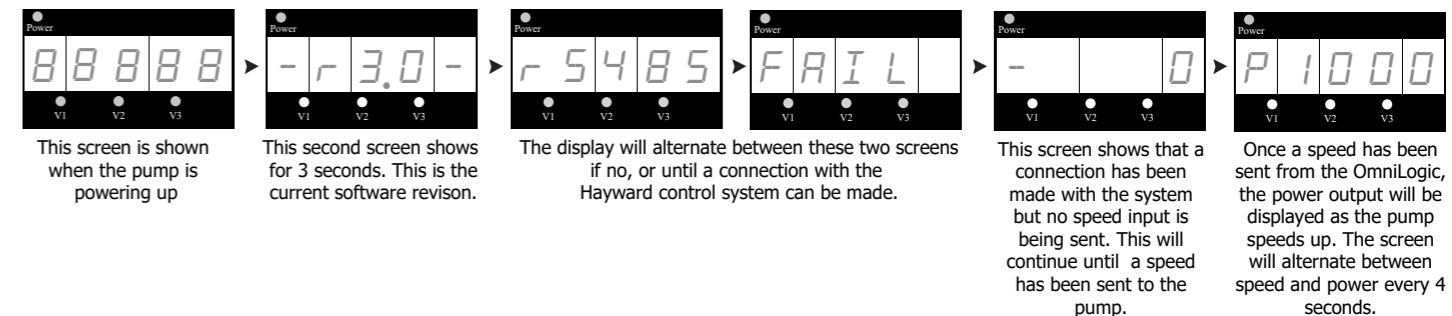

This screen is shown when the pump is powering up

This second screen shows for 3 seconds. This is the current software revision.

The display will alternate between these two screens if no, or until a connection with the Hayward control system can be made.

This screen shows that a connection has been made with the system but no speed input is being sent. This will continue until a speed has been sent to the pump.

Once a speed has been sent from the OmniLogic, the power output will be displayed as the pump speeds up. The screen will alternate between speed and power every 4 seconds.

OmniLogic to VSP - HUA Access Guide

Overview

Configuring the OmniLogic to control your variable speed pump (VSP) requires multiple steps that must be performed in sequence. If the procedure is not followed in the proper order, the pump will not operate as intended. Typically, the configuration of the VSP would take place during the initial configuration of the OmniLogic. Read this guide and the Installation Manual before attempting to install your VSP.

Wiring

The OmniLogic can control the VSP whether it's plugged directly into an outside GPO or to one of the OmniLogic's HV relay controlled GPOs. Determine which method will be used and then install the pump according to the Installation Manual.

Configuration

Configuration steps will vary depending on which wiring method is used. In both cases, the pump will have to be powered before the OmniLogic can initiate communication. Once the VSP has been discovered and configured, the OmniLogic will take control based on the user settings (see OmniLogic Operation Manual). Read carefully and follow the steps below when installing the variable speed pump.

If VSP is Plugged into an Outside GPO

If powering from an outside GPO, it's best to power the VSP continuously (we recommend NOT using a timeclock). If the VSP will not be powered continuously, ensure that it will be powered throughout the intended run time.

1. Turn on power to the VSP. If this is the first time it's been powered, the pump will start in prime mode. If so, go to the pump and press the **RUN/STOP** button once to put it in Standby mode.
2. On the VSP, enter the **CONFIG** Menu by holding down the **DISP/FUNC** button until **CONFIG** is displayed and then scroll through by repeatedly pressing the **DISP/FUNC** button until "485" is displayed.
3. Use the **UP** or **DOWN** arrow button to toggle between "y" & "n" so the display reads "485 y".

OmniLogic to VSP - HUA Access Guide (Cont.)

4. Press the **DISP/FUNC** button to save the selection. The VSP is now in RS485 Controlled Mode and will allow the OmniLogic to discover the HUA of the pump.
5. At the OmniLogic, enter the Configuration Wizard (no password is needed during initial configuration). If a password is required, use your MSP ID which can be found in System Info (see Operation Manual).
6. Advance through the Configuration Wizard. When you get to "**Filter Pumps**", configure the VSP as described in the OmniLogic Installation Manual.
7. Save and exit the Configuration Wizard.
8. You can now set a schedule for the VSP (refer to the OmniLogic Operation Manual).

If VSP is Plugged into an OmniLogic HV Relay Controlled GPO

If the VSP is controlled by one of the OmniLogic's HV relays, it will not be powered until after the assigned HV relay is configured and set to operate. Without power to the pump, the OmniLogic will not be able to discover the VSP. Therefore, configuring the pump requires two separate configurations; one for the HV relay (performed first) and one for the VSP (performed last).

1. Enter the OmniLogic Configuration Wizard (no password needed during initial configuration). If a password is required, use your MSP ID which can be found in System Info and write it down (see Operation Manual).
2. Advance through the Configuration Wizard. When you get to "**Filter Pumps**", add the VSP but skip over blank HUA screen.
3. Continue through the Configuration Wizard. When you get to "**Accessories**", determine which HV relay is wired to the VSP GPO and configure it as an accessory named "**VSP Power**".
4. Finish the configuration, save and exit the Configuration Wizard.
5. From the Home Screen, go to the "**VSP Power**" accessory and set a schedule to run from 12:00am to 11:59pm (this is the longest daily timer possible). This schedule controls the input power to the pump only, not the actual run time of the pump (see Step 12). Be aware that the pump will receive power immediately after this schedule is set. If this is the first time that the VSP has been powered, it will start in prime mode. If so, go to the pump and press the **RUN/STOP** button once to put it in Standby mode.
6. On the VSP, enter the **CONFIG** Menu by holding down the **DISP/FUNC** button until **CONFIG** is displayed and then scroll through by repeatedly pressing **DISP/FUNC** button until "**rS485**" is displayed.
7. Use the **UP** or **DOWN** arrow button to toggle between "**y**" & "**n**" so the display reads "**rS485 y**".
8. Press the **DISP/FUNC** button to save the selection. The VSP is now in RS485 Controlled Mode and will allow the OmniLogic to discover the HUA of the pump.
9. On the OmniLogic go to System Info and write down your MSP ID. (this is the password when you enter the Configuration Wizard)
10. Enter the Configuration Wizard and edit the existing configuration. Go back to the VSP configuration and there should now be an HUA for the pump.
11. Select the VSP's HUA, (for cross-reference the HUA is listed on the pump label found on the user interface) save and exit the Configuration Wizard.
12. You can now set a schedule for the VSP (refer to the OmniLogic Operation Manual).

Start Up & Operation

Prior to start-up, if it is necessary to perform a water pressure test prior to the initial use to ensure the plumbing system is functioning properly, then the following criteria should be maintained for this test:

- Have a professional perform this test.
- Ensure all Hayward pump and system components are removed from the system prior to performing the test.

⚠ WARNING - All suction and discharge valves **MUST** be OPEN, as well as the Filter Air Relief Valve (if available) on filter, when starting the circulating pump system. Failure to do so could result in severe personal injury.

Priming the pump

Make sure to release all the pressure from the pump and the piping system using the Filter Manual Air Relief Valve (if available). Close the valves in the suction and discharge lines and remove the strainer cover. Fill the strainer housing with water to suction pipe level. If water leakage occurs from anywhere on the pump or filter, **DO NOT** start the pump. If no leakage occurs re-install the strainer cover and ensure the Suction, Discharge, and Filter Air Relief Valves are open. Stand at least 2.5 metres from the pump and/or filter and proceed with starting the pump.

⚠ ATTENTION - **Never operate the pump without water.** Water acts as a coolant and lubricant for the mechanical shaft seal. Never run the pump dry. Running the pump dry may damage seals, causing leakage, flooding, and **voids warranty**. **Do NOT** add chemicals to pool/spa system directly to the pump housing or directly in front of the pump suction. Adding undiluted chemicals may damage the pump and **voids warranty**.

Starting the pump

To start the pump, make sure all the suction and discharge valves are open, and the Manual Air Relief Valve on the filter is fully open (if filter has one). Turn the power on at the power point and then press the "**Run/Stop**" button on the motor interface. Stand back while the pump primes. Due to system variances like suction lift, and the length of the suction line, five minutes is not an unreasonable length of time for priming. Only close the Filter Manual Air Relief Valve once a steady stream of water (not air or air mixed with water) is discharging from the valve.

To adjust the speed of the pump please refer to the "User Interface Overview" on pages six (6) through nine (9). If the pump will not start or prime please refer to the troubleshooting section on page fifteen (15).

Selecting the correct speed setting

To maximise efficiency and performance it is important to select the appropriate speed setting for your specific requirements. As shown on page eight (8) in the user configuration menu, speed V1, V2, and V3 can be easily adjusted and set at any speed from 600 rpm to 2850 rpm. Please consult a pool professional for correct sizing, model selection, speed adjustment/setting, and installation advice to suit your pool.

This table shows the approximate flow rate in litres per minute at the factory speed settings.

Note: All flow rates in this table are based on maximum speed at 8m Total Dynamic Head. Refer to performance curves on page seventeen (17) for further information.

Model	Flow Rate l/min	Total Head Loss M	RPM	Maximum total head
ESP2300HVS	300	7.2	2850	14 m
	238	4.5	2280	
	120	1.0	1190	

Recommended minimum speed for filtration

This table shows what the minimum speed setting is that we recommend to set the VSD to for filtration purposes and is the speed used to achieve the Star Rating and Energy Efficiency as shown on the Energy Rating Label.

Model	Speed V1 RPM	Flow L/min	Total Head Dynamic	Noise dBA	Star Rating
ESP2300HVS	1190	120	1 m	46	10

The pump has been independently tested to AS 5102.

Filter (V1 Low Speed) - This speed will meet the daily requirements for most private use pools, adjusted to correct pool size, depending on the model of pump used and the RPM it is adjusted too.

Boost (V2 Med Speed) - This speed can be used for the operation of Automatic Pool Cleaners, or to increase the flow for the operation of pool accessories or at times of heavy bather load.

Turbo (V3 High Speed) - Use this speed for backwashing and operation of accessories that may require extra flow for specific functions, such as Spa Jets and Water Features.

Energy Usage Overview

The energy consumed by a pool pump is measured in Watts (W) or kilowatts (kW). The range of EcoStar Variable Speed Pumps display, on the motor interface, the power consumption in Watts. Given this information it is very easy to determine the cost of operating the pump:

Power consumption of pump X cost of electricity = Cost of Pump Operation per Hour

Example: EcoStar Variable Speed Pump operating at 200 W. Cost of electricity = \$0.22 per kWh
200W = 0.2 kW
0.2 kW X \$0.22/kWh = \$0.04 per hour

***NOTE:** The power consumption is greatly effected by the speed of which the pump operates. Lowering the speed of the pump can dramatically reduce the power that is consumed. Below are some of the major benefits of running the pump at lower speeds.

Benefits of operating at low speeds

- Save electricity and money. A reduction in Pump Speed of 50% will reduce power consumption by up to 75%
- Better filtration - the filter can often remove smaller particles when the water moves slower
- Quiet operation, so therefore it is very unlikely to be intrusive to your neighbours
- Reduced Total Dynamic Head - less stress on equipment (e.g. filter) which can extend equipment life

When determining the speed(s) to operate your pump, you must also take into account the minimum requirements for proper sanitation and equipment/water feature functionality.

It is recommended you filter ("turnover") all the water in the pool at least once every 24 hours. Check with local requirements for the minimum turnover rate. Running the pump at lower speed may require running the pump for a longer period of time in order to meet the turnover requirements for proper sanitation.

Equipment such as heaters, skimmers, and chlorinators require minimum flows to operate correctly. Refer to the individual equipment manuals for specific requirements for low flow operation.

After setting the pump speed(s), it is recommended you check all other equipment/water features are functioning as intended. For example, when running at low speed for daily filtration, verify that the water is adequately flowing over the skimmer weirs. Operate the pump at higher speeds for the shorter periods of time needed to operate a heater, water feature, times of increased bather load, ect.

Maintenance

- Clean strainer basket regularly. Do NOT strike the basket to clean it. Inspect the strainer cover gasket regularly and replace it as necessary.
- Hayward pumps have self-lubricating motor bearings and shaft seals. No lubrication is necessary.
- Keep the motor clean. Ensure the air vents and fan are free from obstruction to avoid damage. **Do NOT use water to hose off the motor.**
- Occasionally, shaft seals must be replaced due to wear or damage. Replace with a genuine Hayward seal assembly kit only.
- Do NOT use petroleum based lubricants on gaskets, o-rings, or plastic components. Use silicone based only.

***NOTE** - Tighten the strainer cover lock ring and the union nuts by hand only (**no wrenches**).

Shaft Seal Change Instructions

IMPORTANT SAFETY INSTRUCTIONS PLEASE READ AND FOLLOW ALL INSTRUCTIONS

When servicing electrical equipment, basic safety precautions should always be observed including the following. Failure to follow the instructions may result in injury.

- Disconnect the pump motor power cord from the power outlet before beginning the shaft seal replacment.
- Only qualified personnel should attempt to replace the shaft seal. Contact your local authorized Hayward Dealer or service center if you have any questions.
- Exercise extreme care in handling both the rotating and stationary sections of the two-part replacment seal. Foreign matter or improper handling will easily scratch the graphite and ceramic sealing surfaces.
- See the "Parts Diagram" on page twelve (12) for the pump component locations.

Removing Motor Assembly

1. Remove the four (4) 5/16" x 1.75" hex head bolts (item #6), which hold the motor assembly to the pump/strainer housing (item #4), using a 1/2" AF spanner or socket.
2. Slide the motor assembly out of the pump/strainer housing (item 4), exposing the diffuser (item 9). Remove the three (3) diffuser screws (item #7), and pull the diffuser (item #9) off the seal plate (item #13) to expose the impeller. (item #10).

Removing the Impeller

1. To prevent the motor shaft turning, insert a 6mm Allen Key through the center hole in the fan cowling and into the socket on the end of the motor shaft.
2. Remove the impeller (item #10) by rotating counterclockwise.

Removing the Ceramic Seat

1. Remove the spring seal assembly (item #12) and seal plate (item #13) from the motor by removing the four (4) 3/8" x 1" bolts (item #14) that secure it to the motor, using a 9/16" AF spanner or socket.
2. Press the ceramic seat with rubber cup out of the seal plate (item #13). If tight, use a small screwdriver to tap the seal out from the back side of the seal plate.

⚠ IMPORTANT - Clean all recesses and parts to be reassembled. Inspect gaskets and replace if necessary.

Seal, Impeller, and Diffuser Installation

1. Clean and lightly lubricate the motor shaft seal and recess in the seal plate (item #13) with a dilute solution of non granulated liquid type soap. Gently wipe the polished face of the ceramic seal with a soft, lint free cotton cloth. Lubricate the rubber cup on the ceramic seat and press firmly into the recess of the seal plate (item #13), with the polished ceramic surface facing towards you.
2. Reassemble the motor to the seal plate (item #13) using the four (4) 3/8" x 1" bolts (item #14) by tightening them in a cross pattern and torque to 11.5 N-m. ensure there is equal clearance between the motor shaft and ceramic seat.
3. Gently wipe the black, polished surface of the carbon spring seal assembly (item #12) with a soft, lint free cotton cloth.
4. Press the carbon spring seal assembly (item #12) onto the motor shaft, with black polished surface facing the ceramic seat.
5. Screw the impeller (item #10) onto the motor shaft in a clockwise direction and tighten snugly by holding the motor shaft with the 6mm Allen key as explained earlier.
6. Place the diffuser (item #9) over the impeller (item #10) and onto the seal plate (item #13), aligning the three (3) pins on the diffuser (item #9) with the three (3) holes on the seal plate (item #13). Note: Flat side of diffuser rim will face up. Replace the three (3) diffuser screws (item #7) and torque to 2.3 N-m.
7. Replace the motor assembly into the pump/strainer housing in the reverse order of the removal steps. Ensure the housing gasket (item #11) is lubricated and tighten the housing bolts (item #6) in a cross pattern evenly and to a torque of 21 Newton Meters.

EcoStar Pump Replacement Parts

Parts Diagram

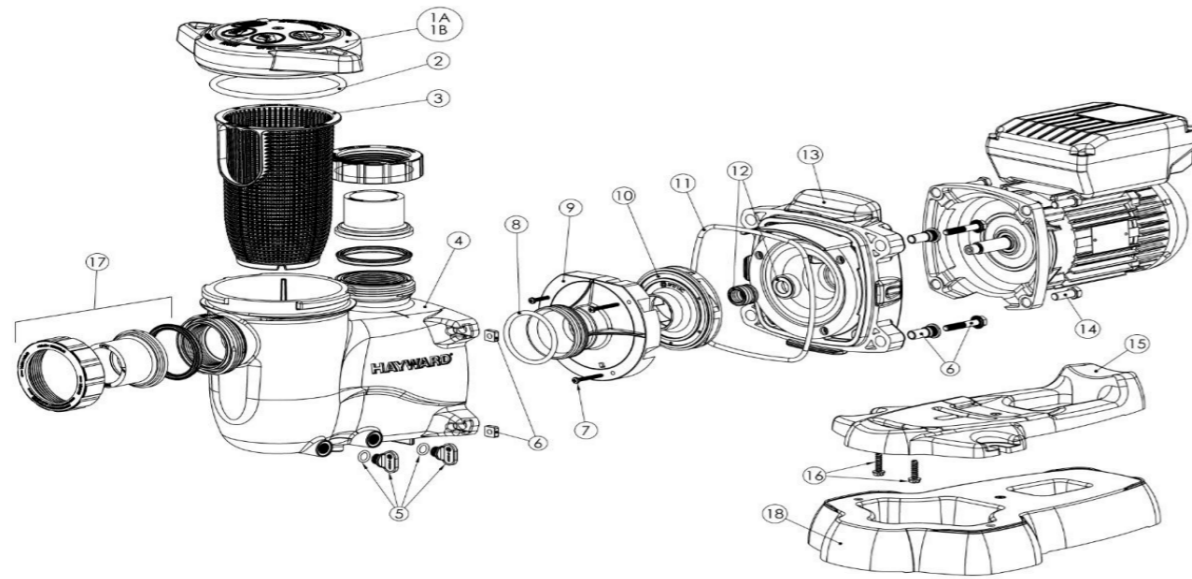

Parts Listing

Ref. No.	Part No.	Description	Qty. Req'd
1	SPX2300DLS	Strainer Cover Kit (Includes Strainer Cover, Lock-Ring, O-Ring)	1
2	SPX2300Z4	Strainer Cover O-Ring	1
3	SPX2300M	Strainer Basket	1
4	SPX2300AA	Pump Strainer Housing with Drain Plugs	1
5	SPX4000FG	Drain Plug with O-Ring	2
6	SPX2700ZPAK	Hardware Pack (Includes 4 Housing Bolts, Seal Plate Spacers & Square Nuts)	1
7	SPX2300Z3PAK3	Diffuser Screw (3Pack)	1
8	SX220Z2	Diffuser O-Ring	1
9	SPX2300B	Diffuser	1
10	SPX2300CVS	Impeller	1
11	GMX600F	Housing O-Ring	1
12	SPX2700SA	Shaft Seal Assembly	1
13	SPX2300E	Seal Plate	1
14	SPX3200Z5PAK4	Motor Bolt (4 Pack)	1
15	SPX2300G	Motor Support with Base Mount Screws	1
16	SPX1600Z52	Motor Support Base Mount Screws (2 Pack)	1
17	SPX2700UNKIT	Union Connector Kit suits 40mm PVC pipe (Inc'd 2 Nuts, Connectors, Gaskets)	1
	SPX3200UNKIT	Union Connector Kit suits 50mm PVC pipe (Inc'd 2 Nuts, Connectors, Gaskets)	1
18	SPX2300GR	Optional Riser Base	1
--	SPX3200UG	Union Gasket - Not shown	2
--	SPX2300VSM	Motor, suit SP2300VS	1
--	SPX0327	"Jack's formula 327 Multilube" Silicone lube for O-Rings - 1 ounce (28 gram) tube	1

Troubleshooting

Motor Will Not Start

1. Ensure the power cord is plugged in and the power is switched on. If the pump still won't start check the availability of power by plugging in another appliance and seeing if it will start.
2. If the pump is controlled via a Chlorinator or Total System Controller, ensure that the controlling device is actually allowing the pump to start.
3. Check for open switches or relays, tripped circuit breakers or blown fuses.
4. Refer to an Authorised Service Agent or another qualified professional.

Motor Cuts Out

Your Hayward pump motor is equipped with **Automatic Thermal Overload Protection**. The motor will automatically shut-off before heat damage buildup can occur due to abnormal operating conditions. The motor will auto-restart when a safe heat level is reached.

Pump Will Not Prime

1. Ensure that the length of time that the 2850 rpm priming cycle runs for is sufficient. This time is factory set to 2 minutes but can be adjusted up to 4 minutes (see page eight (8) for instructions how to change the length of time).
2. Make sure all the suction and discharge valves are open and unobstructed, that the Filter Manual Air Relief Valve is open, and that the pool water level is above all suction openings.
3. Make sure the pump strainer basket is clean.
4. Fill the pump strainer/housing with water to the level of the pump inlet. Ensure that the strainer cover o-ring is clean, seated correctly, and lubricated. Tighten the strainer cover lock ring by hand only.
5. Check for loose unions or damaged union o-rings on the suction side. Replace damaged o-rings and tighten the union nuts by hand only (**no wrenches**).

Low Flow - Generally

1. Check for clogged or restricted strainer basket or suction line. If the suction line is blocked contact a qualified repair professional.
2. The pool piping is under size. Correct the piping size.
3. Check for a plugged or restricted discharge line of the filter or a partially closed valve (high gauge reading). Sand filters - backwash as per manufacturer's instructions; D.E. filters - backwash as per manufacturer's instructions; Cartridge filters - clean or replace the cartridge as per the manufacturer's instructions.
4. An air leak in the suction side plumbing (bubbles issuing from the return fittings). Re-tighten or re-seal threaded suction fittings with Teflon tape. Inspect other plumbing fittings and replace o-rings and tighten as required.
5. Plugged, restricted, or damaged impeller. Replace the impeller, including a new shaft seal assembly.

Noisy Pump

1. Cavitations caused by restricted or undersized suction line, an air leak at any joint, low water level in the pool, and unrestricted discharge return lines. Correct the suction condition or throttle the return lines, if practical. Holding your hand over the return fittings will sometimes prove this, or by putting in a smaller eyeball fitting.
2. Vibration due to improper mounting, ect. Mount the pump on a level surface and secure the pump to the equipment pad.
3. Foreign matter in the pump housing or fan cowling. Loose stones/debris hitting the impeller or the motor colling fan could be the cause. Clean the pump housing and the fan cowling.
4. Motor bearings noisy from normal wear, rust, overheating, or water ingress due to a worn or damaged shaft seal. Contact a qualified repair professional to rectify.

Troubleshooting (continued)

Variable Speed Drive Error Codes

In the case that an internal failure has been detected, the Variable Speed Drive will turn the motor off and display a corresponding error code listed below. As well, the power LED will **FLASH** continuously. If more than one error has been detected the screen will flash between the errors.

The Variable Speed Drive is protected against overload and overheating. If such an error occurs, the controller will automatically try to restart the motor six (6) times. After failing the sixth time to restart the display will show the error message **"Err20"**.

The cause of an error should be investigated and resolved before continuing normal operation of the pump. When the issue has been resolved, press the **RUN/STOP** key to clear the error message.

Error Number	Description	Action	Possible Action
01	Under Voltage. Please check mains supply.	1	1 = Drive Restart 2 = Drive Stop 3 = Drive Stop Special
02	Over Voltage. Please check mains supply.	1	
04	Maximum temperature exceeded Power Module.	3	
05	Over Temperature – Motor.	3	
07	Maximum Current exceeded.	2	
10	Current Measurement Fails Permanently.	2	
20	Overload during Startup Process.	1	
64	Internal Short Circuit Failure.	2	
98	Internal Communication Failure	2	

Action 1 = Drive Restart: - When the error is detected the Error code is to be displayed on the screen for 3seconds before initiating a Drive Restart. If the pump is configured in "RS485 Controlled" mode, it will only start if a speed signal is being sent from the Hayward control system.

Action 2 = Drive Stop: - For any errors where the action is to "Stop" the Drive, the motor is to remain stopped while displaying the error code(s) until the user presses the **RUN/STOP** key to re-set, or the power to the motor is cycled off and back on. If the Drive is stopped due to multiple errors, the display shall scroll between each error displaying each error for 3 seconds whilst blinking on and off every second before moving to the next error code and repeating in a loop until the user presses the **RUN/STOP** key to re-set, or the power to the motor is cycled off and back on

Action 3 = Drive Stop Special: - For "Error 04 Maximum temperature exceeded Power Module", or "Error 05 Over Temperature – Motor", the Drive is to stop the motor and only allow it to restart once both of the over temperature situations have cooled to a pre-determined safe level. The display is to show the fault code and then proceed to the screens "a u t o" and "r s t r t" displaying each for 3 seconds. This will constantly loop around until a favourable re-start condition is sensed by the internal temperature probes.

If the pump is configured in "RS485 Controlled" Mode, it will only start if a speed signal is being sent from the Hayward control system.

Service Mode

When troubleshooting the pump or the pool system it may be useful to run the pump without other program functions like default speed settings and timers. This can be achieved by setting the VSD into Service Mode.

To enter Service Mode remove the power from the pump. Hold down the **DISP/FUNC** button and then apply the power to the pump. "t e s t" will then be displayed on the screen before the motor RPM's while all three speed LED's will be constantly flashing while the pump remains in Service Mode.

In this mode only the RPM of the motor can be changed between 600 rpm and 2850rpm and no speeds will be saved in this mode.

To exit Service Mode simply cycle the power to the pump on and off.

Performance Curves for Hayward ESP2300HVS Pump

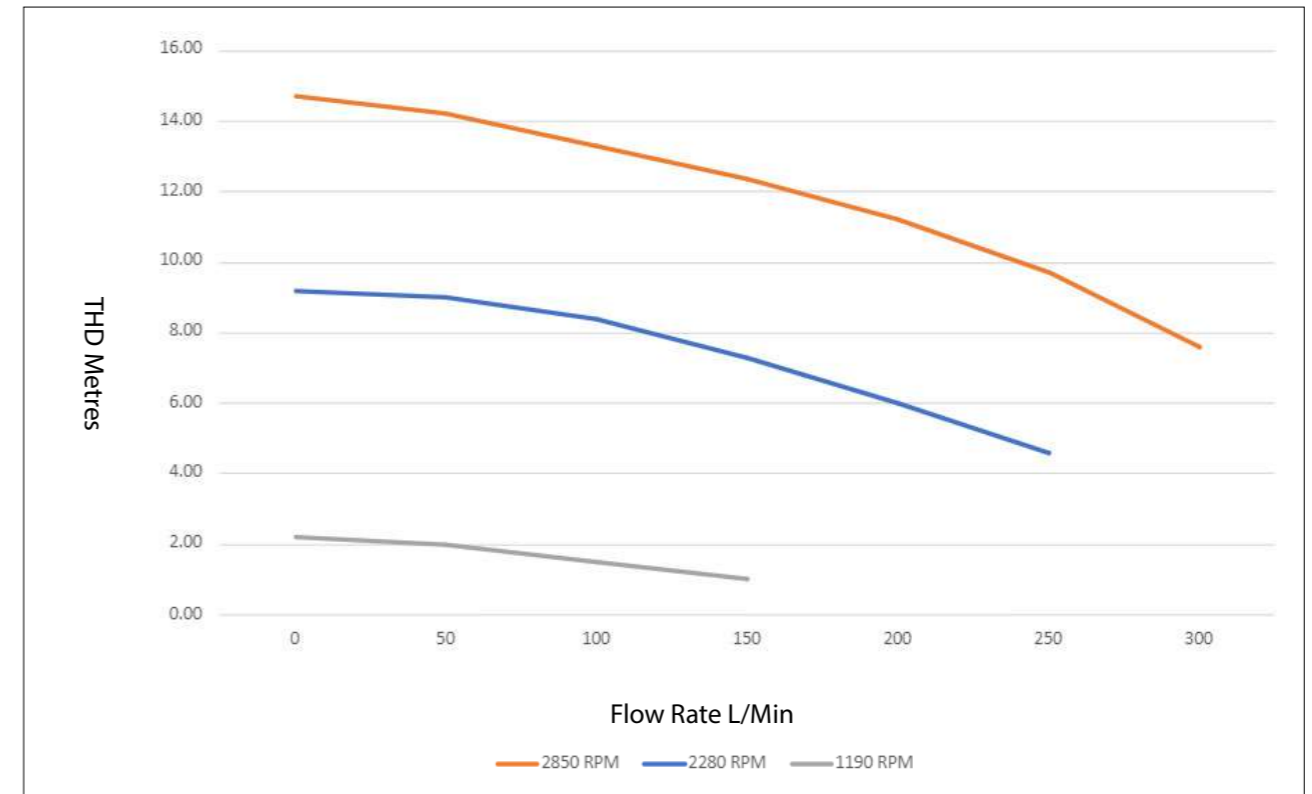

WARRANTY

STANDARD CONDITIONS - Australia and New Zealand Hayward Pool Products (Australia) Pty Ltd (ABN 083 413 414) ("Hayward Pool Products (Australia)") distributes Hayward Pool Products in Australia and New Zealand and provides the following warranties:

STATUTORY RIGHTS

1. The benefits to the consumer under this warranty are in addition to other rights and remedies of the consumer under the laws in relation to the goods and services to which the warranty relates; and
2. Our goods come with guarantees that cannot be excluded under the Australian Consumer Law. You may be entitled to a replacement or refund for a major failure and for compensation for any other loss or damage. You are also entitled to have the goods repaired if the goods fail to be of acceptable quality and the failure does not amount to a major failure.

LIMITED WARRANTY

Hayward Pool Products (Australia) warrants that its products are free from defects in materials and manufacture for 12 months from date of supply by Hayward Pool Products (Australia) plus 90 days to allow for installation and supply (unless otherwise specified). Hayward Pool Products (Australia) will at its discretion, except in the circumstances described below, either repair or replace any product proven to be defective during the warranty period for either materials of manufacture or alternatively pay the cost of repair or replacement within 90 days of the receipt of the defective product, barring unforeseen delays. This warranty is for domestic installation only, is personal to the original purchaser and does not pass to any subsequent purchaser(s).

- To the extent permitted by law, Hayward Pool Products (Australia) will not be liable for products which fail or become defective during the warranty period as a result of freezing, accident, negligence, improper installation, water chemistry, misuse, tampering or lack of care.
- To the extent permitted by law, except as set out in this Warranty, Hayward Pool Products (Australia) excludes all statutory or implied conditions and warranties and any other liability it may have to the Customer (including liability for indirect consequential loss) that may arise under statute or at law including without limitation for breach of contract, in tort (including negligence) or under any other cause of action.
- To the extent permitted by law, except as set out in this Warranty, Hayward Pool Products (Australia) limits its liability under any condition or warranty which cannot be legally excluded in relation to the supply of Goods and Services to:
 1. Repairing the Goods;
 2. Replacing the Goods or supplying equivalent Goods or Services again;
 3. Paying the cost of replacing the Goods or of supplying equivalent Goods or Services again; or
 4. Paying the costs of repairing the Goods.

Claims made for warranty, labour or infield support will not be accepted by Hayward Pool Products unless evidence is provided that installation has been completed in accordance with standard warranty conditions. Please refer to specific program document for details.

WHAT TO DO IF YOU HAVE A WARRANTY CLAIM

The faulty product is to be returned to the place of purchase, or where installed by an approved agent to an authorised warranty agent. No returns will be received directly from end consumers by Hayward Pool Products (Australia). You are responsible for arranging removal of the defective product and arranging installation of the repaired or replacement product, all transportation (and any applicable insurance costs) of transporting the product to the supplier and transporting the replaced or repaired product from the supplier. All returns are subject to Hayward Pool Products (Australia)'s written approval and must be accompanied by either:

1. A Field Inspection Report authorised by the Local Customer Service Manager or Authorised Agent; or
2. A "Return Goods Authorisation" form obtained from Hayward Pool Products (Australia) prior to shipment.

WARRANTY CONTINUED

UNAUTHORISED RETURNS WILL NOT BE ACCEPTED

- All Hayward Pool Products (Australia) warranty parts taken as an across the counter warranty exchange must be held for inspection authorisation has been given by the Local Branch Customer Service Manager to dispose of them. Hayward Pool Products (Australia) reserves the right to provide replacement or credit for any items authorised under this warranty program.
- All claims must be accompanied by a copy of original purchase receipt, clearly stating date of purchase. All serial numbers must place the product within the warranty period or a proof of purchase is required. No claims in respect of the product can be made after the expiration of the warranty period.

Warranty service requests can be faxed to:
Hayward Pool Products (Australia) Pty Ltd.
Fax: 1300 POOLS2 (1300 766571)
 Or submitted to your local Hayward Pool Products (Australia)
 Branch Office.

A standard form is available to request warranty service. We will require:

- Installation contact information including address, daytime telephone numbers, home phone number, email etc.
- Complete model and serial number
- Proof of purchase (if the serial number was manufactured > 1 year ago).
- Evidence that purchase and Installation was completed in one transaction, by the one business or organisation.
- Nature of problem including specific faults and error codes

**To determine if you are eligible for an extended warranty
 register your Hayward pool products
 online today at:
www.hayward-pool.com.au**





Hayward Pool Products (Australia) Pty Ltd.

Melbourne-Sydney-Brisbane-Perth

Email: sales@hayward-pool.com.au Website: www.hayward-pool.com.au

P.O Box 4384, Dandenong South, VIC. 3164

ABN 66 083 413 414

Sales Ph 1300POOLS1 Fx 1300POOLS2



Hayward, TriStar and OmniLogic are registered trademarks of Hayward Industries, Inc.
© 2017 Hayward Industries, Inc.