

HILTI

WSR 18 - A

Operating instructions [en](#)

Mode d'emploi [fr](#)

Manual de instrucciones [es](#)

Manual de instruções [pt](#)

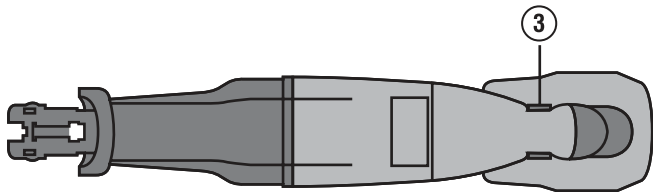
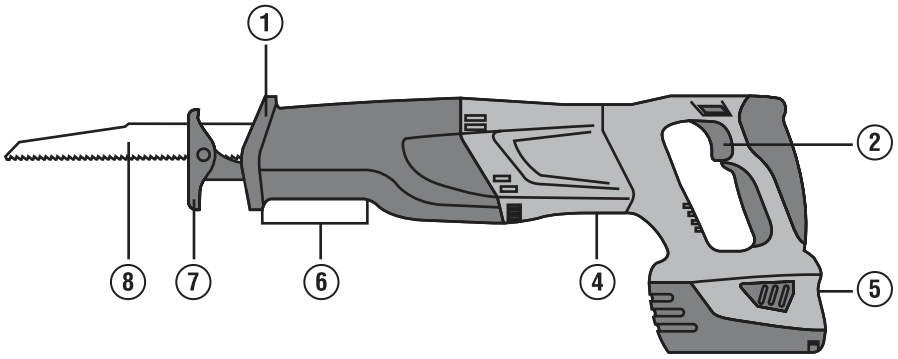

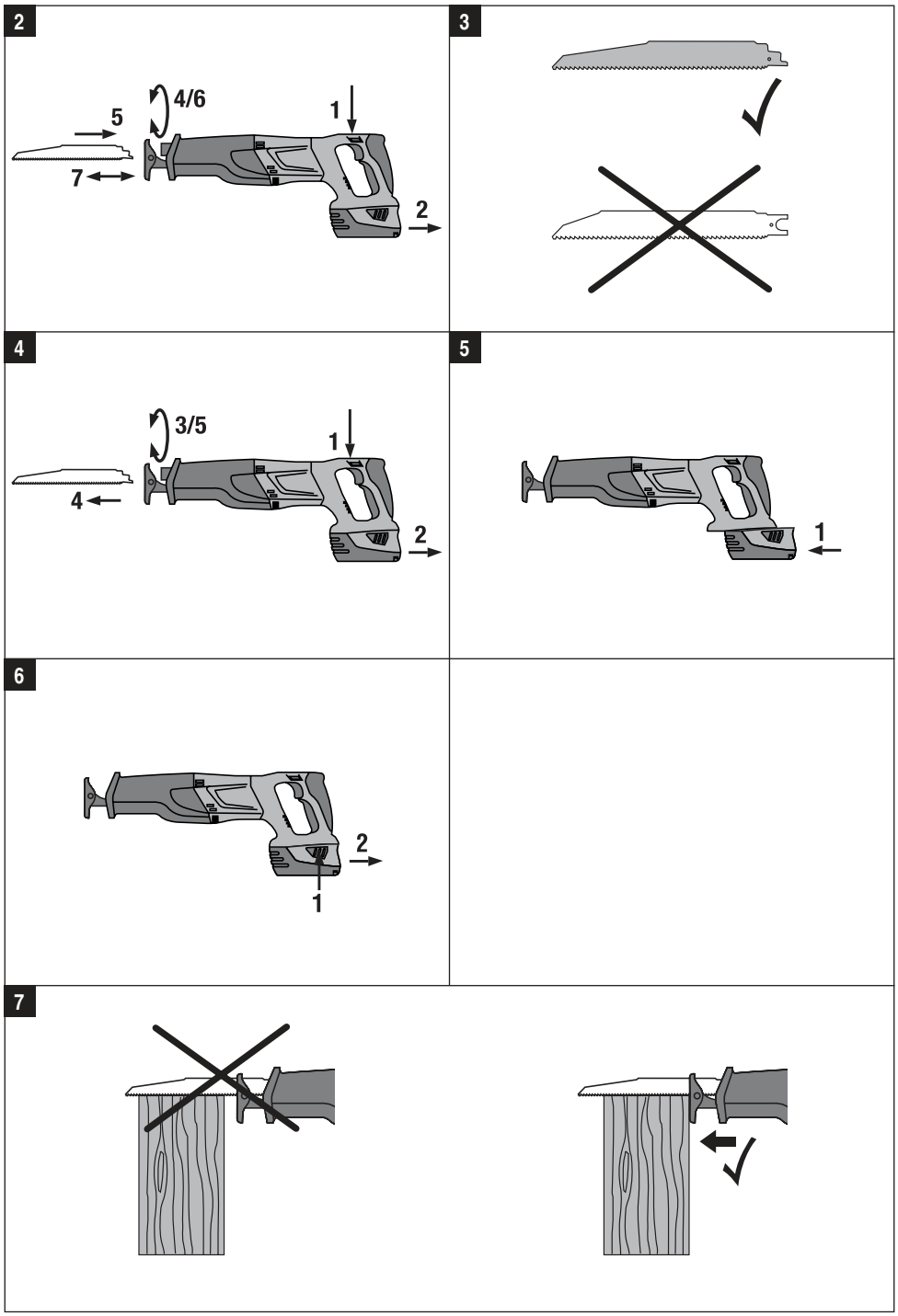

8

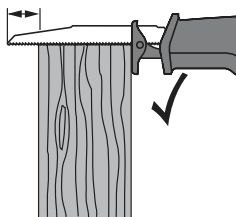
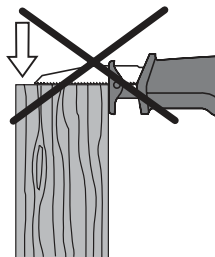

9

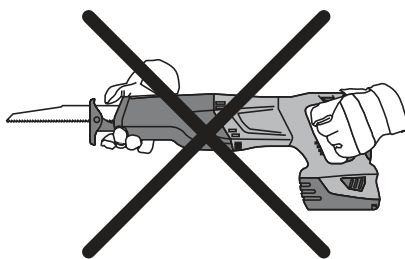
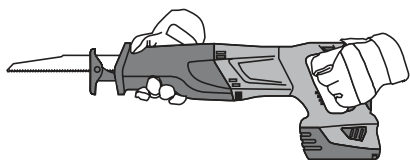

10

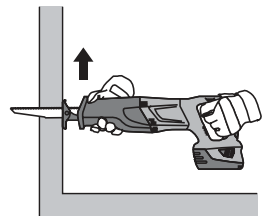
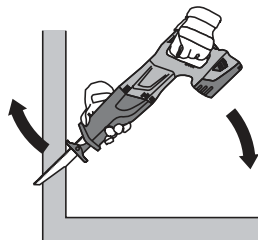
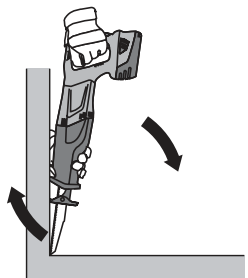
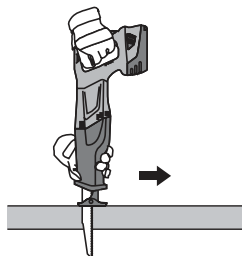
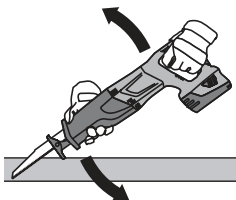
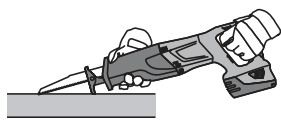

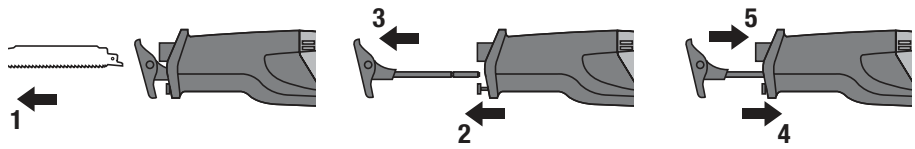

ORIGINAL OPERATING INSTRUCTIONS

WSR 18-A cordless reciprocating saw

en

It is essential that the operating instructions are read before the power tool is operated for the first time.

Always keep these operating instructions together with the power tool.

Ensure that the operating instructions are with the power tool when it is given to other persons.

Contents	Page
1. General information	1
2. Description	2
3. Spare parts	3
4. Accessories	4
5. Technical data	4
6. Safety instructions	4
7. Before use	8
8. Operation	9
9. Care and maintenance	11
10. Troubleshooting	12
11. Disposal	12
12. Manufacturer's warranty - tools	13

1 These numbers refer to the corresponding illustrations. The illustrations can be found on the fold-out cover pages. Keep these pages open while studying the operating instructions.

In these operating instructions, the designation "the power tool" always refers to the WSR 18-A cordless reciprocating saw.

Parts and operating controls **1**

- 1 Blade holder
- 2 Control switch
- 3 Transport lock
- 4 Type identification plate
- 5 Battery
- 6 Forward gripping area (hand guard)
- 7 AVR contact shoe
- 8 Saw blade

1. General information

1.1 Safety notices and their meaning

DANGER

Draws attention to imminent danger that could lead to serious bodily injury or fatality.

WARNING

Draws attention to a potentially dangerous situation that could lead to serious personal injury or fatality.

CAUTION

Draws attention to a potentially dangerous situation that could lead to slight personal injury or damage to the equipment or other property.

NOTE

Draws attention to an instruction or other useful information.

1.2 Explanation of the pictograms and other information

Warning signs



General warning



Warning: electricity



Warning: hot surface



Warning: caustic substances

en

Obligation signs



Wear eye protection



Wear a hard hat



Wear ear protection



Wear protective gloves



Wear breathing protection

Symbols



Volts



Direct current



Strokes per minute



Read the operating instructions before use



Return waste material for recycling.



Stroke rate



Unlocked



Locked

Location of identification data on the power tool

The type designation and serial number can be found on the type identification plate on the machine or tool. Make a note of this data in your operating instructions and always refer to it when making an enquiry to your Hilti representative or service department.

Type: _____

Generation: 01 _____

Serial no.: _____

2. Description

2.1 Use of the product as directed

The WSR 18-A is a cordless reciprocating saw for professional use. It is designed to be used for cutting wood, wood-like materials, metals and plastics. The power tool is suitable for use by right or left-handed persons. An ergonomically designed grip with synthetic rubber covering provides a comfortable, secure hold and makes the power tool less tiring to use.

The power tool is designed for two-handed operation.

Possible fields of use: Rescue services, public authorities, agriculture and forestry, construction sites, workshops, renovation, conversion and new construction, metal construction, timber construction, plumbing, heating and air conditioning system installation in which the types of cutting work listed above are carried out.

Do not use the power tool to cut bricks, concrete, cellular concrete, natural stone or tiles.

Do not use the power tool to cut pipes which still contain liquids.

Do not saw into unknown materials.

The power tool is designed for professional use and may be operated, serviced and maintained only by trained, authorized personnel. This personnel must be informed of any special hazards that may be encountered. The power tool and its ancillary equipment may present hazards when used incorrectly by untrained personnel or when used not as directed.

To avoid the risk of injury, use only genuine Hilti accessories and insert tools.

Working on materials hazardous to the health (e.g. asbestos) is not permissible.

Nationally applicable industrial safety regulations must be observed.

The power tool may be used only in a dry environment.

Do not use the power tool where there is a risk of fire or explosion.

Do not use the battery as a power source for other unspecified appliances.

Observe the information printed in the operating instructions concerning operation, care and maintenance.

Modification of the power tool or tampering with its parts is not permissible.

en

2.2 Switches

Control switch

Safety lock

2.3 Grips

Vibration-absorbing grip

2.4 Items supplied as standard

- 1 Power tool
- 1 Operating instructions
- 1 Hilti toolbox

2.5 Li-ion battery charge status

LEDs light constantly	LEDs blink	Charge status C
LED 1,2,3,4	-	$C \geq 75 \%$
LED 1,2,3	-	$50 \% \leq C < 75 \%$
LED 1,2	-	$25 \% \leq C < 50 \%$
LED 1	-	$10 \% \leq C < 25 \%$
-	LED 1	$C < 10 \%$
-	LED 1	Battery overheated

3. Spare parts

AVR contact shoe 1

7	AVR contact shoe	408847
---	------------------	--------

4. Accessories

Saw blades	with 1/2" connection end	
Charger for Li-ion batteries	C 4/36, C 4/36-ACS or C 4/36-ACS TPS	
Battery	B 18/2.6 Li-ion	
Battery	B 18/1.6 Li-ion	

en

5. Technical data

Right of technical changes reserved.

Power tool	WSR 18-A
Rated voltage (DC voltage)	21.6 V
Weight in accordance with EPTA procedure 01/2003	3.8 kg (8.38 lb)
Dimensions (L x W x H)	492 mm (19.37") x 96 mm (3.78") x 196 mm (7.72")
Stroke rate	0...3,000/min
Stroke	28 mm (1.1")
Blade holder	Keyless, for 1/2" standard blades

Battery	B 18/2.6 Li-ion	B 18/1.6 Li-ion
Rated voltage	21.6 V	21.6 V
Capacity	2.6 Ah	1.6 Ah
Energy capacity	56.16 Wh	34.56 Wh
Weight	0.78 kg (1.72 lb)	0.48 kg (1.06 lb)
Type of cell	Li-ion	Li-ion
Number of cells	12	6
Temperature monitoring during charging	Yes	Yes
Temperature monitoring during discharging	Yes	Yes

6. Safety instructions

NOTE

The safety rules in section 6.1 contain all general safety rules for power tools which, in accordance with the applicable standards, require to be listed in the operating instructions. Accordingly, some of the rules listed may not be relevant to this tool.

6.1 General Power Tool Safety Warnings

- a) **WARNING! Read all safety warnings and instructions.** Failure to follow the warnings and instructions may result in electric shock, fire and/or serious injury. **Save all warnings and instructions.**

tions for future reference. The term "power tool" in the warnings refers to your mains-operated (corded) power tool or battery-operated (cordless) power tool.

6.1.1 Work area safety

- a) **Keep work area clean and well lit.** Cluttered or dark areas invite accidents.
- b) **Do not operate power tools in explosive atmospheres, such as in the presence of flammable liquids, gases or dust.** Power tools create sparks which may ignite the dust or fumes.
- c) **Keep children and bystanders away while operating a power tool.** Distractions can cause you to lose control.

6.1.2 Electrical safety

- a) **Power tool plugs must match the outlet. Never modify the plug in any way. Do not use any adapter plugs with earthed (grounded) power tools.** Unmodified plugs and matching outlets will reduce risk of electric shock.
- b) **Avoid body contact with earthed or grounded surfaces such as pipes, radiators, ranges and refrigerators.** There is an increased risk of electric shock if your body is earthed or grounded.
- c) **Do not expose power tools to rain or wet conditions.** Water entering a power tool will increase the risk of electric shock.
- d) **Do not abuse the cord. Never use the cord for carrying, pulling or unplugging the power tool. Keep cord away from heat, oil, sharp edges or moving parts.** Damaged or entangled cords increase the risk of electric shock.
- e) **When operating a power tool outdoors, use an extension cord suitable for outdoor use.** Use of a cord suitable for outdoor use reduces the risk of electric shock.
- f) **If operating a power tool in a damp location is unavoidable, use a residual current device (RCD) protected supply.** Use of an RCD reduces the risk of electric shock.

6.1.3 Personal safety

- a) **Stay alert, watch what you are doing and use common sense when operating a power tool. Do not use a power tool while you are tired or under the influence of drugs, alcohol or medication.** A moment of inattention while operating power tools may result in serious personal injury.

- b) **Use personal protective equipment. Always wear eye protection.** Protective equipment such as dust mask, non-skid safety shoes, hard hat, or hearing protection used for appropriate conditions will reduce personal injuries.
- c) **Prevent unintentional starting. Ensure the switch is in the off-position before connecting to power source and/or battery pack, picking up or carrying the tool.** Carrying power tools with your finger on the switch or energising power tools that have the switch on invites accidents.
- d) **Remove any adjusting key or wrench before turning the power tool on.** A wrench or a key left attached to a rotating part of the power tool may result in personal injury.
- e) **Do not overreach. Keep proper footing and balance at all times.** This enables better control of the power tool in unexpected situations.
- f) **Dress properly. Do not wear loose clothing or jewellery. Keep your hair, clothing and gloves away from moving parts.** Loose clothes, jewellery or long hair can be caught in moving parts.
- g) **If devices are provided for the connection of dust extraction and collection facilities, ensure these are connected and properly used.** Use of dust collection can reduce dust-related hazards.

6.1.4 Power tool use and care

- a) **Do not force the power tool. Use the correct power tool for your application.** The correct power tool will do the job better and safer at the rate for which it was designed.
- b) **Do not use the power tool if the switch does not turn it on and off.** Any power tool that cannot be controlled with the switch is dangerous and must be repaired.
- c) **Disconnect the plug from the power source and/or the battery pack from the power tool before making any adjustments, changing accessories, or storing power tools.** Such preventive safety measures reduce the risk of starting the power tool accidentally.
- d) **Store idle power tools out of the reach of children and do not allow persons unfamiliar with the power tool or these instructions to operate the power tool.** Power tools are dangerous in the hands of untrained users.
- e) **Maintain power tools. Check for misalignment or binding of moving parts, breakage of parts and any other condition that may affect the**

en

power tool's operation. If damaged, have the power tool repaired before use. Many accidents are caused by poorly maintained power tools.

- f) **Keep cutting tools sharp and clean.** Properly maintained cutting tools with sharp cutting edges are less likely to bind and are easier to control.
- g) **Use the power tool, accessories and tool bits etc. in accordance with these instructions taking into account the working conditions and the work to be performed.** Use of the power tool for operations different from those intended could result in a hazardous situation.

6.1.5 Battery tool use and care

- a) **Recharge only with the charger specified by the manufacturer.** A charger that is suitable for one type of battery pack may create a risk of fire when used with another battery pack.
- b) **Use power tools only with specifically designated battery packs.** Use of any other battery packs may create a risk of injury and fire.
- c) **When battery pack is not in use, keep it away from other metal objects, like paper clips, coins, keys, nails, screws or other small metal objects, that can make a connection from one terminal to another.** Shorting the battery terminals together may cause burns or a fire.
- d) **Under abusive conditions, liquid may be ejected from the battery, avoid contact. If contact accidentally occurs, flush with water. If liquid contacts eyes, additionally seek medical help.** Liquid ejected from the battery may cause irritation or burns.

6.1.6 Service

- a) **Have your power tool serviced by a qualified repair person using only identical replacement parts.** This will ensure that the safety of the power tool is maintained.

6.2 Additional safety instructions

6.2.1 Personal safety

- a) **Wear ear protectors.** Exposure to noise can cause hearing loss.
- b) **Hold power tools by insulated gripping surfaces, when performing an operation where the cutting accessory may contact hidden wiring or its own cord.** Cutting accessory contacting a "live" wire may make exposed metal parts of the power tool "live" and shock the operator.

- c) **Always hold the power tool securely with both hands on the grips provided. Keep the grips dry, clean and free from oil and grease.**
- d) **Breathing protection must be worn if the power tool is used without a dust removal system for work that creates dust.**
- e) **Improve the blood circulation in your fingers by relaxing your hands and exercising your fingers during breaks between working.**
- f) **Operate the power tool only as intended and when it is in faultless condition.**
- g) **Wear protective gloves when changing insert tools as the insert tools get hot during use.**
- h) **Switch the power tool on only after bringing it into the working position.**
- i) **Engage the safety lock before storing or transporting the tool.**
- j) **Avoid unintentional starting. Never carry the power tool with your finger on the control switch. Remove the battery from the power tool during work breaks, before carrying out maintenance, before changing cutting tools and before transporting the power tool.**
- k) **Children must be instructed not to play with the power tool.**
- l) **The power tool is not intended for use by children, by debilitated persons or those who have received no instruction or training.**
- m) **WARNING: Some dust created by grinding, sanding, cutting and drilling contains chemicals known to cause cancer, birth defects, infertility or other reproductive harm; or serious and permanent respiratory or other injury.** Some examples of these chemicals are: lead from lead-based paints, crystalline silica from bricks, concrete and other masonry products and natural stone, arsenic and chromium from chemically-treated lumber. Your risk from these exposures varies, depending on how often you do this type of work. **To reduce exposure to these chemicals, the operator and bystanders should work in a well-ventilated area, work with approved safety equipment, such as respiratory protection appropriate for the type of dust generated, and designed to filter out microscopic particles and direct dust away from the face and body. Avoid prolonged contact with dust. Wear protective clothing and wash exposed areas with soap and water.** Allowing dust to get into your mouth,

eyes, or to remain on your skin may promote absorption of harmful chemicals.

6.2.2 Power tool use and care

- a) **Secure the workpiece. Use clamps or a vice to secure the workpiece.** The workpiece is thus held more securely than by hand and both hands remain free to operate the power tool.
- b) **Check that the insert tools used are compatible with the chuck system and that they are secured in the chuck correctly.**

6.2.3 Special safety instructions for reciprocating saws

- a) **Always guide the power tool away from your body when working with it.**
- b) **Never position your hands ahead of or on the saw blade.**
- c) **Never cut into unknown materials and keep the line of cut above and below the workpiece free of obstacles.** If the saw blade strikes an object it may cause the power tool to kick back.
- d) **Apply moderate pressure and set the power tool to a suitable stroke rate when using the pipe-cutting adapter (accessory), especially when cutting large-diameter pipes.** This will help to prevent the power tool overheating.
- e) **The power tool must be pressed against the workpiece until the AVR contact shoe makes firm contact.** This helps ensure maximum safety and good performance.
- f) **Wear suitable protective clothing to protect you from hot cuttings.**
- g) **Never use the power tool without a fully functional hand guard.**
- h) **Before beginning the work, check the hazard classification of the dust that will be produced. Use an industrial vacuum cleaner with an officially approved protection classification in compliance with locally applicable dust protection regulations.**
- i) **WARNING!**When cutting through pipes, e.g. when carrying out demolition or installation work, check to ensure that the pipes no longer contain liquids and empty them if necessary. When cutting through pipes, hold the power tool above the level of the pipe you are cutting through. The power tool incorporates no protective measures to prevent ingress of water or dampness. Liquids running out of pipes may cause a short circuit in the power tool.

- j) **Do not use the power tool to cut bricks, concrete, cellular concrete, natural stone or tiles.**
- k) **Do not attempt to cut material thicker than the specified max. thickness for which the saw is designed and do not use unsuitable saw blades (reciprocating saw blades of the wrong size or not equipped with a ½" connection end).**
- l) **The transport lock should always be engaged when the power tool is not in use.**

en

6.2.4 Battery tool use and care

- a) **Observe the special instructions applicable to the transport, storage and use of Li-ion batteries.**
- b) **Do not expose batteries to high temperatures or fire.** This presents a risk of explosion.
- c) **Do not disassemble, squash or incinerate batteries and do not subject them to temperatures over 80°C.** A risk of fire, explosion or injury through contact with caustic substances may otherwise result.
- d) **Do not use batteries other than those approved for use with the applicable power tool or appliance.** Use of other batteries or use of the battery for purposes for which it is not intended presents a risk of fire and explosion.
- e) **Do not charge or continue to use damaged batteries (e.g. batteries with cracks, broken parts, bent or pushed-in and/or pulled-out contacts).**
- f) **Use only the Hilti chargers listed under "Accessories".**
- g) **Ensure that the outer surfaces of the battery are clean and dry before inserting it in the corresponding charger. Read the operating instructions for the charger for further information about the charging procedure.**

6.2.5 Electrical safety



Before beginning work, check the working area (e.g. using a metal detector) to ensure that no concealed electric cables or gas and water pipes are present. External metal parts of the power tool may become live, for example, when an electric cable is damaged accidentally. This presents a serious risk of electric shock.

6.2.6 Work area safety

Ensure that the workplace is well ventilated. Exposure to dust at a poorly ventilated workplace may result in damage to the health.

en

6.2.7 Personal protective equipment



The user and any other persons in the vicinity must wear suitable eye protection, a hard hat, ear pro-

tection, protective gloves and breathing protection while the tool is in use.

7. Before use



DANGER

Wear protective gloves when changing insert tools as the insert tools get hot during use.

7.1 Changing the saw blade

CAUTION

Wear protective gloves. The cutting edges of the saw blade teeth are sharp. The cutting edges may present a risk of injury.

7.1.1 Fitting the saw blade 2 3

1. Engage the transport lock.
2. Pull the battery out of the power tool.
3. Check that the connection end of the blade is clean and lightly greased. Clean it and grease it if necessary.
NOTE Use only saw blades equipped with a 1/2" connection end (fig. 3).
4. Turn the blade holder locking sleeve counter-clockwise and hold it in this position.
5. Push the saw blade into the blade holder from the front end of the tool.
6. Release the locking sleeve and allow it to return to its original position with a "click".
7. Grip and pull the saw blade to check that it is locked in position.

7.1.2 Removing the saw blade 4

1. Engage the transport lock.
2. Pull the battery out of the power tool.
3. Turn the blade holder locking sleeve counter-clockwise and hold it in this position.
4. Pull the blade forward out of the blade holder.
5. Release the locking sleeve and allow it to move back to its original position.

7.2 Battery use and care

NOTE

Battery performance drops at low temperatures. Never use the battery until the cells become fully discharged. Change to the second battery as soon as a drop in performance is noticed. Recharge the battery immediately so that it is ready for reuse.

Store the battery in a cool, dry place. Never store the battery where it is exposed to direct sunlight or sources of heat, e.g. on heaters / radiators or behind a motor vehicle windscreen. Batteries that have reached the end of their life must be disposed of safely and correctly to avoid environmental pollution.

7.3 Charging the battery



DANGER

Use only the Hilti batteries and Hilti chargers listed under "Accessories".

7.3.1 Charging a new battery for the first time

A new battery must be charged correctly for the first time before use. This will ensure that the cells form correctly. Incorrect initial charging may have a permanent, negative effect on battery capacity. Please refer to the applicable battery charger's operating instructions for information about initial charging.

7.3.2 Recharging a battery

Ensure that the outer surfaces of the battery are clean and dry before inserting it in the corresponding charger.

Read the operating instructions for the charger for further information about the charging procedure.

Li-ion batteries are ready for use at any time, even when only partly charged. Charging progress is indicated by the LED display (see charger operating instructions).

7.4 Fitting the battery

DANGER

Use only the Hilti batteries and Hilti chargers listed under "Accessories".

CAUTION

Check that the terminals on the battery and in the power tool are free from foreign objects before inserting the battery in the power tool.

1. Push the battery into the power tool from the rear until it is heard to engage with a double click.
2. **CAUTION A falling battery may present a risk of injury to yourself or others.**
Check that the battery is seated securely in the power tool.

en

7.5 Removing the battery

1. Press both battery release buttons.
2. Pull the battery out of the power tool toward the rear.

7.6 Transport and storage of battery packs

Pull the battery pack out of the locked position (working position) and move it into the first latching position (transport position).

If you disconnect a battery pack from the power tool for transport or storage, make sure that the contacts of the battery pack are not short-circuited. Remove loose metal parts such as screws, nails, clamps, loose screw bits, wires or metal swarf from the case, toolbox or transport container, or prevent these parts from coming into contact with the battery packs.

Observe national and international transport regulations when shipping battery packs (transportation by road, rail, sea or air).

8. Operation



NOTE

To ensure good cutting performance and minimize stress on the power tool, use only saw blades that are in good condition.

CAUTION

Do not overload the power tool. It will work more efficiently and more safely within its intended performance range.

CAUTION

Wear protective glasses and a dust mask. The sawing operation swirls up dust and wood chips into the air. The dust and wood chips may be harmful to the eyes and respiratory system.

CAUTION

Dusts are hazardous to the health and can cause respiratory or skin diseases and allergic reactions.

WARNING

Certain dusts are considered to be carcinogenic (cause cancer). These include mineral dust as well as

oak and/or beech wood dust, particularly in conjunction with additional substances used for the treatment of wood (chromate, wood preservatives).

en

CAUTION

Wear ear protectors. The power tool and the sawing operation generate noise. Exposure to noise can cause hearing loss.

CAUTION

Wear protective gloves. The cutting edges of the saw blade teeth are sharp. The cutting edges may present a risk of injury.

CAUTION

Always guide the power tool away from your body when working with it.

CAUTION

Do not lift the power tool away from the workpiece until it has stopped completely.

CAUTION

Lay the power tool down only when it has come to a complete stop.

CAUTION

The saw blade gets hot during intensive use. **Wear protective gloves.** Contact with the saw blade presents a risk of burning injury.

8.1 Safe operation 7 8 9

DANGER

The power tool must be pressed against the workpiece until the AVR contact shoe makes firm contact. This helps ensure maximum safety and good performance.

DANGER

Always use saw blades that project beyond the workpiece over the entire length of the blade stroke. This will help to avoid violent kickback.

WARNING

Always hold the power tool securely with both hands on the grips provided. Never use the power tool without a fully functional hand guard. The blade holder presents a risk of injury.

8.2 Switching on

1. Disengage the transport lock.
2. Press the control switch.

8.3 Switching off

1. Release the control switch.
2. Engage the transport lock.

8.4 Plunge cutting 10

CAUTION

Apply the appropriate safety measures at the rear of the workpiece when plunge sawing. Use only suitable saw blades (length as short as possible).

Use the plunge cutting technique only on soft materials. It takes a little practice to start the cut, without previously drilling a starting hole, by plunging the blade into the surface while the power tool is running. This is possible only with short saw blades. For plunge cutting, the power tool may be used either in the normal position or in the reversed position.

1. Bring the forward edge of the AVR contact shoe into contact with the surface of the material to be cut.
2. Disengage the transport lock.
3. Press the control switch.
4. Press the forward edge of the contact shoe against the surface and begin the plunge action by slowly increasing the angle of attack. To prevent stalling, it is important that the power tool is running before the saw blade is brought into contact with the surface.
5. Once the saw blade has penetrated right through the material, bring the power tool into the normal working position (AVR contact shoe flush with the workpiece) and then continue sawing along the cutting line.

9. Care and maintenance

CAUTION

Before beginning cleaning, remove the battery from the power tool in order to prevent unintentional starting.

9.1 Care and maintenance

Keep the blades clean, especially their connection ends, in order to ensure trouble-free operation of the blade holder.

Keep the blade holder clean.

The power tool has been adequately lubricated during assembly. After a long period of heavy use it is recommended that the power tool is inspected by Hilti. This will help to extend the life of the power tool and avoid unnecessary repair costs.

9.2 Care of the power tool

CAUTION

Keep the power tool, especially its grip surfaces, clean and free from oil and grease. Do not use cleaning agents which contain silicone.

The outer casing of the power tool is made from impact-resistant plastic. Sections of the grip are made from a synthetic rubber material.

Never operate the power tool when the ventilation slots are blocked. Clean the ventilation slots carefully using a dry brush. Do not permit foreign objects to enter the interior of the power tool. Clean the outside of the power tool at regular intervals with a slightly damp cloth. Do not use a spray, steam pressure cleaning equipment or running water for cleaning. This may negatively affect the electrical safety of the power tool.

9.3 Care of the Li-ion battery

Avoid entrance of moisture.

Charge the battery fully before using it for the first time.

In order to achieve maximum battery life, stop discharging the battery as soon as a significant drop in performance is noticed.

NOTE

If use of the power tool continues, further battery discharge will be stopped automatically before the battery cells suffer damage.

Charge the battery with the Hilti charger approved for use with Li-ion batteries.

NOTE

- A conditioning charge (as is required with NiCd or NiMH batteries) is not necessary.

- Interruption of the charging procedure has no negative effect on battery life.

- Charging can be started at any time with no negative effect on battery life. There is no memory effect (as with NiCd or NiMH batteries).

- For best results, batteries should be stored fully charged in a cool dry place. Avoid charging the battery in places subject to high ambient temperatures (e.g. at a window) as this has an adverse effect on battery life and increases the rate of self-discharge.

- If the battery no longer reaches full charge, it may have lost capacity due to aging or overstressing. It is possible to continue working with a battery in this condition but it should be replaced in good time.

9.4 Maintenance

WARNING

Repairs to the electrical section of the power tool may be carried out only by trained electrical specialists.

Check all external parts of the power tool for damage at regular intervals and check that all controls operate faultlessly. Do not operate the power tool if parts are damaged or when the controls do not function faultlessly. If necessary, the power tool should be repaired by Hilti Service.

9.5 Changing the AVR contact shoe

The AVR contact shoe can be changed when required. Before changing the contact shoe, engage the transport lock and remove the battery from the power tool.

1. Engage the transport lock.
2. Remove the battery.
3. Remove the saw blade.
4. Pull the rectangular plastic pin forward. It is located between the two AVR contact shoe guide pins.
5. Pull the AVR contact shoe out.

en

6. Push the rectangular plastic part back into its original position.
7. Grease the AVR contact shoe lightly and insert it fully in the guides.
8. Check to ensure that the contact shoe engages correctly.

9.6 Checking the power tool after care and maintenance

After carrying out care and maintenance work on the power tool, check that all protective and safety devices are fitted and that they function faultlessly.

10. Troubleshooting

Fault	Possible cause	Remedy
The power tool doesn't start.	The control switch is defective.	Have it checked by a trained electrical specialist and replaced if necessary.
	The battery is discharged or fitted incorrectly.	The battery must be heard to engage with a double click or, respectively, needs to be charged.
	The transport lock is engaged.	Disengage the transport lock.
The power tool doesn't achieve full power.	The control switch is not pressed fully.	Press the control switch as far as it will go.
	The battery is discharged.	Change the battery and recharge the discharged battery.
The saw blade can't be removed from the blade holder.	The locking sleeve is not turned as far as it will go.	Turn the locking sleeve as far as it will go and remove the saw blade.

11. Disposal

CAUTION

Improper disposal of the equipment may have serious consequences: The burning of plastic components generates toxic fumes which may present a health hazard. Batteries may explode if damaged or exposed to very high temperatures, causing poisoning, burns, acid burns or environmental pollution. Careless disposal may permit unauthorized and improper use of the equipment. This may result in serious personal injury, injury to third parties and pollution of the environment.

CAUTION

Dispose of defective batteries without delay. Keep them out of reach of children. Do not attempt to open or dismantle batteries and do not dispose of them by incineration.

CAUTION

Dispose of the batteries in accordance with national regulations or return them to Hilti.



Most of the materials from which Hilti power tools or appliances are manufactured can be recycled. The materials must be correctly separated before they can be recycled. In many countries, Hilti has already made arrangements for taking back your old power tools or appliances for recycling. Please ask your Hilti customer service department or Hilti representative for further information.



Batteries

Hilti Li-ion batteries contain lithium-ion cells.

Both you and Hilti bear responsibility for the recycling of worn-out batteries in keeping with environmental protection requirements.

Do not throw worn-out batteries into household waste, a fire or water.

en

12. Manufacturer's warranty - tools

Hilti warrants that the tool supplied is free of defects in material and workmanship. This warranty is valid so long as the tool is operated and handled correctly, cleaned and serviced properly and in accordance with the Hilti Operating Instructions, and the technical system is maintained. This means that only original Hilti consumables, components and spare parts may be used in the tool.

This warranty provides the free-of-charge repair or replacement of defective parts only over the entire lifespan of the tool. Parts requiring repair or replacement as a result of normal wear and tear are not covered by this warranty.

Additional claims are excluded, unless stringent national rules prohibit such exclusion. In particular, Hilti is not obligated for direct, indirect, incidental or consequential damages, losses or expenses in connection with, or by reason of, the use of, or inability to use the tool for any purpose. Implied warranties of merchantability or fitness for a particular purpose are specifically excluded.

For repair or replacement, send the tool or related parts immediately upon discovery of the defect to the address of the local Hilti marketing organization provided.

This constitutes Hilti's entire obligation with regard to warranty and supersedes all prior or contemporaneous comments and oral or written agreements concerning warranties.



Hilti Corporation

LI-9494 Schaan

Tel.: +423 / 234 21 11

Fax: +423 / 234 29 65

www.hilti.com



408058