

HILTI

SCM 18-A

English
Français
Español
Português

en
fr
es
pt



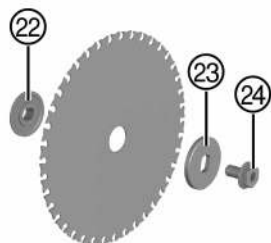
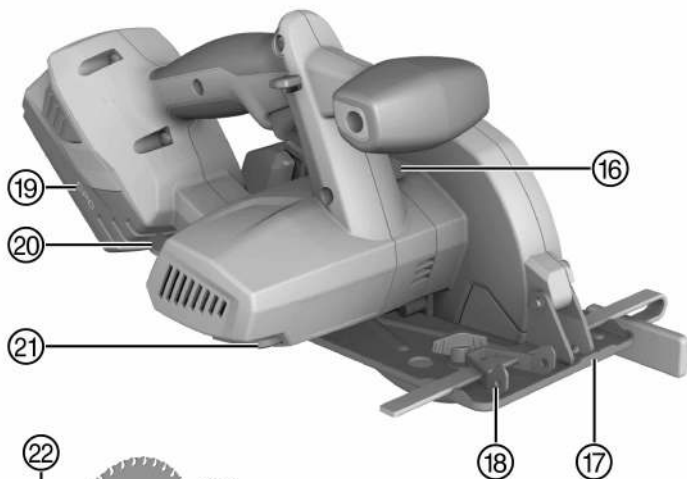
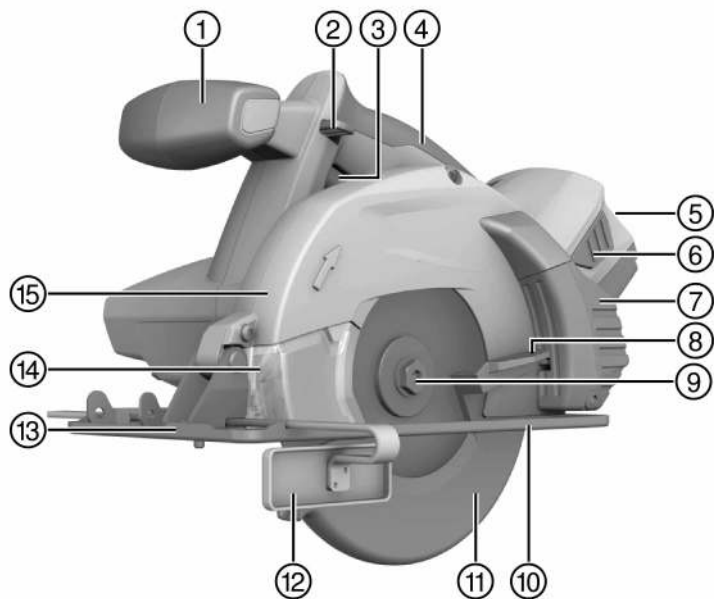

This Product is Certified
Ce produit est homologué
Producto homologado por
Este producto está registrado

2

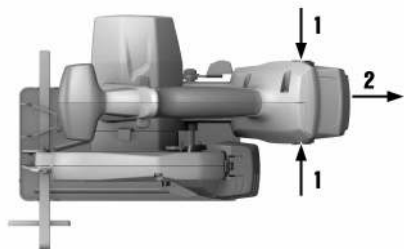

3

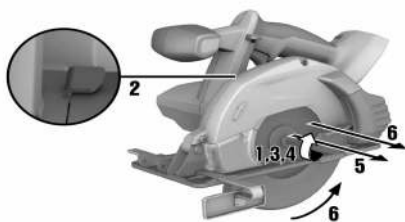

4

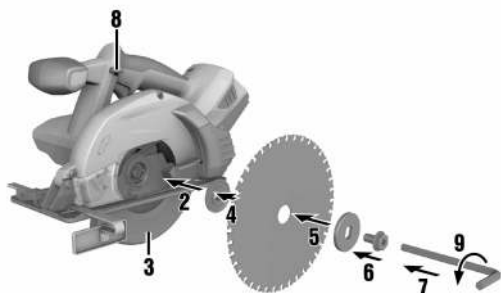

5



6



7

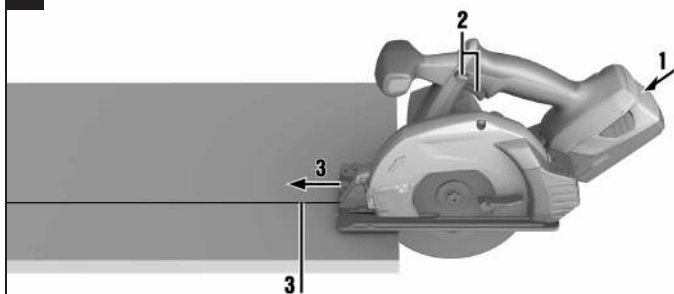

8

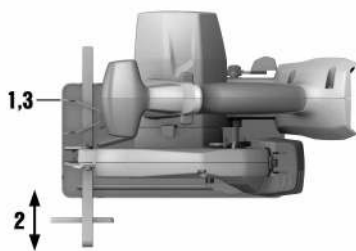

9



SCM 18-A



en	Original operating instructions	1
fr	Mode d'emploi original	12
es	Manual de instrucciones original	24
pt	Manual de instruções original	36

1 Information about the documentation

1.1 Explanation of signs used





1.1.1 Warnings

Warnings alert persons to hazards that occur when handling or using the product. The following signal words are used in combination with a symbol:

	DANGER! Draws attention to imminent danger that will lead to serious personal injury or fatality.
	WARNING! Draws attention to a potentially dangerous situation that could lead to serious personal injury or fatality.
	CAUTION! Draws attention to a potentially dangerous situation that could lead to slight personal injury or damage to the equipment or other property.

1.1.2 Symbols

The following symbols are used:

	Read the operating instructions before use.
	Instructions for use and other useful information
n_0	Rated speed under no load
	Direct current (DC)
/min	Revolutions per minute
RPM	Revolutions per minute
	Saw blade

1.1.3 Illustrations

The illustrations in these operating instructions are intended to convey a basic understanding and may differ from the actual version of the product:

2	These numbers refer to the corresponding illustrations found at the beginning of these operating instructions.
3	The numbering in the illustrations reflects the order of the work steps in the illustration and may deviate from the numbering of work steps in the text.
2	Item reference numbers are used in the overview illustration. In the product overview section, the numbers shown in the legend relate to these item reference numbers.

1.2 About this documentation

- ▶ Read these operating instructions before the product is used or operated for the first time. This is a prerequisite for safe, trouble-free handling and use of the product.
- ▶ Observe the safety instructions and warnings printed in this documentation and on the tool.
- ▶ Always keep the operating instructions with the tool and make sure that the operating instructions are with the tool when it is given to other persons.

We reserve the right to make changes. Errors excepted.

1.3 Product information

Hilti products are designed for professional use and may be operated, serviced and maintained only by trained, authorized personnel. This personnel must be informed of any particular hazards that may be encountered. The product and its ancillary equipment may present hazards when used incorrectly by untrained personnel or when used not as directed.

- Make a note of the designation and serial number printed on the identification plate in the following table.
- ▶ Always quote this information when you contact a Hilti representative or Hilti Service to enquire about the product.

Product information

Type:	
Generation:	01
Serial no.:	

2 Safety

2.1 Safety instructions

The safety rules given in the following section contain all general safety rules for electric tools which, in accordance with the applicable standards, require to be listed in the operating instructions. Accordingly, some of the rules listed may not be relevant to this electric tool.

2.1.1 General power tool safety warnings

WARNING

Read all safety warnings and all instructions. Failure to follow the warnings and instructions may result in electric shock, fire and/or serious injury.

Save all warnings and instructions for future reference.

The term “power tool” in the warnings refers to your mains-operated (corded) power tool or battery-operated (cordless) power tool.

Work area safety

- ▶ **Keep work area clean and well lit.** Cluttered or dark areas invite accidents.
- ▶ **Do not operate power tools in explosive atmospheres, such as in the presence of flammable liquids, gases or dust.** Power tools create sparks which may ignite the dust or fumes.
- ▶ **Keep children and bystanders away while operating a power tool.** Distractions can cause you to lose control.

Electrical safety

- ▶ **Power tool plugs must match the outlet. Never modify the plug in any way. Do not use any adapter plugs with earthed (grounded) power tools.** Unmodified plugs and matching outlets will reduce risk of electric shock.
- ▶ **Avoid body contact with earthed or grounded surfaces, such as pipes, radiators, ranges and refrigerators.** There is an increased risk of electric shock if your body is earthed or grounded.
- ▶ **Do not expose power tools to rain or wet conditions.** Water entering a power tool will increase the risk of electric shock.
- ▶ **Do not abuse the cord. Never use the cord for carrying, pulling or unplugging the power tool. Keep cord away from heat, oil, sharp edges or moving parts.** Damaged or entangled cords increase the risk of electric shock.
- ▶ **When operating a power tool outdoors, use an extension cord suitable for outdoor use.** Use of a cord suitable for outdoor use reduces the risk of electric shock.
- ▶ **If operating a power tool in a damp location is unavoidable, use a residual current device (RCD) protected supply.** Use of an RCD reduces the risk of electric shock.

Personal safety

- ▶ **Stay alert, watch what you are doing and use common sense when operating a power tool. Do not use a power tool while you are tired or under the influence of drugs, alcohol or medication.** A moment of inattention while operating power tools may result in serious personal injury.
- ▶ **Use personal protective equipment. Always wear eye protection.** Protective equipment such as dust mask, non-skid safety shoes, hard hat, or hearing protection used for appropriate conditions will reduce personal injuries.
- ▶ **Prevent unintentional starting. Ensure the switch is in the off-position before connecting to power source and/or battery pack, picking up or carrying the tool.** Carrying power tools with your finger on the switch or energising power tools that have the switch on invites accidents.
- ▶ **Remove any adjusting key or wrench before turning the power tool on.** A wrench or a key left attached to a rotating part of the power tool may result in personal injury.
- ▶ **Do not overreach. Keep proper footing and balance at all times.** This enables better control of the power tool in unexpected situations.
- ▶ **Dress properly. Do not wear loose clothing or jewellery. Keep your hair, clothing and gloves away from moving parts.** Loose clothes, jewellery or long hair can be caught in moving parts.

- ▶ **If devices are provided for the connection of dust extraction and collection facilities, ensure these are connected and properly used.** Use of dust collection can reduce dust-related hazards.

Power tool use and care

- ▶ Do not force the power tool. Use the correct power tool for your application. The correct power tool will do the job better and safer at the rate for which it was designed.
- ▶ **Do not use the power tool if the switch does not turn it on and off.** Any power tool that cannot be controlled with the switch is dangerous and must be repaired.
- ▶ **Disconnect the plug from the power source and/or the battery pack from the power tool before making any adjustments, changing accessories, or storing power tools.** Such preventive safety measures reduce the risk of starting the power tool accidentally.
- ▶ **Store idle power tools out of the reach of children and do not allow persons unfamiliar with the power tool or these instructions to operate the power tool.** Power tools are dangerous in the hands of untrained users.
- ▶ **Maintain power tools. Check for misalignment or binding of moving parts, breakage of parts and any other condition that may affect the power tool's operation. If damaged, have the power tool repaired before use.** Many accidents are caused by poorly maintained power tools.
- ▶ **Keep cutting tools sharp and clean.** Properly maintained cutting tools with sharp cutting edges are less likely to bind and are easier to control.
- ▶ **Use the power tool, accessories and tool bits etc. in accordance with these instructions, taking into account the working conditions and the work to be performed.** Use of the power tool for operations different from those intended could result in a hazardous situation.

Battery tool use and care

- ▶ **Recharge only with the charger specified by the manufacturer.** A charger that is suitable for one type of battery pack may create a risk of fire when used with another battery pack.
- ▶ **Use power tools only with specifically designated battery packs.** Use of any other battery packs may create a risk of injury and fire.
- ▶ **When battery pack is not in use, keep it away from other metal objects, like paper clips, coins, keys, nails, screws or other small metal objects, that can make a connection from one terminal to another.** Shorting the battery terminals together may cause burns or a fire.
- ▶ **Under abusive conditions, liquid may be ejected from the battery; avoid contact. If contact accidentally occurs, flush with water. If liquid contacts eyes, additionally seek medical help.** Liquid ejected from the battery may cause irritation or burns.

Service

- ▶ **Have your power tool serviced by a qualified repair person using only identical replacement parts.** This will ensure that the safety of the power tool is maintained.

2.1.2 Safety instructions for all saws

Cutting procedures

- ▶ **⚠ DANGER: Keep hands away from cutting area and the blade. Keep your second hand on auxiliary handle, or motor housing.** If both hands are holding the saw, they cannot be cut by the blade.
- ▶ **Do not reach underneath the workpiece.** The guard cannot protect you from the blade below the workpiece.
- ▶ **Adjust the cutting depth to the thickness of the workpiece.** Less than a full tooth of the blade teeth should be visible below the workpiece.
- ▶ **Never hold piece being cut in your hands or across your leg. Secure the workpiece to a stable platform.** It is important to support the work properly to minimize body exposure, blade binding, or loss of control.
- ▶ **Hold the power tool by insulated gripping surfaces only, when performing an operation where the cutting tool may contact hidden wiring.** Contact with a "live" wire will also make exposed metal parts of the power tool "live" and could give the operator an electric shock.
- ▶ **When ripping, always use a rip fence or straight edge guide.** This improves the accuracy of cut and reduces the chance of blade binding.
- ▶ **Always use blades with correct size and shape (diamond versus round) of arbour holes.** Blades that do not match the mounting hardware of the saw will run eccentrically, causing loss of control.
- ▶ **Never use damaged or incorrect blade washers or bolt.** The blade washers and bolt were specially designed for your saw, for optimum performance and safety of operation.

Kickback causes and related warnings

- Kickback is a sudden reaction to a pinched, bound or misaligned saw blade, causing an uncontrolled saw to lift up and out of the workpiece toward the operator;
- when the blade is pinched or bound tightly by the kerf closing down, the blade stalls and the motor reaction drives the unit rapidly back toward the operator;
- if the blade becomes twisted or misaligned in the cut, the teeth at the back edge of the blade can dig into the top surface of the wood causing the blade to climb out of the kerf and jump back toward the operator.

Kickback is the result of saw misuse and/or incorrect operating procedures or conditions and can be avoided by taking proper precautions as given below.

- ▶ **Maintain a firm grip with both hands on the saw and position your arms to resist kickback forces. Position your body to either side of the blade, but not in line with the blade.** Kickback could cause the saw to jump backwards, but kickback forces can be controlled by the operator, if proper precautions are taken.
- ▶ **When blade is binding, or when interrupting a cut for any reason, release the trigger and hold the saw motionless in the material until the blade comes to a complete stop. Never attempt to remove the saw from the work or pull the saw backward while the blade is in motion or kickback may occur.** Investigate and take corrective actions to eliminate the cause of blade binding.
- ▶ **When restarting a saw in the workpiece, centre the saw blade in the kerf and check that saw teeth are not engaged into the material.** If saw blade is binding, it may walk up or kickback from the workpiece as the saw is restarted.
- ▶ **Support large panels to minimise the risk of blade pinching and kickback.** Large panels tend to sag under their own weight. Supports must be placed under the panel on both sides, near the line of cut and near the edge of the panel.
- ▶ **Do not use dull or damaged blades.** Unsharpened or improperly set blades produce narrow kerf causing excessive friction, blade binding and kickback.
- ▶ **Blade depth and bevel adjusting locking levers must be tight and secure before making cut.** If blade adjustment shifts while cutting, it may cause binding and kickback.
- ▶ **Use extra caution when sawing into existing walls or other blind areas.** The protruding blade may cut objects that can cause kickback.

Lower guard function

- ▶ **Check lower guard for proper closing before each use. Do not operate the saw if lower guard does not move freely and close instantly. Never clamp or tie the lower guard into the open position.** If saw is accidentally dropped, lower guard may be bent. Raise the lower guard with the retracting handle and make sure it moves freely and does not touch the blade or any other part, in all angles and depths of cut.
- ▶ **Check the operation of the lower guard spring. If the guard and the spring are not operating properly, they must be serviced before use.** Lower guard may operate sluggishly due to damaged parts, gummy deposits, or a build-up of debris.
- ▶ **Lower guard may be retracted manually only for special cuts such as "plunge cuts" and "compound cuts".** Raise lower guard by retracting handle and as soon as blade enters the material, the lower guard must be released. For all other sawing, the lower guard should operate automatically.
- ▶ **Always observe that the lower guard is covering the blade before placing saw down on bench or floor.** An unprotected, coasting blade will cause the saw to walk backwards, cutting whatever is in its path. Be aware of the time it takes for the blade to stop after switch is released.

2.1.3 Additional safety instructions

Personal safety

- ▶ **Modification of the power tool is not permitted.**
- ▶ **Wear ear protectors.** Exposure to noise can cause hearing loss.
- ▶ **Operate the tool only together with the safety devices that belong to it.**
- ▶ **Improve the blood circulation in your fingers by relaxing your hands and exercising your fingers during breaks between working.**
- ▶ **The power tool is not intended for use by inexperienced persons who have received no special training.**
- ▶ **Keep the power tool out of reach of children.**
- ▶ **Do not switch the product on before it is at the workplace.**
- ▶ **Remove the battery before storing or transporting the power tool.**
- ▶ **Do not work overhead with the product.**

- ▶ **Do not attempt to brake the product by applying lateral pressure to the saw blade.**
- ▶ **Do not touch the clamping flange or the clamping screw while the power tool is running.**
- ▶ **Never press the drive spindle lock button while the saw blade is rotating.**
- ▶ **Never direct the power tool toward persons.**
- ▶ **Adjust the pressure applied to the saw blade and the material being cut so that the blade does not stall, possibly causing kickback.**
- ▶ Metal chips / cuttings are sharp and may cause injury. **Keep your clothing closed so that no metal chips or cuttings can find their way into your gloves, footwear or any other part of your clothing.**
- ▶ Pay attention to where the metal cuttings are flying. **The cuttings are hot and could cause a fire or injuries such as burns or cuts.**
- ▶ **Avoid overheating the tips of the saw blade teeth.**
- ▶ **Observe the national health and safety requirements.**
- ▶ **To reduce the risk of injury, use only genuine Hilti accessories and accessory tools.**
- ▶ Dust from materials, such as paint containing lead, some wood species, concrete / masonry / stone containing silica, and minerals as well as metal, may be harmful. Contact with or inhalation of the dust may cause allergic reactions and/or respiratory or other diseases to the operator or bystanders. Certain kinds of dust are classified as carcinogenic such as oak and beech dust, especially in conjunction with additives for wood conditioning (chromate, wood preservative). Material containing asbestos may be handled only by specialists. **Use a dust removal system whenever possible. To achieve a high level of dust collection, use a suitable vacuum cleaner. When indicated, wear a respirator appropriate for the type of dust generated. Ensure that the workplace is well ventilated. Follow national requirements for the materials you want to work with.**

Electrical safety

- ▶ **Before beginning work, check the working area (e.g. using a metal detector) to ensure that no concealed electric cables or gas and water pipes are present.** External metal parts of the power tool may become live, for example, when an electric cable is damaged accidentally. This presents a serious risk of electric shock.

Careful handling and use of batteries

- ▶ **Observe the special guidelines applicable to the transport, storage and use of lithium-ion batteries.**
- ▶ **Do not expose batteries to high temperatures and keep them away from fire.** There is a risk of explosion.
- ▶ **Do not disassemble, crush or incinerate batteries and do not subject them to temperatures over 80°C (176°F).** This presents a risk of fire, explosion or injury through contact with caustic substances.
- ▶ **Never continue to use or attempt to charge damaged batteries, e.g. batteries with cracks, broken parts, bent or pushed-in / pulled-out contacts).**
- ▶ **Do not use the battery as a power source for other unspecified power tools or appliances.**
- ▶ If the battery is too hot to hold, it may be defective. **In this case, place the power tool in a non-flammable location, well away from flammable materials, where it can be kept under observation and allowed to cool down. Contact HiltiService after the battery has cooled down.**

3 Description

3.1 Overview of the product 1

①	Auxiliary grip	⑬	Saw blade position indicator
②	Switch-on interlock release button	⑭	LED / viewing window
③	On/off switch	⑮	Hood
④	Grip	⑯	Drive spindle lockbutton
⑤	Charge state and fault display	⑰	Cutting line indicator
⑥	Battery release button	⑱	Parallel guide (rip fence) clamp
⑦	Chip collector	⑲	Battery
⑧	Pivoting guard operating lever	⑳	Clamping lever for cutting depth adjustment
⑨	Drive spindle	㉑	Hex. socket wrench
⑩	Base plate	㉒	Mounting flange
⑪	Pivoting guard	㉓	Clamping flange
⑫	Rip fence (parallel guide)	㉔	Clamping screw

3.2 Use as directed

The product described is a cordless circular saw. It is designed for cutting metal or materials similar to metal. The use of saw blades not in compliance with the given specification (e.g. diameter, speed of rotation, thickness) or the use of cutting and grinding discs or blades made from high-alloy steel (HSS steel) is not permissible. Do not use the saw to cut wood or wood-like materials, plastics, gypsum board, gypsum fiberboard and composite materials.

- ▶ Use only **Hilti** Li-ion batteries of the B 18 series with this product.
- ▶ Use only the **Hilti** battery chargers from the C4/36 series for these batteries.

3.3 Li-ion battery display

The charge status of the Li-ion battery and malfunctions of the power tool are indicated by the display on the Li-ion battery. The charge status of the Li-ion battery is displayed after pressing one of the two battery release buttons.

Status	Meaning
4 LEDs light.	• Charge status: 75 % to 100 %
3 LEDs light.	• Charge status: 50 % to 75 %
2 LEDs light.	• Charge status: 25 % to 50 %
1 LED lights.	• Charge status: 10 % to 25 %
1 LED blinks, the power tool is ready for use.	• Charge status: < 10 %
1 LED blinks, the power tool is not ready for use.	• The battery has overheated or is completely discharged.
4 LEDs blink, the power tool is not ready for use.	• The power tool is overloaded or has overheated.



Note

Battery charge status cannot be displayed while the control switch is pressed and for up to 5 seconds after releasing the control switch.

If the battery display LEDs blink, please observe the instructions given in the Troubleshooting section.

3.4 Rip fence (parallel guide)

Use of the single arm rip fence allows precise cuts to be made along the edge of the workpiece, or strips of even width to be cut.

The rip fence can be fitted on either side of the base plate.

3.5 Items supplied

Circular saw, saw blade, hex. socket wrench, parallel guide, operating instructions.



Note

To help ensure safe and reliable operation, use only genuine Hilti spare parts and consumables. Spare parts, consumables and accessories approved by Hilti for use with the product can be found at your local **Hilti** Center or online at: www.hilti.com

3.6 Accessories

Clamping flange, mounting flange, clamping screw.

4 Technical data

4.1 Circular saw

	SCM 18-A
Weight	8.8 lb (4.0 kg)
Saw blade diameter	6.3 in ... 6.5 in (160 mm ... 165 mm)

	SCM 18-A
Blade disc thickness	0.05 in (1.2 mm)
Kerf width	0.06 in (1.6 mm)
Saw blade arbor size	0.8 in (20 mm)
Rated speed under no load	3,500 rpm
Maximum cutting depth	2.2 in (57 mm)

5 Operation

5.1 Safe operation



CAUTION

Risk of injury! Inadvertent starting of the product.

- ▶ Remove the battery before making any adjustments to the power tool or before changing accessories.

- ▶ Pull the battery out of the product to the rear.

5.2 Removing the battery 2

- ▶ Press both battery release buttons simultaneously and pull the battery out of the product.

5.3 Removing the saw blade 3



WARNING

Risk of burning injury. A hot accessory tool, clamping flange or clamping screw and the sharp edges of the saw blade present hazards.

- ▶ Wear protective gloves when changing saw blades.

1. Insert the hex. socket wrench in the saw blade clamping screw.
2. Press the spindle lockbutton and hold it in this position.
3. Turn the saw blade clamping screw with the hex. socket wrench until the spindle lockbutton engages fully.
4. Release the clamping screw by turning the hex. socket wrench in the direction of the direction-of-rotation arrow.
5. Remove the clamping screw from the outer clamping flange.
6. Open the pivoting guard by swinging it to the side and then remove the saw blade.



Note

If necessary, the mounting flange can be removed for cleaning.

5.4 Fitting the saw blade 4



Note

Check that the blade to be fitted complies with the technical requirements and that it is well sharpened. A sharp saw blade is an essential requirement for a perfect cut.

1. Clean the mounting flange and the clamping flange.
2. Fit the mounting flange onto the drive spindle the right way round.
3. Open the pivoting guard.
4. Fit the new saw blade.



Note

Observe the direction-of-rotation arrow on the saw blade and on the power tool. They must correspond.

5. Fit the outer clamping flange the right way round.
6. Insert the clamping screw.
7. Insert the hex. socket wrench in the saw blade clamping screw.
8. Press the drive spindle lockbutton.
9. Secure the clamping flange with the clamping screw by turning the hex. socket wrench in the opposite direction to the direction-of-rotation arrow.
 - ◀ The spindle lockbutton engages.
10. Before using the power tool, check that the saw blade is correctly seated and tightened securely.

5.5 Adjusting the cutting depth 5

1. Release the cutting depth adjustment clamping lever.
2. Lift the product in a scissor movement and set the desired cutting depth by closing the clamping lever.

5.6 Inserting the battery 6



WARNING

Risk of injury! Inadvertent starting of the circular saw.

- ▶ Before fitting the battery, check that the circular saw is switched off and that the safety lock is not pressed in (i.e. safety lock is active).



WARNING

Electrical hazard! Risk of short circuiting.

- ▶ Before inserting the battery, check to ensure that the battery terminals and the contacts on the circular saw are free from foreign objects.



WARNING

Risk of injury! Hazard presented by a falling battery.

- ▶ A falling battery may present a risk of injury to yourself and others. Check that the battery is securely seated in the circular saw.

- ▶ Push the battery into the product from the rear as far as it will go and until it is heard to engage with a double click.

5.7 Sawing along a line 7



Note

Secure the workpiece to prevent movement.

Position the workpiece so that the saw blade is free to rotate beneath it.

Check to ensure that the on/off switch on the product is in the "off" position.

Position the forward section of the saw's base plate on the workpiece but do not bring the blade into contact with the workpiece.

1. Fit the battery into the product.
2. While pressing the safety lock, switch the product on by pressing the on/off button.
3. Guide the product along the cutting line on the workpiece at a suitable speed.

5.8 Fitting / adjusting the rip fence (parallel guide) 8

1. Press the clamp together.
2. Push the parallel guide into the base plate as far as desired.
3. Release the clamp when the parallel guide is in the desired position.

5.9 Emptying the chip collector



WARNING

Risk of injury! Hot or sharp metal cuttings / chips present a hazard.

- ▶ Wear protective gloves when emptying the chip collector.

1. Remove the battery from the product.
2. Pull the chip collector away from the tool to the rear.
3. Swing the two halves of the chip collector apart and empty out its contents.
4. Push the chip collector onto the guard until it engages in position.

5.10 Procedure if the chip / dust channel is blocked

1. Remove the battery from the product.
2. Remove the chip collector.
3. Clean the chip / dust channel.



Note

Remove the saw blade if necessary.

4. Check for misalignment or binding of moving parts, breakage of parts and any other condition that may affect operation of the product.

6 Care, maintenance, transport and storage

6.1 Care of the circular saw



WARNING

Electrical hazards. Improper repairs to electrical parts may lead to serious injuries.

- ▶ Electrical parts may be repaired only by trained electrical specialists.

- ▶ **Keep the product, especially its grip surfaces, clean and free from oil and grease. Do not use cleaning agents containing silicone.**
- ▶ Never operate the product when the air vents are blocked. Clean the air vents carefully using a dry brush. Do not allow foreign objects to enter the interior of the product.
- ▶ Clean the outside of the product at regular intervals with a slightly damp cloth. Do not use a spray, steam pressure cleaning equipment or running water for cleaning.



Note

To help ensure safe and reliable operation, use only genuine Hilti spare parts and consumables. Spare parts, consumables and accessories approved by Hilti for use with the product can be found at your local **Hilti Center** or online at: www.hilti.com

6.2 Care of the lithium-ion batteries

- ▶ Keep the battery clean and free from oil and grease.
- ▶ Clean the outer surfaces of the tool with a slightly damp cloth at regular intervals. Do not use cleaning agents containing silicone.
- ▶ To achieve maximum battery lifetime, stop drawing power from the battery as soon as a significant drop in the performance of the power tool is noticed.
- ▶ Charge the batteries using the **Hilti** chargers approved for use with Li-ion batteries.

6.3 Transport and storage



WARNING

Risk of fire! Risk of short circuiting

- ▶ Never store or transport Li-ion batteries in loose, bulk form.



CAUTION

Risk of damage Metal chips / cuttings may find their way into the power tool, battery or charger, thereby presenting a risk of damage or malfunction.

- ▶ Empty the chip collector and clean the product before putting it away in the toolbox or other container for storage or transport.

- ▶ Remove the battery from the product before transport or storage.
- ▶ Observe the nationally and internationally applicable transport regulations when shipping batteries by road, rail, sea or air.



Note

Ideally, the battery should be stored in a fully-charged state in a dry place that is as cool as possible. Storing the battery in places subject to high ambient temperatures (e.g. at a window) has an adverse effect on battery lifetime and increases the rate of self-discharge.

If the battery no longer reaches full charge, it may have lost capacity due to aging or overstraining. It is still possible to work with this battery. You should, however, soon replace the battery with a new one.

6.4 Cleaning the safety guard

1. Remove the saw blade before cleaning the safety guard parts.
2. Clean the safety guard parts carefully with a dry brush.
3. Use a suitable tool to remove deposits or cuttings from the inside surfaces of the safety guard parts.
4. Fit the saw blade.

6.5 Checks after cleaning and maintenance



Note

After cleaning or maintenance, check that all safety devices are fitted and that they function faultlessly.

- ▶ To check the pivoting guard, open the guard fully by moving the guard operating lever.
 - ◄ The pivoting guard must close quickly and completely when the guard operating lever is released.

7 Troubleshooting

- ▶ If the trouble you are experiencing is not listed in this table or you are unable to remedy the problem by yourself, please contact **Hilti** Service.

7.1 The circular saw is not in working order.

Malfunction	Possible cause	Action to be taken
The LEDs indicate nothing.	The battery is not fully inserted.	▶ Push the battery in until it engages with a double click.
	The battery is discharged.	▶ Change the battery and charge the empty battery.
1 LED blinks.	The battery is discharged.	▶ Change the battery and charge the empty battery.
	The battery is too hot or too cold.	▶ Bring the battery to the recommended working temperature.
4 LEDs blink.	The circular saw was overloaded briefly.	▶ Release the control switch and then press it again.
	The overheating prevention cut-out has been activated.	▶ Allow the circular saw to cool down to cool down and clean the air vents.

7.2 The circular saw is in working order.

Trouble or fault	Possible cause	Action to be taken
The on/off button cannot be pressed, i.e. the button is locked.	Not a fault (safety function).	▶ Press the safety lock.
Running speed suddenly drops considerably.	The saw blade jams.	▶ Do not tilt the saw blade.
Chips / cuttings are not transported into the chip collector and thus fall onto the base plate.	The chip collector is full.	▶ Empty the chip collector.
	The chip ejector channel is blocked.	▶ Clean the chip ejector channel.
The saw blade stalls.	Saw advance pressure is too high.	▶ Reduce advance pressure and switch the product back on.
The battery runs down more quickly than usual.	Very low ambient temperature.	▶ Allow the battery to warm up slowly to room temperature.
The battery does not engage with an audible "double click".	The retaining lugs on the battery are dirty.	▶ Clean the retaining lugs and refit the battery.
The circular saw or battery gets very hot.	Electrical fault.	▶ Switch off the circular saw immediately. Remove the battery and keep it under observation. Allow it to cool down. Contact Hilti service.
	The product is overloaded (application limits exceeded).	▶ Pay attention to the power and performance rating of the product before using it, i.e. check its suitability for the job on hand. See "Technical data" section.

8 Disposal



WARNING

Risk of injury. Hazards presented by improper disposal.

- ▶ Improper disposal of the equipment may have the following consequences: The burning of plastic components generates toxic fumes which may present a health hazard. Batteries may explode if damaged or exposed to very high temperatures, causing poisoning, burns, acid burns or environmental pollution. Careless disposal may permit unauthorized and improper use of the equipment. This may result in serious personal injury, injury to third parties and pollution of the environment.
- ▶ Dispose of defective batteries right away. Keep them out of reach of children. Do not disassemble or incinerate the batteries.
- ▶ Batteries that have reached the end of their life must be disposed of in accordance with national regulations or returned to **Hilti**.

 Most of the materials from which **Hilti** tools and appliances are manufactured can be recycled. The materials must be correctly separated before they can be recycled. In many countries, your old tools, machines or appliances can be returned to **Hilti** for recycling. Ask **Hilti** Service or your Hilti representative for further information.

9 Manufacturer's warranty

- ▶ Please contact your local **Hilti** representative if you have questions about the warranty conditions.

HILTI

Hilti Corporation

LI-9494 Schaan

Tel.: +423/234 21 11

Fax: +423/234 29 65

www.hilti.com

Hilti = registered trademark of Hilti Corp., Schaan
Pos. 3 | 20150801



2019523