

LIBRETTO ISTRUZIONI

IT

INSTRUCTIONS BOOKLET

GB

NOTICE D'EMPLOI ET ENTRETIEN

FR

mod.

Securing the cooker to the wall

Drill two holes in the wall approximately 70 cm above the lower edge of the sides of the cooker (as shown in fig. A position **F**, so that they are concealed by the cooker itself (see fig. B).

Insert part **R** (rawlplug) into holes **F** and screw hook **G** into part **R** (fig. C).

Secure the chain to hook **G** as shown in fig. D position **C**.

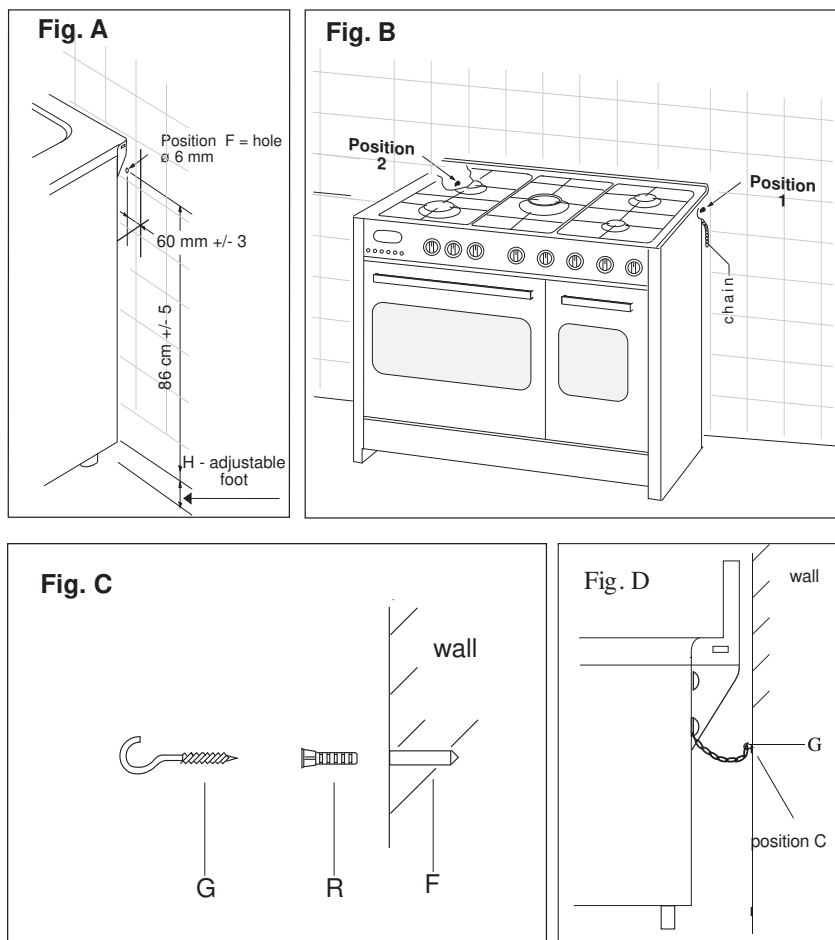

GENERAL INFORMATION DESTINED TO THE END USER

ENVIRONMENT PROTECTION

Packing disposal 

Sort packing into different materials (cardboard, polystyrene etc.) and dispose of them in accordance with local waste disposal laws.

This appliance complies with the following European Directives:

- 73/23/EEC regarding "Low Voltage".
- 89/336/EEC regarding "Electromagnetic Disturbances".
- 90/396/EEC regarding "Gas appliances"
- 89/109/EEC regarding "Materials in contact with food"
- Moreover the above mentioned Directives comply with Directive 93/68/EEC.
- This household appliance has been designed for cooking and it must therefore be used for this purpose only.

DEAR CUSTOMER,

- Carefully read these instructions before using the appliance and keep them for future consultation.
- Keep potentially hazardous packaging (plastic bags, polystyrene etc.) out of the reach of children.

CLIENT ASSISTANCE SERVICE

Before calling Technical Service

In case of malfunction, we advise you to:

- check that the plug is correctly inserted into the electricity supply;
- check that the gas is flowing normally.

If the cause of malfunction is not identified:

turn the apparatus off, do not tamper with it and call Technical Service.

Before leaving the factory, this appliance has been tested and set up by skilled personal, in order to give the best performance results.

Each reparation or set up that could be necessary afterwards, must be carried out with a great care and attention.

For this reason, we recommend you to keep always in touch with the Sales Centre or with our nearer After Sales Service. Specify always the kind of problem and the model of your appliance.

RECCOMANDATIONS AND PRECAUTIONS

ATTENTION:

- Before using the appliance, do not forget to remove the plastic films protecting some parts of the appliance (facia-panel, parts in stainless steel, etc.)
- Do not use the appliance as a space heater.
- When the appliance is not in use, we recommend *to disconnect the current and to close the gas general tap.*

IN CASE OF FIRE:

- In case of fire, close *immediately the main valve of the gas pipe line, disconnect current* and never pour water on firing oil in any case.
- Do not store flammable products or aerosol containers near the burners, and do not vaporize them near lighted burners.

FOR YOUR SAFETY AND THE ONE OF YOUR CHILDREN.

- Do not store items that are attractive to children above or near the appliance.
- Keep children well away from the appliance: do not forget that some parts of the appliance or of the pans become very hot and dangerous during use, and also for all the time necessary to cool down.
- In order to avoid any unintentional fall down, pan handles should be turned to the back of the cooker, not out to the room or over adjacent burners.
- When cooking, do not use clothes with large flaving and flammable sleeves; in case of firing you can suffer very serious harms.

WARNING - OVEN:

When the oven or the grill are in use, accessible parts can become very hot; it is necessary to keep children well away from the appliance.

- Never cook food on the lower wall of the oven.
- In case of careless use, in proximity of the oven door hinges, there is hurt danger.
- Do not let children sit down or play with the oven door. Do not use the drop down door as a stool to reach above cabinets.

WARMING CABINET

You must not place inflammable materials or plastic utensils in the warming cabinet (placed below the oven).

WORK-TOP USE

USING GAS BURNERS

The following symbols are on the control panel next to each knob:

- Black circle ● gas off
- Large flame 🔥 maximum setting
- Small flame 🔥 minimum setting

The minimum position is at the end of the anti-clockwise rotation of the knob. All operation positions must be chosen between the positions of max. and min., never choose them between max. and off.

The gas burners are equipped with a thermocouple safety device to prevent gas from leaking out. This device ensures that the gas supply is shut off if the flame on the gas burner is extinguished while the burner is in use.

Igniting the gas burners

Proceed as follows to light one of the burners

- Turn the appropriate knob anti-clockwise to the large flame symbol;
 - Press in the knob firmly to activate the automatic gas igniter ★ ;
 - Hold the knob in for around 10 seconds once the flame has ignited to allow the thermocouple to heat up.
 - Then release the control knob and ensure that the gas has ignited properly. If it has not, repeat the process.
- In case there is no electric current, the burner can also be lighted using a match.

ENERGY SAVING TIPS

- The diameter of the pan bottom should be the same as that of the burner. The burner flame must never come out from the pans diameter.
- Use flat-bottomed pans only.
- Whenever possible, keep a lid on the pan while cooking. You will not need as much heat.
- Cook vegetables, potatoes, etc. with as little water as possible to reduce cooking times.

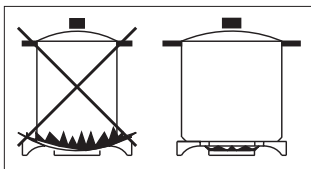

BURNERS	PANS	
	Ø min.	Ø max
RAPIDE	180 mm	220 mm
SEMIRAPIDE	120 mm	200 mm
TRIPLE CROWN	220 mm	260 mm

USE OF THE ELECTRIC OVEN

FIRST PART

The first time the oven is used, it may give off acrid smells, caused by the first heating of isolating panels glue surrounding the oven (it is necessary to heat up the oven at the maximum temperature for about 30-40 minutes with closed door). It is something normal, and in case it will occur, wait for the smoke to stop before introducing the food into the oven.

The oven is fitted with: a rod shelf for cooking food contained in oven dishes or placed directly on the rod shelf itself, a drip-tray for cooking sweets, biscuits, pizzas, etc., or for collecting juices and fats from food cooked directly on the rod shelf.

Note: The following tables give the main points for cooking some of the most important dishes. The cooking times recommended in these tables are approximate. After a few tries, we are sure that you will be able to adjust the times to get the results you want.

Conventional cooking table TAB.B

Dish	Temp. °C.	Minutes
Fish	180-240	acc. to size
Meat		
Roast ox	250	30 per kg.
Roast veal	200-220	30 per kg.
Chicken	200-240	50 about
Duck and goose	220	acc. to weight
Leg of mutton	250	30 per kg.
Roast pork	250	60 per kg.
Soufflets	200	60 per kg.
Sweets (pastries)		
Tea-cake	160	50-60
Sponge finger	160	30-50
Shortcrust pastry	200	15
Puff pastry	250	15
Fruit flan	200-220	30
Meringues	100	60
Quiches, etc.	220	30
4 quarters	120-140	60
Buns	160-180	45

Fan oven cooking table TAB.C.

Dish	Temp. °C.	Minutes	Weight kg.
Firs courses			
Lasagne	200-220	20-25	0,5
Oven pasta	200-220	25-30	0,5
Creole rice	200-230	20-25	0,5
Pizza	210-230	30-45	0,5
Meat			
Roast veal	160-180	65-90	1-1,2
Roast pork	160-170	70-100	1-1,2
Roast ox	170-190	40-60	1-1,2
Roast beef joint	170-180	65-90	1-1,2
Roast fillet beef (rare)	180-190	40-45	1-1,5
Roast lamb	140-160	100-130	1,5
Roast chicken	180	70-90	1-1,2
Roast duck	170-180	100-160	1,5-2
Roast goose	160-180	120-160	3-3,5
Roast turkey	160-170	160-240	5 approx.
Roast rabbit	160-170	80-100	2 approx.
Roast hare	170-180	30-50	2 approx.
Fish	160-180	acc. to weight	
Sweets (pastries)			
Fruit flan	180-200	40-50	
Plain sandwich cake	160-180	35-45	
Sponge sandwich cake	200-220	40-45	
Sponge cake	200-230	25-35	
Currant cake	230-250	30-40	
Buns	170-180	40-60	
Strudel	160	25-35	
Cream slices	180-200	20-30	
Apple fritters	180-200	18-25	
Sponge finger pudding	170-180	30-40	
Sponge finder biscuits	150-180	50-60	
Toasted sandwiches	230-250	7	
Bread	200-220	40	

1 – NATURAL CONVECTION OVENS

The oven is fitted with:

- a lower heating element;
- an upper heating element.

It is possible to select the desired temperature into the oven by turning clockwise the thermostat knob and depending on the models, one or more functions:

- Oven off
- 💡 Oven light

60 ÷ max Upper + lower heating element on

- ∩ Upper heating element on
- ∪ Lower heating element on
- ⚡ Grill element on + turnspit

Note:

Always use the oven with the oven door closed.

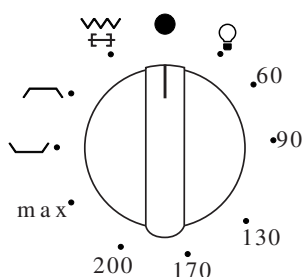

2 – MULTIFUNCTIONAL OVEN

Ovens with separate thermostat and commutator.

The oven is fitted with:

- a lower heating element;
- an upper heating element;
- a circular heating element surrounding the fan.

N.B.: Always set the temperature on the thermostat knob before selecting any of the functions.

Oven thermostat knob

To obtain an oven temperature between 50°C and MAX°C, turn the knob clockwise.

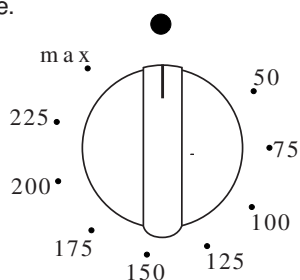

Oven commutator knob

Depending on the type of oven, it is possible to select one of the following functions turning the commutator knob clockwise.

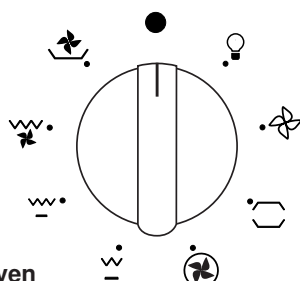

Use of the oven

Note:

Always use the oven with the oven door closed.

When the functions ∩ ∪ are used, place the thermostat knob between 180 ÷ 200°C as maximum temperature.

ATTENTION:

The temperature shown on the control panel corresponds to the temperature in the oven centre only when the functions selected are ☐ or 🌀.



When you turn the control knob to this position, the light will be on for all the following operations.



Defrosting with fan

The air at ambient temperature is distributed inside the oven for defrosting food very quickly and without proteins adulterations.



Natural convection

Both the lower and upper heating elements operate together. This is the traditional cooking, very good for roasting joints, ideal for biscuits, baked apples and crisping food. You obtain very good results when cooking on a shelf adjusting the temperature between 50 and MAX°C.



Fan oven

Both the fan and the circular heating element operate together. The hot air adjustable between 50 and MAX°C is evenly distributed inside the oven. This is ideal for cooking several types of food (meat, fish) at the same time without affecting taste and smell. It is indicated for delicate pastries.



Medium grill

It is indicated for grilling and gratinating small quantities of traditional food.

The thermostat knob must be placed on the maximum position.



Total grill

It is indicated for grilling and gratinating traditional food. The thermostat knob must be placed between 180 ÷ 200°C position as maximum temperature.



Fan assisted total grill

The air which is heated by the grill heating element is circulated by the fan which distributes the heat on the food. The fan assisted grill replaces perfectly the turnspit. You can obtain very good results also with large quantities of poultry, sausage, red meat. The thermostat knob must be placed between 180 ÷ 200°C position as maximum temperature.



Air forced lower heating element

The air which is heated by the lower heating element is circulated by the fan which distributes the heat on the food. This function can be used to sterilize food. This function can be used between 50 and MAX°C

Note:

All the functions mentioned above switch the oven internal light on. A warning light on the control panel will stay lit until the temperature is reached; after it will light up intermittently.

USE OF THE GRILL

Install the grid on the third shelf from the oven bottom, at about 12 cm from the surface.

The user can change the shelves, depending on his personal wishes and on the different food.

Heat the oven 5 minutes before introducing the food.

TURNSPIT

In order to make the electric heating element work follow the instructions described in paragraph 1 page 5 position , this selection puts into function the turnspit as well.

USE OF THE TURNSPIT

For utilization of the turnspit follow the instructions described.

- Put the food in spit **L** (see fig. 3), paying attention to block it within the two forks **F** and to balance it, in order to avoid any unnecessary effort in motor **R** (fig 3).
- Put the spit on support **G**, after having put its opposite end into hole **P** of motor **R**.
- Place the drip-tray with a little water under the spit.
- To remove the spit, operate in the opposite direction using knob **A** and protecting glove in isolating wool (see fig. 3).

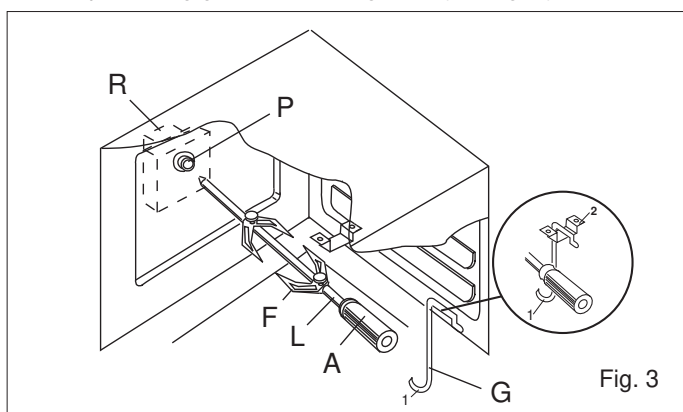

Fig. 3

INSTRUCTIONS FOR USE OF CONTROL DEVICES

“LED” PROGRAMMER (Fig. 4)

Features

24 hours clock with automatic programme and minutes counter.

Functions

Cooking time, cooking end time, manual position, clock, minutes counter, times to be set up to 23 hours 59 minutes.

Display

4-figures, 7-segments display for cooking times and time of day.

Cooking time and manual function = saucepan symbol

Automatic function = AUTO

Minutes counter = bell symbol

The symbols light up when the corresponding functions are selected.

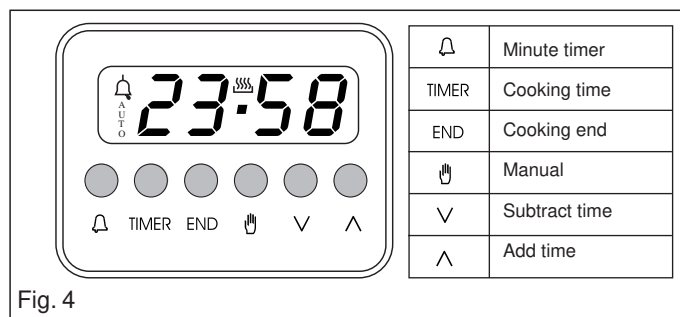

Fig. 4

Setting

To set, press and release the desired function, and within 5 seconds set the time with ∇ and ∧ buttons.

∇ and ∧ buttons.

The + and - buttons increase or decrease the time at a speed depending on how long the button is pressed.

Setting the time

Press any two buttons manual at the same time, and ∇ or ∧ button to set the desired time. This deletes any previously set programme. The contacts are switched off.

Manual use

By pressing the manual button the relay contacts switch on, the AUTO symbol switches off and the saucepan symbol lights up. Manual operation can only be enabled after the automatic programme is over or it has been cancelled.

Automatic use

Press the cooking time or end time button to switch automatically from the manual to the automatic function.

Semi-automatic use with cooking time setting

Press the cooking time button and set the desired time with ∇ or ∧. The AUTO and cooking time symbols light up continuously. The relay switches on immediately. When the cooking end time corresponds to the time of day, the relay and cooking time symbol switch off, the sound signal rings and the AUTO symbol flashes.

Semi-automatic use with end time setting

Press the end time button. The time of day appears on the display. Set the cooking end time with ∧ button. The AUTO and cooking time symbols light up continuously. The relay contacts switch on. When the cooking end time corresponds to the time of day, the relay and the cooking time symbol switch off. When the cooking time is up, the AUTO symbol flashes, the sound signal rings and both the relay and the cooking time button switch off.

Automatic use with cooking time and end time setting

Press the cooking time button and select the length of the cooking time with ∇ or ∧ button. The AUTO and cooking time symbols light up continuously. The relay switches on. By pressing the cooking end time button the next cooking end time appears on the display. Set the cooking end time with ∧ button. The relay and the cooking time symbol switch off.

The symbol lights up again when the time of day corresponds to the cooking start time. When the cooking time is up, the AUTO symbol flashes, the sound signal rings, the cooking time symbol and the relay switch off.

Minutes counter

Press the minutes counter button and set the cooking time with ∇ or ∧ button.

The bell symbol lights up when the minutes counter is operating. When the set time is up, the sound signal rings and the bell symbol switches off.

Sound signal

The sound signal starts at the end of a programme or of the minutes counter function and it lasts for 15 minutes.

To stop it, push any one of the functions buttons.

Start programme and check

The programme starts 4 seconds after it has been set.

The programme can be checked at any time by pressing the corresponding button.

Setting error

A setting error is made if the time of day on the clock falls within the cooking start and end times.

To correct the setting error, change the cooking time or cooking end time.

The relays switch off when a setting error is made.

Cancelling a setting

To cancel a setting, press the cooking time button and then press the - button until 00 00 appears on the display.

A set programme will automatically cancel on completion.

CARE AND MAINTENANCE

Before cleaning the appliance, *disconnect the gas general tap and unplug the appliance or disconnect power at the main circuit breaker of the electrical system.*

Do not clean the appliance surfaces when still hot.

IMPORTANT

Periodically check the external gas connection hole and replace it when it shows any sign of deterioration. Do not attempt to repair the gas hose under any circumstances.

ENAMELLED SURFACES

Clean with a damp sponge using soap and water.

Grease can be easily removed using hot water or a specific cleansing agent for enamelled surfaces. Do not use abrasive cleansers.

Do not leave any acid or alkaline substances (lemon juice, vinegar, salt, etc.) on the enamel.

Clean the parts in stainless steel with specific cleansers for stainless steel surfaces.

These detergents must be applied using a soft cloth.

GRIDS AND BURNERS

To clean the work-top burners, remove them by pulling upwards and soak them for about 10 minutes in hot water with a little detergent. After having cleaned and washed them, wipe them carefully.

Make sure that no burner hole is clogged.

Clean the burners once a week or more frequently if necessary. **MAKE SURE YOU HAVE ASSEMBLED THE BURNERS IN A RIGHT WAY.**

OVEN DOOR

For some models, the oven door can be disassembled in the following way:

hinges A are provided, for this purpose, with two movable jumpers B; these, once hooked to the hinges slots C, when the door is completely opened, block them. After that lift the door outward carrying out the two movements shown in the picture. To do that, operate on the door sides next to the hinges. In order to re-assemble the door, introduce the hinges in their relevant slots. Before closing the door, do not forget to remove the movable jumpers B.

Attention, in proximity of the oven door hinges, there is hurt danger.

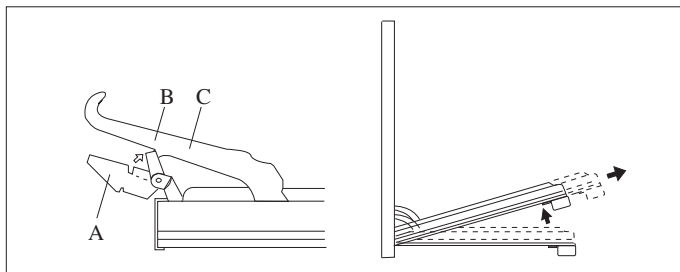
**OVEN**

Clean the enamelled parts with a damp sponge using soap and water. Grease can be easily removed using hot water or a specific cleansing agent for enamelled surfaces.

Do not use abrasive cleansers.

INSTRUCTIONS DESTINED TO THE USER

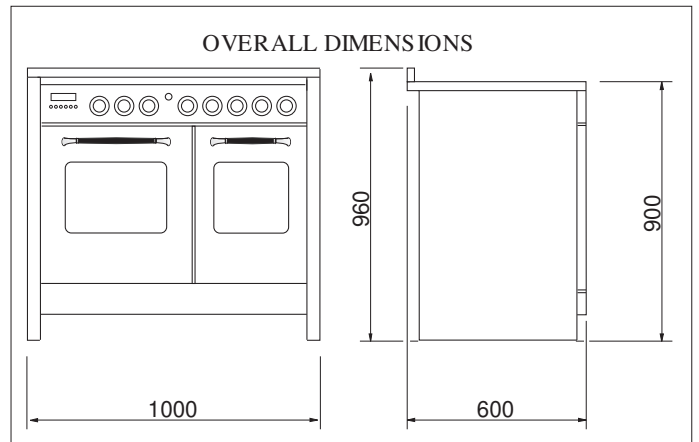
**WARNINGS**

The technical data are indicated on the data nameplate placed on the inside of the front appliance drawer.

The adjustment conditions are stated on the label applied on the packaging and on the appliance.

Do not use the oven door handle to move the appliance, such as to remove it from the packaging.

The appliance is in class 1 or class 2 subclass 1.

INSTALLATION

IMPORTANT: The coating of the furniture must be able to withstand high temperatures (min. 90°C).

If the appliance is to be installed near units, leave the minimum gaps specified in the table below.

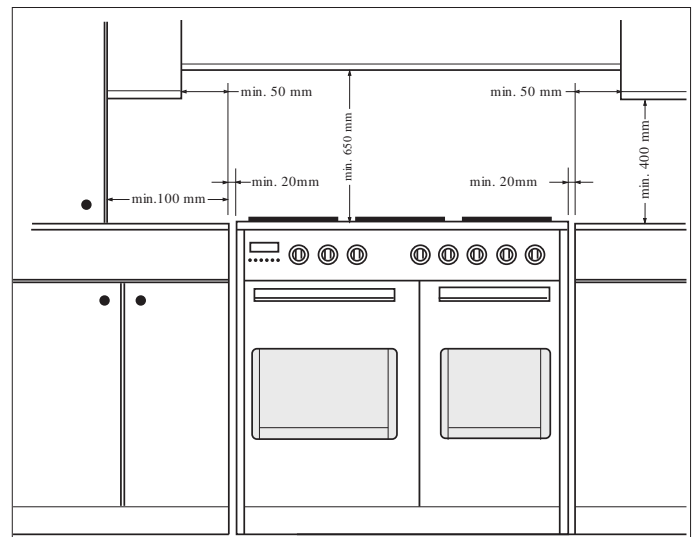

The cooker is fitted with 4 legs for an eventual alignment in height with the furniture (fig 8).

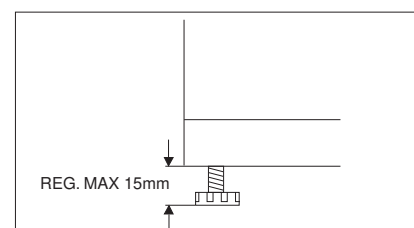

Fig. 8

GAS CONNECTING

This appliance shall be installed in accordance with the regulations in force and only in a well-ventilated space. Read the instructions before installing or using this appliance.

IMPORTANT

This cooker is supplied for use on Natural Gas Only and cannot be used for any other gas without modification.

Conversion for use on LPG and other gases must only be undertaken by a qualified person. For information for use on other gases contact your local Service Centre.

The cooker must be installed by a qualified person in accordance with the Gas Safety (Installation and Use) (Amendment) Regulations 1990 and the relevant building/I.E.E. Regulations.

Failure to install the appliance correctly could invalidate any manufacturer's warranty and lead to prosecution under the above quoted regulations.

Provision for Ventilation

The room containing the cooker should have an air supply in accordance with BS 5440: Part 2: 1989. The room must have an opening windows or equivalent; some rooms may also require a permanent vent. If the room has a volume between 5 and 10m³, it will require an air vent of 50cm² effective area unless it has a door which opens directly to the outside. If the room has a volume of less than 5m³, it will require an air vent of 100cm² effective area. If there are other fuel burning appliances in the same room, BS 5440: Part 2: 1989 should be consulted to determine air vent requirements. Ensure that the room containing the cooker is well ventilated, keep natural ventilation holes or install a mechanical ventilation device (mechanical cooker hood). Prolonged intensive use of the appliance may call for additional ventilation, for example opening of a window, or more effective ventilation, for example increasing the level of mechanical ventilation where present. This cooker is not fitted with a device for discharging the products of combustion. Ensure that the ventilation rules and regulations are followed. Excess steam from the oven, vents out at the top back edge of the cooker, so make sure that the walls behind and near the cooker are resistant to heat, steam and condensation. Your cooker must stand on a flat surface so that when it is in position the hob is level. When in position check that the cooker is level by using a spirit level and adjust the 2 feet at the rear and the 2 feet at the front if necessary. It is important that the cooker is stable and level for the overall cooking performance.

Remember that the quantity of air necessary for combustion must never be less than 2m³/h for each kW of power (see total power in kW on the appliance data plate placed on the drawer).

Gas Safety (Installation & Use) Regulations

It is the law that all gas appliances are installed by competent persons in accordance with the current edition of the Installation & Use Regulations. It is in your interest and that of safety to ensure compliance with the law.

In the UK, CORGI registered installers work to safe standards of practice.

The cooker must also be installed in accordance with BS 6172: 1990.

Failure to install the cooker correctly could invalidate the warranty liability claims and could lead to prosecution.

Gas Connection

Prior to installation, ensure that the local distribution conditions (nature of the gas and gas pressure) and the adjustment conditions are compatible. The adjustment conditions for this appliance are stated on the rating plate which can be found on the inside of the front appliance drawer.

This appliance is not designed to be connected to a combustion products evacuation device. Particular attention should be given to the relevant requirements regarding ventilation.

Connection to the cooker should be made with an approved appliance flexible connection to BS 669. Models for use with LPG should be fitted with a hose suitable for LPG and capable of withstanding 50mbar pressure. A length of 0.9 to 1.25m is recommended. The length of hose chosen should be such that when the cooker is in situ, the hose does not touch the floor.

The temperature rise of areas at the rear of the cooker that are likely to come in contact with the flexible hose do not exceed 70°C. Gas pressure may be checked on a semi-rapid hob burner. Remove the appropriate injector and attach a test nipple. Light the other burners and observe that the gas pressure complies with the gas standards in force.

Certain types of cookers can be set for supply both on the right and lefthand side. In this case it is sufficient to reverse the position of the cad nipple reducer. At the end make sure that there is no leakage of gas.

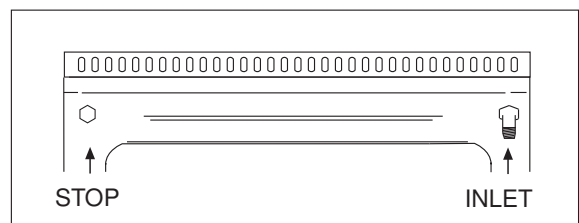

ELECTRICAL CONNECTION

This appliance must be installed by a qualified person in accordance with the latest edition of the IEE Regulations and in compliance with the manufacturer instructions.

Ensure that the voltage is the same as that stated on the rating plate. The rating plate which can be found on the inside of the front appliance drawer.

WARNING! THIS APPLIANCE MUST BE EARTHED

The power supply must be fitted with a disconnect switch in which the distance between contacts permits total disconnection in accordance with overvoltage category III, as required by installation regulations.

Be sure that the earth wire green/yellow is not interrupted by the switch

We recommend that the cooker circuit is rated to 13 amps. Cable type HO5 RRF 3 X 2.5 mm²

Connecting the mains cable

Open the mains terminal block cover as shown, unscrew screw "A" the cable clamp and unscrew (not fully) the screws in the mains terminal block "L N E" which secure the three wires of the mains cable. Fit the cable and refit screw "A" the cable clamp.

Allow sufficient cable length for the cooker to be pulled out for cleaning, but do not let it hang closer than 50mm (2") to the floor. The cable can be looped if necessary, but make sure that it is not kinked or trapped when the cooker is in position.

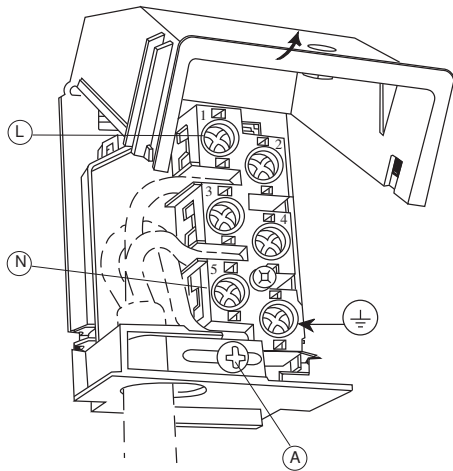

IMPORTANT

The wires in the mains lead are coloured in accordance with the following code:

- GREEN AND YELLOW.....EARTH
- BLUENEUTRAL
- BROWN.....LIVE

REPLACEMENT OF THE CABLE

In case the cable is damaged, replace it in accordance with the following instructions:

- open the box of the supply board as described on the picture below;
- unscrew screw "A" fixing the cable;
- replace the cable with one of the same length and in accordance with the features described on the table; switch the appliance off, and close the gas tap
- the 'green-yellow' earth wire must be connected to the terminal "⊥" and it must be about 10 mm longer than the live wires;
- the "blue" neutral wire must be connected to the terminal marked with letter "N";
- the live wire must be connected to the terminal marked with letter "L".

GAS ADJUSTMENT

Conversion to LPG

Always isolate the cooker from the electricity supply, turn off the gas supply temporarily and proceed as follows.

- change the injectors,
- adjust the minimum flow of the burners.

REPLACEMENT OF WORK-TOP INJECTORS

In order to change the work-top injectors, it is necessary to act as follows: remove the grids, remove burners and flame-spreaders (see fig.A), change the injector (see fig.B) and replace it with another one suitable for the new type of gas (see table D). Re-assemble everything in the opposite direction, paying attention to place the flame-spreader in the right way on the burner.

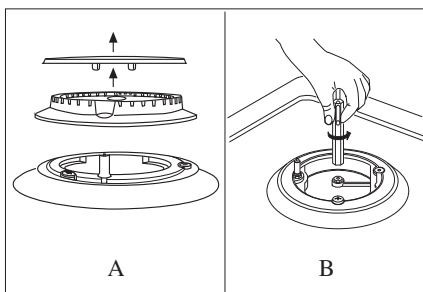

GENERAL INJECTORS TABLE						
Kind of gas	mbar	Nozzle mm/100	Burners Posizione-type	Power Watt		Consum. max.
				max.	min.	
NATURAL	20	115	-Rapide	3000	750	286 l/h
		97	-Semi rapide	1750	480	167 l/h
		128	-Triple crown	3300	1300	315 l/h
G.P.L.	30	85	-Rapide	3000	750	219 g/h
BUTANE	28	65	-Semi rapide	1750	480	128 g/h
PROPANE	37	93	-Triple crown	3300	1300	241 g/h

MINIMUM FLOW ADJUSTMENT FOR WORK-TOP TAPS

In order to adjust the minimum, act as follows: switch the burner on, and turn the knob towards the minimum flow position . Remove the knob from the tap, introduce a little screwdriver in the tap rod (fig. 11).

Attention: in taps with security valve, the minimum adjusting screw "Z" is placed outside the rod tap (fig. 12).

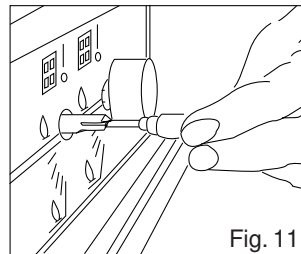

Fig. 11

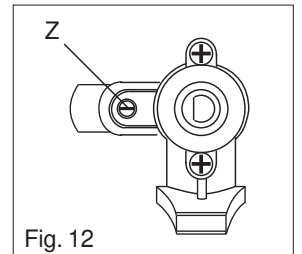

Fig. 12

Unscrew the adjusting screw in order to increase the flow or screw it to decrease the flow.

The right adjustment is obtained when the flame has a length of about 3 or 4 mm.

For butane/propane gas, the adjusting screw must be tight screwed. Make sure that the flame does not go out passing quickly from the max. flow to the minimum flow .

Assemble the knob again.

APPLIANCE MAINTENANCE

WARNINGS

Isolate the cooker from the electricity supply before attempting to replace the oven lamp.

The oven lamp used is of a special type withstanding high temperatures. To replace it, act as follows: disassemble the protecting glass (A) and replace the burnt lamp with one of the same type. Reassemble the protecting glass.

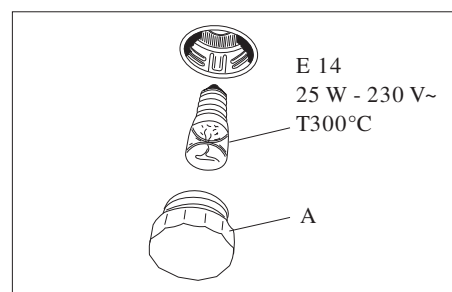

GAS TAP LUBRICATION

If the hob's gas control knobs become stiff over time, they should be lubricated with an appropriate lubricant. This must be carried out by a Technical Service only.

For your safety

The product should only be used for its intended purpose which is for the cooking of domestic foodstuffs.

Under no circumstances should any external covers be removed for servicing or maintenance except by suitably qualified personnel.

Do's and Do Not's

Do make sure you understand the controls before using the cooker.

Do check that all controls on the cooker are turned off after use.
Do always stand back when opening an oven door to allow heat to disperse.

Do always use dry, good quality oven gloves when removing items from the oven.

Do take care when removing items from the oven, as the contents may be hot.

Do always keep the oven doors closed when the cooker is not in use.

Do always place pans centrally over the hob burners and position them so that the handles cannot accidentally be caught or knocked or become heated by other burners.

Do keep the cooker clean, as a build up of grease or fat from cooking can cause a fire.

Do always allow the cooker to cool before cleaning.

Do always follow the basic principles of food handling and hygiene to prevent the possibility of bacterial growth.

Do always keep ventilation slots clear of obstructions.

Do always turn off the electricity before cleaning or replacing an oven lamp.

Do always use a CORGI registered engineer for servicing.

Do not allow children near the cooker when in use as all surfaces will become hot during and after cooking.

Do not allow anyone to sit or stand on any part of the cooker.

Do not heat up unopened food containers as pressure can build up causing the container to burst.

Do not store chemicals, food stuffs, pressurised containers in or on the cooker, or in cabinets immediately above or next to the cooker.

Do not fill a deep fat frying pan more than 1/3 full of fat, oil, or use a lid.

DO NOT LEAVE UNATTENDED WHILE COOKING.

Do not place flammable or plastic items on or near the hob burners.

Do not use proprietary spillage collectors on the hob burners.

Do not use the cooker as a room heater.

Do not dry clothes or place other items over or near to the hob burners or oven doors.

Do not wear garments with long flowing sleeves whilst cooking.

Do not place inflammable materials in the oven or the compartment below the oven.

Do not allow fat or oil to build up in the oven trays, grill pan or oven base.

Do not place cooking utensils or plates onto the oven base.

Do not grill food containing fat without using the grid.

Do not cover the grilling grid with aluminium foil.

Do not place hot enamel parts in water, leave them to cool first.

Do not allow vinegar, coffee, milk, saltwater, lemon or tomato juice to remain in contact with enamel parts (inside the oven and oven trays).

Do not use abrasive cleaners or powders that will scratch the surface of the stainless steel and the enamel.