



Maintenance and Service Guide

SUMMARY

This guide provides maintenance information about such topics as spare parts, removal and replacement of parts, security, and backing up.

Legal information

© Copyright 2023 HP Development Company, L.P.

AMD, Freesync, Radeon, and Ryzen are trademarks of Advanced Micro Devices, Inc. Bluetooth is a trademark owned by its proprietor and used by HP Inc. under license. The terms HDMI, HDMI High-Definition Multimedia Interface, and the HDMI Logo are trademarks or registered trademarks of HDMI Licensing Administrator, Inc. Intel is a trademark of Intel Corporation or its subsidiaries in the U.S. and/or other countries. MediaTek is a trademark of MediaTek Inc. Microsoft and Windows are either registered trademarks or trademarks of Microsoft Corporation in the United States and/or other countries. NVIDIA, GeForce RTX, and RTX are trademarks and/or registered trademarks of NVIDIA Corporation in the U.S. and other countries. NVMe is a registered trademark of NVM Express. PCIe is a US registered trademark and/or service mark of PCI-SIG. Realtek™ is a trademark of Realtek Semiconductor Corporation. USB Type-C and USB-C are registered trademarks of USB Implementers Forum. DisplayPort™ and the DisplayPort™ logo are trademarks owned by the Video Electronics Standards Association (VESA®) in the United States and other countries. Miracast and Wi-Fi are registered trademarks of Wi-Fi Alliance.

The information contained herein is subject to change without notice. The only warranties for HP products and services are set forth in the express warranty statements accompanying such products and services. Nothing herein should be construed as constituting an additional warranty. HP shall not be liable for technical or editorial errors or omissions contained herein.

First Edition: May 2023

Document Part Number: N56372-001

Product notice

This guide describes features that are common to most models. Some features may not be available on your computer.

Not all features are available in all editions or versions of Windows. Systems may require upgraded and/or separately purchased hardware, drivers, software or BIOS update to take full advantage of Windows functionality. Windows is automatically updated, which is always enabled. High-speed internet and Microsoft account required. ISP fees may apply and additional requirements may apply over time for updates. See <http://www.windows.com>.

If your product ships with Windows in S

Mode: Windows in S Mode works exclusively with apps from the Microsoft Store within Windows. Certain default settings, features, and apps cannot be changed. Some accessories and apps that are compatible with Windows may not work (including some antivirus, PDF writers, driver utilities, and accessibility apps), and performance may vary, even if you switch out of S Mode. If you switch to Windows, you cannot switch back to S Mode. Learn more at Windows.com/SmodeFAQ.

To access the latest user guides, go to <http://www.hp.com/support>, and follow the instructions to find your product. Then select **Manuals**.

Software terms

By installing, copying, downloading, or otherwise using any software product preinstalled on this computer, you agree to be bound by the terms of the HP End User License Agreement (EULA). If you do not accept these license terms, your sole remedy is to return the entire unused product (hardware and software) within 14 days for a full refund subject to the refund policy of your seller.

For any further information or to request a full refund of the price of the computer, please contact your seller.

Safety warning notice

Reduce the possibility of heat-related injuries or of overheating the computer by following the practices described.

 **WARNING!** To reduce the possibility of heat-related injuries or of overheating the computer, do not place the computer directly on your lap or obstruct the computer air vents. Use the computer only on a hard, flat surface. Do not allow another hard surface, such as an adjoining optional printer, or a soft surface, such as pillows or rugs or clothing, to block airflow. Also, do not allow the AC adapter to come into contact with the skin or a soft surface, such as pillows or rugs or clothing, during operation. The computer and the AC adapter comply with the user-accessible surface temperature limits defined by applicable safety standards.

Important notice about Customer Self-Repair parts

Your computer includes Customer Self-Repair parts and parts that should be accessed only by an authorized service provider.

 **IMPORTANT:** See "Removal and replacement procedures for Customer Self-Repair parts" for details.

Accessing parts described in "Removal and replacement procedures for authorized service provider parts" can damage the computer or void your warranty.

Table of contents

1 Product description	1
2 Getting to know your computer	5
Right side	5
Left side	6
Display	7
Low blue light mode (select products only)	7
Wake-on-voice (select products only)	8
Keyboard area	9
Touchpad settings and components	9
Touchpad settings	9
Adjusting touchpad settings	9
Turning on the touchpad	9
Touchpad components	9
Lights	10
Special keys	11
HP OMEN Gaming Hub	13
Rear	14
Bottom	15
Labels	16
3 Illustrated parts catalog	19
Computer major components	19
Display assembly subcomponents	22
Miscellaneous parts	24
4 Removal and replacement procedures preliminary requirements	26
Tools required	26
Service considerations	26
Plastic parts	26
Cables and connectors	26
Drive handling	26
Electrostatic discharge information	27
Generating static electricity	27
Preventing electrostatic damage to equipment	28
Personal grounding methods and equipment	28
Grounding the work area	29
Recommended materials and equipment	29
Cleaning your computer	30
Enabling HP Easy Clean (select products only)	30

Removing dirt and debris from your computer.....	30
Cleaning your computer with a disinfectant.....	31
Caring for wood veneer (select products only).....	32
Packaging and transporting guidelines.....	32
Accessing support information.....	33
5 Removal and replacement procedures for Customer Self-Repair parts	35
Component replacement procedures	35
Preparation for disassembly.....	35
Solid-state drive.....	35
Memory modules.....	37
6 Removal and replacement procedures for authorized service provider parts.....	39
Component replacement procedures	39
Preparation for disassembly.....	39
Bottom cover	39
Battery.....	41
WLAN module, limited-feature models	42
WLAN module, full-feature models	44
Speakers.....	45
Fans, limited-feature models.....	46
USB board, full-feature models	47
Heat sink assembly.....	48
USB board, limited-feature models.....	50
System board with heat sink	50
IR board.....	56
Audio board, full-feature models.....	57
Audio board, limited-feature models	58
Touchpad.....	59
Fans, full-feature models.....	61
Power connector, limited-feature models.....	62
Display assembly.....	63
Top cover with keyboard.....	71
7 Using Setup Utility (BIOS)	73
Starting Setup Utility (BIOS).....	73
Updating Setup Utility (BIOS).....	73
Determining the BIOS version.....	73
Preparing for a BIOS update	74
Downloading a BIOS update	74
Installing a BIOS update	74
8 Using HP PC Hardware Diagnostics	76
Using HP PC Hardware Diagnostics Windows (select products only).....	76
Using an HP PC Hardware Diagnostics Windows hardware failure ID code.....	76
Accessing HP PC Hardware Diagnostics Windows.....	76
Accessing HP PC Hardware Diagnostics Windows from HP Support Assistant.....	76
Accessing HP PC Hardware Diagnostics Windows from the Start menu (select products only).....	77

Downloading HP PC Hardware Diagnostics Windows.....	77
Downloading the latest HP PC Hardware Diagnostics Windows version from HP.....	77
Downloading the HP PC Hardware Diagnostics Windows from the Microsoft Store.....	77
Downloading HP Hardware Diagnostics Windows by product name or number (select products only).....	77
Installing HP PC Hardware Diagnostics Windows.....	78
Using HP PC Hardware Diagnostics UEFI.....	78
Using an HP PC Hardware Diagnostics UEFI hardware failure ID code.....	78
Starting HP PC Hardware Diagnostics UEFI.....	78
Starting HP PC Hardware Diagnostics UEFI through HP Hotkey Support software (select products only).....	79
Downloading HP PC Hardware Diagnostics UEFI to a USB flash drive.....	79
Downloading the latest HP PC Hardware Diagnostics UEFI version.....	80
Downloading HP PC Hardware Diagnostics UEFI by product name or number (select products only).....	80
Using Remote HP PC Hardware Diagnostics UEFI settings (select products only).....	80
Downloading Remote HP PC Hardware Diagnostics UEFI.....	80
Downloading the latest Remote HP PC Hardware Diagnostics UEFI version.....	80
Downloading Remote HP PC Hardware Diagnostics UEFI by product name or number.....	80
Customizing Remote HP PC Hardware Diagnostics UEFI settings.....	81
9 Backing up, restoring, and recovering.....	82
Backing up information and creating recovery media.....	82
Using Windows tools for backing up.....	82
Using the HP Cloud Recovery Download Tool to create recovery media (select products only).....	82
Restoring and recovering your system.....	82
Creating a system restore.....	83
Restoring and recovery methods.....	83
Recovering using HP Recovery media.....	83
Changing the computer boot order.....	84
Using HP Sure Recover (select products only).....	84
10 Specifications.....	85
Computer specifications.....	85
Display specifications.....	86
Solid-state drive specifications.....	86
11 Power cord set requirements.....	88
Requirements for all countries.....	88
Requirements for specific countries and regions.....	88
12 Recycling.....	90
Index.....	91

1 Product description

This table provides detailed product information.

Table 1-1 Product components and their descriptions

Category	Description
Product Name	OMEN by HP 16.1 inch Gaming Laptop PC
	Model numbers: 16-x0xxx
	CTO model number: 16z-x000
Processor	AMD® Ryzen™ processors
	AMD Ryzen 9 PRO 7940HS (4.0 GHz, up to 5.2 GHz AMD Boost Technology, 8 cores, 16 MB L3 cache, 54 W)
	AMD Ryzen 9 PRO 7940H (4.0 GHz, up to 5.2 GHz AMD Boost Technology, 8 cores, 16 MB L3 cache, 45 W)
	AMD Ryzen 7 PRO 7840HS (3.8 GHz, up to 5.1 GHz AMD Boost Technology, 8 cores, 16 MB L3 cache, 54 W)
	AMD Ryzen 7 PRO 7840H (3.8 GHz, up to 5.0 GHz AMD Boost Technology, 8 cores, 16 MB L3 cache, 45 W)
	AMD Ryzen 5 PRO 7640HS (3.0 GHz, up to 5.0 GHz AMD Boost Technology, 6 cores, 16 MB L3 cache, 54 W)
Graphics controller	Internal graphics
	AMD Radeon®
	Discrete/hybrid graphics
	<ul style="list-style-type: none">• NVIDIA® GeForce RTX® 4070 (80 W)
	<ul style="list-style-type: none">• NVIDIA GeForce RTX 4060 (80 W)
	<ul style="list-style-type: none">• NVIDIA GeForce RTX 4050 (80 W)
	<ul style="list-style-type: none">• NVIDIA GeForce RTX 3050 (60 W)
	Supports HD Decode, DX12, and HDMI®
	Supports MR compatible (60 Hz frame rate)
	Supports GPU Performance Scaling (GPS)
	Supports VR
	Supports Graphics Switcher
	Supports FreeSync™ (internal and external)
Supports MR-certified with Microsoft® logo badge (90 Hz frame rate)	

Table 1-1 Product components and their descriptions (continued)

Category	Description
Display	40.9 cm (16.1 in), white light-emitting diode (WLED), antiglare, ultrawide viewing angle (UWVA)
	Quad High Definition (QHD) (2560 × 1440), 100% sRGB, embedded DisplayPort™ (eDP) 1.4 without panel self-refresh (PSR), low blue light, 300 nits, 240 Hz
	Full High Definition (FHD) (1920 × 1080), 100% sRGB, low blue light, eDP 1.4 without PSR, 300 nits, 165 Hz
	FHD, 45% NTSC, eDP 1.3, 250 nits, 144 Hz
Memory	Two SODIMM slots, customer accessible and upgradeable, supporting up to 32 GB of RAM
	DDR5-5600, 1.1 V, dual-channel support
	Supports the following configurations:
	<ul style="list-style-type: none"> • 32 GB (16 GB × 2) • 16 GB (8 GB × 2)
Primary storage	M.2 solid-state drive (PCIe®-4 × 4, 2280, non-volatile memory express (NVMe®), three-layer cell (TLC))
	2 TB
	1 TB
	2 × 512 GB
	512 GB
Audio	Audio brand: BANG and OLUFSEN
	Dual speakers
	Supports Far Field Cortana
	Supports Alexa
	Supports HP Audio Boost
	Supports DTS X: Ultra
Video	HP True Vision FHD Camera - indicator LED, USB 2.0, HD BSI sensor, f2.0, 80° narrow field-of-view (NFOV)
	1080p by 30 frames per second (fps)
	Dual-array, digital microphone with appropriate beamforming software - echo cancellation, noise suppression
Wireless	Wireless Local Area Network (WLAN) with dual antennas (M.2 module/PCIe)
	<ul style="list-style-type: none"> • MediaTek™ RZ616 Wi-Fi® 6E Bluetooth® 5.3 AIM-T WLAN • Realtek™ 8852CE Wi-Fi 6E Bluetooth 5.3 WLAN
	Support for Miracast®
	Support for Modern Standby (connected)
RJ-45 (network)	Integrated 10/100/1000 GbE LAN

Table 1-1 Product components and their descriptions (continued)

Category	Description
Ports	Hot plug/unplug and auto detect for correct output to wide-aspect vs standard aspect video
	Audio-out (headphone)/audio-in (microphone) combo jack
	RJ-45 (network) jack
	AC smart adapter plug
	HDMI 2.1 supporting up to 8 K @ 60 Hz with HDCP 2.2
	Full-feature models:
	USB 3.2 Gen 1 Type-A port, right side; supports HP Sleep & Charge
	USB 3.2 Gen 1 Type-A port, rear
	USB 3.2 Gen2 Type-C® (2), supports:
	- Display Port 1.4 out up to 4 K @ 60 Hz and HDMI 1.4 out with adapter
	- Power delivery (65 W/100 W input [20 V @ 5A and 20 V @ 3.25A])
	- Data transfer
	- HDMI 2.1 output up to 4 K @ 60 Hz with HDCP 2.2 with adapter capable of HDMI 2.1
	- HP Sleep & Charge
Limited-feature models:	
USB 3.2 Gen 1 Type-A port (2), right side	
USB 3.2 Gen 1 Type-A port, left side; supports HP Sleep & Charge	
USB 3.2 Gen 1 Type-C®, left side, supports:	
- Display Port 1.4 out up to 8 K @ 60 Hz and HDMI 1.4 out with adapter	
- Power delivery (65 W/100 W input [20 V @ 5A and 20 V @ 3.25A])	
- Data transfer	
- HDMI 2.1 output up to 8 K @ 60 Hz with HDCP 2.2 with adapter capable of HDMI 2.1	
- HP Sleep & Charge	
Sensor	IR thermal sensor
Keyboard/pointing devices	Keyboard
	Backlit, 4-zone RGB lighting
	Backlit, 4-zone RGB lighting, numeric keypad
	Backlit, 1-zone lighting
	Backlit, 1-zone lighting, numeric keypad
	Clickpad with image sensor
	Supports Microsoft® precision gestures
	Supports modern trackpad gestures
	Multitouch gestures enabled
	Taps enabled as default

Table 1-1 Product components and their descriptions (continued)

Category	Description
Power requirements	Battery
	6 cell, 83 Whr
	4 cell, 70 Whr
	Long life
	Fast charge
	Smart AC adapter
	280 W, 4.5 mm, standard, right angle, 3 pin
	230 W, 4.5 mm, power correction factor (PFC), slim, right angle, 3 pin
	200 W, 4.5 mm, PFC, slim, right angle, 3 pin
	Power cord
C13, premium, 1.0 m (3.3 ft)	
Security	Trusted Platform Module (TPM) 2.0
	Camera privacy cover
Operating system	Windows® 11 Pro
	Windows 11 Pro Education
	Windows 11 Home - HP recommends Windows 11 Pro for Business
	Windows 11 Home Single Language - HP recommends Windows 11 Pro for Business
	Windows 11 Pro (Windows 11 Enterprise or Windows 10 Enterprise available with a Volume Licensing Agreement)
	Windows 11 Pro (preinstalled with Windows 10 Pro Downgrade)
	FreeDOS
Serviceability	AC adapter
	Solid-state drive
	Memory modules

2 Getting to know your computer

Your computer features top-rated components. This chapter provides details about your components, where they are located, and how they work.

Right side

Identify the components on the right side of the computer.

 **NOTE:** Refer to the illustration that most closely matches your computer.

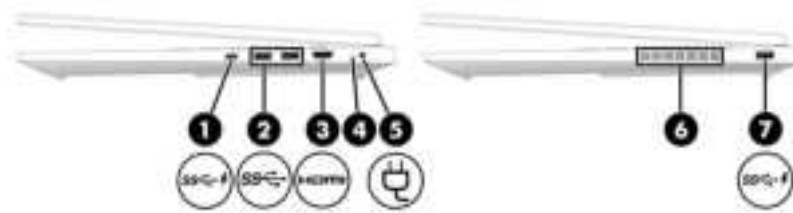

Table 2-1 Right-side components and their descriptions







Component	Description
(1) 	<p>USB Type-C® port with HP Sleep and Charge</p> <p>Connects a USB device, provides high-speed data transfer, and charges small devices (such as a smartphone), even when the computer is off.</p> <p>NOTE: Use a standard USB Type-C charging cable or cable adapter (purchased separately) when charging a small external device.</p> <p>- and -</p> <p>Connects a display device that has a USB Type-C connector, providing DisplayPort™ output.</p>
(2) 	<p>USB ports (2)</p> <p>Connect USB devices, provide high-speed data transfer, and (for select products) charge small devices (such as a smartphone) when the computer is on or in Sleep mode.</p> <p>NOTE: Use a standard USB Type-A charging cable or cable adapter (purchased separately) when charging a small external device.</p>
(3) 	<p>HDMI® port</p> <p>Connects an optional video or audio device, such as a high-definition television, any compatible digital or audio component, or a high-speed High-Definition Multimedia Interface® (HDMI) device.</p>

Table 2-1 Right-side components and their descriptions (continued)

Component	Description
(4)  AC adapter and battery light	<ul style="list-style-type: none"> White: The AC adapter is connected and the battery is fully charged. Blinking amber: The AC adapter is disconnected and the battery has reached a low battery level. Amber: The AC adapter is connected and the battery is charging. Off: The battery is not charging.
(5)  Power connector	Connects an AC adapter.
(6) Vent	<p>Enables airflow to cool internal components.</p> <p>NOTE: The computer fan starts up automatically to cool internal components and prevent overheating. It is normal for the internal fan to cycle on and off during routine operation.</p>
(7)  USB port with HP Sleep and Charge	<p>Connects a USB device, provides high-speed data transfer, and charges small devices (such as a smartphone), even when the computer is off.</p> <p>NOTE: Use a standard USB Type-A charging cable or cable adapter (purchased separately) when charging a small external device.</p>

Left side

Identify the components on the left side of the computer.

 **NOTE:** Refer to the illustration that most closely matches your computer.



Table 2-2 Left-side components and their descriptions



Component	Description
(1)  RJ-45 (network) jack/status lights	<p>Connects a network cable.</p> <ul style="list-style-type: none"> White: The network is connected. Amber: Activity is occurring on the network.

Table 2-2 Left-side components and their descriptions (continued)

Component	Description
<p>(2)  USB port with HP Sleep and Charge</p>	<p>Connects a USB device, provides high-speed data transfer, and charges small devices (such as a smartphone), even when the computer is off.</p> <p>NOTE: Use a standard USB Type-A charging cable or cable adapter (purchased separately) when charging a small external device.</p>
(3) Vent (select products only)	<p>Enables airflow to cool internal components.</p> <p>NOTE: The computer fan starts up automatically to cool internal components and prevent overheating. It is normal for the internal fan to cycle on and off during routine operation.</p>
<p>(4)  Audio-out (headphone)/Audio-in (microphone) combo jack</p>	<p>Connects optional powered stereo speakers, headphones, earbuds, a headset, or a television audio cable. Also connects an optional headset microphone. This jack does not support optional standalone microphones.</p> <p>WARNING! To reduce the risk of personal injury, adjust the volume before putting on headphones, earbuds, or a headset. For additional safety information, see the <i>Regulatory, Safety, and Environmental Notices</i>.</p> <p>To access this guide:</p> <ul style="list-style-type: none"> ■ Select the Search icon in the taskbar, type HP Documentation in the search box, and then select HP Documentation. <p>NOTE: When a device is connected to the jack, the computer speakers are disabled.</p>
<p>(5)  USB Type-C ports with HP Sleep and Charge (2)</p>	<p>Connect USB devices, provide high-speed data transfer, and charge small devices (such as a smartphone), even when the computer is off.</p> <p>NOTE: Use a standard USB Type-C charging cable or cable adapter (purchased separately) when charging a small external device.</p> <p>- and -</p> <p>Connect display devices that have a USB Type-C connector, providing DisplayPort output.</p>

Display

The computer display can include essential components such as speakers, antennas, cameras, and microphones.

Low blue light mode (select products only)

Your computer display is shipped from the factory in low blue light mode for improved eye comfort and safety. Also, blue light mode automatically adjusts blue light emissions when you are using the computer at night or for reading.

WARNING! To reduce the risk of serious injury, read the *Safety & Comfort Guide*. It describes proper workstation setup and proper posture, health, and work habits for computer users. The *Safety &*

Comfort Guide also provides important electrical and mechanical safety information. The *Safety & Comfort Guide* is available on the web at <http://www.hp.com/ergo>.

Wake-on-voice (select products only)

Use the wake-on-voice feature to bring the computer out of the Sleep state quickly.

To access the wake-on-voice settings, follow these steps:

1. Select the **Search** icon in the taskbar, type `XiaoWei` in the search box, and then select **XiaoWei**.
2. When the tool opens, scan the QR code with your mobile device, which takes you to the settings page, where you can select your wake-on-voice features.
3. Follow the on-screen instructions.

 **NOTE:** Allow the XiaoWei app to continue running on the computer.

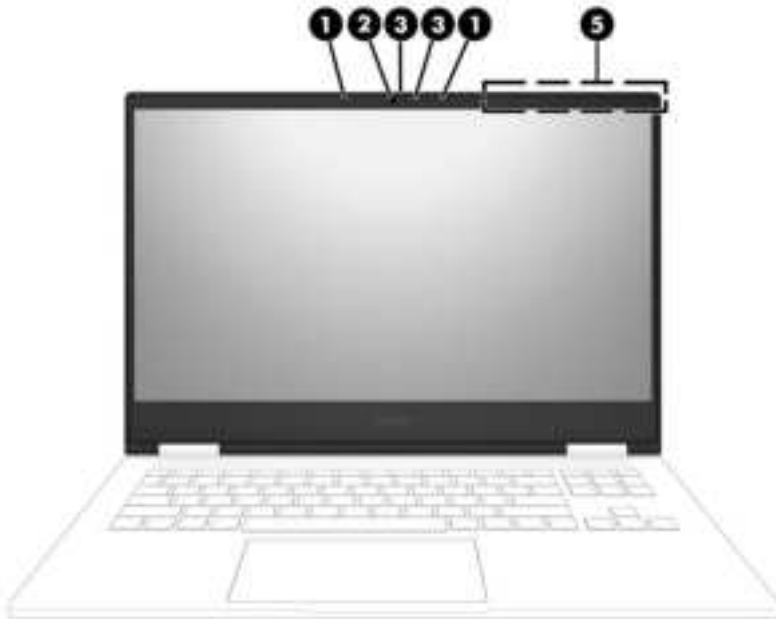

Table 2-3 Display components and their descriptions

Component	Description
(1) Internal microphones (2)	Record sound.
(2) Camera	Allows you to video chat, record video, and record still images. Some cameras also allow a facial recognition logon to Windows, instead of a password logon. NOTE: Camera functions vary depending on the camera hardware and software installed on your product.
(3) Camera privacy cover	By default, the camera lens is uncovered, but you can slide the camera privacy cover to block the camera's view. To use the camera, slide the camera privacy cover in the opposite direction to reveal the lens.
(4) Camera light	On: The camera is in use.

Table 2-3 Display components and their descriptions (continued)

Component	Description
(5) WLAN antennas*	Send and receive wireless signals to communicate with wireless local area networks (WLANs).

*The antennas are not visible from the outside of the computer. For optimal transmission, keep the areas immediately around the antennas free from obstructions.

For wireless regulatory notices, see the section of the *Regulatory, Safety, and Environmental Notices* that applies to your country or region.

To access this guide:

- Select the **Search** icon in the taskbar, type `HP Documentation` in the search box, and then select **HP Documentation**.

Keyboard area

Keyboards can vary by language.

 **NOTE:** The keyboard area, including the function keys and (select products only) power key, is disabled in stand, tent, and tablet modes. To enable the keyboard, including the power key, change to the clamshell mode.

Touchpad settings and components

Learn the touchpad settings and components.

Touchpad settings

Learn how to adjust touchpad settings.

Adjusting touchpad settings

Use these steps to adjust touchpad settings and gestures.

1. Select the **Search** icon in the taskbar, type `touchpad settings` in the search box, and then press `enter`.
2. Choose a setting.

Turning on the touchpad

Follow these steps to turn on the touchpad.

1. Select the **Search** icon in the taskbar, type `touchpad settings` in the search box, and then press `enter`.
2. Using an external mouse, click the **touchpad** button.

If you are not using an external mouse, press the `Tab` key repeatedly until the pointer rests on the **touchpad** button. Then press the `spacebar` to select the button.

Touchpad components

Identify the touchpad components.

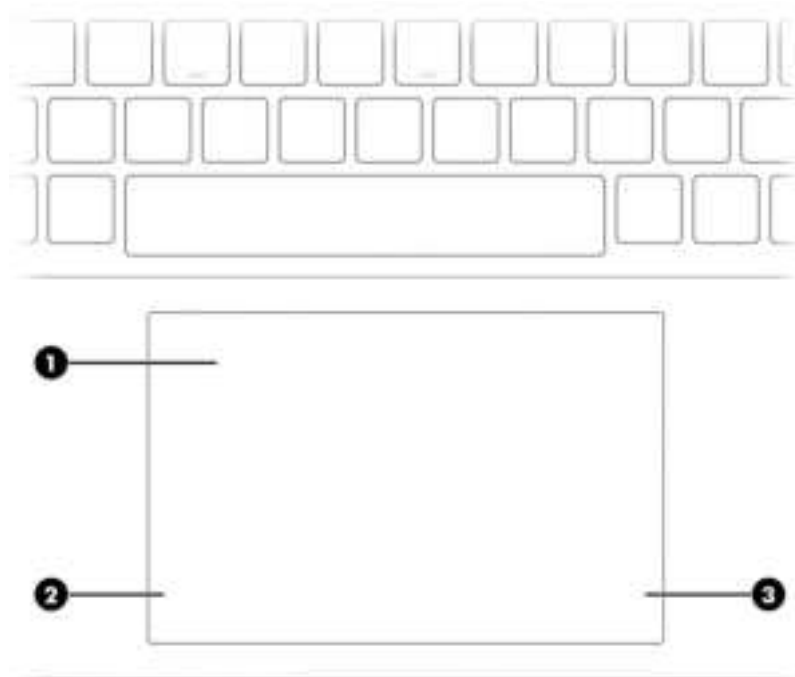



Table 2-4 Touchpad components and their descriptions

Component	Description
(1) Touchpad zone	Reads your finger gestures to move the pointer or activate items on the screen.
(2) Left touchpad button	Functions like the left button on an external mouse.
(3) Right touchpad button	Functions like the right button on an external mouse.

Lights

Identify the lights on the computer.

 **NOTE:** Your computer might look slightly different from the following illustration.

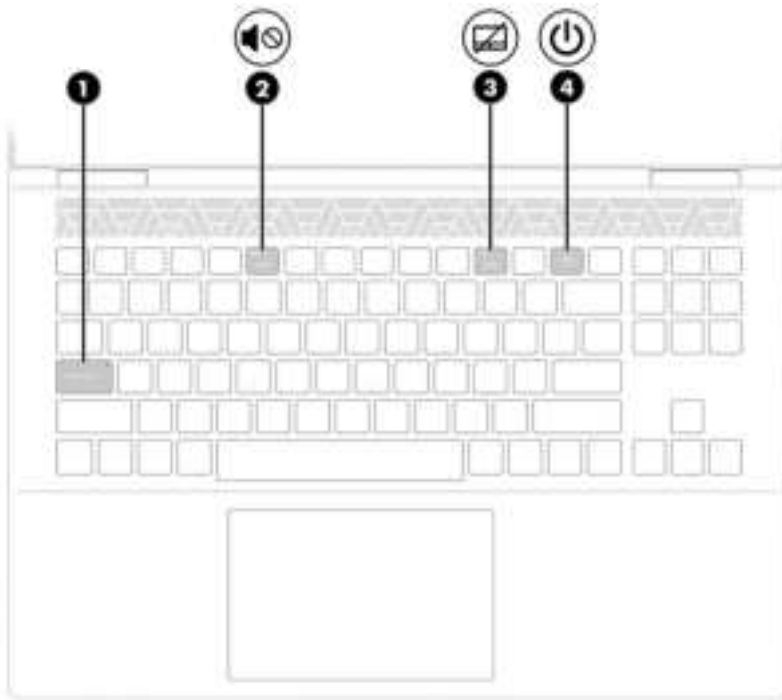





Table 2-5 Lights and their descriptions

Component		Description
(1)	Caps lock light	On: Caps lock is on, which switches the key input to all capital letters.
(2)	 Mute light	<ul style="list-style-type: none"> On: Computer sound is off. Off: Computer sound is on.
(3)	 Touchpad light	<ul style="list-style-type: none"> On: The touchpad is off. Off: The touchpad is on.
(4)	 Power light	<ul style="list-style-type: none"> On: The computer is on. Blinking (select products only): The computer is in the Sleep state, a power-saving state. The computer shuts off power to the display and other unnecessary components. Off: Depending on your computer model, the computer is off, in Hibernation, or in Sleep. Hibernation is the power-saving state that uses the least amount of power.

Special keys

Identify the special keys.

 **NOTE:** Refer to the illustration that most closely matches your computer.

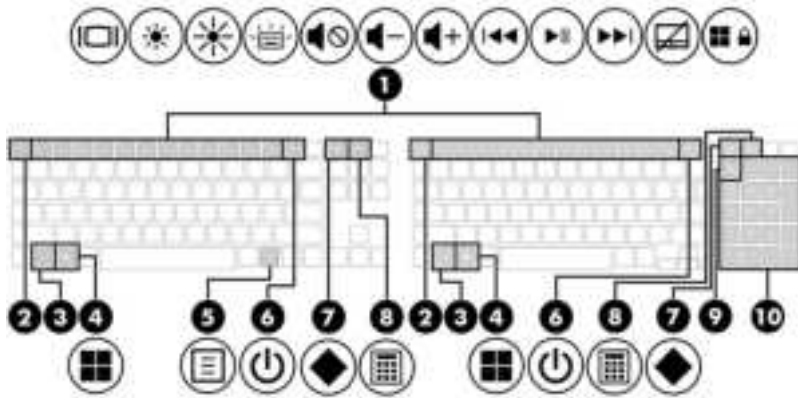

Table 2-6 Special keys and their descriptions







Component	Description
(1) Action keys	Execute frequently used system functions as defined by the icon symbols on f1 through f12 function keys.
(2) esc key	Displays system information when pressed in combination with the fn key.
(3) fn key	Executes specific functions when pressed in combination with another key.
(4)  Windows key	Opens the Start menu. NOTE: Pressing the Windows key again will close the Start menu.
(5)  Windows application key	Displays options for a selected object.
(6)  Power button	<ul style="list-style-type: none"> When the computer is off, press the button briefly to turn on the computer. When the computer is on, press the button briefly to initiate Sleep. When the computer is in the Sleep state, press the button briefly to exit Sleep (select products only). When the computer is in Hibernation, press the button briefly to exit Hibernation. <p>IMPORTANT: Pressing and holding down the power button results in the loss of unsaved information.</p> <p>If the computer has stopped responding and shutdown procedures are ineffective, press and hold the power button down for at least 10 seconds to turn off the computer.</p> <p>To learn more about your power and sleep settings:</p> <ul style="list-style-type: none"> Right-click the Power icon , and then select Power and sleep settings.
(7)  OMEN key	Opens the OMEN Gaming Hub software. See HP OMEN Gaming Hub on page 13 for more information.

Table 2-6 Special keys and their descriptions (continued)

Component	Description
(8)  Calculator key	Opens the calculator.
(9) num lock key (select products only)	Alternates between the navigational and numeric functions on the integrated numeric keypad.
(10) Integrated numeric keypad (select products only)	A separate keypad to the right of the alphabet keyboard. When num lock is pressed, the keypad can be used like an external numeric keypad. NOTE: If the keypad function is active when the computer is turned off, that function is reinstated when the computer is turned back on.

HP OMEN Gaming Hub

HP OMEN Gaming Hub allows you to customize your computer for your specific gaming needs.

- To open HP OMEN Gaming Hub, select the **Start** button, select **All apps**, select **OMEN Gaming Hub**, and then follow the on-screen instructions.

- or -

Press the **OMEN** key  at the top-right side of the keyboard.

The HP OMEN Gaming Hub dashboard provides a central location to access and configure the following features:

 **NOTE:** Some features are available on select products only.

- **Cam & Voice Enhancer:** Improve your streaming quality with AI-powered video and audio effects and enhancements (NVIDIA® RTX® GPUs only).
- **System Vitals:** Monitor the computer status and performance.
- **Undervolting:** Adjust the voltage of the computer to use less power and decrease the amount of heat generated.
- **Light Studio:** Coordinate your color scheme and easily sync your lighting effects across your OMEN devices.
- **Lighting:** Customize the keyboard lighting.
- **Network Booster:** View and adjust network priorities and settings.
- **Performance Control:** Adjust the thermal temperature and power levels of your computer to improve performance.
- **Gaming Device Lighting and Macros:** Configure the lighting and macro keys when an external supported gaming device is connected (select products only).
- **My Games:** Locate and launch games from your library.
- **Graphics Switcher:** Use Graphics Mode to switch between Hybrid or Discrete graphics.

- **Oasis Live:** A virtual room for you and your friends to game together.
- **Gallery:** View and change your OMEN wallpaper backgrounds.
- **Optimizer:** Boost your game and clean up the clutter on your computer to optimize performance.
- **Advanced PBO:** Adjust the AMD® Advanced Precision Boost Overdrive settings to fine-tune the power and performance of the AMD APU (selected models only).
- **Help:** Access “How to” information and frequently asked questions.

 **NOTE:** To minimize the dashboard, select the arrow button < at the top of the dashboard.

Rear

Identify the rear components.

 **NOTE:** Refer to the illustration that most closely matches your computer.

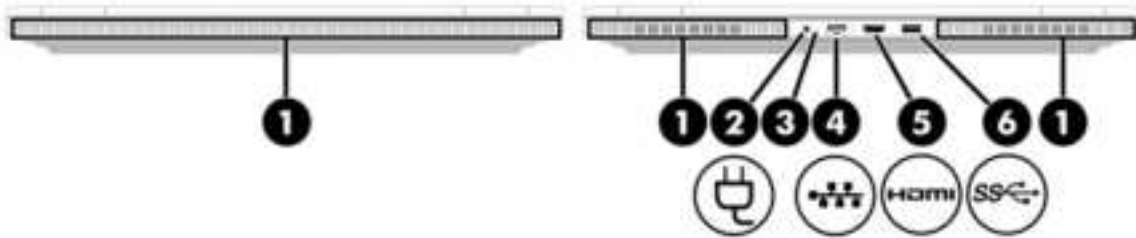

Table 2-7 Rear components and their descriptions





Component	Description
(1) Vents	Enable airflow to cool internal components. NOTE: The computer fan starts up automatically to cool internal components and prevent overheating. It is normal for the internal fan to cycle on and off during routine operation.
(2)  Power connector	Connects an AC adapter. NOTE: To ensure that your computer operates at full performance and can charge the battery when using resource-intensive applications, use the AC adapter that ships with your computer. You can use an optional 100 W/20 V Type-C adapter or power bank when running light-load tasks. System-off charging is supported only when you use a 20 V Type-C adapter or power bank.

Table 2-7 Rear components and their descriptions (continued)

Component	Description
<p>(3)</p> 	<p>AC adapter and battery light</p> <ul style="list-style-type: none"> White: The AC adapter is connected and the battery is fully charged. Blinking amber: The AC adapter is disconnected and the battery has reached a low battery level. Amber: The AC adapter is connected and the battery is charging. Off: The battery is not charging.
<p>(4)</p> 	<p>RJ-45 (network) jack/status lights</p> <p>Connects a network cable.</p> <ul style="list-style-type: none"> White: The network is connected. Amber: Activity is occurring on the network.
<p>(5)</p> 	<p>HDMI port</p> <p>Connects an optional video or audio device, such as a high-definition television, any compatible digital or audio component, or a high-speed High-Definition Multimedia Interface (HDMI) device.</p>
<p>(6)</p> 	<p>USB SuperSpeed port</p> <p>Connects a USB device, provides high-speed data transfer, and (for select products) charges small devices (such as a smartphone) when the computer is on or in Sleep mode.</p> <p>NOTE: Use a standard USB Type-A charging cable or cable adapter (purchased separately) when charging a small external device.</p>

Bottom

Identify the bottom components.

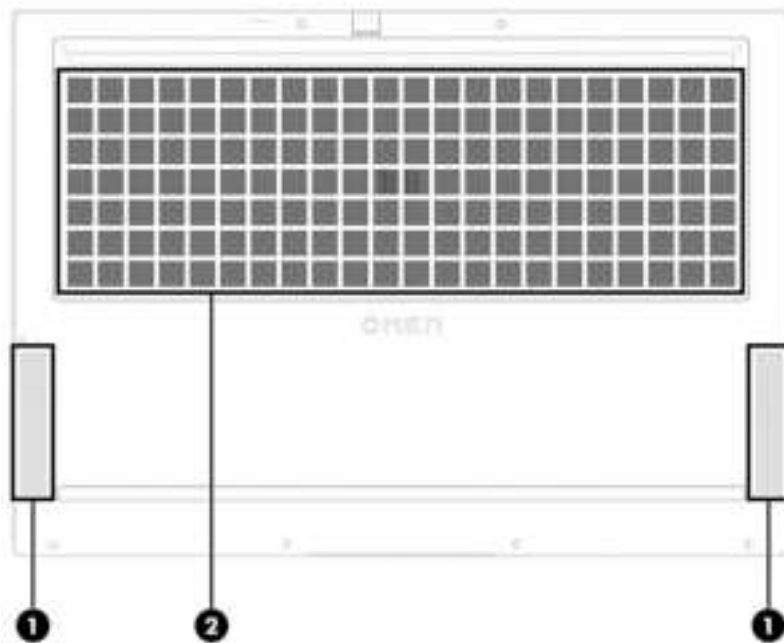

Table 2-8 Bottom components and their descriptions

Component	Description
(1) Speakers (2)	Produce sound.
(2) Vent	Enables airflow to cool internal components.

NOTE: The computer fan starts up automatically to cool internal components and prevent overheating. It is normal for the internal fan to cycle on and off during routine operation.

Labels

The labels affixed to the computer provide information that you might need when you troubleshoot system problems or travel internationally with the computer. Labels can be in paper form or imprinted on the product.

IMPORTANT: Check the following locations for the labels described in this section: the bottom of the computer, inside the battery bay, under the service door, on the back of the display, or on the bottom of a tablet kickstand.

- Service label—Provides important information to identify your computer. When contacting support, you might be asked for the serial number, the product number, or the model number. Locate this information before you contact support.

Your service label will resemble one of the following examples. Refer to the illustration that most closely matches the service label on your computer.



Table 2-9 Service label components

Component
(1) Serial number
(2) Product ID
(3) HP product name and model number

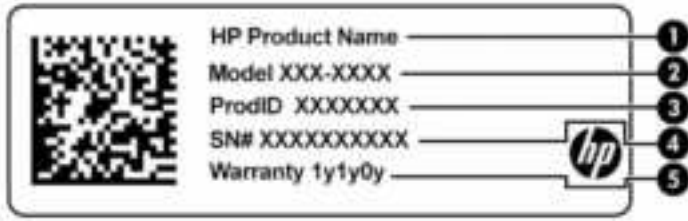

Table 2-10 Service label components

Component	
(1)	HP product name
(2)	Model number
(3)	Product ID
(4)	Serial number
(5)	Warranty period

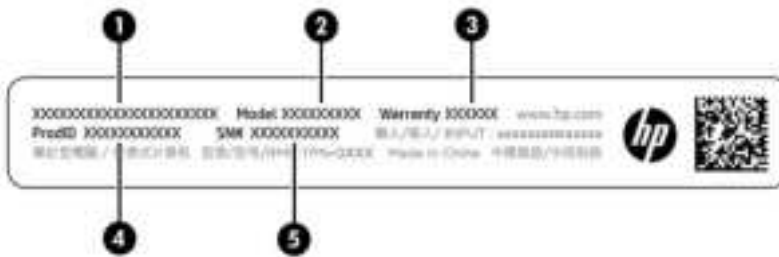

Table 2-11 Service label components

Component	
(1)	HP product name
(2)	Model number
(3)	Warranty period
(4)	Product ID
(5)	Serial number



Table 2-12 Service label component

Component	
Warranty period	

- Regulatory labels—Provide regulatory information about the computer.

- Wireless certification labels—Provide information about optional wireless devices and the approval markings for the countries or regions where the devices have been approved for use.

3 Illustrated parts catalog

Use this chapter to determine the spare parts that are available for the computer.

Computer major components

To identify the computer major components, use this illustration and table.

NOTE: HP continually improves and changes product parts. For complete and current information about supported parts for your computer, go to <http://partsurfer.hp.com>, select your country or region, and then follow the on-screen instructions.

NOTE: Details about your computer, including model, serial number, product key, and length of warranty, are on the service tag at the bottom of your computer.

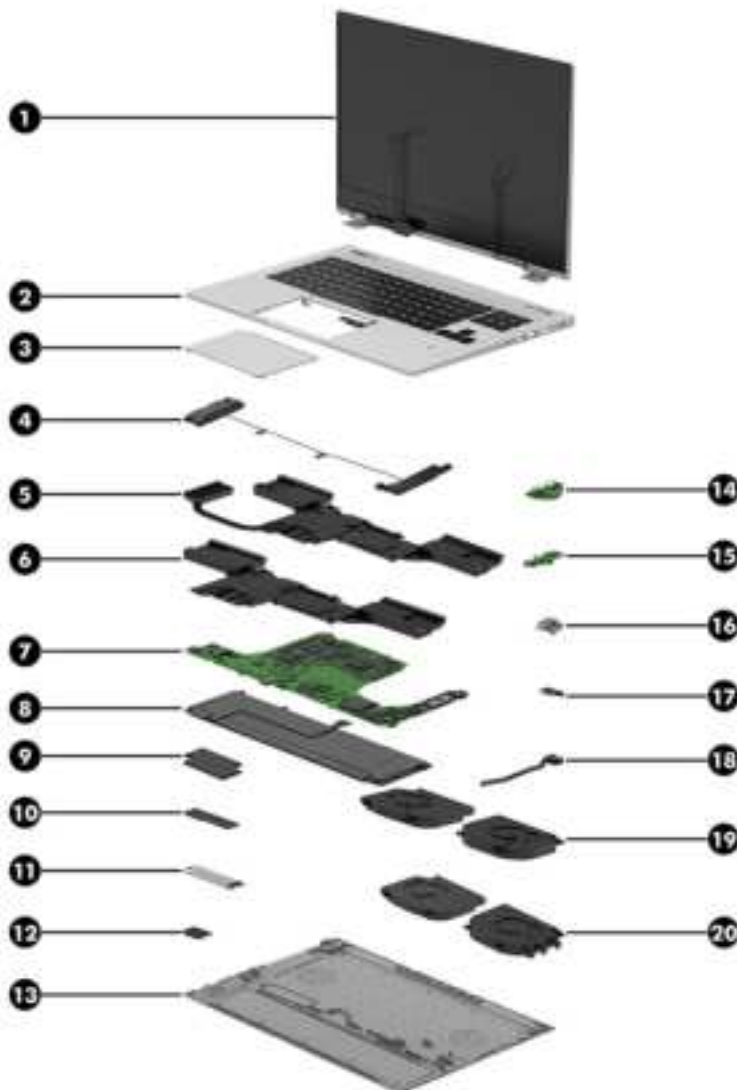

Table 3-1 Computer major component descriptions and part numbers

Item	Component	Spare part number
(1)	Display assembly NOTE: Display spare parts are available only as subcomponents. For spare part information, see Display assembly subcomponents on page 22 .	
(2)	Top cover with keyboard (backlit) NOTE: For a detailed list of country codes, see Top cover with keyboard on page 71 .	
	Aluminum, 4-zone lighting, numeric keypad	N56101-xx1
	Aluminum, 4-zone lighting	N56102-xx1
	Aluminum, 1-zone lighting, numeric keypad	N56103-xx1
	Aluminum, 1-zone lighting	N56104-xx1
	Plastic, 1-zone lighting, models with RTX 4xxx (80 W) graphics	N45350-xx1
	Plastic, 4-zone lighting, models with RTX 4xxx (80 W) graphics	N45347-xx1
(3)	Touchpad NOTE: The touchpad cable is available as spare part number N44747-001 for aluminum models and N44753-001 for plastic models.	
	Plastic	N44780-001
	Aluminum	N44781-001
(4)	Speakers (left and right)	
	For use in plastic models	N44773-001
	For use in aluminum models	N55265-001
	Heat sink	
(5)	For use in aluminum models with 80 W RTX 4xxx graphics and a Ryzen 9 PRO processor	N44893-001
(6)	For use in aluminum models with 60 W RTX 3xxx graphics	N44891-001
	For use in aluminum models with 80 W RTX 4xxx graphics	N44892-001
	For use in plastic models with 80 W RTX 4xxx graphics	N44894-001
(7)	System board NOTE: All system board spare part kits include replacement thermal material. All system boards use the following part numbers: xxxxxx-001: Non-Windows operating systems xxxxxx-601: Windows operating system	
	AMD Ryzen 9 PRO 7940HS processor and RTX 4070 graphics, aluminum models	N44885-xx1
	AMD Ryzen 7 PRO 7840HS processor and RTX 4070 graphics, aluminum models	N44884-xx1
	AMD Ryzen 7 PRO 7840HS processor and RTX 4060 graphics, aluminum models	N44883-xx1
	AMD Ryzen 7 PRO 7840HS processor and RTX 4050 graphics, aluminum models	N44882-xx1
	AMD Ryzen 7 PRO 7840HS processor and RTX 3050 graphics, aluminum models	N44887-xx1
	AMD Ryzen 7 PRO 7840HS processor and RTX 4060 graphics, plastic models	N44880-xx1

Table 3-1 Computer major component descriptions and part numbers (continued)

Item	Component	Spare part number
	AMD Ryzen 7 PRO 7840HS processor and RTX 4050 graphics, plastic models	N44879-xx1
	AMD Ryzen 5 PRO 7640HS processor and RTX 4050 graphics, aluminum models	N44881-xx1
	AMD Ryzen 5 PRO 7640HS processor and RTX 3050 graphics, aluminum models	N44886-xx1
	AMD Ryzen 5 PRO 7640HS processor and RTX 4050 graphics, plastic models	N44878-xx1
(8)	Battery	
	6 cell, 83 Whr	M41711-005
	4 cell, 70 Whr	M39179-005
(9)	Memory module (DDR5-5600)	
	16 GB	N38627-001
	8 GB	N37792-001
(10)	Solid-state drive	
	2 TB	M52027-001
	1 TB	M16560-001
	512 GB	M17436-001
(11)	Solid-state drive cover	not available as a spare part
(12)	WLAN module	
	NOTE: WLAN Mylar is available as spare part number N10779-001.	
	Intel AX211 Wi-Fi 6e Bluetooth 5.2 WLAN	M53366-005
	Realtek 8852CE Wi-Fi 6E Bluetooth 5.3 WLAN	N19618-005
(13)	Bottom cover	
	For use in 80 W plastic models	N44768-001
	For use in 80 W aluminum models	N44769-001
	For use in 60 W aluminum models	N55686-001
(14)	USB board	
	NOTE: The USB board cable is available as spare part number N44749-001 for use in aluminum models and N44750-001 for use in plastic models.	
	For use in plastic models	N44782-001
	For use in aluminum models	N44895-001
(15)	Audio board	
	NOTE: The audio board cable is available as spare part number N44748-001 for use in aluminum models and N44746-001 for use in plastic models.	
	For use in plastic models	N44733-001
	For use in aluminum models	N44734-001
(16)	RJ-45 (network) jack door	

Table 3-1 Computer major component descriptions and part numbers (continued)

Item	Component	Spare part number
	For use in plastic models	N44785-001
	For use in aluminum models	N44786-001
(17)	IR sensor board	N44756-001
	NOTE: The IR sensor board cable is available as spare part number N44745-001.	
(18)	Power connector and cable	N44736-001
(19)	Fan kit, 80 W (models with RTX 4xxx graphics) (includes both processor and graphics fan)	
	For use in aluminum models	N44737-001
	For use in plastic models	N44738-001
(20)	Fan kit, 60 W (models with RTX 3xxx graphics) (includes both processor and graphics fan)	
	For use in aluminum models	N44741-001
*	Hall sensor	N44755-001
	NOTE: The hall sensor cable is available as spare part number N44752-001.	
	* not illustrated	

Display assembly subcomponents

To identify the display assembly subcomponents, use this illustration and table.

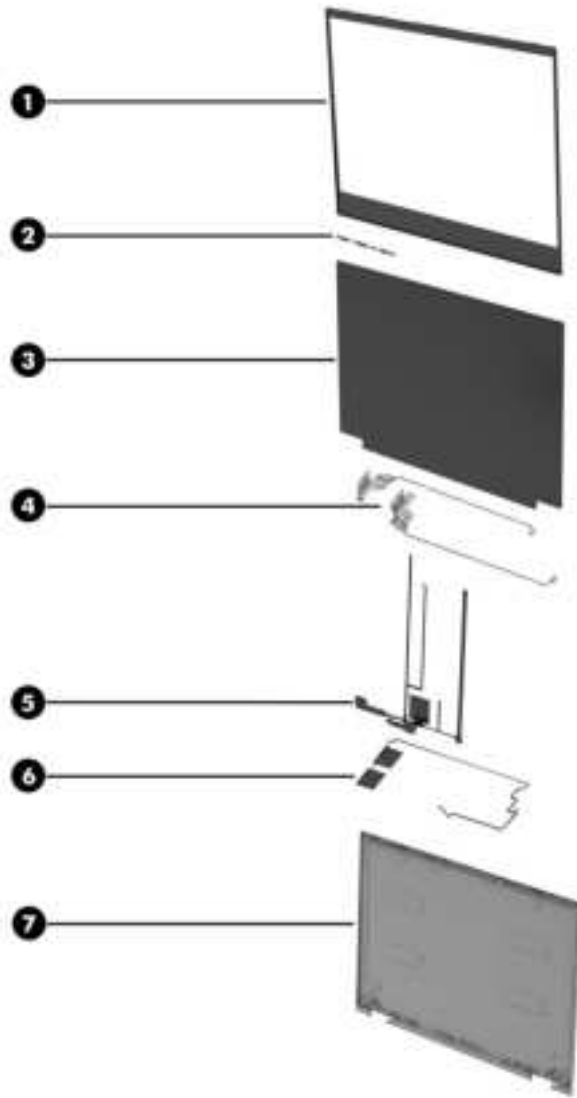

Table 3-2 Display component descriptions and part numbers

Item	Component	Spare part number
(1)	Bezel (includes display adhesive)	
	Aluminum	N44757-001
	Plastic	N44758-001
(2)	Camera module (includes rubber and display and bezel adhesive)	N44735-001
(3)	Display panel (includes display and bezel adhesive)	
	FHD, 250 nits	N44826-001
	FHD, 300 nits	N44827-001
	QHD, 300 nits	N44828-001
(4)	Display hinges (includes left and right hinges and hinge cap rubber inserts; includes display and bezel adhesive)	N44765-001

Table 3-2 Display component descriptions and part numbers (continued)

Item	Component	Spare part number
(5)	Display cable (includes camera cable and ambient light sensor cable; includes display adhesive)	
	For use in aluminum models with a QHD display	N44761-001
	For use in aluminum models with an FHD display	N44762-001
	For use in plastic models with an FHD display	N44763-001
(6)	WLAN antenna kit (includes display adhesive)	
	For use in plastic models	N44730-001
	For use in aluminum models	N44731-001
(7)	Display back cover (includes antennas; includes display adhesive)	
	For use in models with an FHD display	N44759-001
	For use in models with an QHD display	N44923-001
*	Display hinge covers (left and right hinge covers and rubber inserts; includes display and bezel adhesive)	N44764-001
*	Adhesive Kit (includes panel and bezel adhesive)	N44766-001
*not illustrated		

Miscellaneous parts

To identify the miscellaneous parts, use this table.

Table 3-3 Miscellaneous part descriptions and part numbers

Component	Spare part number
AC adapter (PFC)	
280 W	M95376-001
230 W	N22367-001
200 W	N43500-001
Backpack, HP Creator 16.1 inch	N24321-001
USB External DVD+RW drive	747080-001
HDMI-to-VGA adapter	701943-001
USB-C®-to-HDMI 2.0 adapter	935325-001
USB-C-to-USB-A hub	916838-001
HP Elite USB-C Multi Port Hub	L39572-001
USB-C-to-USB 3.0 adapter	814618-001
Adhesive kit (includes display rear cover adhesive and bezel adhesive)	N44766-001
Screw Kit	N44770-001
Power cord (C13, 1.0 m [3.3 ft], premium, straight)	

Table 3-3 Miscellaneous part descriptions and part numbers (continued)

Component	Spare part number
For use in Australia	L22339-001
For use in Denmark	L22334-001
For use in Europe	L22333-001
For use in India	L22343-001
For use in Israel	L22335-001
For use in Italy and Chile	L22103-001
For use in Japan	L22344-001
For use in North America	L22331-001
For use in the People's Republic of China	L22341-001
For use in South Africa	L22337-001
For use in South Korea	L22340-001
For use in Switzerland	L22336-001
For use in Taiwan	L22342-001
For use in Thailand	L22338-001
For use in Thailand (bundle)	M85413-001
For use in the United Kingdom	L22332-001

4 Removal and replacement procedures preliminary requirements

Use this information to properly prepare to disassemble and reassemble the computer.

Tools required

You need the following tools to complete the removal and replacement procedures:

- Tweezers
- Nonconductive, nonmarking pry tool
- Magnetic Phillips P1 screwdriver

Service considerations

The following sections include some of the considerations that you must keep in mind during disassembly and assembly procedures.

 **NOTE:** As you remove each subassembly from the computer, place the subassembly (and all accompanying screws) away from the work area to prevent damage.

Plastic parts

Using excessive force during disassembly and reassembly can damage plastic parts.

Cables and connectors

Handle cables with extreme care to avoid damage.

 **IMPORTANT:** When servicing the computer, be sure that cables are placed in their proper locations during the reassembly process. Improper cable placement can damage the computer.

Apply only the tension required to unseat or seat the cables during removal and insertion. Handle cables by the connector whenever possible. In all cases, avoid bending, twisting, or tearing cables. Be sure that cables are routed so that they cannot be caught or snagged as you remove or replace parts. Handle flex cables with extreme care; these cables tear easily.

Drive handling

Note the following guidelines when handling drives.

 **IMPORTANT:** Drives are fragile components. Handle them with care. To prevent damage to the computer, damage to a drive, or loss of information, observe these precautions:

- Before removing or inserting a hard drive, shut down the computer. If you are unsure whether the computer is off or in Hibernation, turn the computer on, and then shut it down through the operating system.

- Before handling a drive, be sure that you are discharged of static electricity. While handling a drive, avoid touching the connector.
 - Before removing an optical drive, be sure that a disc is not in the drive, and be sure that the optical drive tray is closed.
 - Handle drives on surfaces covered with at least 2.54 cm (1 inch) of shock-proof foam.
 - Avoid dropping drives from any height onto any surface.
 - After removing a hard drive or an optical drive, place it in a static-proof bag.
 - Avoid exposing an internal hard drive to products that have magnetic fields, such as monitors or speakers.
 - Avoid exposing a drive to temperature extremes or liquids.
 - If a drive must be mailed, place the drive in a bubble pack mailer or other suitable form of protective packaging, and label the package "FRAGILE."
-

Electrostatic discharge information

A sudden discharge of static electricity from your finger or other conductor can destroy static-sensitive devices or microcircuitry. Often the spark is neither felt nor heard, but damage occurs. An electronic device exposed to electrostatic discharge (ESD) might not appear to be affected at all and can work perfectly throughout a normal cycle. The device might function normally for a while, but it has been degraded in the internal layers, reducing its life expectancy.

Networks built into many integrated circuits provide some protection, but in many cases, the discharge contains enough power to alter device parameters or melt silicon junctions.

 **IMPORTANT:** To prevent damage to the device when you remove or install internal components, observe these precautions:

- Keep components in their electrostatic-safe containers until you are ready to install them.
 - Before touching an electronic component, discharge static electricity by using the guidelines described in [Personal grounding methods and equipment on page 28](#).
 - Avoid touching pins, leads, and circuitry. Handle electronic components as little as possible.
 - If you remove a component, place it in an electrostatic-safe container.
-

Generating static electricity

Follow these static electricity guidelines:

- Different activities generate different amounts of static electricity.
- Static electricity increases as humidity decreases.

Table 4-1 Static electricity occurrence based on activity and humidity

Event	Relative humidity		
	55%	40%	10%
Walking across carpet	7,500 V	15,000 V	35,000 V
Walking across vinyl floor	3,000 V	5,000 V	12,000 V
Motions of bench worker	400 V	800 V	6,000 V
Removing dual in-line packages (DIPs) from plastic tube	400 V	700 V	2,000 V
Removing DIPs from vinyl tray	2,000 V	4,000 V	11,500 V
Removing DIPs from polystyrene foam	3,500 V	5,000 V	14,500 V
Removing bubble pack from PCB (printed circuit board)	7,000 V	20,000 V	26,500 V
Packing PCBs in foam-lined box	5,000 V	11,000 V	21,000 V
Multiple electric components can be packaged together in plastic tubes, trays, or polystyrene foam.			

 **NOTE:** As little as 700 V of static electricity can degrade a product.

Preventing electrostatic damage to equipment

Many electronic components are sensitive to ESD. Circuitry design and structure determine the degree of sensitivity.

The following packaging and grounding precautions are necessary to prevent static electricity damage to electronic components:

- To avoid hand contact, transport products in static-safe containers such as tubes, bags, or boxes.
- Protect all electrostatic parts and assemblies with conductive or approved containers or packaging.
- Keep electrostatic-sensitive parts in their containers until they arrive at static-free stations.
- Place items on a grounded surface before removing them from their container.
- Always be properly grounded when touching a sensitive component or assembly.
- Avoid contact with pins, leads, or circuitry.
- Place reusable electrostatic-sensitive parts from assemblies in protective packaging or conductive foam.

Personal grounding methods and equipment

Using certain equipment can prevent static electricity damage to electronic components.

- **Wrist straps** are flexible straps with a maximum of 1 M Ω \pm 10% resistance in the ground cords. To provide proper ground, a strap must be worn snug against bare skin. The ground cord must be connected and fit snugly into the banana plug connector on the grounding mat or workstation.
- You can use **heel straps, toe straps, and boot straps** at standing workstations. These straps are compatible with most types of shoes or boots. On conductive floors or dissipative floor mats, use them on both feet with a maximum of 1 M Ω \pm 10% resistance between the operator and ground.

Table 4-2 Static shielding protection levels

Static shielding protection levels	
Method	Voltage
Antistatic plastic	1,500
Carbon-loaded plastic	7,500
Metallized laminate	15,000

Grounding the work area

To prevent static damage at the work area, follow these precautions:

- Cover the work surface with approved static-dissipative material.
- Use a wrist strap connected to a properly grounded work surface and use properly grounded tools and equipment.
- Use static-dissipative mats, foot straps, or air ionizers to give added protection.
- Handle electrostatic sensitive components, parts, and assemblies by the case or PCB laminate. Handle them only at static-free work areas.
- Turn off power and input signals before inserting and removing connectors or test equipment.
- Use fixtures made of static-safe materials when fixtures must directly contact dissipative surfaces.
- Keep the work area free of nonconductive materials, such as ordinary plastic assembly aids and polystyrene foam.
- Use conductive field service tools, such as cutters, screwdrivers, and vacuums.
- Avoid contact with pins, leads, or circuitry.

Recommended materials and equipment

HP recommends certain materials and equipment to prevent static electricity:

- Antistatic tape
- Antistatic smocks, aprons, or sleeve protectors
- Conductive bins and other assembly or soldering aids
- Conductive foam
- Conductive tabletop workstations with ground cord of $1\text{ M}\Omega \pm 10\%$ resistance
- Static-dissipative table or floor mats with hard tie to ground
- Field service kits
- Static awareness labels
- Wrist straps and footwear straps providing $1\text{ M}\Omega \pm 10\%$ resistance
- Material handling packages

- Conductive plastic bags
- Conductive plastic tubes
- Conductive tote boxes
- Opaque shielding bags
- Transparent metallized shielding bags
- Transparent shielding tubes

Cleaning your computer

Cleaning your computer regularly removes dirt and debris so that your device continues to operate at its best. Use the following information to safely clean the external surfaces of your computer.

Enabling HP Easy Clean (select products only)

HP Easy Clean helps you to avoid accidental input while you clean the computer surfaces. This software disables devices such as the keyboard, touch screen, and touchpad for a preset amount of time so that you can clean all computer surfaces.

1. Start HP Easy Clean in one of the following ways:
 - Select the **Start** menu, and then select **HP Easy Clean**.
 - or -
 - Select the **HP Easy Clean** icon in the taskbar.
 - or -
 - Select **Start**, and then select the **HP Easy Clean** tile.
2. Now that your device is disabled for a short period, see [Removing dirt and debris from your computer on page 30](#) for the recommended steps to clean the high-touch, external surfaces on your computer. After you remove the dirt and debris, you can also clean the surfaces with a disinfectant. See [Cleaning your computer with a disinfectant on page 31](#) for guidelines to help prevent the spread of harmful bacteria and viruses.

Removing dirt and debris from your computer

Here are the recommended steps to clean dirt and debris from your computer.

For computers with wood veneer, see [Caring for wood veneer \(select products only\) on page 32](#).

1. Wear disposable gloves made of latex (or nitrile gloves, if you are latex-sensitive) when cleaning the surfaces.
2. Turn off your device and unplug the power cord and other connected external devices. Remove any installed batteries from items such as wireless keyboards.

 **CAUTION:** To prevent electric shock or damage to components, never clean a product while it is turned on or plugged in.

3. Moisten a microfiber cloth with water. The cloth should be moist, but not dripping wet.

 **IMPORTANT:** To avoid damaging the surface, avoid abrasive cloths, towels, and paper towels.

4. Wipe the exterior of the product gently with the moistened cloth.

 **IMPORTANT:** Keep liquids away from the product. Avoid getting moisture in any openings. If liquid makes its way inside your HP product, it can cause damage to the product. Do not spray liquids directly on the product. Do not use aerosol sprays, solvents, abrasives, or cleaners containing hydrogen peroxide or bleach that might damage the finish.

5. Start with the display (if applicable). Wipe carefully in one direction, and move from the top of the display to the bottom. Finish with any flexible cables, like power cord, keyboard cable, and USB cables.
6. Be sure that surfaces have completely air-dried before turning the device on after cleaning.
7. Discard the gloves after each cleaning. Clean your hands immediately after you remove the gloves.

See [Cleaning your computer with a disinfectant on page 31](#) for recommended steps to clean the high-touch, external surfaces on your computer to help prevent the spread of harmful bacteria and viruses.

Cleaning your computer with a disinfectant

The World Health Organization (WHO) recommends cleaning surfaces, followed by disinfection, as a best practice for preventing the spread of viral respiratory illnesses and harmful bacteria.

After cleaning the external surfaces of your computer using the steps in [Removing dirt and debris from your computer on page 30](#), [Caring for wood veneer \(select products only\) on page 32](#), or both, you might also choose to clean the surfaces with a disinfectant. A disinfectant that is within HP's cleaning guidelines is an alcohol solution consisting of 70% isopropyl alcohol and 30% water. This solution is also known as rubbing alcohol and is sold in most stores.

Follow these steps when disinfecting high-touch, external surfaces on your computer:

1. Wear disposable gloves made of latex (or nitrile gloves, if you are latex-sensitive) when cleaning the surfaces.
2. Turn off your device and unplug the power cord and other connected external devices. Remove any installed batteries from items such as wireless keyboards.

 **CAUTION:** To prevent electric shock or damage to components, never clean a product while it is turned on or plugged in.

3. Moisten a microfiber cloth with a mixture of 70% isopropyl alcohol and 30% water. The cloth should be moist, but not dripping wet.

 **CAUTION:** Do not use any of the following chemicals or any solutions that contain them, including spray-based surface cleaners: bleach, peroxides (including hydrogen peroxide), acetone, ammonia, ethyl alcohol, methylene chloride, or any petroleum-based materials, such as gasoline, paint thinner, benzene, or toluene.

 **IMPORTANT:** To avoid damaging the surface, avoid abrasive cloths, towels, and paper towels.

4. Wipe the exterior of the product gently with the moistened cloth.



IMPORTANT: Keep liquids away from the product. Avoid getting moisture in any openings. If liquid makes its way inside your HP product, it can cause damage to the product. Do not spray liquids directly on the product. Do not use aerosol sprays, solvents, abrasives, or cleaners containing hydrogen peroxide or bleach that might damage the finish.

5. Start with the display (if applicable). Wipe carefully in one direction, and move from the top of the display to the bottom. Finish with any flexible cables, like power cord, keyboard cable, and USB cables.
6. Be sure that surfaces have completely air-dried before turning the device on after cleaning.
7. Discard the gloves after each cleaning. Clean your hands immediately after you remove the gloves.

Caring for wood veneer (select products only)

Your product might feature high-quality wood veneer. As with all natural wood products, proper care is important for best results over the life of the product. Because of the nature of natural wood, you might see unique variations in the grain pattern or subtle variations in color, which are normal.

- Clean the wood with a dry, static-free microfiber cloth or chamois.
- Avoid cleaning products containing substances such as ammonia, methylene chloride, acetone, turpentine, or other petroleum-based solvents.
- Do not expose the wood to sun or moisture for long periods of time.
- If the wood becomes wet, dry it by dabbing with an absorbent, lint-free cloth.
- Avoid contact with any substance that might dye or discolor the wood.
- Avoid contact with sharp objects or rough surfaces that might scratch the wood.

See [Removing dirt and debris from your computer on page 30](#) for the recommended steps to clean the high-touch, external surfaces on your computer. After you remove the dirt and debris, you can also clean the surfaces with a disinfectant. See [Cleaning your computer with a disinfectant on page 31](#) for sanitizing guidelines to help prevent the spread of harmful bacteria and viruses.

Packaging and transporting guidelines

Follow these grounding guidelines when packaging and transporting equipment:

- To avoid hand contact, transport products in static-safe tubes, bags, or boxes.
- Protect ESD-sensitive parts and assemblies with conductive or approved containers or packaging.
- Keep ESD-sensitive parts in their containers until the parts arrive at static-free workstations.
- Place items on a grounded surface before removing items from their containers.
- Always be properly grounded when touching a component or assembly.
- Store reusable ESD-sensitive parts from assemblies in protective packaging or nonconductive foam.

- Use transporters and conveyors made of antistatic belts and roller bushings. Be sure that mechanized equipment used for moving materials is wired to ground and that proper materials are selected to avoid static charging. When grounding is not possible, use an ionizer to dissipate electric charges.

Accessing support information

To find the HP support that you need, use this information.

Table 4-3 Support information locations



Service consideration	Path to access information
Records of reported failure incidents stored on the computer	<p>Windows®:</p> <p>Preoperating system failures are logged in the BIOS Event Log. To view the BIOS Event Log:</p> <ol style="list-style-type: none"> 1. Press the power button. 2. Immediately and repeatedly press esc when the power button light turns white. <p>NOTE: If you do not press esc at the appropriate time, you must restart the computer and again repeatedly press esc when the power button light turns white to access the utility.</p> <ol style="list-style-type: none"> 3. Press f10 to enter the BIOS setup. 4. (On commercial products) Under the Main tab, select BIOS event log, and then select View BIOS Event Log. <p>- or -</p> <p>(On consumer products) Under the Main tab, select System Log.</p> <p>Post-operating system failures are logged in the Event Viewer.</p> <ol style="list-style-type: none"> 1. Turn on the computer and allow the operating system to open. 2. Select the search icon  in the taskbar. 3. Type <code>Event Viewer</code>, and then press enter. 4. Select the log from the left panel. Details display in the right panel. <p>Chrome™:</p> <ol style="list-style-type: none"> 1. Go to support.google.com/chrome. 2. Search <code>collect Chrome device logs</code>.
Technical bulletins	<p>To locate technical bulletins:</p> <ol style="list-style-type: none"> 1. Go to www.hp.com. 2. Place the cursor over Problem solving to display more options. 3. Select Support & Troubleshooting. 4. Type the serial number, product number, or product name to go to the product support page. 5. Select Advisories to view technical bulletins.

Table 4-3 Support information locations (continued)

Service consideration	Path to access information
Repair professionals	To locate repair professionals: <ol style="list-style-type: none"><li data-bbox="679 310 906 338">1. Go to www.hp.com.<li data-bbox="679 359 1337 386">2. Place the cursor over Support resources to display more options.<li data-bbox="679 407 1066 434">3. Select Authorized service providers.
Component and diagnosis information, failure detection, and required action	To locate diagnosis information and actions: <ol style="list-style-type: none"><li data-bbox="679 506 1177 533">1. Go to http://www.hp.com/go/techcenter/pcdiags.<li data-bbox="679 554 911 581">2. Select Get Support.<li data-bbox="679 602 1422 653">3. Near the bottom of the window, select Notebook PCs, and then select your location.

5 Removal and replacement procedures for Customer Self-Repair parts

This chapter provides removal and replacement procedures for Customer Self-Repair parts.

 **NOTE:** The Customer Self-Repair program is not available in all locations. Installing a part that is not supported by the Customer Self-Repair program can void your warranty. Check your warranty to determine whether Customer Self-Repair is supported in your location.

Component replacement procedures

To remove and replace computer components, use these procedures.

 **NOTE:** Details about your computer, including model, serial number, product key, and length of warranty, are on the service tag at the bottom of your computer.

 **NOTE:** HP continually improves and changes product parts. For complete and current information about supported parts for your computer, go to <http://partsurfer.hp.com>, select your country or region, and then follow the on-screen instructions.

Make special note of each screw size and location during removal and replacement.

Preparation for disassembly

To remove and replace computer components, use these procedures:

See [Removal and replacement procedures preliminary requirements on page 26](#) for initial safety procedures.

1. Turn off the computer. If you are unsure whether the computer is off or in Hibernation, turn the computer on, and then shut it down through the operating system.
2. Disconnect the power from the computer by unplugging the power cord from the computer.
3. Disconnect all external devices from the computer.

Solid-state drive

To remove the solid-state drive, use this procedure and illustration.

Table 5-1 Solid-state drive descriptions and part numbers

Description	Spare part number
2 TB	M52027-001
1 TB	M16560-001
512 GB	M17436-001

Before removing the solid-state drive, follow these steps:

1. Prepare the computer for disassembly (see [Preparation for disassembly on page 39](#)).
2. Remove the bottom cover (see [Bottom cover on page 39](#)).
3. Disconnect the battery cable from the system board (see [Battery on page 41](#)).

Remove the solid-state drive:

 **NOTE:** Full-feature models can have two solid-state drives. Limited-feature models have one solid-state drive.

1. Remove the two Phillips M2.0 × 2.5 screws (1), and then pull the drive assembly out of the slot (2).

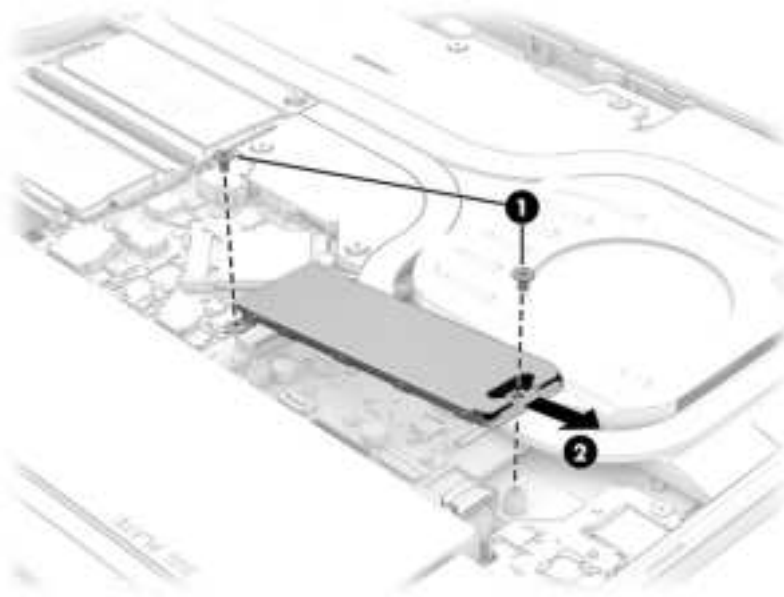

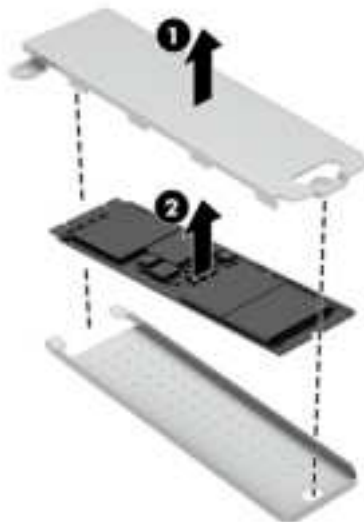

2. Pull the bracket off the top of the drive (1).
3. Lift the top of the drive up slightly, and then pull the drive out of the bottom bracket (2).

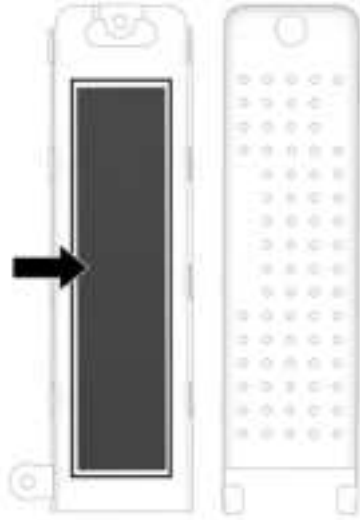

When installing a solid-state drive, first replace the bottom shield drive, install the solid-state drive, and then replace the top bracket.

Be sure a thermal pad is installed on the bottom side of the top bracket.



 **NOTE:** Solid-state drives are designed with a notch to prevent incorrect insertion.

Memory modules

To remove the memory modules, use this procedure and illustration.

Table 5-2 Memory module descriptions and part numbers

Description	Spare part number
Memory module (DDR5-5600)	
16 GB	N38627-001
8 GB	N37792-001

Before removing the memory, follow these steps:

1. Prepare the computer for disassembly (see [Preparation for disassembly on page 39](#)).
2. Remove the bottom cover (see [Bottom cover on page 39](#)).
3. Disconnect the battery cable from the system board (see [Battery on page 41](#)).

If you are replacing a memory module, remove the existing memory module:

1. Lift the protective Mylar that covers the memory modules.
2. Spread the two retention clips outward **(1)** until the memory module tilts up at a 45° angle, and then remove the module **(2)**. Use the same procedure to remove all memory modules.

 **IMPORTANT:** To prevent damage to the memory module, hold the memory module by the edges only. Do not touch the components on the memory module.

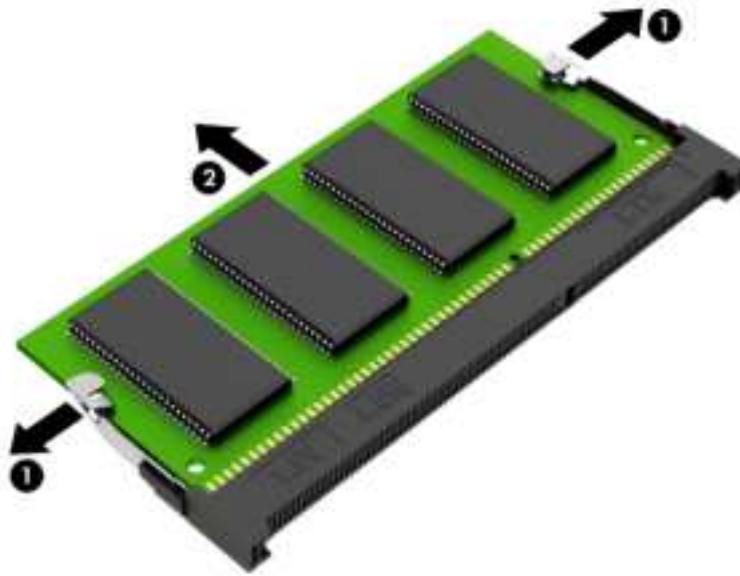

To protect a memory module after removal, place it in an electrostatic-safe container.

To install a memory module:

1. Align the notched edge of the module with the tab in the slot (1), and then press the module into the slot at an angle until it is seated (2).
2. Press down on the module until the side retention clips snap into place (3).

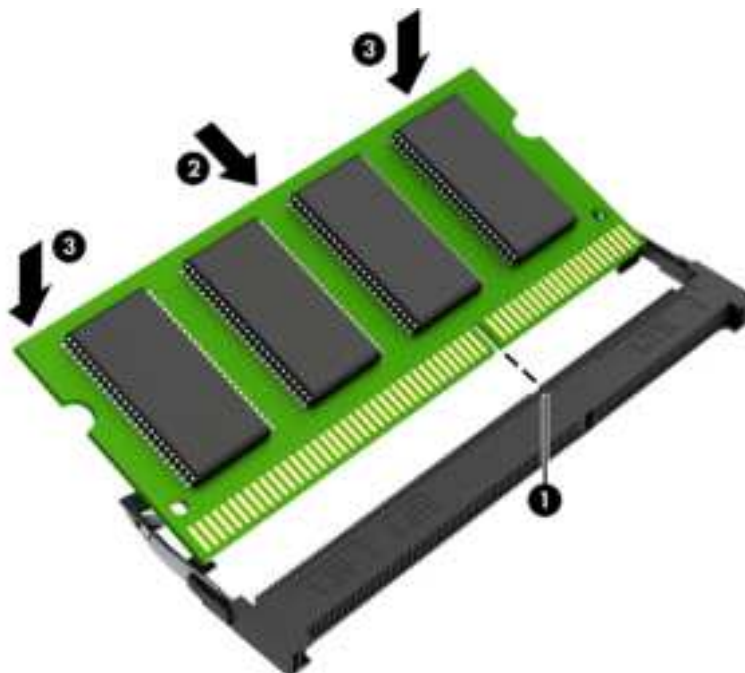

6 Removal and replacement procedures for authorized service provider parts

This chapter provides removal and replacement procedures for authorized service provider parts.

IMPORTANT: Only an authorized service provider should access the components described in this chapter. Accessing these parts can damage the computer or void the warranty.

NOTE: Details about your computer, including model, serial number, product key, and length of warranty, are on the service tag at the bottom of your computer.

Component replacement procedures

To remove and replace computer components, use the procedures described in this section.

NOTE: HP continually improves and changes product parts. For complete and current information about supported parts for your computer, go to <http://partsurfer.hp.com>, select your country or region, and then follow the on-screen instructions.

Make special note of each screw size and location during removal and replacement.

Preparation for disassembly

To remove and replace computer components, use these procedures:

For initial safety procedures, see [Removal and replacement procedures preliminary requirements on page 26](#).

1. Turn off the computer. If you are unsure whether the computer is off or in Hibernation, turn the computer on, and then shut it down through the operating system.
2. Disconnect the power from the computer by unplugging the power cord from the computer.
3. Disconnect all external devices from the computer.

Bottom cover

To remove the bottom cover, use this procedure and illustration.

Table 6-1 Bottom cover description and part number

Description	Spare part number
Bottom cover for use in 80 W plastic models	N44768-001
Bottom cover for use in 80 W aluminum models	N44769-001
Bottom cover for use in 60 W aluminum models	N55686-001
RJ-45 door for use in plastic models	N44785-001
RJ-45 door for use in aluminum models	N44786-001

Before removing the bottom cover, prepare the computer for disassembly (see [Preparation for disassembly on page 39](#)).

Remove the bottom cover:

1. Remove the two Phillips M2.5 × 6.0 screws **(1)** and the six Phillips M2.5 × 3.0 screws **(2)** that secure the bottom cover to the computer.

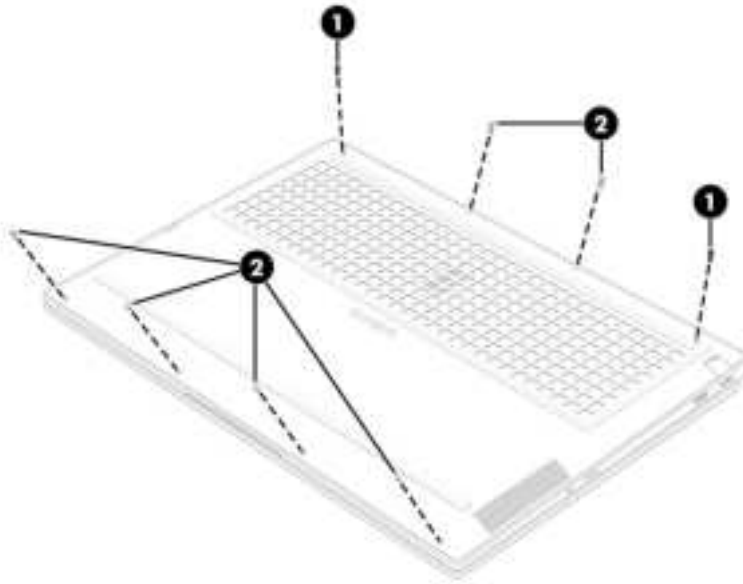

2. Open the computer and position it with the display on the table.
3. Push the top cover just below the keyboard **(1)** to release the bottom cover, and then insert a tool **(2)** into the gap to remove the cover **(3)**.



4. To remove the RJ-45 door from the bottom cover, remove the two Phillips M2.0 × 3.6 screws (1), remove the bracket (2) and spring (3), and then remove the door (4).

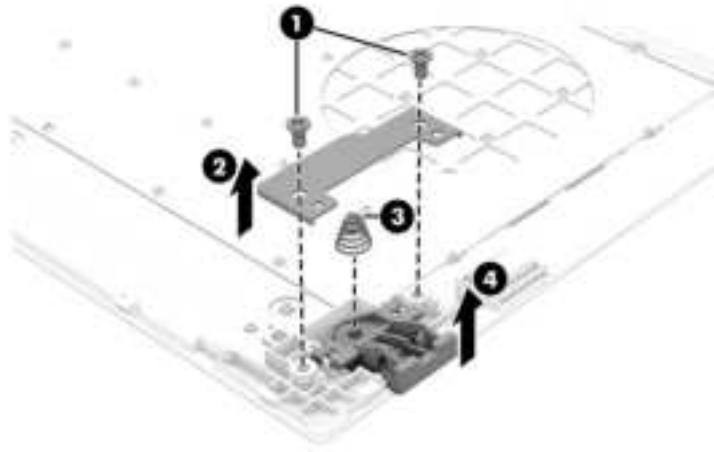

 **NOTE:** On full-feature models, the RJ-45 door is on the back of the computer.

To replace the bottom cover, reverse the removal procedures.

Battery

To remove the battery, use this procedure and illustration.

Table 6-2 Battery description and part number

Description	Spare part number
6 cell, 83 Whr	M41711-005
4 cell, 70 Whr	M39179-005

 **WARNING!** To avoid personal injury and damage to the product:

- Do *not* puncture, twist, or crack the battery.
- Do *not* cause an external puncture or rupture to the battery. Punctures and ruptures can cause a short inside the battery, which can result in battery thermal runaway.
- Do *not* handle or touch the battery enclosure with sharp objects such as tweezers or pliers, which might puncture the battery.
- Do *not* compress or squeeze the battery case with tools or heavy objects stacked on top of the case. These actions can apply undue force on the battery.
- Do *not* touch the connectors with any metallic surface or object, such as metal tools, screws, or coins, which can cause shorting across the connectors.

Before removing the battery, follow these steps:

1. Prepare the computer for disassembly (see [Preparation for disassembly on page 39](#)).
2. Remove the bottom cover (see [Bottom cover on page 39](#)).

- ⚠ **WARNING!** To reduce potential safety issues, use only the user-replaceable battery provided with the computer, a replacement battery provided by HP, or a compatible battery purchased from HP.
- 📄 **IMPORTANT:** Removing a battery that is the sole power source for the computer can cause loss of information. To prevent loss of information, save your work or shut down the computer through Windows before you remove the battery.

Remove the battery:

1. Disconnect the battery cable (1) from the system board.
2. Remove the six Phillips M2.0 × 4.5 screws (2) that secure the battery to the computer.
3. Remove the battery (3).

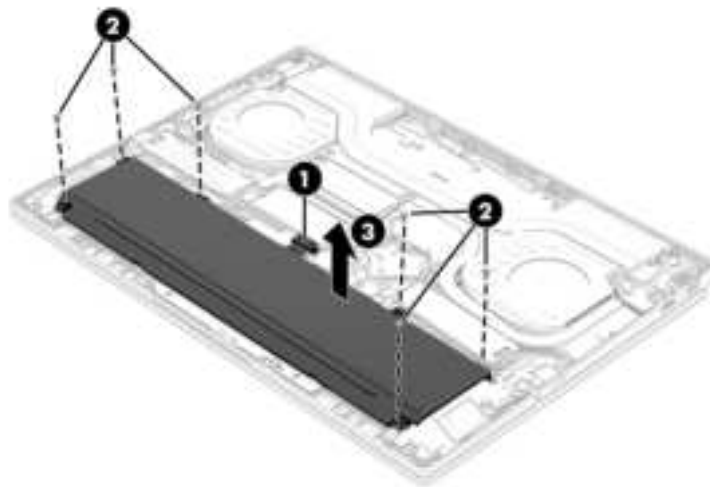

To install the battery, reverse the removal procedures.

WLAN module, limited-feature models

To remove the WLAN module, use this procedure and illustration.

Table 6-3 WLAN module descriptions and part numbers

Description	Spare part number
Intel AX211 Wi-Fi 6E Bluetooth 5.3 WLAN	M53366-005
Realtek 8852CE Wi-Fi 6E Bluetooth 5.3 WLAN	N19618-005
WLAN Mylar	N10779-001

- 📄 **IMPORTANT:** To prevent an unresponsive system, replace the wireless module only with a wireless module authorized for use in the computer by the governmental agency that regulates wireless devices in your country or region. If you replace the module and then receive a warning message, remove the module to restore device functionality, and then contact technical support.

Before removing the WLAN module, follow these steps:

1. Prepare the computer for disassembly (see [Preparation for disassembly on page 39](#)).

2. Remove the bottom cover (see [Bottom cover on page 39](#)).
3. Disconnect the battery cable from the system board (see [Battery on page 41](#)).

Remove the WLAN module:

1. Remove the Mylar protector that covers the antennas **(1)**.
2. Carefully disconnect the antenna cables from the module **(2)**.
3. Remove the Phillips M2.0 × 2.5 screw **(3)**.
4. Pull the module out of the socket to remove it **(4)**.

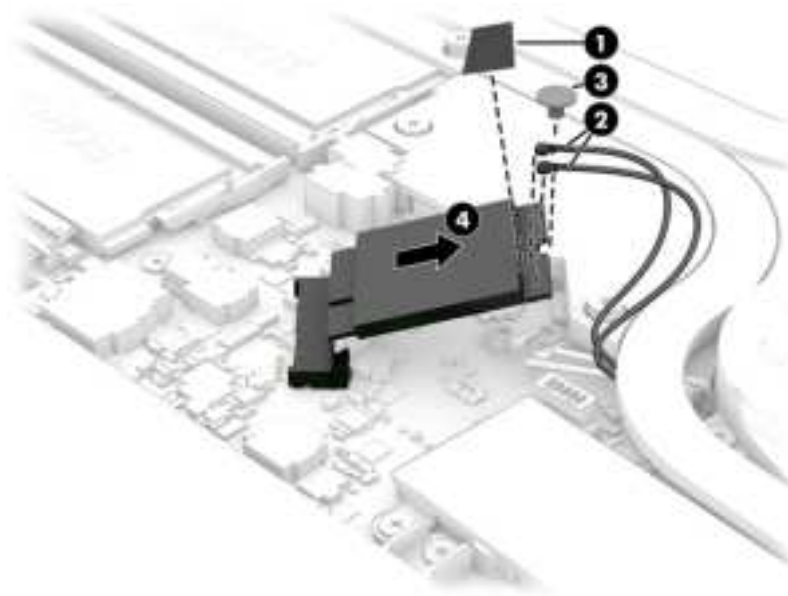

5. If the WLAN antenna is not connected to the terminal on the WLAN module, install a protective sleeve on the antenna connector, as shown in the following illustration.

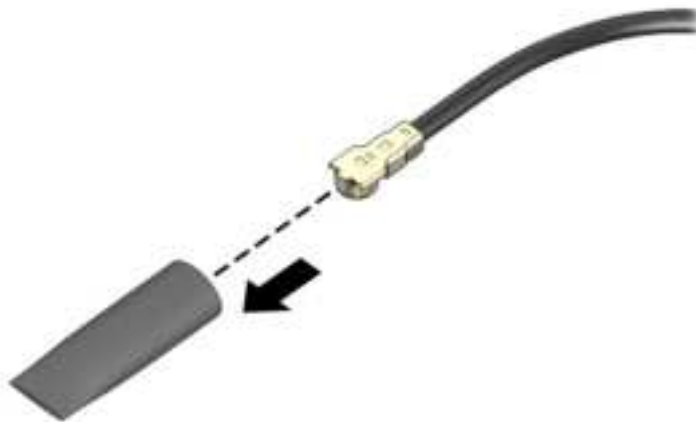

To install the WLAN module, reverse this procedure.

WLAN module, full-feature models

To remove the WLAN module, use this procedure and illustration.

Table 6-4 WLAN module descriptions and part numbers

Description	Spare part number
Intel AX211 Wi-Fi 6E Bluetooth 5.3 WLAN	M53366-005
Realtek 8852CE Wi-Fi 6E Bluetooth 5.3 WLAN	N19618-005
WLAN Mylar	N10779-001

IMPORTANT: To prevent an unresponsive system, replace the wireless module only with a wireless module authorized for use in the computer by the governmental agency that regulates wireless devices in your country or region. If you replace the module and then receive a warning message, remove the module to restore device functionality, and then contact technical support.

Before removing the WLAN module, follow these steps:

1. Prepare the computer for disassembly (see [Preparation for disassembly on page 39](#)).
2. Remove the bottom cover (see [Bottom cover on page 39](#)).
3. Disconnect the battery cable from the system board (see [Battery on page 41](#)).

Remove the WLAN module:

1. Remove the Mylar protector that covers the antennas (1).
2. Carefully disconnect the antenna cables from the module (2).
3. Remove the Phillips M2.0 × 2.5 screw (3).
4. Pull the module out of the socket to remove it (4).

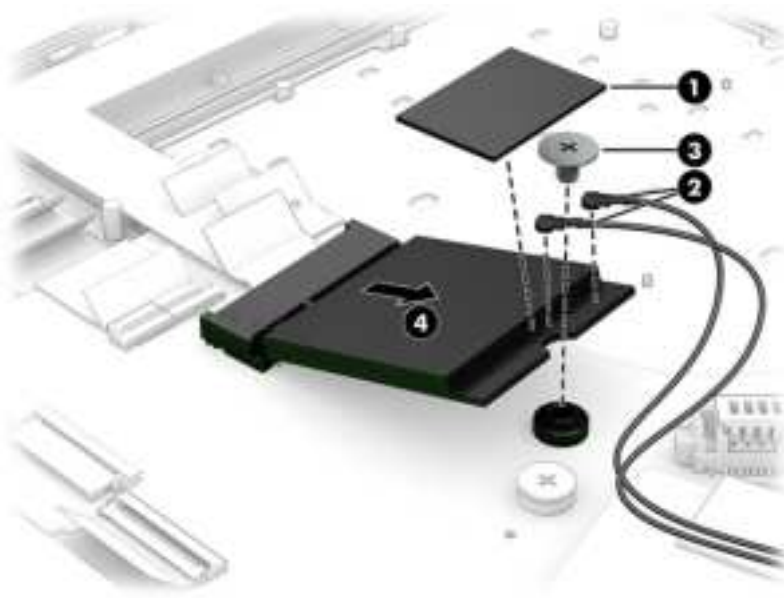

5. If the WLAN antenna is not connected to the terminal on the WLAN module, install a protective sleeve on the antenna connector, as shown in the following illustration.

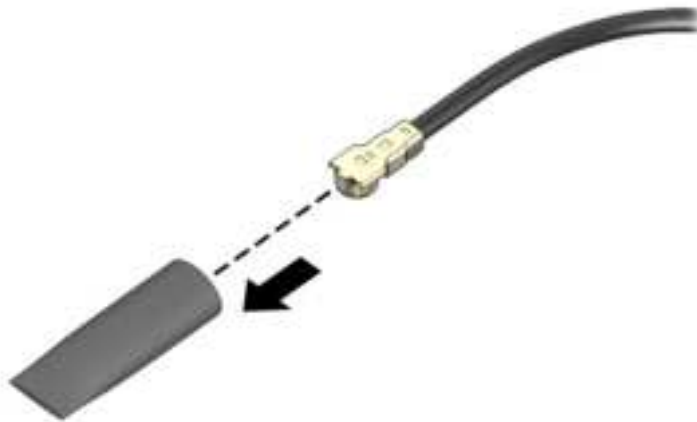

To install the WLAN module, reverse this procedure.

Speakers

To remove the speakers, use this procedure and illustration.

Table 6-5 Speaker description and part number

Description	Spare part number
For use in plastic models	N44773-001
For use in aluminum models	N55265-001

Before removing the speakers, follow these steps:

1. Prepare the computer for disassembly (see [Preparation for disassembly on page 39](#)).
2. Remove the bottom cover (see [Bottom cover on page 39](#)).
3. Remove the battery (see [Battery on page 41](#)).
4. On limited-feature models, remove the solid-state drive (see [Solid-state drive on page 35](#)).

Remove the speakers:

1. Disconnect the speaker cable from the system board **(1)**.
2. Remove the speaker cable from the clips along the bottom of the computer **(2)**.
3. Remove the two broadhead Phillips M1.6 × 3.0 screws **(3)** that secure each speaker to the computer.

4. Remove the speakers from the computer (4).

 **NOTE:** When removing the speakers, make note of the location of the rubber isolators (5). The absence of or damage to these isolators can result in degraded speaker performance.

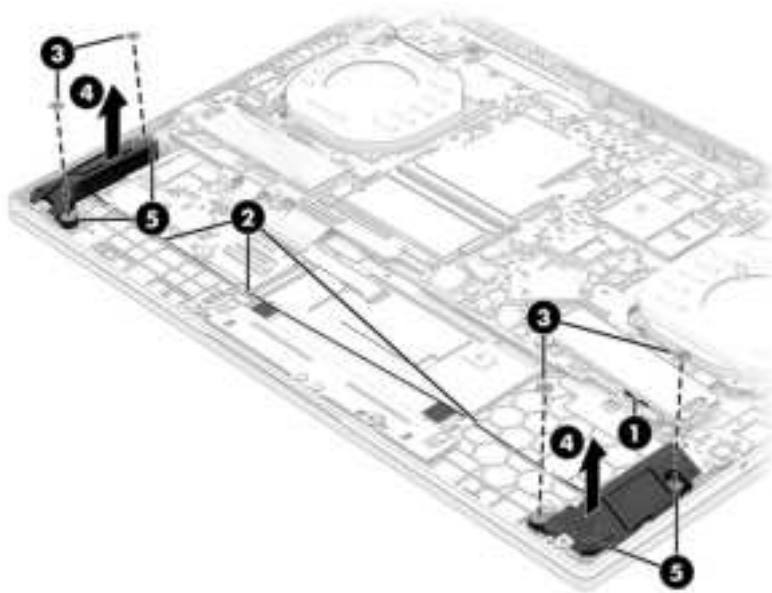

To install the speakers, reverse this procedure.

Fans, limited-feature models

To remove the fans, use this procedure and illustration.

Table 6-6 Fan descriptions and part numbers

Description	Spare part number
Fan kit, 80 W (models with RTX 4xxx graphics) (includes both fans)	N44738-001

Before removing the fans, follow these steps:

1. Prepare the computer for disassembly (see [Preparation for disassembly on page 39](#)).
2. Remove the bottom cover (see [Bottom cover on page 39](#)).
3. Disconnect the battery cable from the system board (see [Battery on page 41](#)).

Remove the fans:

1. Disconnect the fan cables from the system board (1).
2. Remove the three Phillips M2.0 × 3.5 screws (2) that secure each fan to the computer.

3. Remove the fans **(3)**.

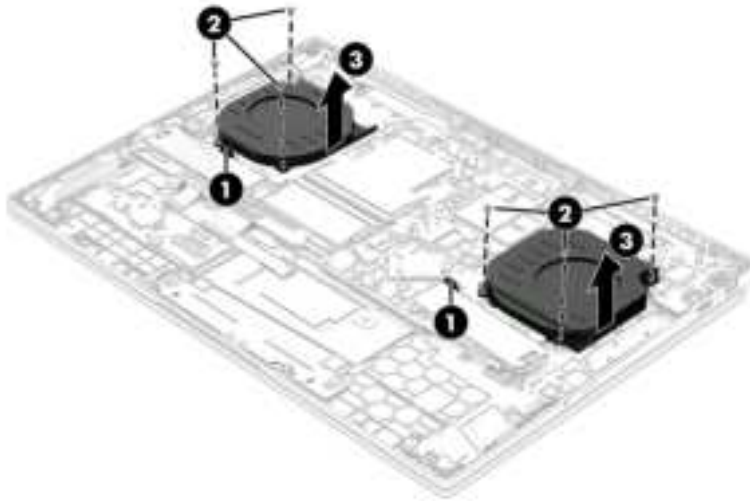

To install the fans, reverse this procedure.

USB board, full-feature models

To remove the USB board, use this procedure and illustration.

Table 6-7 USB board description and part number

Description	Spare part number
USB board for use in aluminum models	N44895-001
USB board cable for use in aluminum models	N44749-001

Before removing the USB board, follow these steps:

1. Prepare the computer for disassembly (see [Preparation for disassembly on page 39](#)).
2. Remove the bottom cover (see [Bottom cover on page 39](#)).
3. Disconnect the battery cable from the system board (see [Battery on page 41](#)).

Remove the USB board:

1. Disconnect the cable from the ZIF connector **(1)** on the USB board.
2. Remove the two Phillips M2.0 × 3.5 screws **(2)** that secure the board to the computer.

3. Remove the board (3).

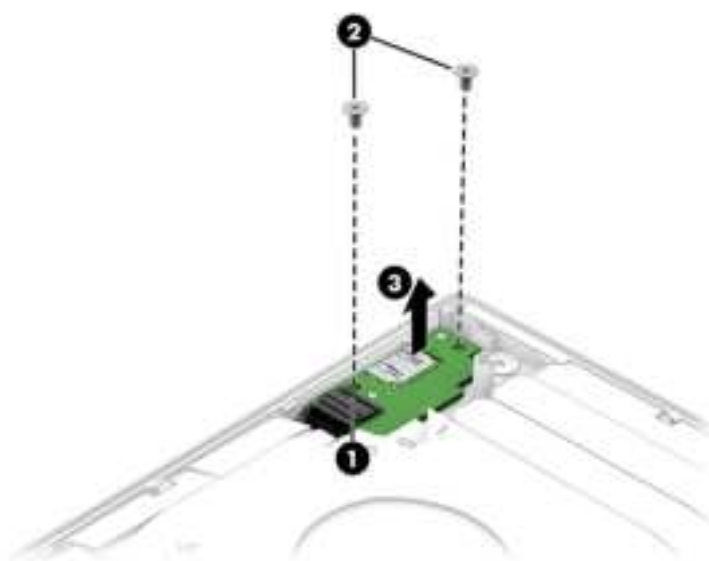

To install the USB board, reverse this procedure.

Heat sink assembly

To remove the heat sink assembly, use this procedure and illustration.

Table 6-8 Heat sink description and part number

Description	Spare part number
For use in aluminum models with 80 W RTX 4xxx graphics and a Ryzen 9 PRO processor	N44893-001
For use in aluminum models with 60 W RTX 3xxx graphics	N44891-001
For use in aluminum models with 80 W RTX 4xxx graphics	N44892-001
For use in plastic models with 80 W RTX 4xxx graphics	N44894-001

 **NOTE:** You do not have to remove the heat sink before you remove the system board.

Before removing the heat sink assembly, follow these steps:

1. Prepare the computer for disassembly (see [Preparation for disassembly on page 39](#)).
2. Remove the bottom cover (see [Bottom cover on page 39](#)).
3. Disconnect the battery cable from the system board (see [Battery on page 41](#)).

Remove the heat sink assembly:

1. In the order indicated on the heat sink, loosen the seven captive Phillips screws (1).
2. Remove the heat sink (2).

Models with 80 W RTX 4xxx graphics and A9 processors

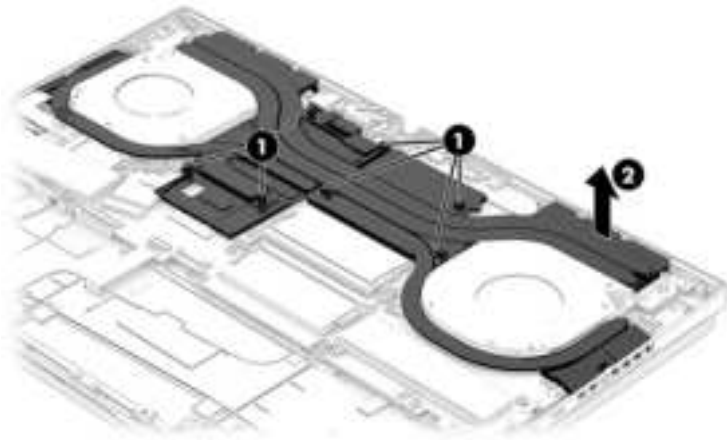

Models with 80 W RTX 4xxx graphics

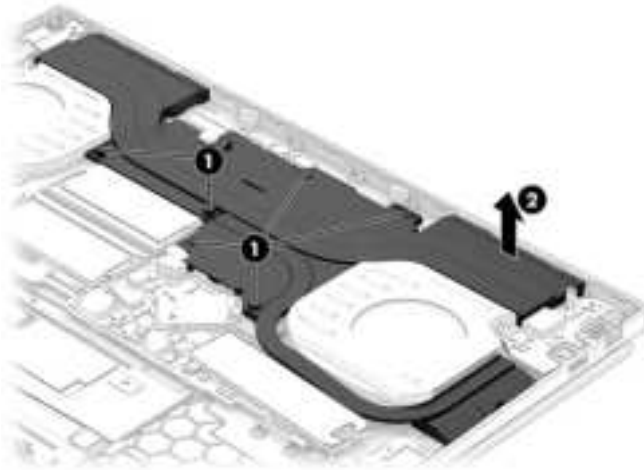

Models with 60 W RTX 3xxx graphics

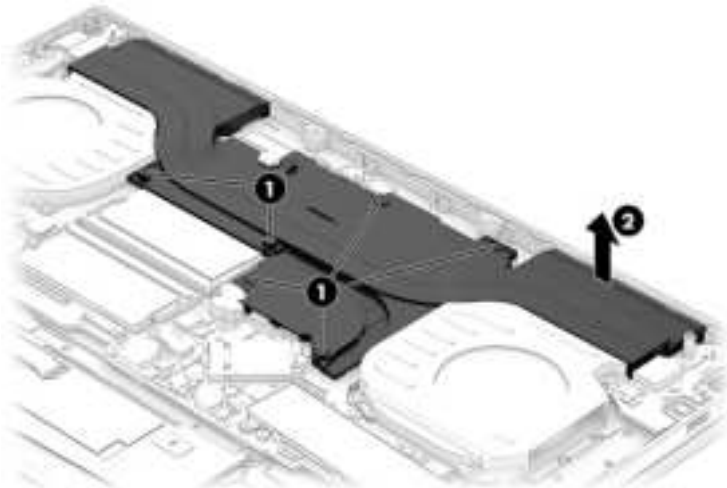

To install the heat sink, reverse this procedure.

USB board, limited-feature models

To remove the USB board, use this procedure and illustration.

Table 6-9 USB board description and part number

Description	Spare part number
USB board	N44782-001
USB board cable	N44750-001

Before removing the USB board, follow these steps:

1. Prepare the computer for disassembly (see [Preparation for disassembly on page 39](#)).
2. Remove the bottom cover (see [Bottom cover on page 39](#)).
3. Remove the battery (see [Battery on page 41](#)).
4. Remove the fans (see [Fans, limited-feature models on page 46](#)).

Remove the USB board:

1. Remove the two Phillips M2.0 × 3.5 screws (1) that secure the board to the computer.
2. Lift and turn the board upside down (2).
3. Disconnect the cable from the ZIF connector (3) on the bottom of the board.

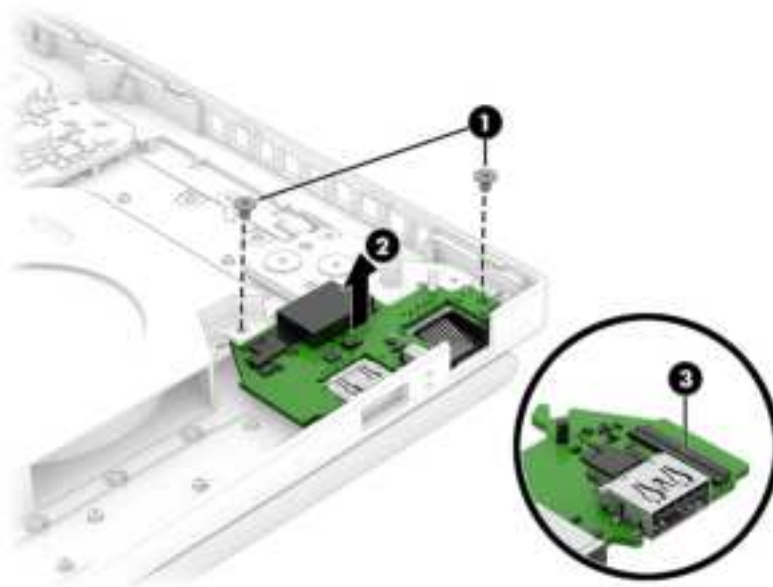

To install the USB board, reverse this procedure.

System board with heat sink

To remove the system board with heat sink, use these procedures and illustrations.

Table 6-10 System board descriptions and part numbers

Description	Spare part number
All system boards use the following part numbers:	
xxxxxx-001: Non-Windows operating systems	
xxxxxx-601: Windows operating system	
AMD Ryzen 9 PRO 7940HS processor and RTX 4070 graphics, aluminum models	N44885-xx1
AMD Ryzen 7 PRO 7840HS processor and RTX 4070 graphics, aluminum models	N44884-xx1
AMD Ryzen 7 PRO 7840HS processor and RTX 4060 graphics, aluminum models	N44883-xx1
AMD Ryzen 7 PRO 7840HS processor and RTX 4050 graphics, aluminum models	N44882-xx1
AMD Ryzen 7 PRO 7840HS processor and RTX 3050 graphics, aluminum models	N44887-xx1
AMD Ryzen 7 PRO 7840HS processor and RTX 4060 graphics, plastic models	N44880-xx1
AMD Ryzen 7 PRO 7840HS processor and RTX 4050 graphics, plastic models	N44879-xx1
AMD Ryzen 5 PRO 7640HS processor and RTX 4050 graphics, aluminum models	N44881-xx1
AMD Ryzen 5 PRO 7640HS processor and RTX 3050 graphics, aluminum models	N44886-xx1
AMD Ryzen 5 PRO 7640HS processor and RTX 4050 graphics, plastic models	N44878-xx1

 **NOTE:** You do not have to remove the heat sink before you remove the system board.

Before removing the system board, follow these steps:

1. Prepare the computer for disassembly (see [Preparation for disassembly on page 39](#)).
2. Remove the bottom cover (see [Bottom cover on page 39](#)).
3. Remove the battery (see [Battery on page 41](#)).

When you replace the system board, be sure to remove the following components (as applicable) from the defective system board and install them on the replacement system board:

- Solid-state drive (see [Solid-state drive on page 35](#)).
- Memory modules (see [Memory modules on page 37](#)).
- WLAN module (see [WLAN module, limited-feature models on page 42](#)).

Full-feature models

Remove the system board from full-feature models:

1. Disconnect the following cables from the system board:
 - IR sensor board **(1)**
 - Display cable **(2)** (ZIF)
 - Speaker cable **(3)**
 - Audio board cable (ZIF) **(4)**

- Left fan cable (5)
- Touchpad cable (ZIF) (6)
- Keyboard cable (ZIF) (7)
- Right fan cable (8)
- Wireless antenna cables from the WLAN module (9)
- Four-zone backlight cable (ZIF) (10)
- USB board cable (ZIF) (11)

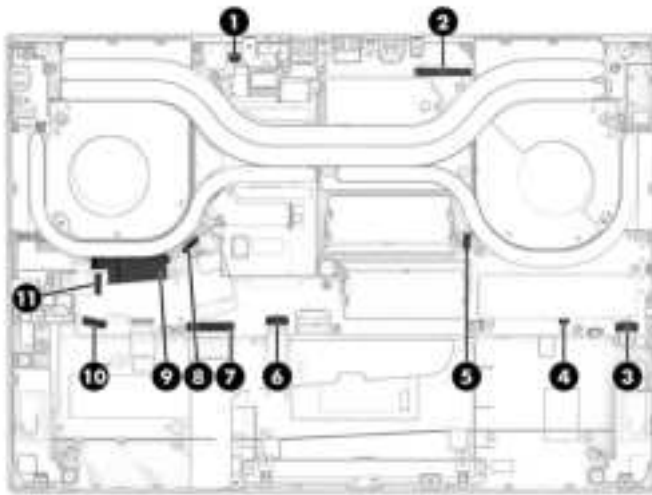

2. Remove the nine Phillips M2.0 × 3.5 screws from the system board.



3. Lift the right side of the system board (1), and then pull the system board to the right to remove it (2). The bracket at the top of the system board might separate from the board (3) when you remove it.

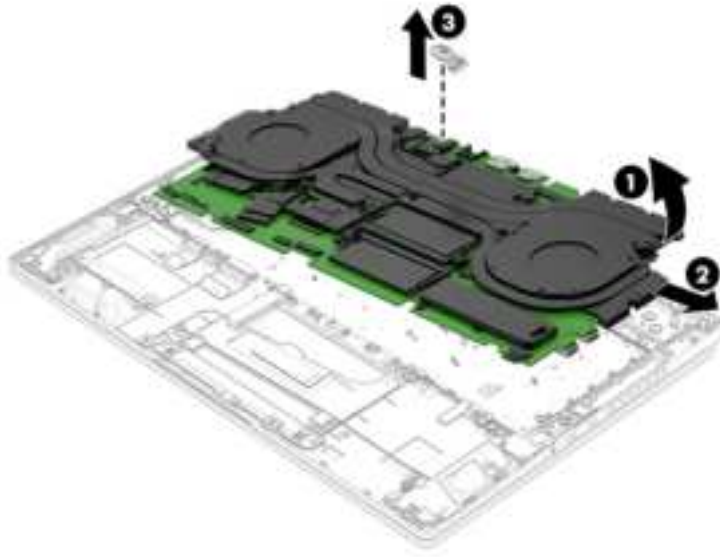

Limited-feature models

Remove the system board from limited-feature models:

1. Disconnect the following cables from the system board:
 - Display cable (ZIF) **(1)**
 - IR board cable (ZIF) **(2)**
 - USB/RJ-45 board cable **(3)**
 - Audio board cable (ZIF) **(4)**
 - Left fan cable **(5)**
 - Wireless antenna cables from the WLAN module **(6)**
 - Keyboard cable **(7)**
 - Right fan cable **(8)**
 - Touchpad cable (ZIF) **(9)**
 - Four-zone backlight cable (ZIF) **(10)**
 - Power connector cable (ZIF) **(11)**
 - One-zone backlight cable (ZIF) **(12)**

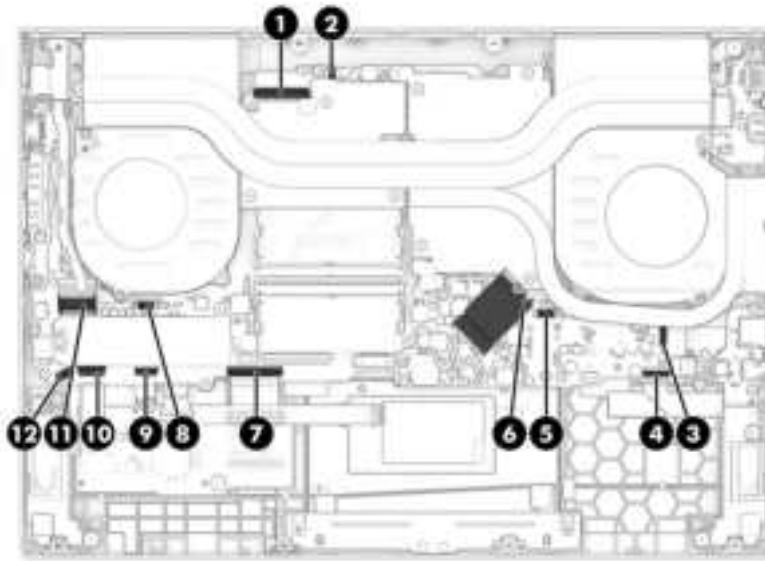

2. Remove the 11 Phillips M2.0 × 3.5 screws from the system board.

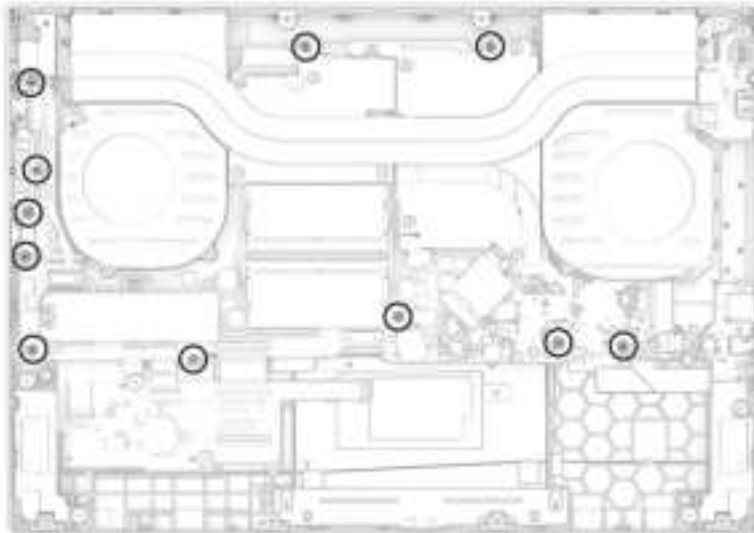

3. Lift the right side of the system board (1), and then pull the system board to the right to remove it (2). The USB port bracket might separate from the board (3) when you remove it.

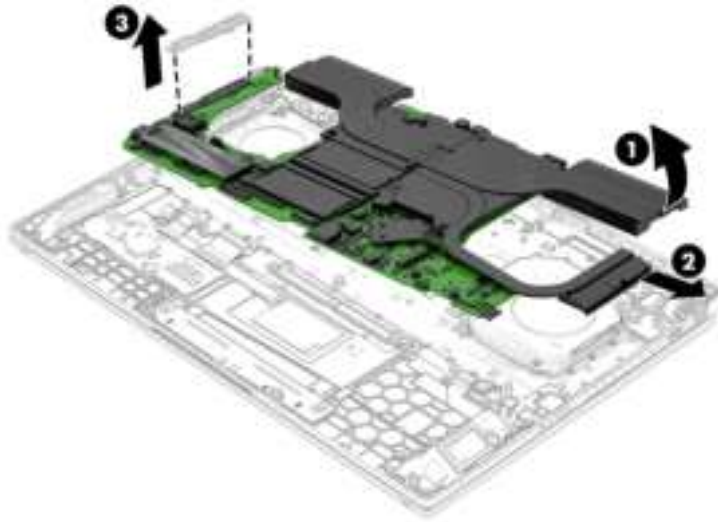

4. If you are replacing the system board, you must remove the heat sink from the old system board and install it on the new system board. The following illustrations show replacement thermal material locations.

NOTE: The heat sink comes with thermal material preapplied. You only need to replace thermal material when the heat sink is reused. The thermal pad should be reusable.

Thoroughly clean and replace the thermal paste and gel from the surfaces on the system board components each time the heat sink is removed. The thermal pads are reusable. Be sure that gray thermal grease (1), white thermal gel (gap filler) (2), and thermal pads (3) are installed on the system board as shown in the following illustrations.

Full-feature models with the following 80 W graphics cards: RTX 4080

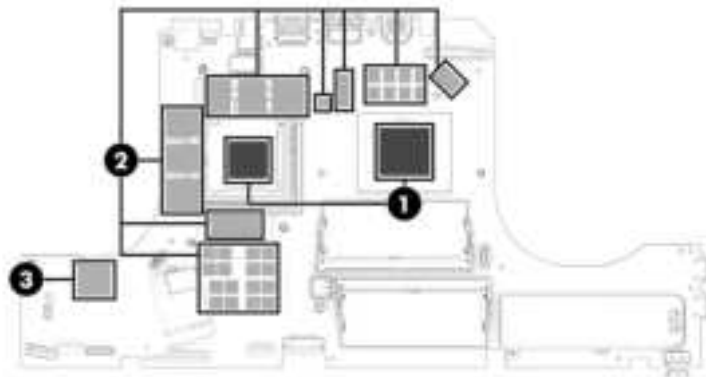

Full-feature models with the following 80 W graphics card: RTX 4050/4060/4070

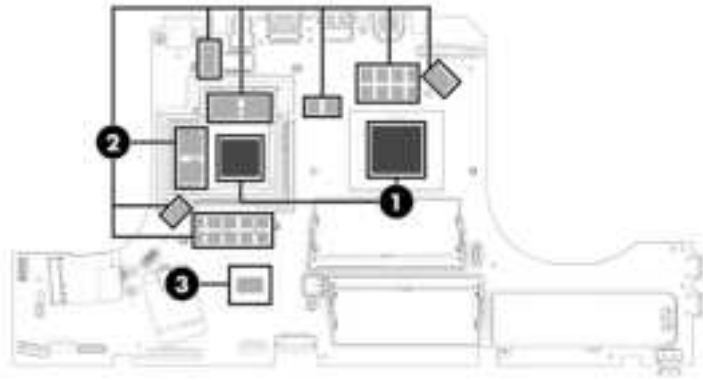

Full-feature models with a 60 W graphics card

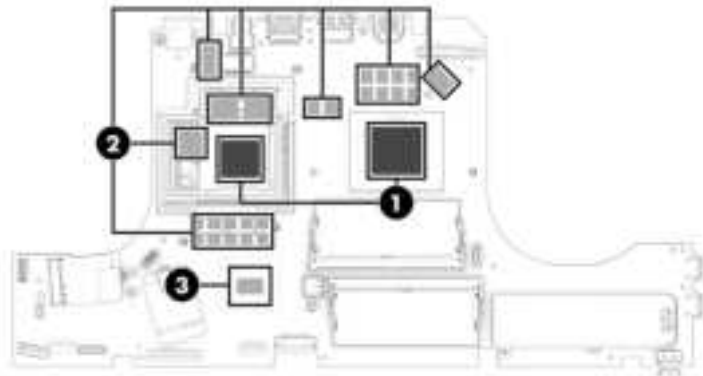

Thoroughly clean and replace the thermal paste from the surfaces on the system board components each time the heat sink is removed. The thermal pads are reusable. Be sure that gray thermal grease (1) and thermal gel (2) are installed on the system board as shown in the following illustration.

Limited-feature models with an 80 W graphics card



To install the system board, reverse this procedure.

IR board

To remove the IR board, use this procedure and illustration.

Table 6-11 IR board description and part number

Description	Spare part number
IR board	N44756-001
IR board cable	N44745-001

Before removing the IR board, follow these steps:

1. Prepare the computer for disassembly (see [Preparation for disassembly on page 39](#)).
2. Remove the bottom cover (see [Bottom cover on page 39](#)).
3. Remove the battery (see [Battery on page 41](#)).
4. Remove the system board (see [System board with heat sink on page 50](#)).

Remove the IR board:

- Remove the Phillips M2.0 × 2.0 screw that secures the board to the computer **(1)**, and then remove the board **(2)**.

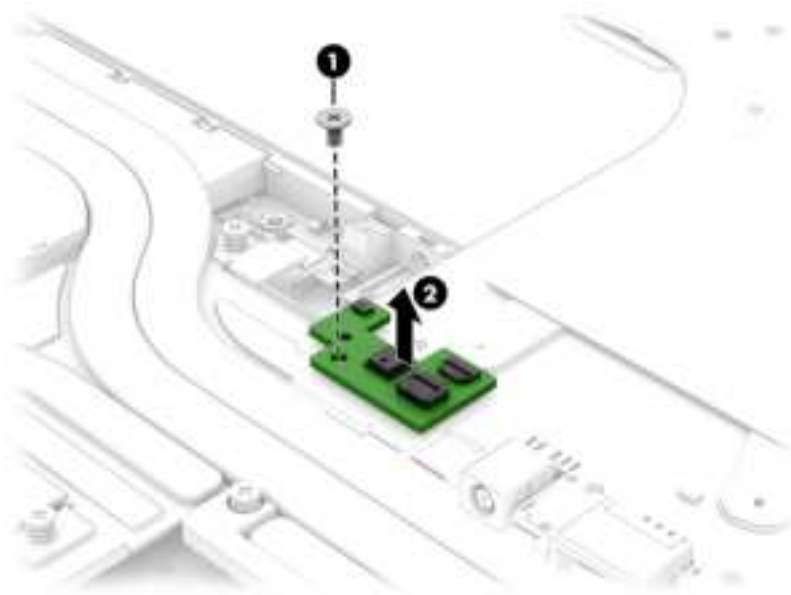

To install the IR board, reverse this procedure.

Audio board, full-feature models

To remove the audio board, use this procedure and illustration.

Table 6-12 Audio board description and part number

Description	Spare part number
Audio board	N44734-001
Audio board cable	N44748-001

Before removing the audio board, follow these steps:

1. Prepare the computer for disassembly (see [Preparation for disassembly on page 39](#)).
2. Remove the bottom cover (see [Bottom cover on page 39](#)).
3. Remove the battery (see [Battery on page 41](#)).
4. Remove the system board with heat sink (see [System board with heat sink on page 50](#)).

Remove the audio board:

1. Disconnect the cable from the ZIF connector **(1)** on the audio board.
2. Remove the two Phillips M2.0 × 3.5 screws **(2)** that secure the board to the computer.
3. Lift back of board up, and then pull board into the computer to remove it **(3)**.

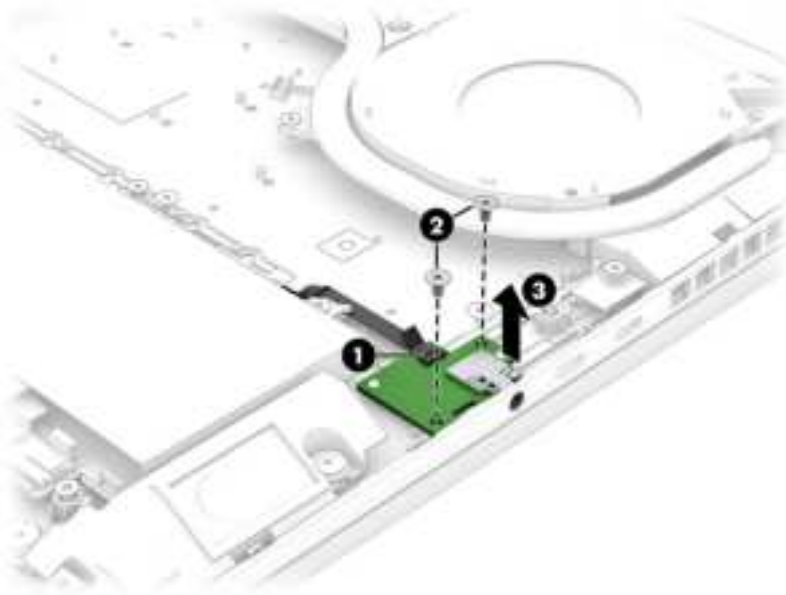

To install the audio board, reverse this procedure.

Audio board, limited-feature models

To remove the audio board, use this procedure and illustration.

Table 6-13 Audio board description and part number

Description	Spare part number
Audio board	N44733-001
Audio board cable	N44746-001

Before removing the audio board, follow these steps:

1. Prepare the computer for disassembly (see [Preparation for disassembly on page 39](#)).
2. Remove the bottom cover (see [Bottom cover on page 39](#)).

3. Remove the battery (see [Battery on page 41](#)).
4. Remove the left speaker (see [Speakers on page 45](#)).

Remove the audio board:

1. Remove the two Phillips M2.0 × 3.5 screws (1) that secure the board to the computer.
2. Lift back of board up, and then turn the board upside down (2).
3. Remove the tape from the connector on the bottom of the board (3).
4. Disconnect the cable from the ZIF connector (4) on the bottom of the board.

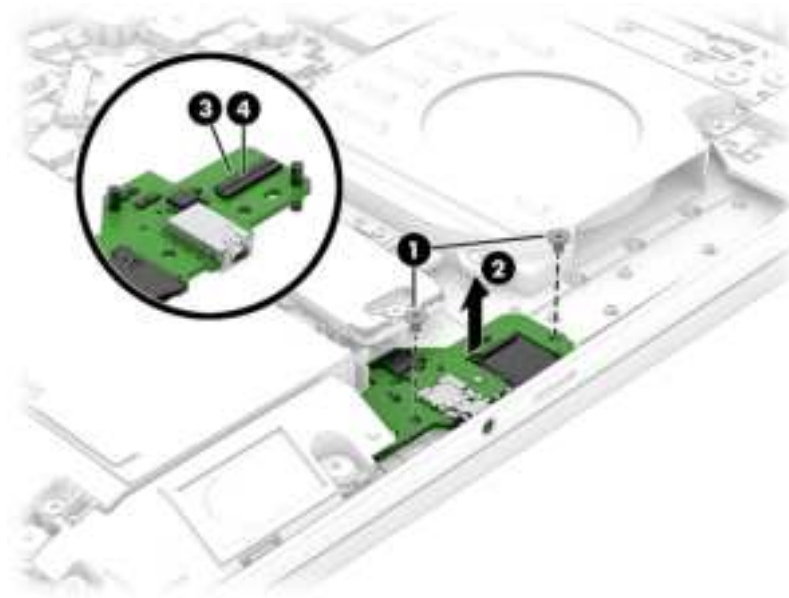

To install the audio board, reverse this procedure.

Touchpad

To remove the touchpad, use this procedure and illustration.

Table 6-14 Touchpad description and part number

Description	Spare part number
Touchpad for use in plastic models	N44780-001
Touchpad for use in aluminum models	N44781-001
Touchpad cable for use in plastic models	N44753-001
Touchpad cable for use in aluminum models	N44747-001

Before removing the touchpad, follow these steps:

1. Prepare the computer for disassembly (see [Preparation for disassembly on page 39](#)).
2. Remove the bottom cover (see [Bottom cover on page 39](#)).

3. Remove the battery (see [Battery on page 41](#)).

Remove the touchpad:

1. Remove the four Phillips M2.0 × 2.5 screws **(1)** that secure the touchpad bracket to the computer, and then remove the bracket **(2)**.

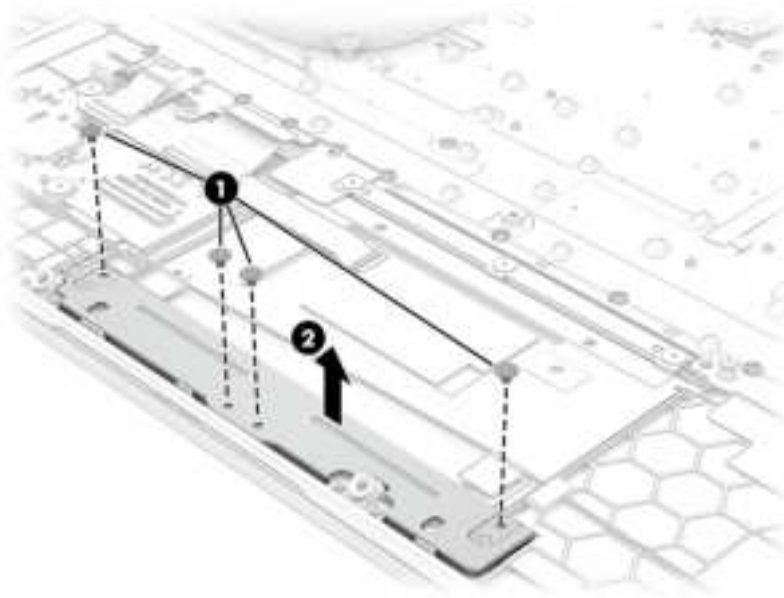

2. Lift the bottom of the system board to access the screws at the top of the touchpad.

You do not have to completely remove the system board. Remove all system board screws, disconnect the cables at the bottom and both sides of the system board, and then lift the system board up to access the touchpad screws. For more information, see [System board with heat sink on page 50](#).

 **NOTE:** All the cables except for the rear side connected to the system board (including the WLAN antennas and fan cables) should be disconnected before lifting the system board.

3. Remove the tape from the connector on the touchpad **(1)**, and then disconnect the touchpad cable **(2)** from the touchpad ZIF connector.
4. Lift the shielding off the top of the touchpad to allow access to the screws **(3)**.
5. Remove the three Phillips M2.0 × 2.0 screws **(4)** that secure the touchpad to the computer.

- Lift the top of the touchpad (5), and then pull it into the computer to remove it (6).

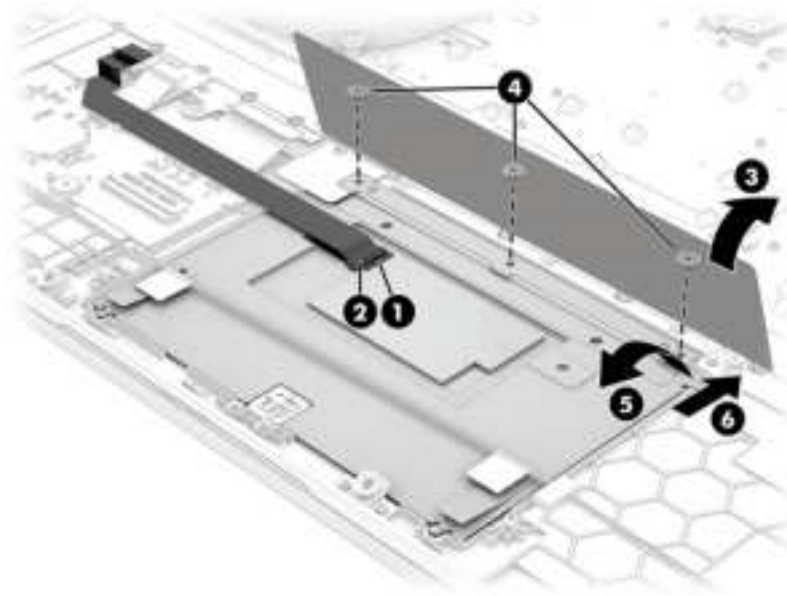

To install the touchpad, reverse this procedure.

Fans, full-feature models

To remove the fans, use this procedure and illustration.

Table 6-15 Fan descriptions and part numbers

Description	Spare part number
Fan kit, 80 W (models with RTX 4xxx graphics) (includes both fans)	N44737-001
Fan kit, 60 W (models with RTX 3xxx graphics) (includes both fans)	N44741-001

Before removing the fans, follow these steps:

- Prepare the computer for disassembly (see [Preparation for disassembly on page 39](#)).
- Remove the bottom cover (see [Bottom cover on page 39](#)).
- Disconnect the battery cable from the system board (see [Battery on page 41](#)).
- Remove the system board with heat sink (see [System board with heat sink on page 50](#)).

Remove the fans:

- Remove the three Phillips M2.0 × 3.5 screws (1) that secure each fan to the computer.

2. Remove the fans **(2)**.

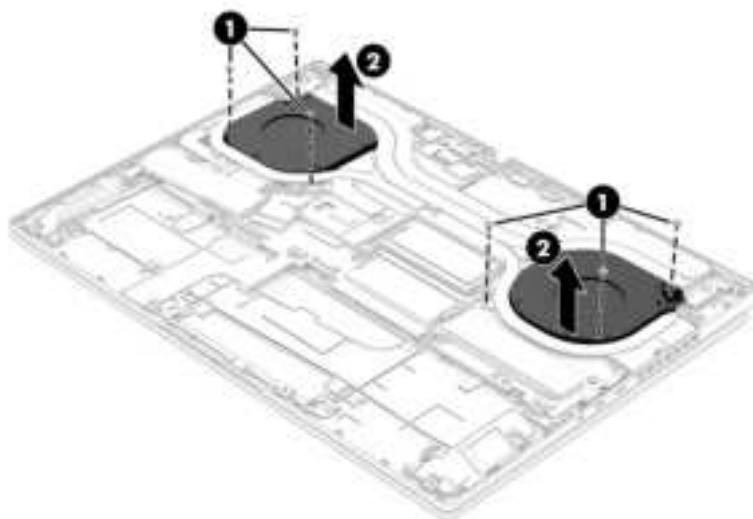

To install the fans, reverse this procedure.

Power connector, limited-feature models

To remove the power connector, use this procedure and illustration.

Table 6-16 Power connector description and part number

Description	Spare part number
Power connector	N44736-001

Before removing the power connector, follow these steps:

1. Prepare the computer for disassembly (see [Preparation for disassembly on page 39](#)).
2. Remove the bottom cover (see [Bottom cover on page 39](#)).
3. Disconnect the battery cable from the system board (see [Battery on page 41](#)).
4. Remove the system board with heat sink (see [System board with heat sink on page 50](#)).

Remove the power connector:

1. Remove the four Phillips M2.5 × 3.0 screws **(1)** from the hinge bracket.
2. Remove the bracket **(2)**.
The screws and bracket also secure the right display hinge.
3. Disconnect the cable from the system board **(3)**.

4. Remove the power connector and cable from the computer (4).

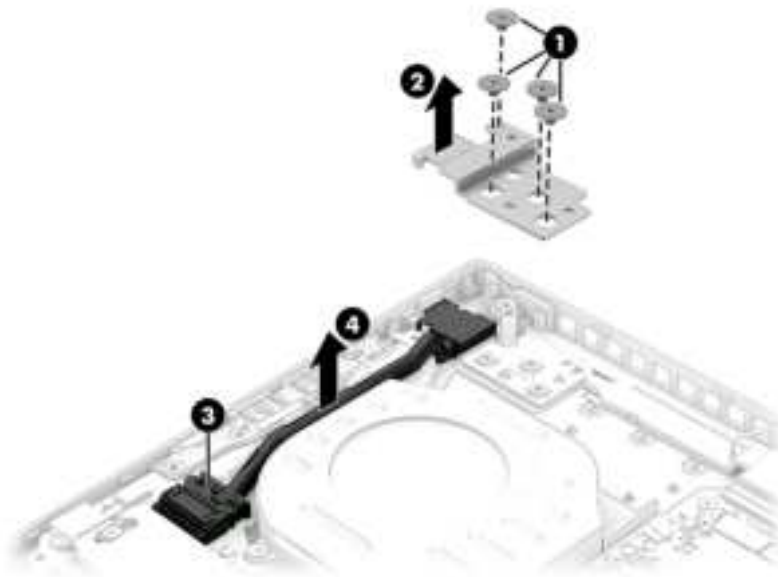

To install the power connector, reverse this procedure.

Display assembly

To remove and disassemble the display assembly, use these procedures and illustrations.

Full hinge-up displays are not available as spare parts. Spare parts for displays are available only at the subcomponent level.

Before removing the display panel, follow these steps:

1. Prepare the computer for disassembly (see [Preparation for disassembly on page 39](#)).
2. Remove the bottom cover (see [Bottom cover on page 39](#)).
3. Disconnect the battery cable from the system board (see [Battery on page 41](#)).

Remove the display assembly:

 **NOTE:** You can remove the bezel, display panel, and camera module without removing the entire display assembly from the computer.

1. You can remove the bezel with the display assembly connected to the computer. To remove the bezel:
 - a. Use your finger to release the bottom edge of the bezel (1) from the display assembly.
 - b. **From the outside of the bezel**, release the top, left, and right edges of the bezel (2) from the display assembly.
 - c. Remove the display bezel (3) from the display assembly.

 **IMPORTANT:** To avoid damaging the panel, **do not use a tool** to release the inside of the bezel. You can use a tool only when you insert it from the outside of the top, left, and right sides of the bezel. Use your fingers to lift up on the bezel. Avoid pressing down on the panel during removal.

The bezel is available as spare part number N44757-001 in aluminum models and N44758-001 in plastic models.

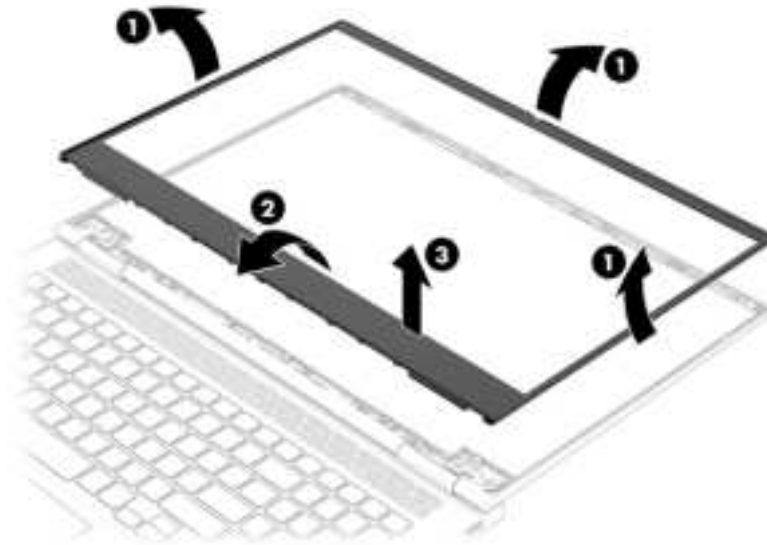

2. To remove the display panel:

- a. At the bottom left and right corners of the display panel, insert tweezers into the hole at the end of the stretchable tape (1) that is installed under the left and right sides of the display panel.
- b. While turning the tweezers (2), wrap the tape around the tweezers as you continue to pull the tape (3) out from behind the display panel.
- c. Lift the panel off the display enclosure (4).

 **NOTE:** In this procedure, the display assembly will not be connected to the computer.



- d. Peel the conductive tape (1) off the connector cable.
- e. Peel the tape (2) off the connector on the back of the display panel.
- f. Lift the locking latch (3) from the connector.
- g. Pull the cable (4) out of the connector.
- h. Remove the conductive tape strip (5) from the connector.

 **NOTE:** The number of pieces of tape that secure the cable to the connector can vary.

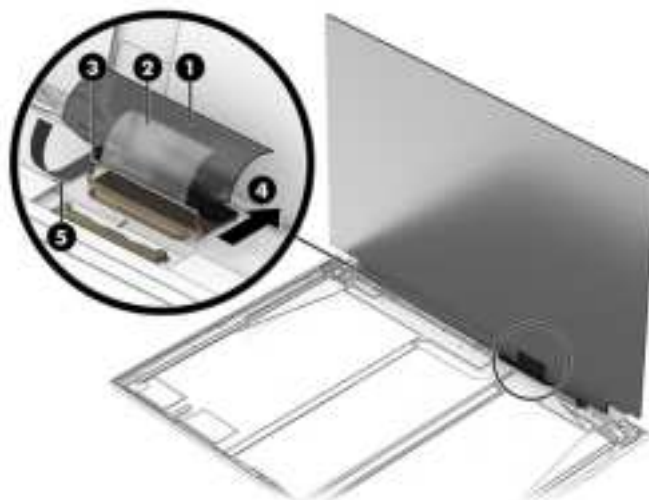

- i. When installing a display panel, be sure to install the tape on the left and right sides of the display back cover as shown in the following illustration. Display panel tape is available as spare part number N44766-001.

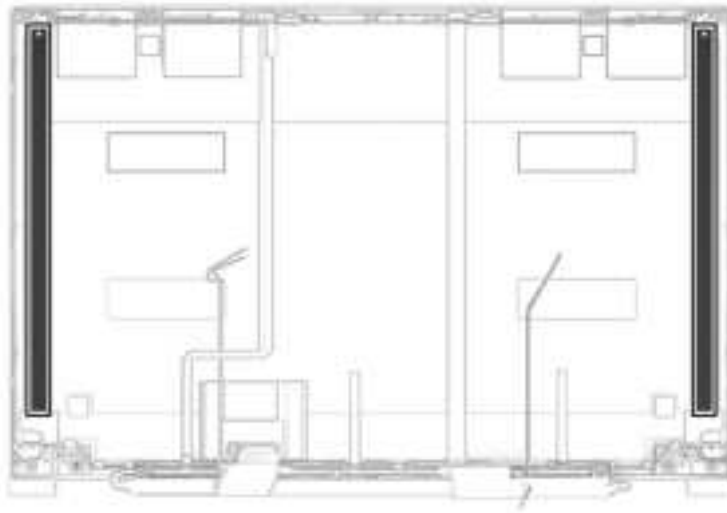

Display panels are available as the following spare part numbers:

- N44826-001—FHD, 250 nits
- N44827-001—FHD, 300 nits
- N44828-001—QHD, 300 nits

3. To replace the camera module:

- a. Use to tool to detach the module **(1)** from the display back cover. The module is attached with double-sided adhesive.
- b. Disconnect the cable from the ZIF connector on the camera module **(2)**, and then remove the module.

The camera module is available as spare part number N44735-001.



4. You must remove the display assembly from the computer to remove the remaining components. Remove the wireless antenna cable from the clips along its routing path on the computer.

Full-feature models

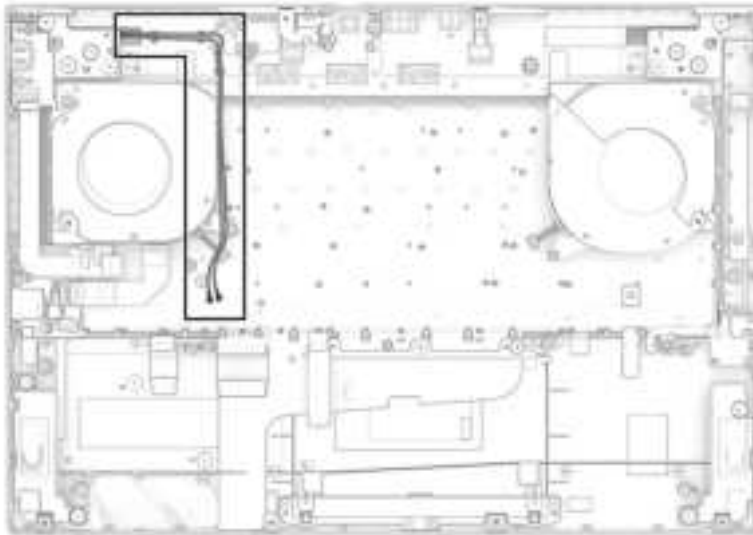

Limited-feature models

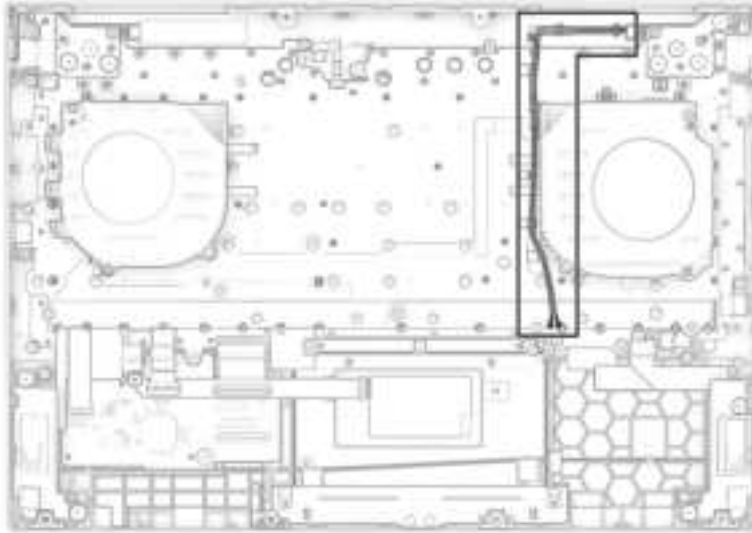

5. Remove the Phillips M2.0 × 3.0 screw from each hinge cover (1), and then push from the inside of the hinges away from the computer to release them (2). Note that a rubber insert is inside the hinge covers. Hinge covers are available as spare part number N44764-001.

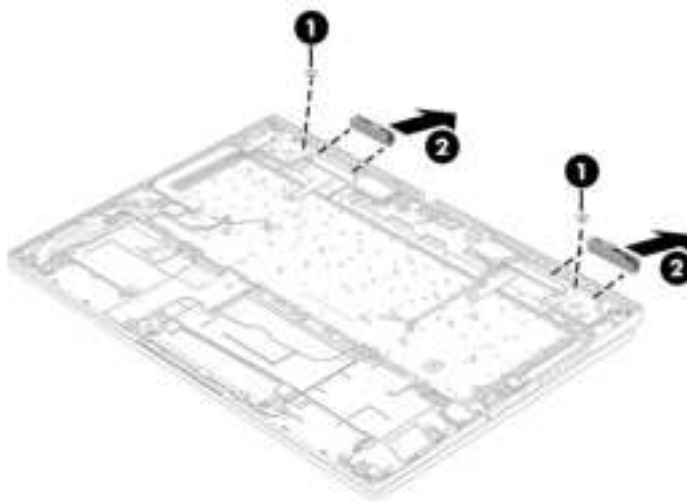

Before installing the hinge covers, be sure to place the two rubber pieces into the gaps on the reverse side of the top cover with keyboard as shown in the following illustration.

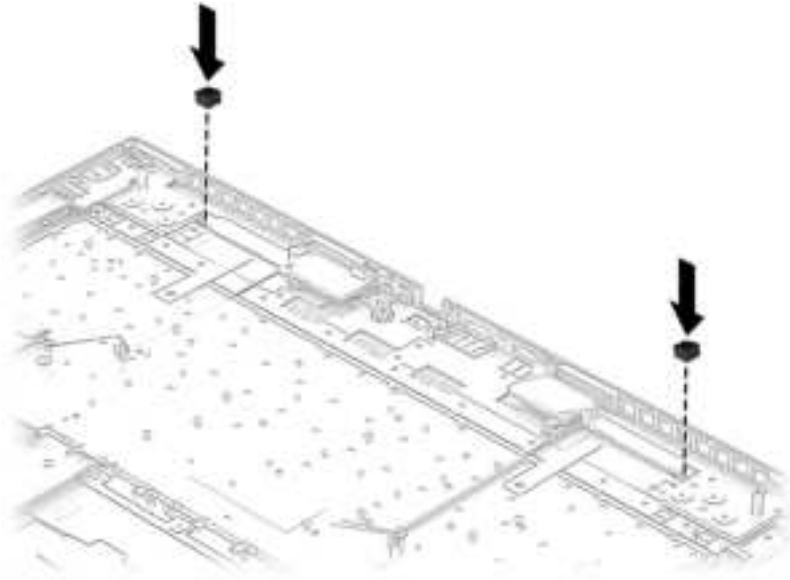

6. Remove any Mylar that covers the screws.
7. Remove the four Phillips M2.5 × 3.0 screws (1) from each hinge.
8. Remove the metal brackets from each hinge (2).
9. Open the display to 45° to open the hinges (3).
10. Separate the display from the computer while pulling the hinges (4) and cables (5) out of the slots in the computer.

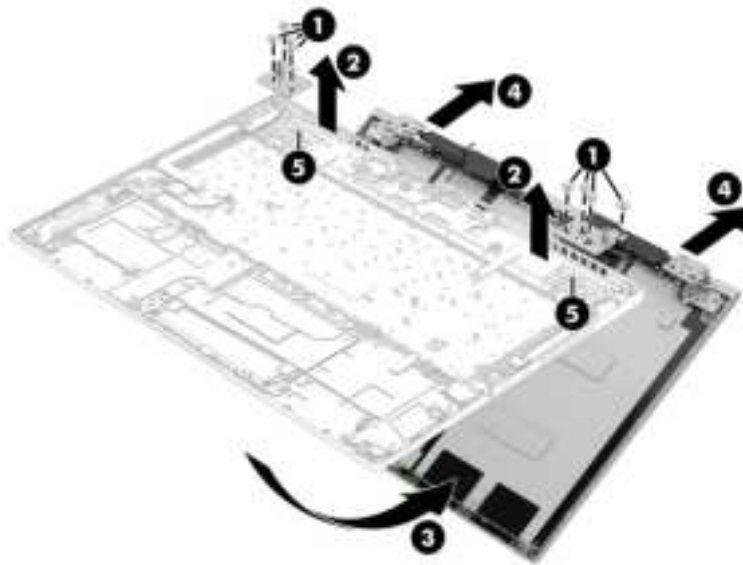

11. To remove the hinges from the display back cover:
 - a. Remove the three broadhead Phillips M2.0 × 2.5 screws (1) and Phillips M2.0 × 3.0 screw (2) that secure each hinge and bracket to the display back cover.

- b. Remove the hinges with brackets (3).

The display hinges are available using spare part number N44765-001.

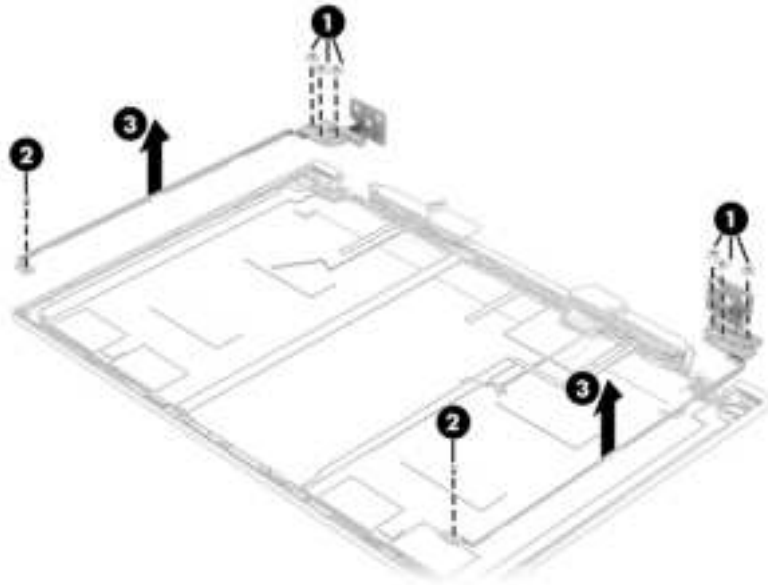

- 12. To remove the wireless antennas:

- a. Release the wireless antenna cables from the retention clips (1) along the top and side of the display back cover.
- b. Peel the wireless antennas off the display rear cover (2). The antennas are attached with double-sided adhesive. The wireless antennas are available using spare part number N44730-001 for plastic models and N44731-001 for aluminum models.

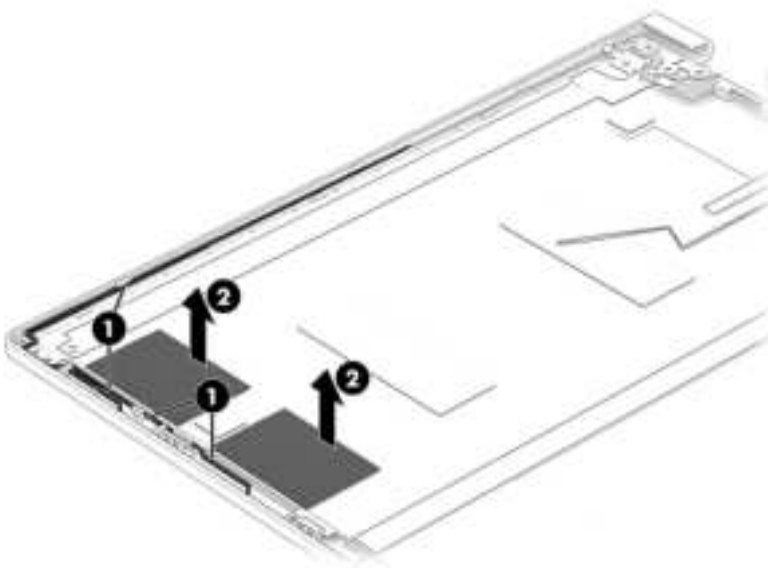

- 13. To remove the display cable:

- Peel the cable off the inside of the display rear cover and remove the cable from the retention clips at the bottom of the display rear cover.

The display cable is available as the following spare part numbers:

N44761-001: For use in aluminum models with a QHD display

N44762-001: For use in aluminum models with an FHD display

N44763-001: For use in plastic models with an FHD display

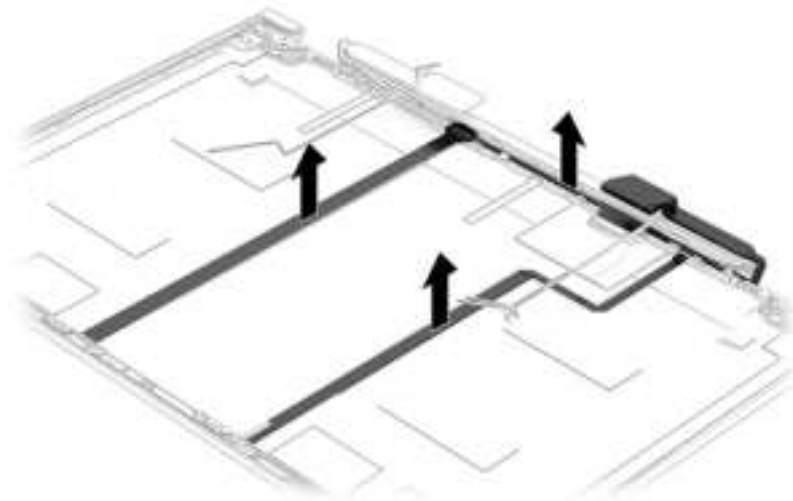

To reassemble and replace the display assembly, reverse this procedure.

Top cover with keyboard

The top cover with keyboard remains after removing all other spare parts from the computer. In this section, the first table provides the main spare part number for the top covers with keyboards. The second table provides the country codes.

Table 6-17 Top cover with keyboard descriptions and part numbers

Description	Spare part number
Aluminum, 4-zone lighting, numeric keypad	N56101-xx1
Aluminum, 4-zone lighting	N56102-xx1
Aluminum, 1-zone lighting, numeric keypad	N56103-xx1
Aluminum, 1-zone lighting	N56104-xx1
Plastic, 1-zone lighting, models with RTX 4xxx (80 W) graphics	N45350-xx1
Plastic, 4-zone lighting, models with RTX 4xxx (80 W) graphics	N45347-xx1

Table 6-18 Spare part country codes

For use in country or region	Spare part number	For use in country or region	Spare part number	For use in country or region	Spare part number
Belgium	-A41	Hungary	-211	Saudi Arabia	-171
Brazil	-201	Iceland	-DD1	Slovenia	-BA1
Bulgaria	-261	India	-D61	South Korea	-AD1
Chile	-161	Israel	-BB1	Spain	-071
Czech Republic/Slovakia	-FL1	Italy	-061	Switzerland	-BG1
Denmark	-081	Japan	-291	Taiwan	-AB1
Denmark, Finland, and Norway	-DH1	The Netherlands	-B31	Thailand	-281
French Canada	-DB1	Northern Africa	-FP1	Turkey	-141
Finland/Sweden	-B71	Norway	-091	Turkey-F	-541
France	-051	Portugal	-131	Ukraine	-BD1
Germany	-041	Romania	-271	United Kingdom	-031
Greece	-151	Russia	-251	United States	-001

7 Using Setup Utility (BIOS)

Setup Utility, or Basic Input/Output System (BIOS), controls communication between all the input and output devices on the system (such as disk drives, display, keyboard, mouse, and printer). Setup Utility (BIOS) includes settings for the types of devices installed, the startup sequence of the computer, and the amount of system and extended memory.

 **NOTE:** To start Setup Utility on convertible computers, your computer must be in notebook mode and you must use the keyboard attached to your notebook.

Starting Setup Utility (BIOS)

You have several ways to access the Setup Utility (BIOS).

 **IMPORTANT:** Use extreme care when making changes in Setup Utility (BIOS). Errors can prevent the computer from operating properly.

- Turn on or restart the computer and quickly press **f10**.

- or -

Turn on or restart the computer, quickly press **esc**, and then press **f10** when the Start menu is displayed.

Updating Setup Utility (BIOS)

Updated versions of Setup Utility (BIOS) might be available on the HP website. Most BIOS updates on the HP website are packaged in compressed files called *SoftPaqs*. Some download packages contain a file named *Readme.txt*, which contains information regarding installing and troubleshooting the file.

Determining the BIOS version

To decide whether you need to update Setup Utility (BIOS), first determine the BIOS version on your computer.

To reveal the BIOS version information (also known as *ROM date* and *System BIOS*), use one of these options.

- HP Support Assistant
 1. Select the **Search** icon in the taskbar, type `support` in the search box, and then select the **HP Support Assistant** app.

- or -

Select the question mark icon in the taskbar.

 2. Under **My notebook**, select **Specifications**.
- Setup Utility (BIOS)
 1. Start Setup Utility (BIOS) (see [Starting Setup Utility \(BIOS\) on page 73](#)).

2. Select **Main**, and then make note of the BIOS version.
 3. Select **Exit**, select one of the options, and then follow the on-screen instructions.
- In Windows, press **ctrl+alt+s**.

To check for later BIOS versions, see [Preparing for a BIOS update on page 74](#).

Preparing for a BIOS update

Be sure to follow all prerequisites before downloading and installing a BIOS update.

 **IMPORTANT:** To reduce the risk of damage to the computer or an unsuccessful installation, download and install a BIOS update only when the computer is connected to reliable external power using the AC adapter. Do not download or install a BIOS update while the computer is running on battery power, docked in an optional docking device, or connected to an optional power source. During the download and installation, follow these instructions:

- Do not disconnect power from the computer by unplugging the power cord from the AC outlet.
- Do not shut down the computer or initiate Sleep.
- Do not insert, remove, connect, or disconnect any device, cable, or cord.

 **NOTE:** If your computer is connected to a network, consult the network administrator before installing any software updates, especially system BIOS updates.

Downloading a BIOS update

After you review the prerequisites, you can check for and download BIOS updates.

1. Select the **Search** icon in the taskbar, type `support` in the search box, and then select the **HP Support Assistant** app.

- or -
Select the question mark icon in the taskbar.
2. Select **Updates**. The **Checking for Updates** window opens, and Windows checks for updates.
3. Follow the on-screen instructions.
4. At the download area, follow these steps:
 - a. Identify the most recent BIOS update and compare it to the BIOS version currently installed on your computer. If the update is more recent than your BIOS version, make a note of the date, name, or other identifier. You might need this information to locate the update later, after it has been downloaded to your hard drive.
 - b. Follow the on-screen instructions to download your selection to the hard drive.

Make a note of the path to the location on your hard drive where the BIOS update is downloaded. You will need to access this path when you are ready to install the update.

Installing a BIOS update

BIOS installation procedures vary. Follow any instructions that appear on the screen after the download is complete. If no instructions appear, follow these steps.

1. Select the **Search** icon in the taskbar, type `file` in the search box, and then select **File Explorer**.

2. Select your hard drive designation. The hard drive designation is typically Local Disk (C:).
3. Using the hard drive path you recorded earlier, open the folder that contains the update.
4. Double-click the file that has an .exe extension (for example, *filename.exe*).

The BIOS installation begins.

5. Complete the installation by following the on-screen instructions.



NOTE: After a message on the screen reports a successful installation, you can delete the downloaded file from your hard drive.

8 Using HP PC Hardware Diagnostics

You can use the HP PC Hardware Diagnostics utility to determine whether your computer hardware is running properly. The three versions are HP PC Hardware Diagnostics Windows, HP PC Hardware Diagnostics UEFI (Unified Extensible Firmware Interface), and (for select products only) Remote HP PC Hardware Diagnostics UEFI, a firmware feature.

Using HP PC Hardware Diagnostics Windows (select products only)

HP PC Hardware Diagnostics Windows is a Windows-based utility that allows you to run diagnostic tests to determine whether the computer hardware is functioning properly. The tool runs within the Windows operating system to diagnose hardware failures.

If HP PC Hardware Diagnostics Windows is not installed on your computer, you must download and install it. To download HP PC Hardware Diagnostics Windows, see [Downloading HP PC Hardware Diagnostics Windows on page 77](#).

Using an HP PC Hardware Diagnostics Windows hardware failure ID code

When HP PC Hardware Diagnostics Windows detects a failure that requires hardware replacement, a 24-digit failure ID code is generated for select component tests. For interactive tests, such as keyboard, mouse, or audio and video palette, you must perform troubleshooting steps before you can receive a failure ID.

- You have several options after you receive a failure ID:
 - Select **Next** to open the Event Automation Service (EAS) page, where you can log the case.
 - Scan the QR code with your mobile device, which takes you to the EAS page, where you can log the case.
 - Select the box next to the 24-digit failure ID to copy your failure code and send it to support.

Accessing HP PC Hardware Diagnostics Windows

After HP PC Hardware Diagnostics Windows is installed, you can access it from HP Support Assistant or the Start menu.

Accessing HP PC Hardware Diagnostics Windows from HP Support Assistant

After HP PC Hardware Diagnostics Windows is installed, follow these steps to access it from HP Support Assistant:

1. Complete one of the following tasks:
 - Select the **Search** icon in the taskbar, type `support` in the search box, and then select the **HP Support Assistant** app.
 - Select the question mark icon in the taskbar.
2. Select **Fixes & Diagnostics**.

3. Select **Run hardware diagnostics**, and then select **Launch**.
4. When the tool opens, select the type of diagnostic test that you want to run, and then follow the on-screen instructions.

 **NOTE:** To stop a diagnostic test, select **Cancel**.

Accessing HP PC Hardware Diagnostics Windows from the Start menu (select products only)

After HP PC Hardware Diagnostics Windows is installed, follow these steps to access it from the Start menu:

1. Select the **Start** button, and then select **All apps**.
2. Select **HP PC Hardware Diagnostics Windows**.
3. When the tool opens, select the type of diagnostic test that you want to run, and then follow the on-screen instructions.

 **NOTE:** To stop a diagnostic test, select **Cancel**.

Downloading HP PC Hardware Diagnostics Windows

The HP PC Hardware Diagnostics Windows downloading instructions are provided in English only. You must use a Windows computer to download this tool because only .exe files are provided.

Downloading the latest HP PC Hardware Diagnostics Windows version from HP

To download HP PC Hardware Diagnostics Windows from HP, follow these steps:

1. Go to <http://www.hp.com/go/techcenter/pcdiags>. The HP PC Diagnostics home page is displayed.
2. Select **Download HP Diagnostics Windows**, and then select the specific Windows diagnostics version to download to your computer or a USB flash drive.

The tool downloads to the selected location.

Downloading the HP PC Hardware Diagnostics Windows from the Microsoft Store

You can download the HP PC Hardware Diagnostics Windows from the Microsoft Store:

1. Select the Microsoft Store app on your desktop or select the **Search** icon in the taskbar, and then type `Microsoft Store` in the search box.
2. Type `HP PC Hardware Diagnostics Windows` in the **Microsoft Store** search box.
3. Follow the on-screen directions.

The tool downloads to the selected location.

Downloading HP Hardware Diagnostics Windows by product name or number (select products only)

You can download HP PC Hardware Diagnostics Windows by product name or number.

 **NOTE:** For some products, you might have to download the software to a USB flash drive by using the product name or number.

1. Go to <http://www.hp.com/support>.
2. Select **Software and Drivers**, select your type of product, and then enter the product name or number in the search box that is displayed.
3. In the **Diagnostics** section, select **Download**, and then follow the on-screen instructions to select the specific Windows diagnostics version to be downloaded to your computer or USB flash drive.

The tool downloads to the selected location.

Installing HP PC Hardware Diagnostics Windows

To install HP PC Hardware Diagnostics Windows, navigate to the folder on your computer or the USB flash drive where the .exe file downloaded, double-click the .exe file, and then follow the on-screen instructions.

Using HP PC Hardware Diagnostics UEFI

HP PC Hardware Diagnostics Unified Extensible Firmware Interface (UEFI) allows you to run diagnostic tests to determine whether the computer hardware is functioning properly. The tool runs outside the operating system so that it can isolate hardware failures from issues that are caused by the operating system or other software components.

 **NOTE:** For some products, you must use a Windows computer and a USB flash drive to download and create the HP UEFI support environment because only .exe files are provided. For more information, see [Downloading HP PC Hardware Diagnostics UEFI to a USB flash drive on page 79](#).

If your PC does not start in Windows, you can use HP PC Hardware Diagnostics UEFI to diagnose hardware issues.

Using an HP PC Hardware Diagnostics UEFI hardware failure ID code

When HP PC Hardware Diagnostics UEFI detects a failure that requires hardware replacement, a 24-digit failure ID code is generated.

For assistance in solving the problem, complete one of these tasks:

- Select **Contact HP**, accept the HP privacy disclaimer, and then use a mobile device to scan the failure ID code that appears on the next screen. The HP Customer Support - Service Center page appears with your failure ID and product number automatically filled in. Follow the on-screen instructions.
- Contact support, and provide the failure ID code.

Starting HP PC Hardware Diagnostics UEFI

To start HP PC Hardware Diagnostics UEFI, follow this procedure.

1. Turn on or restart the computer, and quickly press **esc**.
2. Press **f2**.

The BIOS searches three places for the diagnostic tools, in the following order:

- a. Connected USB flash drive

 **NOTE:** To download the HP PC Hardware Diagnostics UEFI tool to a USB flash drive, see [Downloading the latest HP PC Hardware Diagnostics UEFI version on page 80.](#)

- b. Hard drive
 - c. BIOS
3. When the diagnostic tool opens, select the type of diagnostic test that you want to run, and then follow the on-screen instructions.

Starting HP PC Hardware Diagnostics UEFI through HP Hotkey Support software (select products only)

This section describes how to start HP PC Hardware Diagnostics UEFI through HP Hotkey Support software.

 **NOTE:** You must disable fast boot to access HP PC Hardware Diagnostics UEFI from the HP System Information application. To disable fast boot:

1. Turn on or restart the computer, and when the HP logo appears, press **f10** to enter Computer Setup.
 2. Select **Advanced**, and then select **Boot Options**.
 3. Clear **Fast Boot**.
 4. Select **Save Changes and Exit**, and then select **Yes**.
-

To start HP PC Hardware Diagnostics UEFI through HP Hotkey Support software, follow this procedure.

1. From the **Start** menu, open the HP System Information Application or enter **fn+esc**.
2. In HP System Information screen, select **Run System Diagnostics**, select **Yes** to run the application, and then select **Restart**.

 **IMPORTANT:** To prevent loss of data, save your work in all open apps before restarting your computer.

 **NOTE:** When the restart is complete, the computer will boot to HP PC Hardware Diagnostics UEFI Application. Proceed with the troubleshooting tests.

Downloading HP PC Hardware Diagnostics UEFI to a USB flash drive

Downloading HP PC Hardware Diagnostics UEFI to a USB flash drive can be useful in some situations.

- HP PC Hardware Diagnostics UEFI is not included in the preinstallation image.
- HP PC Hardware Diagnostics UEFI is not included in the HP Tool partition.
- The hard drive is damaged.

 **NOTE:** The HP PC Hardware Diagnostics UEFI downloading instructions are provided in English only, and you must use a Windows computer to download and create the HP UEFI support environment because only .exe files are provided.

Downloading the latest HP PC Hardware Diagnostics UEFI version

To download the latest HP PC Hardware Diagnostics UEFI version to a USB flash drive, follow this procedure:

1. Go to <http://www.hp.com/go/techcenter/pcdiags>. The HP PC Diagnostics home page is displayed.
2. Select **Download HP Diagnostics UEFI**, and then select **Run**.

Downloading HP PC Hardware Diagnostics UEFI by product name or number (select products only)

You can download HP PC Hardware Diagnostics UEFI by product name or number (select products only) to a USB flash drive.

 **NOTE:** For some products, you might have to download the software to a USB flash drive by using the product name or number.

1. Go to <http://www.hp.com/support>.
2. Enter the product name or number, select your computer, and then select your operating system.
3. In the **Diagnostics** section, follow the on-screen instructions to select and download the specific UEFI Diagnostics version for your computer.

Using Remote HP PC Hardware Diagnostics UEFI settings (select products only)

Remote HP PC Hardware Diagnostics UEFI is a firmware (BIOS) feature that downloads HP PC Hardware Diagnostics UEFI to your computer. It can then run the diagnostics on your computer, and it might upload results to a preconfigured server.

For more information about Remote HP PC Hardware Diagnostics UEFI, go to <http://www.hp.com/go/techcenter/pcdiags>, and then select **Find out more**.

Downloading Remote HP PC Hardware Diagnostics UEFI

Remote HP PC Hardware Diagnostics UEFI is also available as a SoftPaq that you can download to a server.

Downloading the latest Remote HP PC Hardware Diagnostics UEFI version

You can download the latest Remote HP PC Hardware Diagnostics UEFI version to a USB flash drive.

1. Go to <http://www.hp.com/go/techcenter/pcdiags>. The HP PC Diagnostics home page is displayed.
2. Select **Download Remote Diagnostics**, and then select **Run**.

Downloading Remote HP PC Hardware Diagnostics UEFI by product name or number

You can download Remote HP PC Hardware Diagnostics UEFI by product name or number.

 **NOTE:** For some products, you might have to download the software by using the product name or number.

1. Go to <http://www.hp.com/support>.

2. Select **Software and Drivers**, select your type of product, enter the product name or number in the search box that is displayed, select your computer, and then select your operating system.
3. In the **Diagnostics** section, follow the on-screen instructions to select and download the **Remote UEFI** version for the product.

Customizing Remote HP PC Hardware Diagnostics UEFI settings

Using the Remote HP PC Hardware Diagnostics setting in Computer Setup (BIOS), you can perform several customizations.

- Set a schedule for running diagnostics unattended. You can also start diagnostics immediately in interactive mode by selecting **Execute Remote HP PC Hardware Diagnostics UEFI**.
- Set the location for downloading the diagnostic tools. This feature provides access to the tools from the HP website or from a server that has been preconfigured for use. Your computer does not require the traditional local storage (such as a hard drive or USB flash drive) to run remote diagnostics.
- Set a location for storing the test results. You can also set the user name and password that you use for uploads.
- Display status information about the diagnostics run previously.



To customize Remote HP PC Hardware Diagnostics UEFI settings, follow these steps:

1. Turn on or restart the computer, and when the HP logo appears, press **f10** to enter Computer Setup.
2. Select **Advanced**, and then select **Settings**.
3. Make your customization selections.
4. Select **Exit**, then select **Save Changes and Exit** to save your settings.

Your changes take effect when the computer restarts.

9 Backing up, restoring, and recovering

You can use Windows tools or HP software to back up your information, create a restore point, reset your computer, create recovery media, or restore your computer to its factory state. Performing these standard procedures can return your computer to a working state faster.

-
-  **IMPORTANT:** If you are performing recovery procedures on a tablet, the tablet battery must be at least 70% charged before you start the recovery process.
 -  **IMPORTANT:** For a tablet with a detachable keyboard, connect the tablet to the keyboard base before beginning any recovery process.
-

Backing up information and creating recovery media

These methods of creating recovery media and backups are available on select products only.

Using Windows tools for backing up

HP recommends that you back up your information immediately after initial setup. You can do this task either using Windows Backup locally with an external USB flash drive or using online tools.

-
-  **NOTE:** If computer storage is 32 GB or less, Microsoft® System Restore is disabled by default.
-

Using the HP Cloud Recovery Download Tool to create recovery media (select products only)

You can use the HP Cloud Recovery Download Tool to create HP Recovery media on a bootable USB flash drive.

For details:

- Go to <http://www.hp.com>, search for HP Cloud Recovery, and then select the result that matches the type of computer that you have.

-
-  **NOTE:** If you cannot create recovery media yourself, contact support to obtain recovery discs. Go to <http://www.hp.com/support>, select your country or region, and then follow the on-screen instructions.

-  **IMPORTANT:** HP recommends that you follow the [Restoring and recovery methods on page 83](#) to restore your computer before you obtain and use the HP recovery discs. Using a recent backup can return your machine to a working state sooner than using the HP recovery discs. After the system is restored, reinstalling all the operating system software released since your initial purchase can be a lengthy process.
-

Restoring and recovering your system

You have several tools available to recover your system both within and outside of Windows if the desktop cannot load.

HP recommends that you attempt to restore your system using the [Restoring and recovery methods on page 83](#).

Creating a system restore

System Restore is available in Windows. The System Restore software can automatically or manually create restore points, or snapshots, of the system files and settings on the computer at a particular point.

When you use System Restore, it returns your computer to its state at the time you made the restore point. Your personal files and documents should not be affected.

Restoring and recovery methods

After you run the first method, test to see whether the issue still exists before you proceed to the next method, which might now be unnecessary.

1. Run a Microsoft System Restore.
2. Run Reset this PC.

 **NOTE:** The options **Remove everything** and then **Fully clean the drive** can take several hours to complete and leave no information on your computer. It is the safest way to reset your computer before you recycle it.

3. Recover using HP Recovery media. For more information, see [Recovering using HP Recovery media on page 83](#).

For more information about the first two methods, see the Get Help app:

- Select the **Start** button, select **All apps**, select the **Get Help** app, and then enter the task you want to perform.

 **NOTE:** You must be connected to the internet to access the Get Help app.

Recovering using HP Recovery media

You can use HP Recovery media to recover the operating system and drivers that were installed at the factory. On select products, you can create recovery media on a bootable USB flash drive using the HP Cloud Recovery Download Tool.

For details, see [Using the HP Cloud Recovery Download Tool to create recovery media \(select products only\) on page 82](#).

 **NOTE:** If you cannot create recovery media yourself, contact support to obtain recovery discs. Go to <http://www.hp.com/support>, select your country or region, and then follow the on-screen instructions.

To recover your system:

- Insert the HP Recovery media, and then restart the computer.

 **NOTE:** HP recommends that you follow the [Restoring and recovery methods on page 83](#) to restore your computer before you obtain and use the HP recovery discs. Using a recent backup can return your machine to a working state sooner than using the HP recovery discs. After the system is restored, reinstalling all the operating system software released since your initial purchase can be a lengthy process.

Changing the computer boot order

If your computer does not restart using the HP Recovery media, you can change the computer boot order, which is the order of devices listed in BIOS for startup information. You can select an optical drive or a USB flash drive, depending on the location of your HP Recovery media.

 **IMPORTANT:** For a tablet with a detachable keyboard, connect the tablet to the keyboard base before beginning these steps.

To change the boot order:

1. Insert the HP Recovery media.
2. Access the system **Startup** menu.
 - For computers or tablets with keyboards attached, turn on or restart the computer or tablet, quickly press **esc**, and then press **f9** for boot options.
 - For tablets without keyboards, turn on or restart the tablet, quickly press and hold the volume up button, and then select **f9**.

– or –

Turn on or restart the tablet, quickly press and hold the volume down button, and then select **f9**.
3. Select the optical drive or USB flash drive from which you want to boot, and then follow the on-screen instructions.

Using HP Sure Recover (select products only)

Select computer models are configured with HP Sure Recover, a PC operating system (OS) recovery solution built into the hardware and software. HP Sure Recover can fully restore the HP OS image without installed recovery software.

Using HP Sure Recover, an administrator or user can restore the system and install:

- Latest version of the operating system
- Platform-specific device drivers
- Software applications, in the case of a custom image

To access the latest documentation for HP Sure Recover, go to <http://www.hp.com/support>. Follow the on-screen instructions to find your product and locate your documentation.

10 Specifications

This chapter provides specifications for your computer system.

Computer specifications

This section provides specifications for your computer. When you travel with your computer, the computer dimensions and weights, input power ratings, and operating specifications provide helpful information.

Table 10-1 Computer specifications

	Metric	U.S.
Dimensions		
Width	369.0 mm	14.50 in
Depth	259.4 mm	10.20 in
Height (limited-feature models)	23.9 mm	0.94 in
Height (full-feature models)	23.5 mm	0.93 in
Weight (limited-feature models, 4xxx graphics)	2362.2 g	5.21 lb
Weight (full-feature models, 3xxx graphics)	2381.0 g	5.24 lb
Weight (full-feature models, 4xxx graphics)	2448.2 g	5.40 lb
Input power		
Operating voltage and current	19.5 V DC @ 10.3 A - 200 W	
	19.5 V DC @ 11.8 A - 230 W	
	20 V DC @ 14 A - 280 W	
Temperature		
Operating	5°C to 35°C	41°F to 95°F
Nonoperating	-20°C to 60°C	-4°F to 140°F
Relative humidity (noncondensing)		
Operating	10% to 90%	
Nonoperating	5% to 95%	
Maximum altitude (unpressurized)		
Operating	-15 m to 3,048 m	-50 ft to 10,000 ft
Nonoperating	-15 m to 12,192 m	-50 ft to 40,000 ft

NOTE: Applicable product safety standards specify thermal limits for plastic surfaces. The device operates well within this range of temperatures.

Display specifications

This section provides specifications for your display.

Table 10-2 Display specifications

	Metric	U.S.
Active diagonal size	40.9 cm	16.1 in
Resolution	1920 × 1080 (FHD) 2560 × 1440 (QHD)	
Surface treatment	Antiglare	
Brightness	250 nits (45% NTSC) 300 nits (100% sRGB)	
Refresh rate	240 Hz (QHD) 165 Hz (FHD, 100% sRGB) 144 Hz (FHD, 45% NTSC)	
Viewing angle	UWVA	
Backlight	WLED	
Display panel interface	eDP	

Solid-state drive specifications

This section provides specifications for your solid-state drives.

Table 10-3 Solid-state drive specifications

	256 GB*	512 GB*	1TB*
Dimensions			
Height	1.0 mm	1.0 mm	1.0 mm
Length	50.8 mm	50.8 mm	50.8 mm
Width	28.9 mm	28.9 mm	28.9 mm
Weight	< 10 g	< 10 g	< 10 g
Interface type			
Ready time, maximum (to not busy)	1.0 ms	< 1.0 ms	1.0 ms
Access times, logical	0.1 ms	0.1 ms	0.1 ms
Transfer rate			
Sequential read	up to 2150 MBps	up to 2150 MBps	up to 2150 MBps
Random read	Up to 300,000 IOPs	Up to 300,000 IOPs	Up to 300,000 IOPs
Sequential write	up to 1550 MBps	up to 1550 MBps	up to 1550 MBps
Random write	Up to 100,000 IOPs	Up to 100,000 IOPs	Up to 100,000 IOPs

Table 10-3 Solid-state drive specifications (continued)

	256 GB*	512 GB*	1 TB*
Total logical sectors	468,883,296	1,000,215,216	1,500,336,388
Operating temperature	0°C to 70°C (32°F to 158°F)		

*1 GB = 1 billion bytes when referring to hard drive storage capacity. Actual accessible capacity is less. Actual drive specifications might differ slightly.

NOTE: Certain restrictions and exclusions apply. Contact support for details.

11 Power cord set requirements

This chapter provides power cord requirements for countries and regions.

The wide-range input feature of the computer permits it to operate from any line voltage from 100 V AC to 120 V AC, or from 220 V AC to 240 V AC.

The three-conductor power cord set included with the computer meets the requirements for use in the country or region where the equipment is purchased.

Power cord sets for use in other countries or regions must meet the requirements of the country and region where the computer is used.

Requirements for all countries

These power cord requirements are applicable to all countries and regions.

- The length of the power cord set must be at least **1.0 m** (3.3 ft) and no more than **2.0 m** (6.5 ft).
- All power cord sets must be approved by an acceptable accredited agency responsible for evaluation in the country or region where the power cord set will be used.
- The power cord sets must have a minimum current capacity of 10 A and a nominal voltage rating of 125 V AC or 250 V AC, as required by the power system of each country or region.
- The appliance coupler must meet the mechanical configuration of an EN 60 320/IEC 320 Standard Sheet C13 connector for mating with the appliance inlet on the back of the computer.

Requirements for specific countries and regions

To determine power cord requirements for specific countries and regions, use this table.

Table 11-1 Power cord requirements for specific countries and regions

Country/region	Accredited agency	Applicable note number
Argentina	IRAM	1
Australia	SAA	1
Austria	OVE	1
Belgium	CEBEC	1
Brazil	ABNT	1
Canada	CSA	2
Chile	IMQ	1
Denmark	DEMKO	1
Finland	FIMKO	1
France	UTE	1

Table 11-1 Power cord requirements for specific countries and regions (continued)

Country/region	Accredited agency	Applicable note number
Germany	VDE	1
India	BIS	1
Israel	SII	1
Italy	IMQ	1
Japan	JIS	3
Netherlands	KEMA	1
New Zealand	SANZ	1
Norway	NEMKO	1
People's Republic of China	CCC	4
Saudi Arabia	SASO	7
Singapore	PSB	1
South Africa	SABS	1
South Korea	KTL	5
Sweden	SEMKO	1
Switzerland	SEV	1
Taiwan	BSMI	6
Thailand	TISI	1
United Kingdom	ASTA	1
United States	UL	2

1. The flexible cord must be Type H05VV-F, three-conductor, 0.75 mm² conductor size. Power cord set fittings (appliance coupler and wall plug) must bear the certification mark of the agency responsible for evaluation in the country or region where it will be used.
2. The flexible cord must be Type SVT/SJT or equivalent, No. 18 AWG, three-conductor. The wall plug must be a two-pole grounding type with a NEMA 5-15P (15 A, 125 V AC) or NEMA 6-15P (15 A, 250 V AC) configuration. CSA or C-UL mark. UL file number must be on each element.
3. The appliance coupler, flexible cord, and wall plug must bear a T mark and registration number in accordance with the Japanese Dentori Law. The flexible cord must be Type VCTF, three-conductor, 0.75 mm² or 1.25 mm² conductor size. The wall plug must be a two-pole grounding type with a Japanese Industrial Standard C8303 (7 A, 125 V AC) configuration.
4. The flexible cord must be Type RVV, three-conductor, 0.75 mm² conductor size. Power cord set fittings (appliance coupler and wall plug) must bear the CCC certification mark.
5. The flexible cord must be Type H05VV-F three-conductor, 0.75 mm² conductor size. KTL logo and individual approval number must be on each element. Approval number and logo must be printed on a flag label.
6. The flexible cord must be Type HVCTF three-conductor, 1.25 mm² conductor size. Power cord set fittings (appliance coupler, cable, and wall plug) must bear the BSMI certification mark.
7. For 127 V AC, the flexible cord must be Type SVT or SJT 3-conductor, 18 AWG, with plug NEMA 5-15P (15 A, 125 V AC), with UL and CSA or C-UL marks. For 240 V AC, the flexible cord must be Type H05VV-F three-conductor, 0.75 mm² or 1.00 mm² conductor size, with plug BS 1363/A with BSI or ASTA marks.

12 Recycling

When a nonrechargeable or rechargeable battery has reached the end of its useful life, do not dispose of the battery in general household waste. Follow the local laws and regulations in your area for battery disposal.

HP encourages customers to recycle used electronic hardware, HP original print cartridges, and rechargeable batteries. For more information about recycling programs, see the HP website at <http://www.hp.com/recycle>.

Index

A

- AC adapter and battery light, identifying 6, 15
- AC adapter, spare part number 24
- action key, identifying 12
- antenna
 - illustrated 24
 - spare part number 24
- audio board
 - removal 57, 58
 - spare part number 57, 58
- audio-out (headphone)/audio-in (microphone) combo jack, identifying 7
- audio, product description 2

B

- backup, creating 82
- backups 82
- battery
 - illustrated 21
 - spare part number 21
- bezel
 - illustrated 23
 - spare part numbers 23
- BIOS
 - determining version 73
 - downloading an update 74
 - starting the Setup Utility 73
 - updating 73
- Bluetooth label 16
- boot order, changing 84
- bottom components 15
- bottom cover
 - illustrated 21
 - removal 39
 - spare part number 39
 - spare part numbers 21
- buttons
 - left touchpad 9, 10
 - power 12
 - right touchpad 9, 10

C

- calculator key, identifying 13

- camera
 - identifying 8
- camera light, identifying 8
- camera module
 - illustrated 23
 - spare part number 23
- camera privacy cover, identifying 8
- caps lock light 11
- caring for your computer 30
- cautions
 - electrostatic discharge 26, 27
- cleaning your computer 30
 - caring for wood veneer 32
 - disinfecting 31
 - HP Easy Clean 30
 - removing dirt and debris 30
- components
 - bottom 15
 - display 7, 8
 - keyboard area 9
 - left side 6
 - lights 10
 - rear 14
 - right side 5
 - touchpad 9
- computer major components 19
- computer specifications 85
- connectors
 - power 6, 14
- control zone 9

D

- display
 - specifications 85, 86
- display assembly
 - subcomponents 22
- display back cover
 - illustrated 24
 - spare part numbers 24
- display components 7, 8
- display panel
 - illustrated 23
 - product description 2
 - spare part numbers 23
- display panel cable
 - illustrated 24
 - spare part number 24

E

- electrostatic discharge (ESD) 26, 27
 - preventing damage 26-28
- esc key, identifying 12

F

- fan kit
 - illustrated 22, 46, 61
 - removal 46, 61
 - spare part number 46, 61
 - spare part numbers 22, 46, 61
- fn key, identifying 12

G

- graphics controller, product description 1
- grounding methods 26-28
- guidelines
 - packaging 26, 32
 - transporting 26, 32
 - workstation 26

H

- hard drive
 - product description 2
 - specifications 85
- HDMI port
 - identifying 5, 15
- heat sink
 - illustrated 20
 - spare part numbers 20
- heat sink assembly
 - removal 48
 - spare part number 48
- hinge
 - illustrated 23
 - spare part numbers 23
- hinge cover
 - illustrated 24
 - spare part number 24
- HP OMEN Gaming Hub, using 13
- HP PC Hardware Diagnostics UEFI
 - downloading 79
 - failure ID code 78
 - HP Hotkey Support software 79

- starting 78,79
 - using 78
- HP PC Hardware Diagnostics Windows
 - accessing 76,77
 - downloading 77
 - failure ID code 76
 - installing 78
 - using 76
- HP Recovery media
 - recovery 83
- HP Sure Recover 84

I

- illustrated parts catalog 19
- integrated numeric keypad, identifying 13
- internal microphones, identifying 8
- IR board
 - removal 56
 - spare part numbers 56
- IR sensor board
 - illustrated 22
 - spare part number 22

J

- jacks
 - audio-out (headphone)/audio-in (microphone) 7
 - network 6,15
 - RJ-45 (network) 6,15

K

- keyboard
 - product description 3
- keys
 - action 12
 - calculator 13
 - esc 12
 - fn 12
 - num lock 13
 - OMEN 12
 - Windows 12
 - Windows application 12

L

- labels
 - Bluetooth 16
 - regulatory 16
 - serial number 16
 - service 16
 - wireless certification 16

- WLAN 16
- left control zone, identifying 9
- left side components 6
- lights
 - AC adapter and battery 6,15
 - camera 8
 - caps lock 11
 - mute 11
 - power 11
 - RJ-45 (network) status 6,15
 - touchpad 9,11
- low blue light mode 7

M

- memory module
 - product description 2
- memory modules
 - removal 37
 - spare part numbers 37
- microphone
 - product description 2
- model name 1
- mute light, identifying 11

N

- network jack, identifying 6,15
- num lock key, identifying 13

O

- OMEN key, identifying 12
- operating system, product description 4

P

- packaging guidelines 26,32
- pointing device, product description 3
- ports
 - HDMI 5,15
 - product description 3
 - USB 5
 - USB port with HP Sleep and Charge 6,7
 - USB SuperSpeed 15
 - USB Type-C port with HP Sleep and Charge 5,7
- power button, identifying 12
- power connector
 - identifying 6,14
 - removal 62
 - spare part number 62

- power cord
 - requirements for all countries 88
 - requirements for specific countries and regions 88
 - set requirements 88
- power light, identifying 11
- power requirements, product description 4
- primary storage
 - product description 2
- processor
 - product description 1
- processor, product description 1
- product description
 - audio 2
 - display panel 2
 - graphics controller 1
 - hard drive 2
 - keyboard 3
 - memory module 2
 - microphone 2
 - operating system 4
 - pointing device 3
 - ports 3
 - power requirements 4
 - primary storage 2
 - product name 1
 - RJ-45 (network) 2
 - security 4
 - sensors 3
 - serviceability 4
 - solid-state drive 2
 - video 2
 - wireless 2
- product name 1
- product name and number, computer 16

R

- rear components 14
- recovery 82
 - discs 83
 - media 83
 - USB flash drive 83
- recovery media 82
 - creating using HP Cloud Recovery Download Tool 82
 - creating using Windows tools 82
- regulatory information
 - regulatory label 16
 - wireless certification labels 16

- Remote HP PC Hardware
 - Diagnostics UEFI settings
 - customizing 81
 - using 80
 - removal and replacement
 - procedures 35, 39
 - solid-state drive 35
 - restoring 82
 - restoring and recovery
 - methods 83
 - right control zone, identifying 9
 - right side components 5
 - RJ-45 (network)
 - product description 2
 - RJ-45 (network) jack door
 - illustrated 21
 - removal 50
 - spare part number 21
 - spare part numbers 50
 - RJ-45 (network) jack,
 - identifying 6, 15
 - RJ-45 (network) status lights,
 - identifying 6, 15
- S**
- security, product description 4
- sensors
 - product description 3
- serial number, computer 16
- service labels, locating 16
- servicability, product
 - description 4
- solid-state drive
 - illustrated 21
 - product description 2
 - removal and replacement 35
 - spare part numbers 21
 - specifications 86
- spare part country codes 71
- speaker
 - illustrated 20
 - removal 45
 - spare part number 20, 45
- speakers 16
- special keys
 - identifying 11
 - using 11
- specifications
 - computer 85
 - display 85, 86
 - hard drive 85
 - solid-state drive 86
- static electricity 26, 27
- support information 33
- system board
 - illustrated 20
 - removal 50
 - spare part numbers 20, 50
- system restore 83
- system restore point, creating 82
- T**
- top cover with keyboard
 - spare part numbers 71
- touchpad
 - illustrated 20
 - removal 59
 - settings 9
 - spare part numbers 20, 59
- touchpad buttons
 - identifying 9, 10
- touchpad components 9
- touchpad light, identifying 9, 11
- touchpad settings, adjusting 9
- touchpad zone, identifying 9, 10
- transporting guidelines 26, 32
- traveling with the computer 16
- U**
- USB board
 - illustrated 21
 - removal 47, 50
 - spare part number 21
 - spare part numbers 47, 50
- USB port with HP Sleep and
 - Charge, identifying 6, 7
- USB port, identifying 5
- USB SuperSpeed port,
 - identifying 15
- USB Type-C port with HP Sleep and
 - Charge, identifying 5, 7
- V**
- vents, identifying 6, 7, 14, 16
- video, product description 2
- W**
- wake-on-voice 8
- Windows
 - backup 82
 - recovery media 82
 - system restore point 82
- Windows application key,
 - identifying 12
- Windows key, identifying 12
- Windows tools, using 82
- wireless antennas, identifying 9
- wireless certification label 16
- wireless, product description 2
- WLAN antenna kit
 - illustrated 24
 - spare part number 24
- WLAN antennas, identifying 9
- WLAN device 16
- WLAN label 16
- WLAN module
 - removal 42, 44
 - spare part numbers 42, 44
- workstation guidelines 26