



# Maintenance and Service Guide

## OMEN 16 inch Gaming Laptop PC

### 16-ap0xxx

#### **SUMMARY**

This guide provides maintenance information about such topics as spare parts, removal and replacement of parts, security, and backing up.



# Legal information

© Copyright 2025 HP Development Company, L.P.

AMD and Ryzen are trademarks of Advanced Micro Devices, Inc. Bluetooth is a trademark owned by its proprietor and used by HP Inc. under license. Chrome and Google are trademarks of Google LLC. Intel and Thunderbolt are trademarks of Intel Corporation or its subsidiaries in the U.S. and/or other countries. Microsoft and Windows are either registered trademarks or trademarks of Microsoft Corporation in the United States and/or other countries. NVIDIA, GeForce RTX, and Optimus are trademarks and/or registered trademarks of NVIDIA Corporation in the U.S. and other countries. USB Type-C, USB-C, the USB 5 Gbps port logo, and the USB 10 Gbps port logo are trademarks or registered trademarks of USB Implementers Forum. DisplayPort and the DisplayPort logo are trademarks owned by the Video Electronics Standards Association (VESA) in the United States and other countries. Miracast and Wi-Fi are registered trademarks of Wi-Fi Alliance.

The information contained herein is subject to change without notice. The only warranties for HP products and services are set forth in the express warranty statements accompanying such products and services. Nothing herein should be construed as constituting an additional warranty. HP shall not be liable for technical or editorial errors or omissions contained herein.

First Edition: March 2025

Document Part Number: P19738-001

## Product notice

This guide describes features that are common to most models. Some features may not be available on your computer.

Not all features are available in all editions or versions of Windows. Systems may require upgraded and/or separately purchased hardware, drivers, software or BIOS update to take full advantage of Windows functionality. Windows is automatically updated, which is always enabled. High-speed internet and Microsoft account required. ISP fees may apply and additional requirements may apply over time for updates. See <http://www.microsoft.com>.

**If your product ships with Windows in S Mode:** Windows in S Mode works exclusively with apps from the Microsoft Store within Windows. Certain default settings, features, and apps cannot be changed. Some accessories and apps that are compatible with Windows may not work (including some antivirus, PDF writers, driver utilities, and accessibility apps), and performance may vary, even if you switch out of S Mode. If you switch to Windows, you cannot switch back to S Mode. Learn more at [Windows.com/SmodeFAQ](http://Windows.com/SmodeFAQ).

To access the latest user guides, go to <http://www.hp.com/support>, and follow the instructions to find your product. Then select **Setup & User Guides**.

To help us improve this document, please send any suggestions, comments, or errors to <mailto:hp.doc.feedback@hp.com>. Include the document part number when submitting your feedback.

## Software terms

By installing, copying, downloading, or otherwise using any software product preinstalled on this computer, you agree to be bound by the terms of the HP End User License Agreement (EULA). If you do not accept these license terms, your sole remedy is to return the entire unused product (hardware and software) within 14 days for a full refund subject to the refund policy of your seller.

For any further information or to request a full refund of the price of the computer, please contact your seller.

## Safety warning notice

Reduce the possibility of heat-related injuries or of overheating the computer by following the practices described.

---

 **WARNING!** To reduce the possibility of heat-related injuries or of overheating the mobile computer, do not place the mobile computer directly on your lap or obstruct the computer air vents. Use the mobile computer only on a hard, flat surface. Do not allow another hard surface, such as an adjoining optional printer; or a soft surface, such as pillows or rugs or clothing, to block airflow. Also, do not allow the AC adapter to contact the skin or a soft surface, such as pillows or rugs or clothing, during operation. The computer and AC adapter provided by HP comply with the user-accessible surface temperature limits defined by applicable safety standards.

---

## Important notice about Customer Self-Repair parts

Your computer includes Customer Self-Repair parts and parts that should be accessed only by an authorized service provider.

 **IMPORTANT:** See [Removal and replacement procedures for Customer Self-Repair parts on page 37](#) for details.

Accessing parts described in [Removal and replacement procedures for authorized service provider parts on page 49](#) can damage the computer or void your warranty.

---

# Table of contents

<b>1 Product description</b> .....	<b>1</b>
<b>2 Getting to know your computer</b> .....	<b>7</b>
Right side .....	7
Left side.....	7
Rear .....	9
Display .....	11
Low blue light mode (select products only).....	11
IMAX Enhanced Mode (select products only) .....	11
Wake-on-voice (select products only).....	11
Keyboard area .....	13
Touchpad settings and components .....	13
Touchpad settings .....	13
Adjusting touchpad settings.....	13
Turning on the touchpad .....	13
Touchpad components .....	13
Lights .....	14
Special keys.....	15
HP OMEN Gaming Hub .....	17
OMEN Gaming Hub Graphics Mode (select products only).....	18
Bottom .....	18
Labels .....	19
<b>3 Illustrated parts catalog</b> .....	<b>21</b>
Computer major components.....	21
Display assembly subcomponents.....	24
Cables.....	25
Miscellaneous parts.....	25
<b>4 Removal and replacement procedures preliminary requirements</b> .....	<b>27</b>
Tools required .....	27
Service considerations.....	28
Plastic parts.....	28
Cables and connectors.....	28
Drive handling .....	28

Electrostatic discharge information.....	29
Generating static electricity.....	29
Preventing electrostatic damage to equipment.....	30
Personal grounding methods and equipment.....	30
Grounding the work area.....	30
Recommended materials and equipment.....	31
Cleaning your computer.....	32
Enabling HP Easy Clean (select products only).....	32
Removing dirt and debris from your computer.....	32
Cleaning your computer with a disinfectant.....	33
Caring for wood veneer (select products only).....	34
Packaging and transporting guidelines.....	34
Accessing support information.....	34
<b>5 Removal and replacement procedures for Customer Self-Repair parts.....</b>	<b>37</b>
Component replacement procedures.....	38
Preparation for disassembly.....	38
Bottom cover.....	38
Battery.....	39
Removing and reinstalling the same battery.....	40
Installing a new battery.....	41
Memory modules.....	46
Solid-state drive.....	47
<b>6 Removal and replacement procedures for authorized service provider parts.....</b>	<b>49</b>
Component replacement procedures.....	50
Speakers.....	50
Audio board.....	51
Touchpad.....	51
Heat sink.....	53
Fans.....	55
WLAN module.....	55
USB board (left).....	57
USB board (right).....	58
System board.....	59
Infrared board.....	62
Display assembly.....	63
Keyboard with top cover.....	69
<b>7 Using Setup Utility (BIOS).....</b>	<b>71</b>
Starting Setup Utility (BIOS).....	71
Updating Setup Utility (BIOS).....	72
Determining the BIOS version.....	72
Preparing for a BIOS update.....	72
Downloading a BIOS update.....	73
Installing a BIOS update.....	73
<b>8 Backing up, restoring, and recovering.....</b>	<b>74</b>

Backing up information and creating recovery media.....	75
Using Windows tools for backing up.....	75
Using the HP Cloud Recovery Download Tool to create a recovery USB flash drive (select products only).....	75
Restoring and recovering your system.....	76
Creating a system restore .....	76
Restoring and recovery methods.....	76
Recovering using the HP Recovery USB flash drive.....	76
Changing the computer boot order .....	77
Using HP Sure Recover (select products only).....	77
<b>9 Using HP PC Hardware Diagnostics.....</b>	<b>78</b>
Using HP PC Hardware Diagnostics Windows (select products only).....	79
Using an HP PC Hardware Diagnostics Windows hardware failure ID code.....	79
Accessing HP PC Hardware Diagnostics Windows.....	79
Accessing HP PC Hardware Diagnostics Windows from HP Support Assistant.....	79
Accessing HP PC Hardware Diagnostics Windows from the Start menu (select products only).....	79
Downloading HP PC Hardware Diagnostics Windows.....	80
Downloading the latest HP PC Hardware Diagnostics Windows version from HP.....	80
Downloading the HP PC Hardware Diagnostics Windows from the Microsoft Store.....	80
Downloading HP Hardware Diagnostics Windows by product name or number (select products only).....	80
Installing HP PC Hardware Diagnostics Windows.....	81
Using HP PC Hardware Diagnostics UEFI.....	82
Using an HP PC Hardware Diagnostics UEFI hardware failure ID code.....	82
Starting HP PC Hardware Diagnostics UEFI.....	82
Starting HP PC Hardware Diagnostics UEFI through HP Hotkey Support software (select products only).....	83
Downloading HP PC Hardware Diagnostics UEFI to a USB flash drive.....	83
Downloading the latest HP PC Hardware Diagnostics UEFI version.....	83
Downloading HP PC Hardware Diagnostics UEFI by product name or number (select products only).....	84
Using Remote HP PC Hardware Diagnostics UEFI settings (select products only).....	85
Downloading Remote HP PC Hardware Diagnostics UEFI.....	85
Downloading the latest Remote HP PC Hardware Diagnostics UEFI version.....	85
Downloading Remote HP PC Hardware Diagnostics UEFI by product name or number.....	85
Customizing Remote HP PC Hardware Diagnostics UEFI settings.....	85
<b>10 Specifications.....</b>	<b>87</b>
Computer specifications.....	87
Display specifications.....	88
Solid-state drive specifications .....	88
<b>11 Power cord set requirements.....</b>	<b>90</b>
Requirements for all countries .....	90
Requirements for specific countries and regions.....	90
<b>12 Swelling or deformation of notebook battery.....</b>	<b>93</b>

Swollen notebook batteries .....	94
Swollen battery is not a safety issue .....	94
Discontinue using a swollen battery .....	94
Replace a swollen battery .....	94
Minimize battery swelling.....	95
HP Adaptive Battery Optimizer (consumer notebooks).....	95
HP Battery Health Manager (commercial notebooks).....	95
<b>13 Recycling.....</b>	<b>96</b>
<b>Index.....</b>	<b>97</b>

# 1 Product description

This table provides detailed product information.

**Table 1-1 Product components and their descriptions**

Category	Description
<b>Product Name</b>	OMEN 16 inch Gaming Laptop PC
	Model number: 16-ap0xxx
	CTO model number: 16t-ap0xxx
<b>Processors</b>	<b>AMD® Ryzen™ AI series</b>
	AMD Ryzen AI 5 340
	AMD Ryzen AI 7 350
	AMD Ryzen AI 9 365
	AMD Ryzen AI 5 H 340
	AMD Ryzen AI 7 H 350
	AMD Ryzen AI 9 H 365
<b>Graphics</b>	<b>Internal graphics</b>
	NVIDIA GeForce RTX 4050
<b>Display</b>	<b>40.6 cm (16 in), antiglare, narrow bezel, ultrawide viewing angle (UWVA), flat panel, panel self-refresh (PSR)</b>
	Ultra high-definition (UHD) (2560 × 1600), sRGB 100, low blue light, eDP 1.4 DDS, 500 nits, 240Hz
	WUXGA (1920x1200), sRGB 100, low blue light, eDP1.4 DDS, 400 nits, 165Hz
	WUXGA (1920x1200), sRGB 62.5, eDP 1.4+PSR2, 300 nits, 144Hz
<b>Memory</b>	Two customer-accessible memory module slots (small outline dual in-line memory modules (SODIMMs) supporting up to 32 GB of RAM
	DDR5-5600 and DDR5-5200 dual-channel support
	Supports the following configurations:
	<ul style="list-style-type: none"><li>• 32 GB (16 × 2)(for use in the People's Republic of China[PRC])</li><li>• 24 GB (12 × 2)</li><li>• 16 GB (8 × 2, 16 × 1)</li></ul>

**Table 1-1 Product components and their descriptions (continued)**

Category	Description
	<ul style="list-style-type: none"> <li>12 GB (12 × 1) (select products only)</li> </ul>
	<ul style="list-style-type: none"> <li>8 GB (8 × 1)</li> </ul>
<b>Primary storage</b>	<b>PCIe, Non-Volatile Memory Express (4 × 4 NVMe), M.2 2280 or 2230 solid-state drives</b>
	<ul style="list-style-type: none"> <li>1 TB</li> </ul>
	<ul style="list-style-type: none"> <li>512 GB</li> </ul>
	<ul style="list-style-type: none"> <li>256 GB</li> </ul>
<b>Audio and video</b>	Dual speakers
	HP Audio Boost
	Support for DTS: X Ultra
	Support for HyperX
	Support for XiaoWei
	<b>HP True Vision FHD Camera:</b> indicator LED,1x IR LED USB 2.0, HD BSI sensor, f2.0, WDR/TNR, 80° NFOV
	1080p by 30 frames per second
	Support Windows Hello
	Dual-array digital microphone with appropriate software: beam forming, echo cancellation, noise suppression
<b>RJ-45 (network) jack</b>	Integrated 10/100/1000 NIC
<b>Wireless</b>	<b>Wireless Local Area Network (WLAN)</b>
	Mediatek Tequini2 RZ626 Wi-Fi 6E + Bluetooth 5.3 M.2
	Realtek 11ax Wi-Fi 6 Bluetooth 5.4 WLAN
	Compatible with Miracast® devices
	Bluetooth audio offload
	Dynamic Antenna Gain (Wi-Fi)
	Dynamic Antenna Gain(BT)
	Support for Modern Standby (connected)
	Wi-Fi BIOS specific absorption rate (SAR)
	UNII-4 5 GHz channel
<b>Ports</b>	Hot plug/unplug and autodetect for correct output to wide-aspect vs. standard aspect video
	HDMI v2.1 supporting the following modes:
	<ul style="list-style-type: none"> <li>8K @ 60Hz</li> </ul>
	<ul style="list-style-type: none"> <li>4K @ 60Hz</li> </ul>
	<ul style="list-style-type: none"> <li>8K @ 30Hz</li> </ul>
	Audio-out (headphone)/audio-in (microphone) combo jack
	USB 3.2 Gen 2 Type C® with Thunderbolt™ (left side) (select products only)
	USB 3.2 Gen 1 Type A (supports HP Sleep & Charge; left side)

**Table 1-1 Product components and their descriptions (continued)**

<b>Category</b>	<b>Description</b>
	USB 3.2 Gen 1 Type A (supports HP Sleep & Charge; right side)
	RJ-45 (network) jack
	AC Smart Pin adapter plug
<b>Keyboard/pointing devices</b>	<b>Keyboard, full size, island-style</b>
	Ceramic white, 4-zone RGB lighting
	Ceramic white, white lighting
	Shadow black, 4-zone RGB lighting
	Shadow black, white lighting
	<b>Touchpad</b>
	Clickpad with image sensor
	Multitouch gestures enabled
	Precision touchpad support
	Support for Modern Trackpad Gestures
	Taps enabled as default
<b>Power requirements</b>	<b>Battery</b>
	6 cell, 83 Whr, polymer, HP Long Life
	4 cell, 70 Whr, polymer, HP Long Life
	HP Fast Charge Technology
	<b>Smart AC adapters</b>
	230 W, slim barrel, PFC, 4.5 mm
	150 W, slim barrel, PFC, 4.5 mm
	<b>Power cord</b>
	C13, 1.83 m (6 ft)
<b>Security</b>	Supports Trusted Platform Module (TPM) 2.0, firmware based
	Camera privacy cover
<b>Operating system</b>	Windows® 11 Pro
	Windows 11 Pro High End
	Windows 11 Pro High End China
	Windows 11 Pro China
	Windows 11 Pro Value
	Windows 11 Pro Value China
	Windows 11 Pro Entry
	Windows 11 Pro Entry China
	Windows 11 Home 64 Desktop AIO Chinese Market CPPP

**Table 1-1 Product components and their descriptions (continued)**

<b>Category</b>	<b>Description</b>
	<b>Windows 11 Home in S Mode for Developed Markets (ML)</b>
	Windows 11 Home in S Mode Advanced ML
	Windows 11 Home in S Mode Plus ML
	Windows 11 Home in S Mode ML
	Windows 11 Home in S Mode Value ML
	Windows 11 Home in S Mode Entry ML
	<b>Windows 11 Home in S Mode for Emerging Markets (EM/SL)</b>
	Windows 11 Home in S Mode Advanced SL
	Windows 11 Home in S Mode Plus SL
	Windows 11 Home in S Mode SL
	Windows 11 Home in S Mode Value SL
	Windows 11 Home in S Mode Entry SL
	<b>Windows 11 Home in S Mode for China Market</b>
	Windows 11 Home in S Mode High End CPPP
	Windows 11 Home in S Mode CPPP
	<b>Windows 11 Home in S Mode for APAC Markets</b>
	Windows 11 Home in S Mode Plus SL APAC PPP
	Windows 11 Home in S Mode SL APAC PPP
	Windows 11 Home in S Mode Value SL APAC PPP
	Windows 11 Home in S Mode Entry SL APAC PPP
	<b>Windows 11 Home in S Mode for Africa Markets</b>
	Windows 11 Home in S Mode SL Africa PPP
	<b>Windows 11 Home in S Mode for Indonesia Market</b>
	Windows 11 Home in S Mode Plus SL Indonesia PPP (IDPPP)
	Windows 11 Home in S Mode SL Indonesia PPP (IDPPP)
	Windows 11 Home in S Mode Value SL Indonesia PPP (IDPPP)
	Windows 11 Home in S Mode Entry SL Indonesia PPP (IDPPP)
	<b>Windows 11 Home in S Mode for India Market</b>
	Windows 11 Home in S Mode Plus SL India PPP (IPPP)
	Windows 11 Home in S Mode SL India PPP (IPPP)
	Windows 11 Home in S Mode Value SL India PPP (IPPP)
	Windows 11 Home in S Mode Entry SL India PPP (IPPP)
	<b>Windows 11 Home for Developed Market (ML)</b>
	Windows 11 Home Advanced ML

**Table 1-1 Product components and their descriptions (continued)**

<b>Category</b>	<b>Description</b>
	Windows 11 Home Plus ML
	Windows 11 Home ML
	<b>Windows 11 Home for Developed Market (ML)</b>
	Windows 11 Home Advanced ML
	Windows 11 Home Plus ML
	Windows 11 Home ML
	<b>Windows 11 Home for Emerging Market (EM/SL)</b>
	Windows 11 Home Advanced SL
	Windows 11 Home Plus SL
	Windows 11 Home SL
	Windows 11 Home Value SL
	Windows 11 Home Entry SL
	<b>Windows 11 Home for China Market</b>
	Windows 11 Home High End China PPP (CPPP)
	Windows 11 Home China PPP (CPPP)
	<b>Windows 11 Home for India Market</b>
	Windows 11 Home Plus SL India PPP (IPPP)
	Windows 11 Home SL India PPP (IPPP)
	Windows 11 Home Value SL India PPP (IPPP)
	Windows 11 Home Entry SL India PPP (IPPP)
	<b>Windows 11 Home for Indonesia Market</b>
	Windows 11 Home Plus SL Indonesia PPP (IDPPP)
	Windows 11 Home SL Indonesia PPP (IDPPP)
	Windows 11 Home Value SL Indonesia PPP (IDPPP)
	Windows 11 Home Entry SL Indonesia PPP (IDPPP)
	<b>Windows 11 Home for APAC Market</b>
	Windows 11 Home Plus SL APAC PPP
	Windows 11 Home SL APAC PPP
	Windows 11 Home Value SL APAC PPP
	Windows 11 Home Entry SL APAC PPP
	<b>Windows 11 Home for Africa PPP Market</b>
	Windows 11 Home Plus SL Africa PPP
	Windows 11 Home SL Africa PPP
	Windows 11 Home Value SL Africa PPP

**Table 1-1** Product components and their descriptions (continued)

<b>Category</b>	<b>Description</b>
	Windows 11 Home Entry SL Africa PPP
<b>Serviceability</b>	<b>End user replaceable parts</b>
	AC adapter
	Battery
	Memory module
	Solid-state drive

---

## 2 Getting to know your computer

Your computer features top-rated components. This chapter provides details about your components, where they are located, and how they work.

### Right side

Identify the components on the right side of the computer.

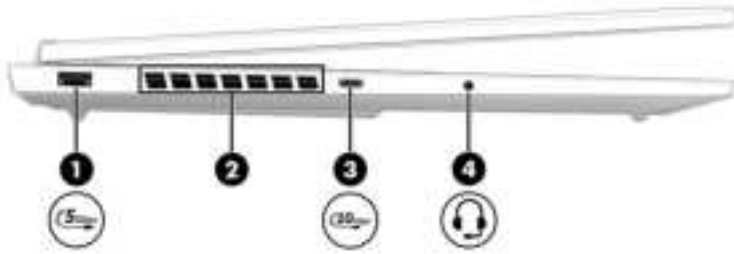

**Table 2-1** Right-side components and their descriptions



	Component	Description
(1)	Vent	Enables airflow to cool internal components.  <b>NOTE:</b> The computer fan starts up automatically to cool internal components and prevent overheating. It is normal for the internal fan to cycle on and off during routine operation.
(2)	 USB 5 Gbps port	Connects a USB device, provides high-speed data transfer, and (for select products) charges small devices (such as a smartphone) when the computer is on or in Sleep mode.  <b>NOTE:</b> Use a standard USB Type-A charging cable or cable adapter (purchased separately) when charging a small external device.

### Left side

Identify the components on the left side of the computer.



**Table 2-2** Left-side components and their descriptions

	Component	Description
(1)	 USB 5 Gbps port	Connects a USB device, provides high-speed data transfer, and (for select products) charges small devices (such as a smartphone) when the computer is on or in Sleep mode.  <b>NOTE:</b> Use a standard USB Type-A charging cable or cable adapter (purchased separately) when charging a small external device.
(2)	Vent	Enables airflow to cool internal components.  <b>NOTE:</b> The computer fan starts up automatically to cool internal components and prevent overheating. It is normal for the internal fan to cycle on and off during routine operation.
(3)	 USB Type-C® 100 W power connector and 10 Gbps port with HP Sleep and Charge and DisplayPort™ output	Connects an AC adapter that has a USB Type-C connector, supplying power to the computer and, if needed, charging the computer battery.  - and -  Connects a USB device, provides high-speed data transfer, and charges small devices (such as a smartphone), even when the computer is off.  <b>NOTE:</b> Use a standard USB Type-C charging cable or cable adapter (purchased separately) when charging a small external device.  - and -  Connects a display device that has a USB Type-C connector, providing DisplayPort output, a DisplayPort connector, or a USB Type-C to DisplayPort adapter.  <b>NOTE:</b> To ensure that your computer operates at full performance and can charge the battery when using resource-intensive applications, use the AC adapter that ships with your computer. Connect the AC adapter to the power connector on the rear of the computer.  You can use an optional 100 W, 20 V USB Type-C adapter or power bank when running light-load tasks. System-off charging is supported only when you use a 20 V USB Type-C adapter or power bank.

**Table 2-2** Left-side components and their descriptions (continued)

	Component	Description
(4)	 Audio-out (headphone)/Audio-in (microphone) combo jack	<p>Connects optional powered stereo speakers, headphones, earbuds, a headset, or a television audio cable. Also connects an optional headset microphone. This jack does not support optional standalone microphones.</p> <p><b>WARNING!</b> To reduce the risk of personal injury, adjust the volume before putting on headphones, earbuds, or a headset. For additional safety information, see the <i>Regulatory, Safety, and Environmental Notices</i>.</p> <p>To access this guide:</p> <ul style="list-style-type: none"> <li>Select the <b>Search</b> icon in the taskbar, type <b>HP Documentation</b> in the search box, and then select <b>HP Documentation</b>.</li> </ul> <p><b>NOTE:</b> When a device is connected to the jack, the computer speakers are disabled.</p>



## Rear

Identify the rear components.

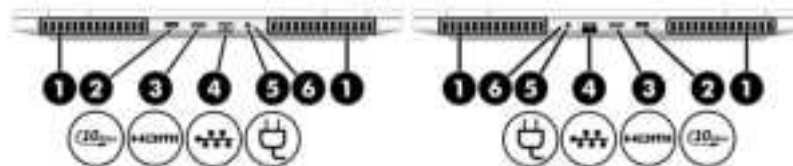

 **NOTE:** Refer to the illustration that most closely matches your computer.



**Table 2-3** Rear components and their descriptions

	Component	Description
(1)	Vents (2)	<p>Enable airflow to cool internal components.</p> <p><b>NOTE:</b> The computer fan starts up automatically to cool internal components and prevent overheating. It is normal for the internal fan to cycle on and off during routine operation.</p>
(2)	 USB 10 Gbps port	<p>Connects a USB device, provides high-speed data transfer, and (for select products) charges small devices (such as a smartphone) when the computer is on or in Sleep mode.</p> <p><b>NOTE:</b> Use a standard USB Type-A charging cable or cable adapter (purchased separately) when charging a small external device.</p>
(3)	 HDMI port	<p>Connects an optional video or audio device, such as a high-definition television, any compatible digital or audio component, or a high-speed High-Definition Multimedia Interface (HDMI) device.</p>

**Table 2-3** Rear components and their descriptions (continued)

	Component	Description
(4)	 RJ-45 (network) jack/status lights	Connects a network cable. <ul style="list-style-type: none"><li>• White: The network is connected.</li><li>• Amber: Activity is occurring on the network.</li></ul>
(5)	 Power connector	Connects an AC adapter.
(6)	AC adapter and battery light	<ul style="list-style-type: none"><li>• White: The AC adapter is connected and the battery is fully charged.</li><li>• Blinking amber: The AC adapter is disconnected and the battery has reached a low battery level.</li><li>• Amber: The AC adapter is connected and the battery is charging.</li><li>• Off: The battery is not charging.</li></ul>

# Display

The computer display can include essential components such as speakers, antennas, cameras, and microphones.

## Low blue light mode (select products only)

Your computer display is shipped from the factory in low blue light mode for improved eye comfort and safety. Also, blue light mode automatically adjusts blue light emissions when you are using the computer at night or for reading.

---

 **WARNING!** To reduce the risk of serious injury, read the *Safety & Comfort Guide*. It describes proper workstation setup and proper posture, health, and work habits for computer users. The *Safety & Comfort Guide* also provides important electrical and mechanical safety information. The *Safety & Comfort Guide* is available on the web at <http://www.hp.com/ergo>.

---

## IMAX Enhanced Mode (select products only)

Select computer models are configured with IMAX Enhanced Mode, a solution built into the hardware and software to enhance the IMAX audio and video experience.

To access the latest setup documentation, go to <http://www.hp.com/support>, type **IMAX** in the **Search our knowledge library** search box, and then select **HP Consumer Notebook PCs - Enabling the IMAX features**.

## Wake-on-voice (select products only)

Use the wake-on-voice feature to bring the computer out of the Sleep state quickly.

---

 **NOTE:** Refer to the illustration that most closely matches your computer.

---

To access the wake-on-voice settings, follow these steps:

1. Select the **Search** icon in the taskbar, type *XiaoWei* in the search box, and then select **XiaoWei**.
2. When the tool opens, scan the QR code with your mobile device, which takes you to the settings page, where you can select your wake-on-voice features.
3. Follow the on-screen instructions.

---

 **NOTE:** Allow the XiaoWei app to continue running on the computer.

---

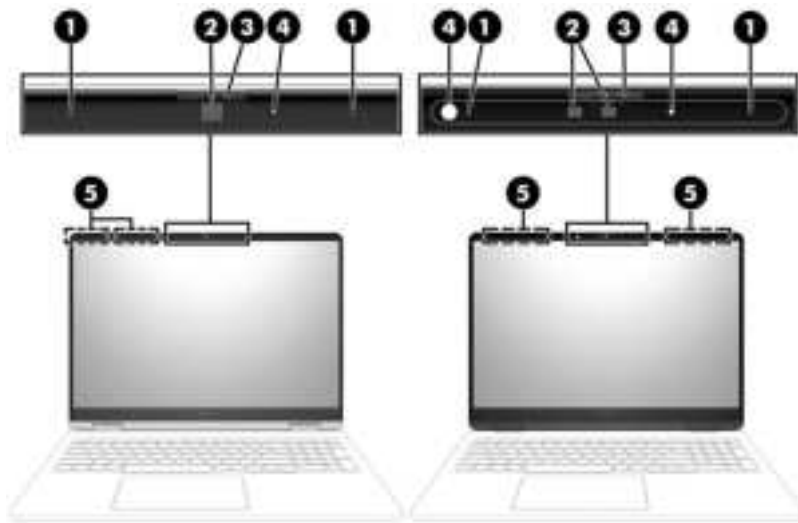

**Table 2-4** Display components and their descriptions

Component	Description
(1) Internal microphones (2)	Record sound.
(2) Cameras	<p>Allow you to video chat, record video, and record still images. Some cameras also allow a facial recognition logon to Windows®, instead of a password logon.</p> <p><b>NOTE:</b> Camera functions vary depending on the camera hardware and software installed on your product.</p> <p><b>NOTE:</b> Depending on your model, your computer might have one or two cameras.</p>
(3) Camera privacy cover	<p>By default, the camera lens is uncovered, but you can slide the camera privacy cover to block the camera's view. To use the camera, slide the camera privacy cover in the opposite direction to reveal the lens.</p> <p><b>NOTE:</b> If you have both front-facing and rear-facing cameras, when one camera lens is revealed and ready to use, the other is concealed.</p>
(4) Camera light(s)	On: One or more cameras are in use.
(5) WLAN antennas*	Send and receive wireless signals to communicate with wireless local area networks (WLANs).

\*The antennas are not visible from the outside of the computer. For optimal transmission, keep the areas immediately around the antennas free from obstructions.

For wireless regulatory notices, see the section of the *Regulatory, Safety, and Environmental Notices* that applies to your country or region.

To access this guide:

- Select the **Search** icon in the taskbar, type `HP Documentation` in the search box, and then select **HP Documentation**.

# Keyboard area

Keyboards can vary by language.

---

 **NOTE:** The keyboard area, including the function keys and (select products only) power key, is disabled in stand, tent, and tablet modes. To enable the keyboard, including the power key, change to the clamshell mode.

---

## Touchpad settings and components

Learn the touchpad settings and components.

### Touchpad settings

Learn how to adjust touchpad settings.

#### Adjusting touchpad settings

Use these steps to adjust touchpad settings and gestures.

1. Select the **Search** icon in the taskbar, type `touchpad settings` in the search box, and then press `enter`.
2. Choose a setting.

#### Turning on the touchpad

Follow these steps to turn on the touchpad.

1. Select the **Search** icon in the taskbar, type `touchpad settings` in the search box, and then press `enter`.
2. Using an external mouse, click the **touchpad** button.

If you are not using an external mouse, press the **Tab** key repeatedly until the pointer rests on the **touchpad** button. Then press the `spacebar` to select the button.

### Touchpad components

Identify the touchpad components.

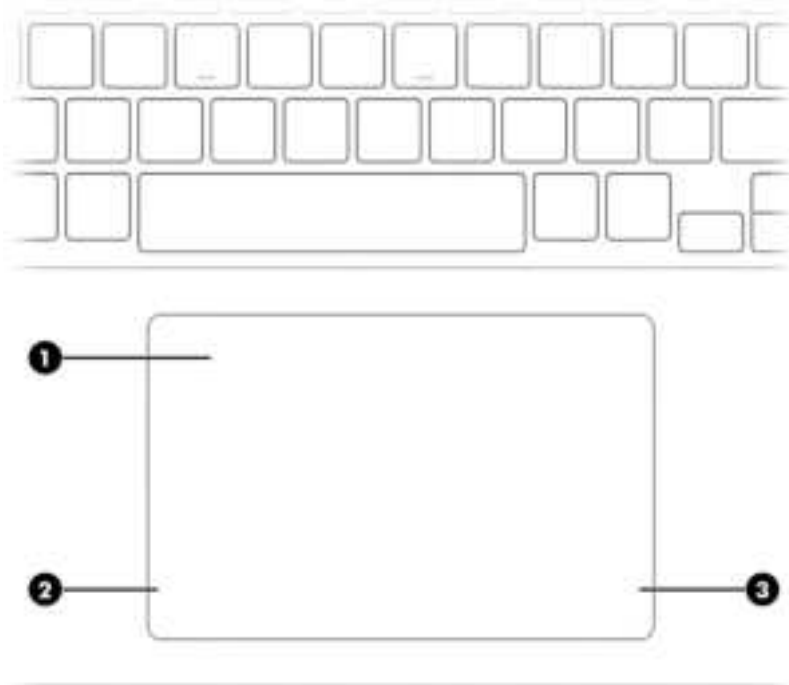
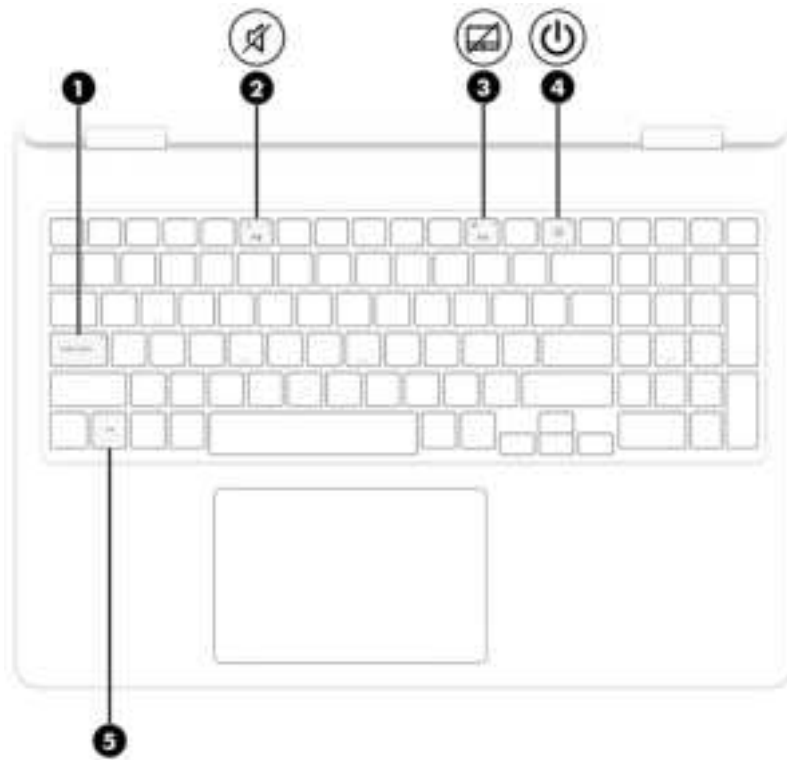

**Table 2-5** Touchpad components and their descriptions



Component	Description
(1) Touchpad zone	Reads your finger gestures to move the pointer or activate items on the screen.
(2) Left touchpad button	Functions like the left button on an external mouse.
(3) Right touchpad button	Functions like the right button on an external mouse.

## Lights

Identify the lights on the computer.

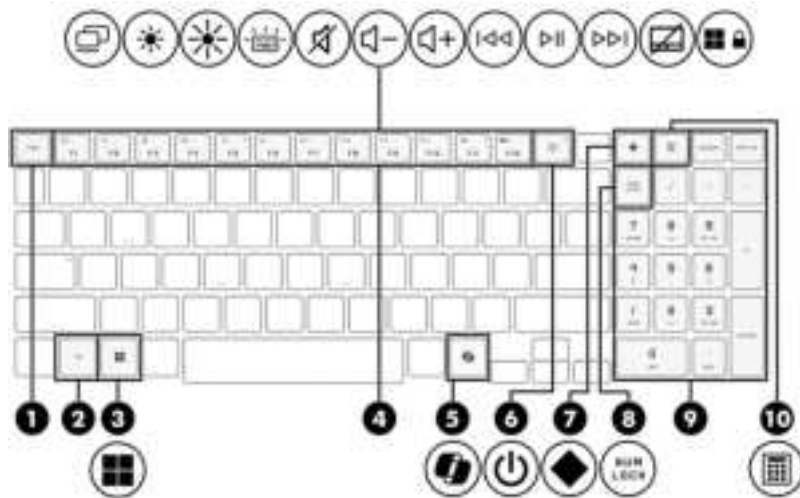

**Table 2-6** Lights and their descriptions



	Component	Description
(1)	Caps lock light	On: Caps lock is on, which switches the key input to all capital letters.
(2)	 Mute light	<ul style="list-style-type: none"> <li>On: Computer sound is off.</li> <li>Off: Computer sound is on.</li> </ul>
(3)	 Touchpad light	<ul style="list-style-type: none"> <li>On: The touchpad is off.</li> <li>Off: The touchpad is on.</li> </ul>
(4)	 Power light	<ul style="list-style-type: none"> <li>On: The computer is on.</li> <li>Blinking (select products only): The computer is in the Sleep state, a power-saving state. The computer shuts off power to the display and other unnecessary components.</li> <li>Off: Depending on your computer model, the computer is off, in Hibernation, or in Sleep. Hibernation is the power-saving state that uses the least amount of power.</li> </ul>
(5)	Fn lock light	On: The <b>fn</b> key is locked.

## Special keys





Identify the special keys.



**Table 2-7** Special keys and their descriptions

	Component	Description
(1)	esc key	Displays system information when pressed in combination with the <b>fn</b> key.
(2)	fn key	Executes specific functions when pressed in combination with another key.
(3)	 Windows key	Opens the Start menu.  <b>NOTE:</b> Pressing the Windows key again will close the Start menu.
(4)	Action keys	Execute frequently used system functions as defined by the icon symbols on <b>f1</b> through <b>f12</b> function keys.
(5)	 Windows Copilot key	Opens Windows Copilot (select products only).  <b>NOTE:</b> Copilot in Windows (select products only) requires Windows 11. Some features require a neural processing unit (NPU). The timing of feature delivery and availability varies by market and device. You must have a Microsoft account to use the Copilot feature. When the Copilot feature is not available, pressing the Copilot key opens the Bing search engine. See <a href="http://aka.ms/WindowsAIFeatures">http://aka.ms/WindowsAIFeatures</a> (in English).

**Table 2-7 Special keys and their descriptions (continued)**

	Component	Description
(6)	 Power button	<ul style="list-style-type: none"> <li>When the computer is off, press the button briefly to turn on the computer.</li> <li>When the computer is on, press the button briefly to initiate Sleep.</li> <li>When the computer is in the Sleep state, press the button briefly to exit Sleep (select products only).</li> <li>When the computer is in Hibernation, press the button briefly to exit Hibernation.</li> </ul> <p><b>IMPORTANT:</b> Pressing and holding down the power button results in the loss of unsaved information.</p> <p>If the computer has stopped responding and shutdown procedures are ineffective, press and hold the power button down for at least 10 seconds to turn off the computer.</p> <p>To learn more about your power and sleep settings:</p> <ul style="list-style-type: none"> <li>Right-click the <b>Power</b> icon , and then select <b>Power and sleep settings</b>.</li> </ul>
(7)	 OMEN key	Opens the OMEN Gaming Hub software.  See <a href="#">HP OMEN Gaming Hub on page 17</a> for more information.
(8)	num lock key	Alternates between the navigational and numeric functions on the integrated numeric keypad.
(9)	Integrated numeric keypad	A separate keypad to the right of the alphabet keyboard. When <b>num lock</b> is pressed, the keypad can be used like an external numeric keypad.  <p><b>NOTE:</b> If the keypad function is active when the computer is turned off, that function is reinstated when the computer is turned back on.</p>
(10)	 Calculator key	Opens the calculator.

## HP OMEN Gaming Hub

HP OMEN Gaming Hub allows you to customize your computer for your specific gaming needs.

To open HP OMEN Gaming Hub, complete one of these tasks:

- Select the **Start** button, select **All apps**, select **OMEN Gaming Hub**, and then follow the on-screen instructions.
- Press the **OMEN** key .

The HP OMEN Gaming Hub dashboard provides a central location to access and configure the following features:

---

 **NOTE:** Some features are available on select products only.

---

- **Cam & Voice Enhancer:** Improve your streaming quality with AI-powered video and audio effects and enhancements (NVIDIA® RTX™ GPUs only).
- **System Vitals:** Monitor the computer status and performance.
- **Light Studio:** Coordinate your color scheme and easily sync your lighting effects across your OMEN devices.
- **Lighting:** Customize the keyboard lighting.
- **Network Booster:** View and adjust network priorities and settings.
- **Performance Control:** Adjust the thermal temperature and power levels of your computer to improve performance.
- **Gaming Device Lighting and Macros:** Configure the lighting and macro keys when an external supported gaming device is connected (select products only).
- **My Games:** Locate and launch games from your library.
- **Graphics Switcher:** Use Graphics Mode to switch between Hybrid or Discrete graphic.
- **Gallery:** View and change your OMEN wallpaper backgrounds.
- **Optimizer:** Boost your game and clean up the clutter on your computer to optimize performance.
- **Key Assignments:** Customize your keyboard by reassigning keys, creating macros and assigning various shortcuts to keys.
- **Help & Resources:** Access various support information and various video guides for your device as well as OMEN Gaming Hub.

---

 **NOTE:** To minimize the dashboard, select the arrow button < at the top of the dashboard.

---

## OMEN Gaming Hub Graphics Mode (select products only)

You can use Graphics Mode in the OMEN Gaming Hub to switch between Hybrid or Discrete graphics.

- **Hybrid**—Use for both integrated and discrete graphics, depending on the app.
- **Discrete**—Use for gaming, media creation, and graphics-intensive tasks (select products only).
- **Integrated Graphics Only**—Use for maximum battery life to turn off discrete GPU and turn on integrated GPU.
- **Advanced Optimus**—Open NVIDIA® Advanced Optimus™ to configure GPU mode automatically (select products only).

## Bottom

Identify the bottom components.

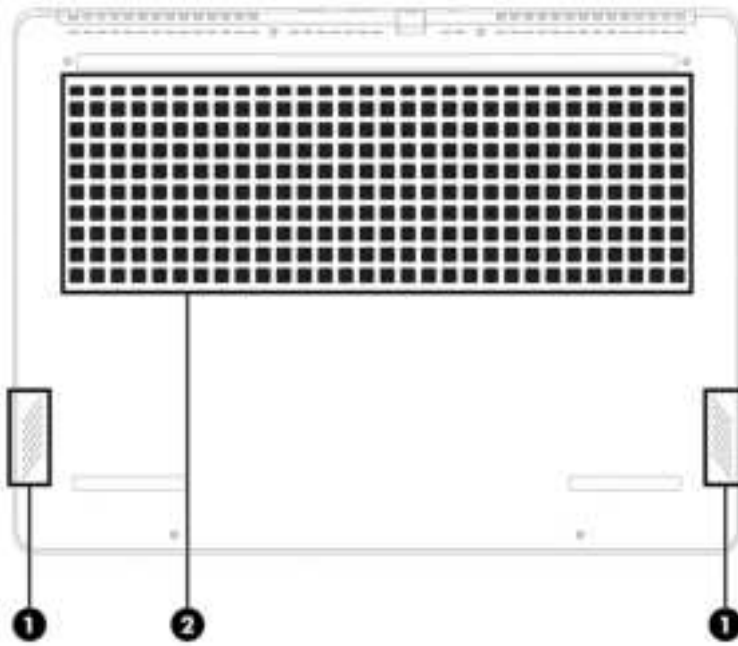

**Table 2-8** Bottom components and their descriptions

	Component	Description
(1)	Speakers (2)	Produce sound.
(2)	Vent	Enables airflow to cool internal components.

**NOTE:** The computer fan starts up automatically to cool internal components and prevent overheating. It is normal for the internal fan to cycle on and off during routine operation.

## Labels

The labels affixed to the computer provide information that you might need when you troubleshoot system problems or travel internationally with the computer. Labels can be in paper form or imprinted on the product.

**IMPORTANT:** Check the following locations for the labels described in this section: the bottom of the computer, inside the battery bay, under the service door, on the back of the display, or on the bottom of a tablet kickstand.

- **Service label**—Provides important information to identify your computer. When contacting support, you might be asked for the serial number, the product number, or the model number. Locate this information before you contact support.

Your service label will resemble the following example.



**Table 2-9** Service label components

Component	
(1)	Serial number
(2)	Product ID
(3)	HP product name and model number

- Regulatory labels—Provide regulatory information about the computer.
- Wireless certification labels—Provide information about optional wireless devices and the approval markings for the countries or regions in which the devices have been approved for use.

---

## 3 Illustrated parts catalog

Use this chapter to determine the spare parts that are available for the computer.

### Computer major components

To identify the computer major components, use this illustration and table.

---

 **NOTE:** HP continually improves and changes product parts. For complete and current information about supported parts for your computer, go to <https://partsurfer.hp.com/>, select your country or region, and then follow the on-screen instructions.

 **NOTE:** Details about your computer, including model, serial number, product key, and length of warranty, are on the service tag at the bottom of your computer.

---

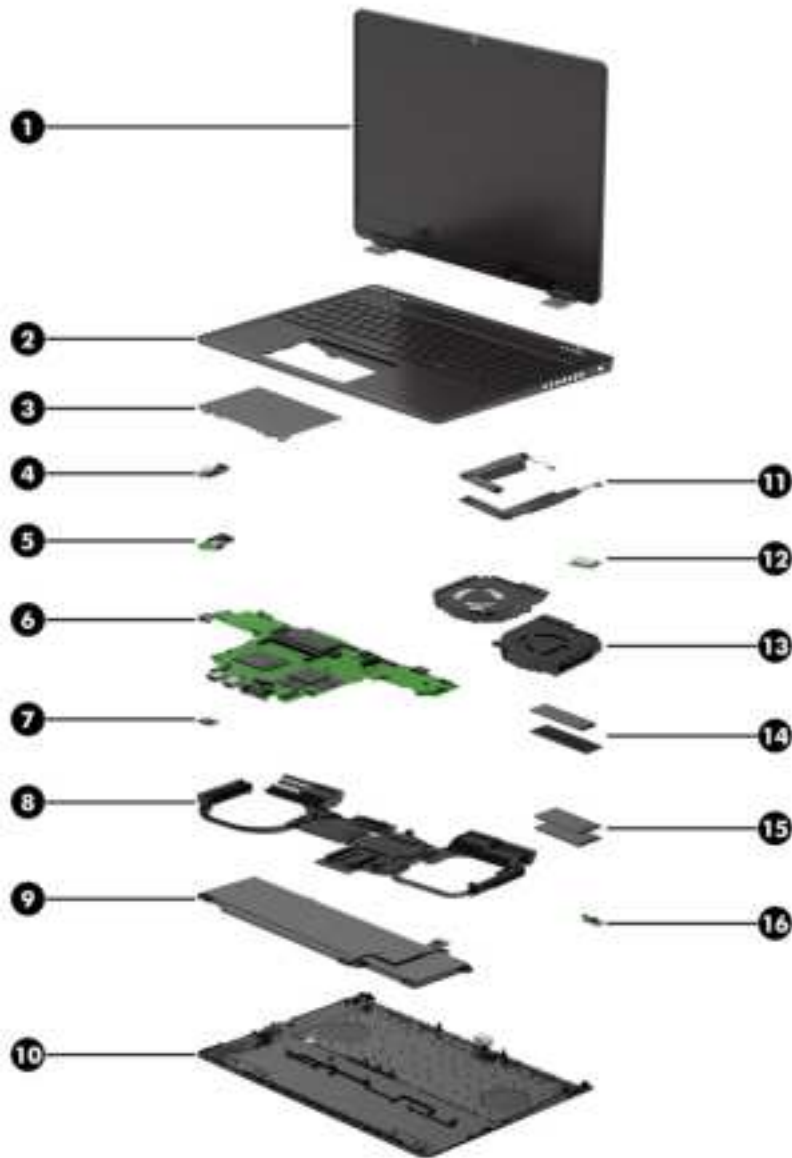

**Table 3-1** Computer major component descriptions and part numbers

Item	Component	Spare part number
(1)	<b>Display assembly</b>  <b>NOTE:</b> Display spare parts are available as subcomponents, not as whole units. Display subcomponent spare parts are available. For spare part information, see <a href="#">Display assembly subcomponents on page 24</a> .	not available as a spare part
(2)	<b>Top cover/keyboard</b>  <b>NOTE:</b> For a detailed list of country codes, see <a href="#">Keyboard with top cover on page 69</a> .	
	Ceramic white, 4-zone RGB backlight	P24302-xxx
	Ceramic white, backlight	P24303-xxx
	Shadow black, 4-zone RGB backlight	P24304-xxx

**Table 3-1 Computer major component descriptions and part numbers (continued)**

Item	Component	Spare part number
	Shadow black, backlight	P24305-xxx
<b>(3)</b>	<b>Touchpad</b>	
	Ceramic white	P23092-001
	Shadow black	P23093-001
<b>(4)</b>	<b>USB board (left)</b>	P23399-001
<b>(5)</b>	<b>USB board (right)</b>	P23086-001
<b>(6)</b>	<b>System board (includes integrated processor)</b>	
	<b>NOTE:</b> All system board spare part kits include replacement thermal material.	
	All system boards use the following part numbers:	
	xxxxxx-001: Non-Windows operating systems	
	xxxxxx-601: Windows operating system	
	AMD Ryzen AI 5 340 processor with NVIDIA GeForce RTX 4050 graphics	P24286-xx1
<b>(7)</b>	<b>Audio board</b>	P23088-001
<b>(8)</b>	<b>Heat sink (includes replacement thermal material)</b>	P24283-001
<b>(9)</b>	<b>Battery</b>	
	6 cell, 83 Whr	P23104-001
<b>(10)</b>	<b>Bottom cover</b>	
	Ceramic white, 83 Whr	P23098-001
	Ceramic white, 70 Whr	P23097-001
	Shadow black, 83 Whr	P23100-001
	Shadow black, 70 Whr	P23099-001
<b>(11)</b>	<b>Speakers</b>	P23101-001
<b>(12)</b>	<b>WLAN module</b>	
	Realtek 11ax Wi-Fi 6 Bluetooth 5.4 WLAN	P06350-005
	Intel AX211 Wi-Fi 6E Bluetooth 5.3 WLAN	N22541-005
<b>(13)</b>	<b>Fans</b>	P23096-001
<b>(14)</b>	<b>Solid-state drive</b>	
	1 TB PCIe-4x4 NVMe NM solid-state drive	N77394-001
	512 GB PCIe-4x4 NVMe NM solid-state drive	N77392-001
<b>(15)</b>	<b>Memory modules (DDR5-5600)</b>	
	16 GB	N77398-001
	8 GB	N77399-001
<b>(16)</b>	<b>Infrared board (includes cable)</b>	P23084-001

# Display assembly subcomponents

To identify the display assembly subcomponents, use this illustration and table.

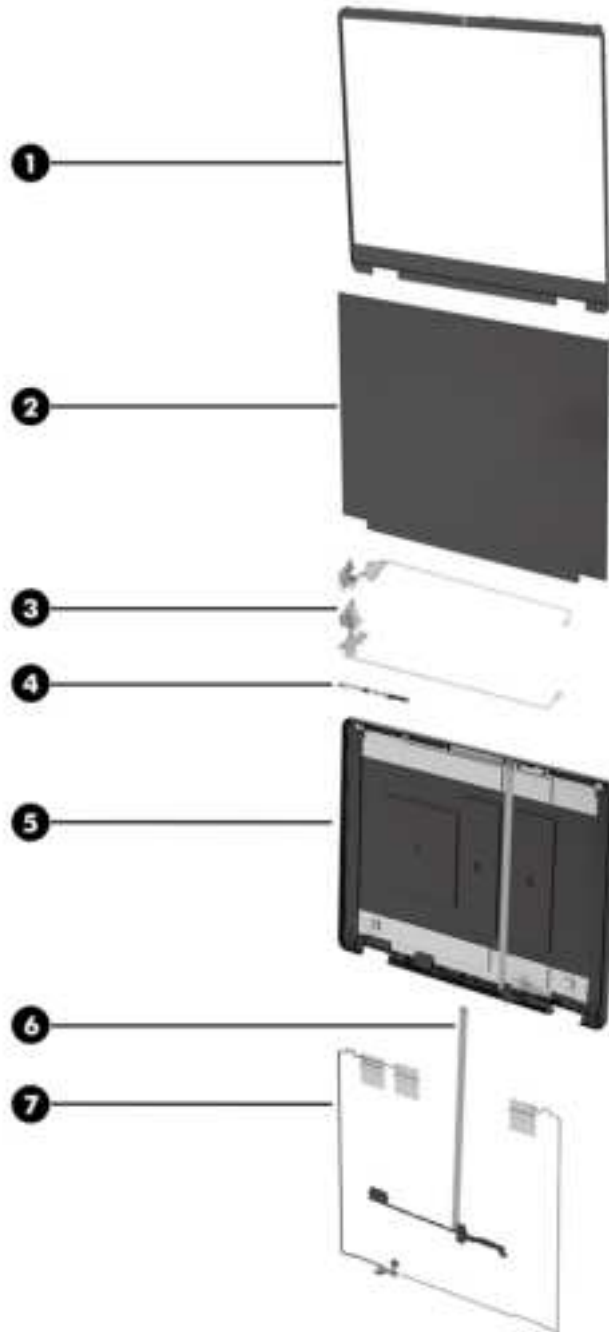

**Table 3-2** Display component descriptions and part numbers

Item	Component	Spare part number
(1)	Display bezel	
	Ceramic white	P23114-001
	Shadow black	P23115-001

**Table 3-2** Display component descriptions and part numbers (continued)

Item	Component	Spare part number
(2)	<b>Display panel</b>	
	Ultrawide viewing angle, 500 nits, 250 Hz	P23077-001
	UWVA, 400 nits, 165 Hz	P23078-001
	UWVA, 300 nits, 144 Hz	P23076-001
(3)	<b>Hinges and side brackets</b> (includes left and right display hinges)	P23119-001
	Hinge caps are available as a set as spare part numbers P23120-001 (ceramic white) and P23121-001 (shadow black).	
(4)	<b>Camera module</b> (includes camera cable and rubber shock absorber)	P23117-001
(5)	<b>Back cover</b> (with WLAN antenna)	
	Ceramic white	P23108-001
	Shadow black	P23110-001
(6)	<b>Cable and antenna kit</b>	P25411-001
(7)	<b>Display panel and camera cable kit</b>	P23118-001

## Cables

To identify the cables, use this table.

**Table 3-3** Cable descriptions and part numbers

Item	Component	Spare part number
(1)	<b>Display panel and camera cable kit</b>	P23118-001
(2)	<b>Cable and antenna kit</b>	P25411-001

## Miscellaneous parts

To identify the miscellaneous parts, use this table.

**Table 3-4** Miscellaneous part descriptions and part numbers

Component	Spare part number
<b>AC adapters</b> (Smart, PFC, slim)	
230 W	N22367-001
<b>Screw Kit</b>	P24284-001
<b>External DVD±RW drive</b>	747080-001
<b>RJ-45 Dropjaw door</b>	P23090-001
<b>Power cords</b> (C13, 1.83 m)	
Australia	M82822-001
Denmark	M82829-001

**Table 3-4** Miscellaneous part descriptions and part numbers (continued)

<b>Component</b>	<b>Spare part number</b>
Europe (Austria, Belgium, Finland, France, Germany, the Netherlands, Norway, and Sweden)	M82827-001
Greece	M82830-001
India	M82824-001
Italy	M82831-001
Japan	M82825-001
North America	M82821-001
The People's Republic of China	M82823-001
South Africa	M82832-001
Switzerland	M82833-001
Taiwan	M82826-001
United Kingdom	M82834-001

---

## 4 Removal and replacement procedures preliminary requirements

Use this information to properly prepare to disassemble and reassemble the computer.

### Tools required

You need the following tools to complete the removal and replacement procedures:

- Tweezers
- Nonconductive, nonmarking pry tool
- Magnetic Phillips P1 screwdriver

## Service considerations

The following sections include some of the considerations that you must keep in mind during disassembly and assembly procedures.

---

 **NOTE:** As you remove each subassembly from the computer, place the subassembly and all accompanying screws away from the work area to prevent damage.

---

### Plastic parts

Using excessive force during disassembly and reassembly can damage plastic parts.

### Cables and connectors

Handle cables with extreme care to avoid damage.

---

 **IMPORTANT:** When servicing the computer, be sure that cables are placed in their proper locations during the reassembly process. Improper cable placement can damage the computer.

---

Apply only the tension required to unseat or seat the cables during removal and insertion. Handle cables by the connector whenever possible. In all cases, avoid bending, twisting, or tearing cables. Be sure that cables are routed so that they cannot be caught or snagged as you remove or replace parts. Handle flex cables with extreme care; these cables tear easily.

### Drive handling

Note the following guidelines when handling drives.

---

 **IMPORTANT:** Drives are fragile components. Handle them with care. To prevent damage to the computer, damage to a drive, or loss of information, observe these precautions:

- Before removing or inserting a hard drive, shut down the computer. If you are unsure whether the computer is off or in Hibernation or Sleep mode, turn the computer on, and then shut it down through the operating system.
  - Before handling a drive, be sure that you are discharged of static electricity. While handling a drive, avoid touching the connector.
  - Before removing an optical drive, be sure that a disc is not in the drive, and be sure that the optical drive tray is closed.
  - Handle drives on surfaces covered with at least 2.54 cm (1 inch) of shock-proof foam.
  - Avoid dropping drives from any height onto any surface.
  - After removing a hard drive or an optical drive, place it in a static-proof bag.
  - Avoid exposing an internal hard drive to products that have magnetic fields, such as monitors or speakers.
  - Avoid exposing a drive to temperature extremes or liquids.
  - If a drive must be mailed, place the drive in a bubble pack mailer or other suitable form of protective packaging, and label the package “FRAGILE.”
-

# Electrostatic discharge information

A sudden discharge of static electricity from your finger or other conductor can destroy static-sensitive devices or microcircuitry. Often the spark is neither felt nor heard, but damage occurs. An electronic device exposed to electrostatic discharge (ESD) might not appear to be affected at all and can work perfectly throughout a normal cycle. The device might function normally for a while, but it has been degraded in the internal layers, reducing its life expectancy.

Networks built into many integrated circuits provide some protection, but in many cases, the discharge contains enough power to alter device parameters or melt silicon junctions.

 **IMPORTANT:** To prevent damage to the device when you remove or install internal components, observe these precautions:

- Keep components in their electrostatic-safe containers until you are ready to install them.
- Before touching an electronic component, discharge static electricity by using the guidelines described in [Personal grounding methods and equipment on page 30](#).
- Avoid touching pins, leads, and circuitry. Handle electronic components as little as possible.
- If you remove a component, place it in an electrostatic-safe container.

## Generating static electricity

Follow these static electricity guidelines:

- Different activities generate different amounts of static electricity.
- Static electricity increases as humidity decreases.

**Table 4-1 Static electricity occurrence based on activity and humidity**

Event	55% relative humidity	40% relative humidity	10% relative humidity
Walking across carpet	7,500 V	15,000 V	35,000 V
Walking across vinyl floor	3,000 V	5,000 V	12,000 V
Motions of bench worker	400 V	800 V	6,000 V
Removing dual in-line packages (DIPs) from plastic tube	400 V	700 V	2,000 V
Removing DIPs from vinyl tray	2,000 V	4,000 V	11,500 V
Removing DIPs from polystyrene foam	3,500 V	5,000 V	14,500 V
Removing bubble pack from PCB (printed circuit board)	7,000 V	20,000 V	26,500 V
Packing PCBs in foam-lined box	5,000 V	11,000 V	21,000 V

 **NOTE:** Multiple electric components can be packaged together in plastic tubes, trays, or polystyrene foam.

As little as 700 V of static electricity can degrade a product.

## Preventing electrostatic damage to equipment

Many electronic components are sensitive to ESD. Circuitry design and structure determine the degree of sensitivity.

The following packaging and grounding precautions are necessary to prevent static electricity damage to electronic components:

- To avoid hand contact, transport products in static-safe containers such as tubes, bags, or boxes.
- Protect all electrostatic parts and assemblies with conductive or approved containers or packaging.
- Keep electrostatic-sensitive parts in their containers until they arrive at static-free stations.
- Place items on a grounded surface before removing them from their container.
- Always be properly grounded when touching a sensitive component or assembly.
- Avoid contact with pins, leads, or circuitry.
- Place reusable electrostatic-sensitive parts from assemblies in protective packaging or conductive foam.

## Personal grounding methods and equipment

Using certain equipment can prevent static electricity damage to electronic components.

- **Wrist straps** are flexible straps with a maximum of  $1\text{ M}\Omega \pm 10\%$  resistance in the ground cords. To provide proper ground, wear a strap snug against bare skin. Verify that the ground cord is connected and fits snugly into the banana plug connector on the grounding mat or workstation.
- You can use **heel straps, toe straps, and boot straps** at standing workstations. These straps are compatible with most types of shoes or boots. On conductive floors or dissipative floor mats, use them on both feet with a maximum of  $1\text{ M}\Omega \pm 10\%$  resistance between the operator and ground.

**Table 4-2** Static shielding protection levels

Method	Voltage
Antistatic plastic	1,500
Carbon-loaded plastic	7,500
Metallized laminate	15,000

## Grounding the work area

To prevent static damage at the work area, follow these precautions:

- Cover the work surface with approved static-dissipative material.
- Use a wrist strap connected to a properly grounded work surface and use properly grounded tools and equipment.
- Use static-dissipative mats, foot straps, or air ionizers to give added protection.
- Handle electrostatic sensitive components, parts, and assemblies by the case or PCB laminate. Handle them only at static-free work areas.
- Turn off power and input signals before inserting and removing connectors or test equipment.

- Use fixtures made of static-safe materials when fixtures must directly contact dissipative surfaces.
- Keep the work area free of nonconductive materials, such as ordinary plastic assembly aids and polystyrene foam.
- Use conductive field service tools, such as cutters, screwdrivers, and vacuums.
- Avoid contact with pins, leads, or circuitry.

## Recommended materials and equipment

HP recommends certain materials and equipment to prevent static electricity:

- Antistatic tape
- Antistatic smocks, aprons, or sleeve protectors
- Conductive bins and other assembly or soldering aids
- Conductive foam
- Conductive tabletop workstations with ground cord of  $1\text{ M}\Omega \pm 10\%$  resistance
- Static-dissipative table or floor mats with hard tie to ground
- Field service kits
- Static awareness labels
- Wrist straps and footwear straps providing  $1\text{ M}\Omega \pm 10\%$  resistance
- Material handling packages
- Conductive plastic bags
- Conductive plastic tubes
- Conductive tote boxes
- Opaque shielding bags
- Transparent metallized shielding bags
- Transparent shielding tubes

# Cleaning your computer

Cleaning your computer regularly removes dirt and debris so that your device continues to operate at its best. Use the following information to safely clean the external surfaces of your computer.

## Enabling HP Easy Clean (select products only)

HP Easy Clean helps you to avoid accidental input while you clean the computer surfaces. This software disables devices such as the keyboard, touch screen, and touchpad for a preset amount of time so that you can clean all computer surfaces.

1. Start HP Easy Clean in one of the following ways:
  - Select the **Start** menu, and then select **HP Easy Clean**.
  - Select the **HP Easy Clean** icon in the taskbar.
  - Select **Start**, and then select the **HP Easy Clean** tile.
2. Now that your device is disabled for a short period, see [Removing dirt and debris from your computer on page 32](#) for the recommended steps to clean the high-touch, external surfaces on your computer. After you remove the dirt and debris, you can also clean the surfaces with a disinfectant. See [Cleaning your computer with a disinfectant on page 33](#) for guidelines to help prevent the spread of harmful bacteria and viruses.

## Removing dirt and debris from your computer

Here are the recommended steps to clean dirt and debris from your computer.

For computers with wood veneer, see [Caring for wood veneer \(select products only\) on page 34](#).

1. Wear disposable gloves made of latex (or nitrile gloves, if you are latex-sensitive) when cleaning the surfaces.
2. Turn off your device and unplug the power cord and other connected external devices. Remove any installed batteries from items such as wireless keyboards.

---

 **CAUTION:** To prevent electric shock or damage to components, never clean a product while it is turned on or plugged in.

---

3. Moisten a microfiber cloth with water. The cloth should be moist, but not dripping wet.

---

 **IMPORTANT:** To avoid damaging the surface, avoid abrasive cloths, towels, and paper towels.

---

4. Wipe the exterior of the product gently with the moistened cloth.

---

 **IMPORTANT:** Keep liquids away from the product. Avoid getting moisture in any openings. If liquid makes its way inside your HP product, it can cause damage to the product. Do not spray liquids directly on the product. Do not use aerosol sprays, solvents, abrasives, or cleaners containing hydrogen peroxide or bleach that might damage the finish.

---

5. Start with the display (if applicable). Wipe carefully in one direction, and move from the top of the display to the bottom. Finish with any flexible cables, like power cord, keyboard cable, and USB cables.
6. Be sure that surfaces have completely air-dried before turning the device on after cleaning.

7. Discard the gloves after each cleaning. Clean your hands immediately after you remove the gloves.

See [Cleaning your computer with a disinfectant on page 33](#) for recommended steps to clean the high-touch, external surfaces on your computer to help prevent the spread of harmful bacteria and viruses.

## Cleaning your computer with a disinfectant

The World Health Organization (WHO) recommends cleaning surfaces, followed by disinfection, as a best practice for preventing the spread of viral respiratory illnesses and harmful bacteria.

After cleaning the external surfaces of your computer using the steps in [Removing dirt and debris from your computer on page 32](#), [Caring for wood veneer \(select products only\) on page 34](#), or both, you might also choose to clean the surfaces with a disinfectant. A disinfectant that is within HP's cleaning guidelines is an alcohol solution consisting of 70% isopropyl alcohol and 30% water. This solution is also known as rubbing alcohol and is sold in most stores.

Follow these steps when disinfecting high-touch, external surfaces on your computer:

1. Wear disposable gloves made of latex (or nitrile gloves, if you are latex-sensitive) when cleaning the surfaces.
2. Turn off your device and unplug the power cord and other connected external devices. Remove any installed batteries from items such as wireless keyboards.

---

 **CAUTION:** To prevent electric shock or damage to components, never clean a product while it is turned on or plugged in.

---

3. Moisten a microfiber cloth with a mixture of 70% isopropyl alcohol and 30% water. The cloth should be moist, but not dripping wet.

---

 **CAUTION:** Do not use any of the following chemicals or any solutions that contain them, including spray-based surface cleaners: bleach, peroxides (including hydrogen peroxide), acetone, ammonia, ethyl alcohol, methylene chloride, or any petroleum-based materials, such as gasoline, paint thinner, benzene, or toluene.

---

 **IMPORTANT:** To avoid damaging the surface, avoid abrasive cloths, towels, and paper towels.

---

4. Wipe the exterior of the product gently with the moistened cloth.

---

 **IMPORTANT:** Keep liquids away from the product. Avoid getting moisture in any openings. If liquid makes its way inside your HP product, it can cause damage to the product. Do not spray liquids directly on the product. Do not use aerosol sprays, solvents, abrasives, or cleaners containing hydrogen peroxide or bleach that might damage the finish.

---

5. Start with the display (if applicable). Wipe carefully in one direction, and move from the top of the display to the bottom. Finish with any flexible cables, like power cord, keyboard cable, and USB cables.
6. Be sure that surfaces have completely air-dried before turning the device on after cleaning.
7. Discard the gloves after each cleaning. Clean your hands immediately after you remove the gloves.

## Caring for wood veneer (select products only)

Your product might feature high-quality wood veneer. As with all natural wood products, proper care is important for best results over the life of the product. Because of the nature of natural wood, you might see unique variations in the grain pattern or subtle variations in color, which are normal.

- Clean the wood with a dry, static-free microfiber cloth or chamois.
- Avoid cleaning products containing substances such as ammonia, methylene chloride, acetone, turpentine, or other petroleum-based solvents.
- Do not expose the wood to sun or moisture for long periods of time.
- If the wood becomes wet, dry it by dabbing with an absorbent, lint-free cloth.
- Avoid contact with any substance that might dye or discolor the wood.
- Avoid contact with sharp objects or rough surfaces that might scratch the wood.

See [Removing dirt and debris from your computer on page 32](#) for the recommended steps to clean the high-touch, external surfaces on your computer. After you remove the dirt and debris, you can also clean the surfaces with a disinfectant. See [Cleaning your computer with a disinfectant on page 33](#) for sanitizing guidelines to help prevent the spread of harmful bacteria and viruses.

## Packaging and transporting guidelines

Follow these grounding guidelines when packaging and transporting equipment:

- To avoid hand contact, transport products in static-safe tubes, bags, or boxes.
- Protect ESD-sensitive parts and assemblies with conductive or approved containers or packaging.
- Keep ESD-sensitive parts in their containers until the parts arrive at static-free workstations.
- Place items on a grounded surface before removing items from their containers.
- Always be properly grounded when touching a component or assembly.
- Store reusable ESD-sensitive parts from assemblies in protective packaging or nonconductive foam.
- Use transporters and conveyors made of antistatic belts and roller bushings. Be sure that mechanized equipment used for moving materials is wired to ground and that proper materials are selected to avoid static charging. When grounding is not possible, use an ionizer to dissipate electric charges.

## Accessing support information

To find the HP support that you need, use this information.

**Table 4-3 Support information locations**

Service consideration	Path to access information
Records of reported failure incidents stored on the computer	<p><b>Windows®:</b></p> <p>Preoperating system failures are logged in the BIOS Event Log. To view the BIOS Event Log:</p> <ol style="list-style-type: none"><li>1. Press the power button.</li><li>2. Immediately and repeatedly press <b>esc</b> when the power button light turns white.</li></ol> <p><b>NOTE:</b> If you do not press <b>esc</b> at the appropriate time, you must restart the computer and again repeatedly press <b>esc</b> when the power button light turns white to access the utility.</p> <ol style="list-style-type: none"><li>3. Press <b>f10</b> to enter the BIOS setup.</li><li>4. Complete one of these tasks:<ul style="list-style-type: none"><li>• (On commercial products) Under the <b>Main</b> tab, select <b>BIOS event log</b>, and then select <b>View BIOS Event Log</b>.</li><li>• (On consumer products) Under the <b>Main</b> tab, select <b>System Log</b>.</li></ul></li></ol> <p>Post-operating system failures are logged in the Event Viewer.</p> <ol style="list-style-type: none"><li>1. Turn on the computer and allow the operating system to open.</li><li>2. Select the search icon  in the taskbar.</li><li>3. Type <code>Event Viewer</code>, and then press <b>enter</b>.</li><li>4. Select the log from the left panel. Details display in the right panel.</li></ol> <p><b>Chrome™:</b></p> <ol style="list-style-type: none"><li>1. Go to <a href="https://support.google.com/chrome">support.google.com/chrome</a>.</li><li>2. Search <code>collect Chrome device logs</code>.</li></ol>
Technical bulletins	<p>To locate technical bulletins:</p> <ol style="list-style-type: none"><li>1. Go to <a href="https://www.hp.com">www.hp.com</a>.</li><li>2. Place the cursor over <b>Problem solving</b> to display more options.</li><li>3. Select <b>Support &amp; Troubleshooting</b>.</li><li>4. Type the serial number, product number, or product name to go to the product support page.</li><li>5. Select <b>Advisories</b> to view technical bulletins.</li></ol>
Repair professionals	<p>To locate repair professionals:</p> <ol style="list-style-type: none"><li>1. Go to <a href="https://www.hp.com">www.hp.com</a>.</li><li>2. Place the cursor over <b>Support resources</b> to display more options.</li><li>3. Select <b>Authorized service providers</b>.</li></ol>



**Table 4-3** Support information locations (continued)

Service consideration	Path to access information
Component and diagnosis information, failure detection, and required action	To locate diagnosis information and actions: <ol style="list-style-type: none"><li data-bbox="676 310 1437 342">1. Go to <a href="http://www.hp.com/go/techcenter/pcdiags">http://www.hp.com/go/techcenter/pcdiags</a>.</li><li data-bbox="676 359 1437 390">2. Select <b>Get Support</b>.</li><li data-bbox="676 407 1437 464">3. Near the bottom of the window, select <b>Notebook PCs</b>, and then select your location.</li></ol>

---

# 5 Removal and replacement procedures for Customer Self-Repair parts

This chapter provides removal and replacement procedures for Customer Self-Repair parts.

- 
-  **NOTE:** The Customer Self-Repair program is not available in all locations. Installing a part that is not supported by the Customer Self-Repair program can void your warranty. Check your warranty to determine whether Customer Self-Repair is supported in your location.
  -  **NOTE:** The [HP Support YouTube Channel](#) (in English) has videos that provide step-by-step removal and replacement instructions for many common parts and models.
-

# Component replacement procedures

To remove and replace computer components, use these procedures.

 **NOTE:** Details about your computer, including model, serial number, product key, and length of warranty, are on the service tag at the bottom of your computer.

 **NOTE:** HP continually improves and changes product parts. For complete and current information about supported parts for your computer, go to <https://partsurfer.hp.com/>, select your country or region, and then follow the on-screen instructions.

Make special note of each screw size and location during removal and replacement.

## Preparation for disassembly

To remove and replace computer components, use these procedures:

For initial safety procedures, see [Removal and replacement procedures preliminary requirements on page 27](#).

1. Turn off the computer. If you are unsure whether the computer is off or in Hibernation or Sleep mode, turn the computer on, and then shut it down through the operating system.
2. Disconnect the power from the computer by unplugging the power cord from the computer.
3. Disconnect all external devices from the computer.

## Bottom cover

To remove the use this procedure and illustration.

**Table 5-1 Bottom cover descriptions and part numbers**

Description	Spare part number
Ceramic White, 83W	P23098-001
Shadow Black, 83W	P23100-001
Ceramic White, 70W	P23097-001
Shadow Black, 70W	P23099-001

Before removing the bottom cover, prepare the computer for disassembly (see [Preparation for disassembly on page 38](#)).

Remove the bottom cover:

1. Loosen the four Phillips M2.0 × 4.0 captive screws at the rear of the bottom cover **(1)**. Then remove the two noncaptive Phillips screws at the front of the computer **(2)**.

 **NOTE:** The bottom cover includes four captive (not removable) screws that cause the cover to pop up when you loosen the screws. **After the cover pops up, do not continue to loosen the captive screws.**

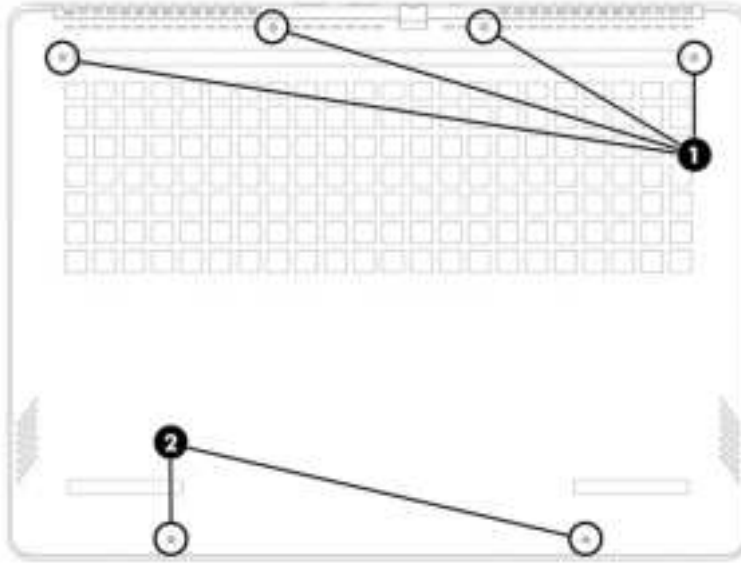

2. Use a nonmarking, nonconductive tool to release the edges of the bottom cover from the computer (1).
3. Remove the bottom cover from the computer (2).



To replace the bottom cover, reverse the removal procedures.

## Battery

The battery removal procedure differs depending on whether you are removing and replacing the existing battery or installing a new battery. To install a new battery, you must use a revive kit.

- To remove and replace the existing battery, see [Removing and reinstalling the same battery on page 40](#).
- To install a new battery, see [Installing a new battery on page 41](#).

## Removing and reinstalling the same battery

To remove the battery and reinstall it, use this procedure and illustration.

---

 **WARNING!** To avoid personal injury and damage to the product:

- Do *not* puncture, twist, or crack the battery.
- Do *not* cause an external puncture or rupture to the battery, which can cause a short inside the battery that can result in battery thermal runaway.
- Do *not* handle or touch the battery enclosure with sharp objects such as tweezers or pliers, which might puncture the battery.
- Do *not* compress or squeeze the battery case with tools or heavy objects stacked on top of the case. These actions can apply undue force on the battery.
- Do *not* touch the connectors with any metallic surface or object, such as metal tools, screws, or coins, which can cause shorting across the connectors.

---

For additional battery information, see the *Regulatory, Safety, and Environmental Notices*. To access this guide, select the **Search** icon in the taskbar, type `HP Documentation` in the search box, and then select **HP Documentation**.

Before removing the battery, follow these steps:

1. Prepare the computer for disassembly (see [Preparation for disassembly on page 38](#)).
2. Remove the bottom cover (see [Bottom cover on page 38](#)).

---

 **WARNING!** To reduce potential safety issues, use only the user-replaceable battery provided with the computer, a replacement battery provided by HP, or a compatible battery purchased from HP.

 **IMPORTANT:** Removing a battery that is the sole power source for the computer can cause loss of information. To prevent loss of information, save your work or shut down the computer through Windows before you remove the battery.

---

Remove the battery:

1. Disconnect the battery cable **(1)** from the system board.
2. Remove the four Phillips M2.0 × 4.0 screws **(2)** that secure the battery to the computer.

3. Remove the battery from the computer (3).

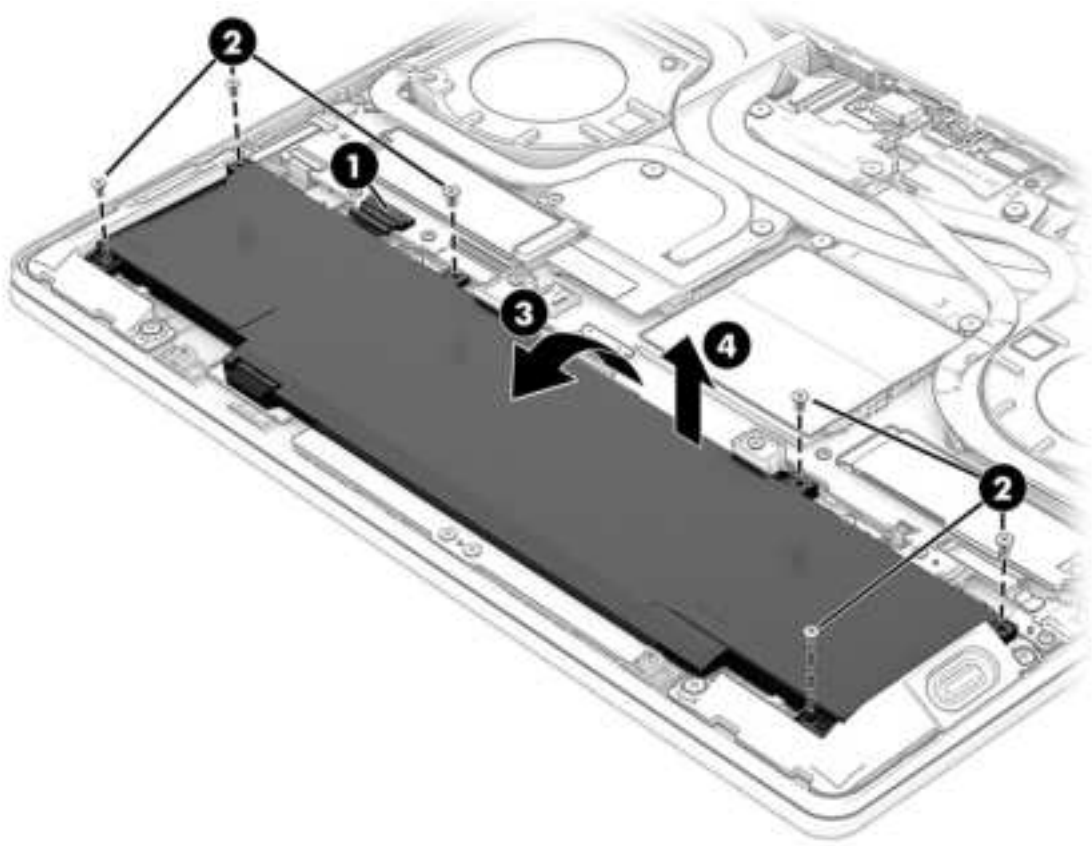

To reinstall the battery, reverse the removal procedures.

 **NOTE:** When reinstalling the battery, be sure to completely reassemble the computer and plug in the AC adapter before turning the computer on.

## Installing a new battery

To install a battery, use these procedures and illustrations. You must use a revive kit to remove the old battery and install a new one. The revive kit includes an empty containment tray and a containment tray with a battery preinstalled.

**Table 5-2** Battery descriptions and part numbers

Description	Spare part number
6 cell, long life, fast charge, 83 Whr, with bracket	P23104-001
4 cell, long life, fast charge, 70 Whr, with bracket	P23103-001

Before starting this replacement procedure:

- Ensure other individuals are sufficiently clear of your workspace.
- Ensure your workspace is clear of any flammable material such as paper or oils.

- Locate the nearest ABC dry chemical fire-extinguisher for use in an emergency.

---

**⚠ WARNING!** This procedure requires removing the battery or disconnecting the battery cable. Use care to avoid bending, twisting, or puncturing the battery regardless of its condition. Failure to follow this replacement guide or to use HP recommended tools might damage the system and/or cause a safety hazard.

- Do *not* remove the battery from the containment tray.
- Do *not* handle or touch the battery enclosure with sharp objects such as tweezers or pliers, which might puncture the battery.
- Do *not* touch the connectors with any metallic surface or object, such as metal tools, screws, or coins, which can cause shorting across the connectors.

---

Should a part become stuck or difficult to remove when opening a unit where a swollen battery is suspected, or if the battery becomes stuck in the unit, stop, and contact HP Support for assistance. Do not try to remove a battery by force.

---

**📄 NOTE:** Screw locations, latch locations, and internal components might vary.

Before removing the battery, follow these steps:

1. Prepare the computer for disassembly (see [Preparation for disassembly on page 38](#)).
2. Remove the bottom cover (see [Bottom cover on page 38](#)).

---

**⚠ WARNING!** To reduce potential safety issues, use only the user-replaceable battery provided with the computer, a replacement battery provided by HP, or a compatible battery purchased from HP.

**📄 IMPORTANT:** Removing a battery that is the sole power source for the computer can cause loss of information. To prevent loss of information, save your work or shut down the computer through Windows before you remove the battery.

1. Remove the battery using the revive kit:
  - a. Disconnect the battery cable from the system board. The connector location might vary.

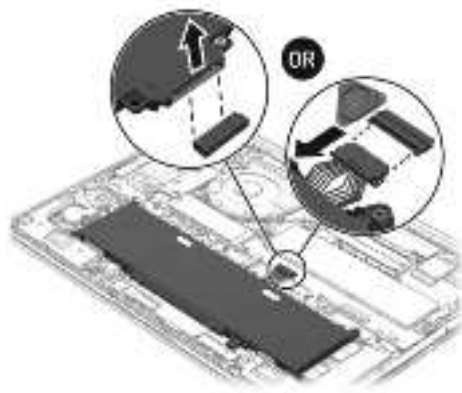

- b. Open the empty battery containment tray.



- c. Remove the paper backing layer from the adhesive on the tray.



- d. Turn the tray (1) over so that the adhesive is facing down.
- e. Place the tray (2) centered on the battery.
- f. Press down on the indentations on the tray (3) to adhere it to the battery.



- g. Remove the Phillips screws (1) that secure the battery to the computer. Number of screws and screw locations might vary.
- h. Lift the top of the tray (2) to remove the battery from the computer.

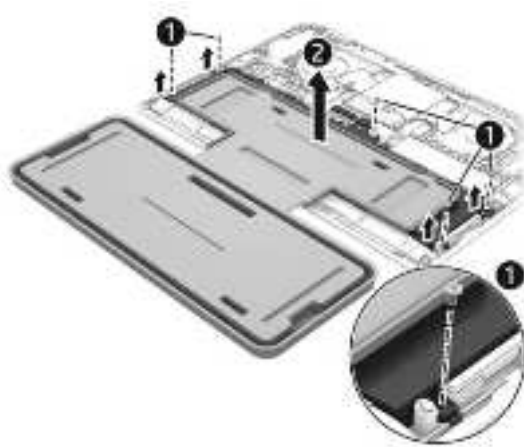

- i. Rotate the battery up and over into the cavity of the containment tray.



---

 **NOTE:** Please recycle responsibly. For more information about recycling programs, see the HP website at <http://www.hp.com/recycle>.

---

- 2. Install the battery using the revive kit:
  - a. Open the containment tray that includes the new battery.

- b. Turn the tray (1) over so the battery is facing downward, and then insert the battery (2) into the computer. Adhesive secures the battery to the tray.

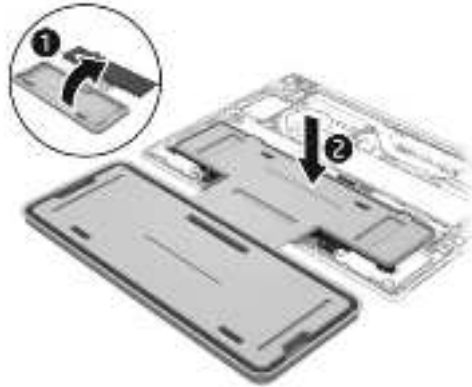

- c. Install the Phillips screws (1) to secure the battery. Number of screws and screw locations might vary.
- d. Lift the containment tray (2) off the battery.



- e. Connect the battery cable to the system board. The connector location might vary.

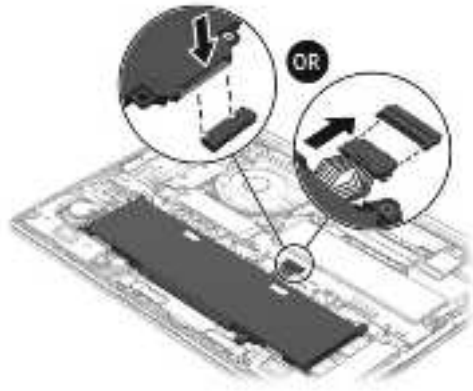

 **NOTE:** When replacing the battery, be sure to completely reassemble the computer and plug in the AC adapter before turning the computer on.

## Memory modules

To remove the memory modules, use this procedure and illustration.

 **NOTE:** Do not remove any labels from factory original memory modules. HP authorized service providers use a commodity tracking number or a vendor serial number printed on memory module labels for limited warranty justification and fraud checking. These numbers are tied to a specific product serial number in the factory and registered by HP for subassembly tracking.

**Table 5-3** Memory module descriptions and part numbers

Description	Spare part number
16 GB, DDR5-5600	N77399-001
8 GB, DDR5-5600	N77398-001

Before removing the memory, follow these steps:

1. Prepare the computer for disassembly (see [Preparation for disassembly on page 38](#)).
2. Remove the bottom cover (see [Bottom cover on page 38](#)).
3. Disconnect the battery cable (see [Battery on page 39](#)).

If you are replacing a memory module, remove the existing memory module:

- Spread the two retention clips outward **(1)** until the memory module tilts up at a 45° angle, and then remove the module **(2)**. Use the same procedure to remove all memory modules.

 **IMPORTANT:** To prevent damage to the memory module, hold the memory module by the edges only. Do not touch the components on the memory module.

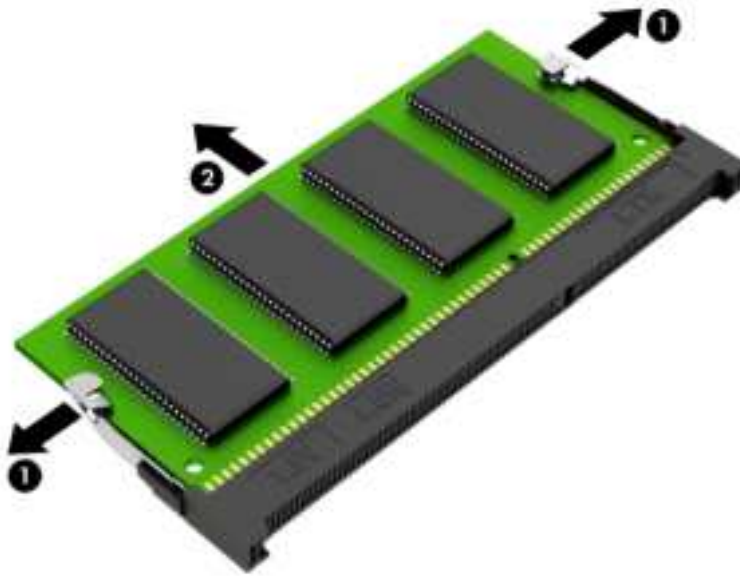

To protect a memory module after removal, place it in an electrostatic-safe container.

To install a memory module:

1. Align the notched edge of the module with the tab in the slot **(1)**, and then press the module into the slot at an angle until it is seated **(2)**.
2. Press down on the module until the side retention clips snap into place **(3)**.

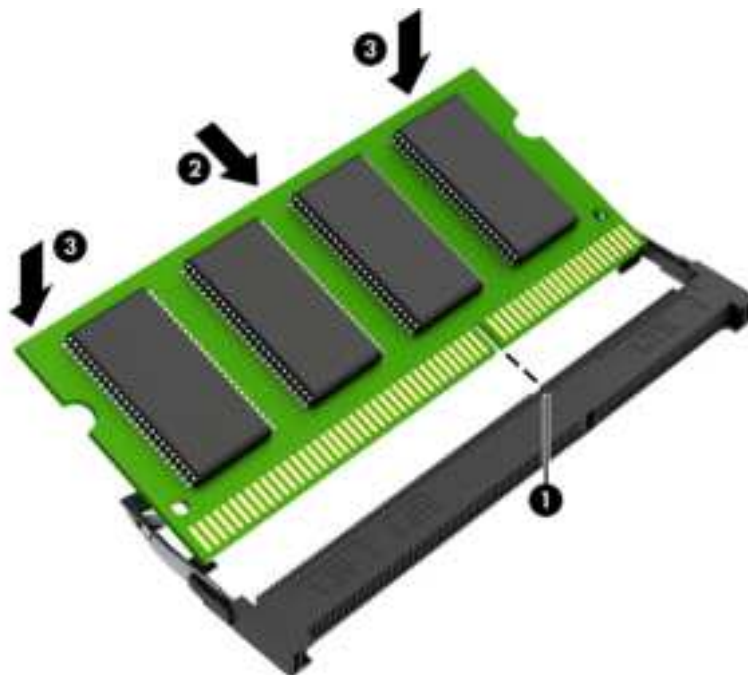

## Solid-state drive

To remove the M.2 solid-state drive, use this procedure and illustration.

**Table 5-4 Solid-state drive descriptions and part numbers**

Description	Spare part number
1 TB, PCIe-4 × 4, NVMe	N77394-001
512 GB, PCIe-4 × 4, NVMe	N77392-001

Before removing the solid-state drive, follow these steps:

1. Prepare the computer for disassembly (see [Preparation for disassembly on page 38](#)).
2. Remove the bottom cover (see [Bottom cover on page 38](#)).
3. Disconnect the battery cable (see [Battery on page 39](#)).

Remove the solid-state drive:

1. Remove the Phillips M2.0 × 3.5 screw (1) on either side that secures the drive you are replacing to the computer.
2. Carefully remove the drive bracket (2), including the thermal pad and the paper backing for the thermal pad.
3. Pull the drive (3) away from the socket to remove it.

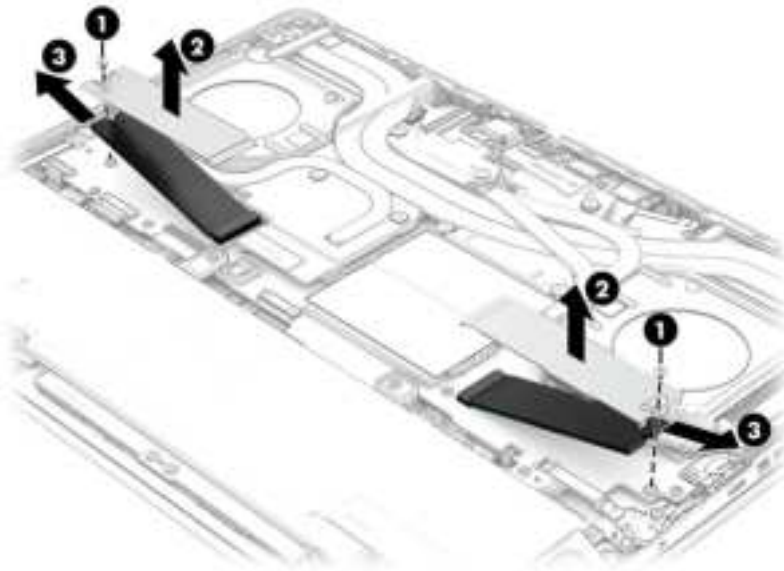



To install the solid-state drive, reverse the removal procedures.

 **NOTE:** Solid-state drives are designed with a notch to prevent incorrect insertion.

---

## 6 Removal and replacement procedures for authorized service provider parts

This chapter provides removal and replacement procedures for authorized service provider parts.

- 
-  **IMPORTANT:** Only an authorized service provider should access the components described in this chapter. Accessing these parts can damage the computer or void the warranty.
  -  **NOTE:** Details about your computer, including model, serial number, product key, and length of warranty, are on the service tag at the bottom of your computer.
  -  **NOTE:** The [HP Support YouTube Channel](#) (in English) has videos that provide step-by-step removal and replacement instructions for many common parts and models.
-

# Component replacement procedures

To remove and replace computer components, use the procedures described in this section.

**NOTE:** HP continually improves and changes product parts. For complete and current information about supported parts for your computer, go to <https://partsurfer.hp.com/>, select your country or region, and then follow the on-screen instructions.

Make special note of each screw size and location during removal and replacement.

## Speakers

To remove the speakers, use this procedure and illustration.

**Table 6-1 Speaker description and part number**

Description	Spare part number
Speakers	P23101-001

Before removing the speakers, follow these steps:

1. Prepare the computer for disassembly (see [Preparation for disassembly on page 38](#)).
2. Remove the bottom cover (see [Bottom cover on page 38](#)).
3. Disconnect the battery from the system board (see [Battery on page 39](#)). Removal of the battery is not required.

Remove the speakers:

1. Disconnect the speaker cables from the system board (1).
2. Remove the four Phillips M1.6 × 2.5 screws (2) that secure the speakers to the computer.
3. Remove the speakers from the computer (3).

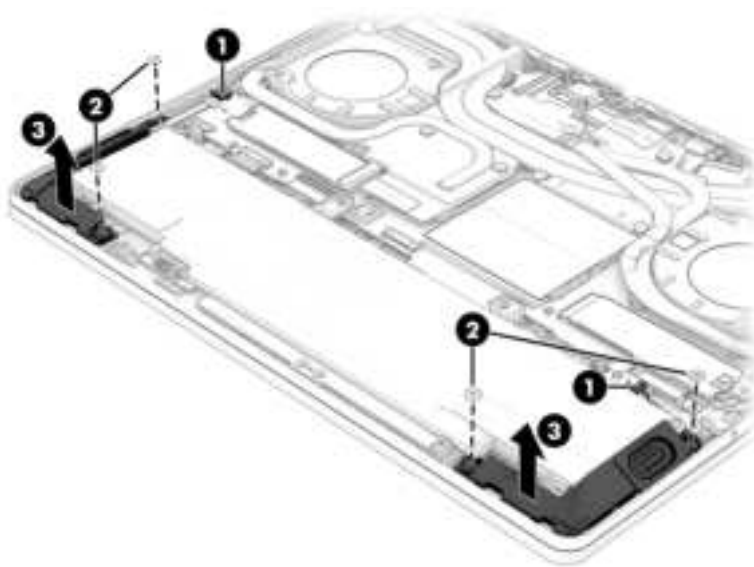

To install the speakers, reverse this procedure.

## Audio board

To remove the audio board, use this procedure and illustration.

**Table 6-2** Audio board descriptions and part numbers

Description	Spare part number
Audio board	P23088-001
Cable kit	P25411-001

Before removing the audio board, follow these steps:

1. Prepare the computer for disassembly (see [Preparation for disassembly on page 38](#)).
2. Remove the bottom cover (see [Bottom cover on page 38](#)).
3. Disconnect the battery (see [Battery on page 39](#)). Removal of the battery is not required.

Remove the audio board:

1. Remove the two Phillips M2.0 × 3.0 screws **(1)** that secure the board to the computer.
2. Disconnect the audio board cable from the ZIF connector **(2)** on each side of the audio board.
3. Remove the audio board **(3)**.
4. Remove the audio board cable **(4)**.

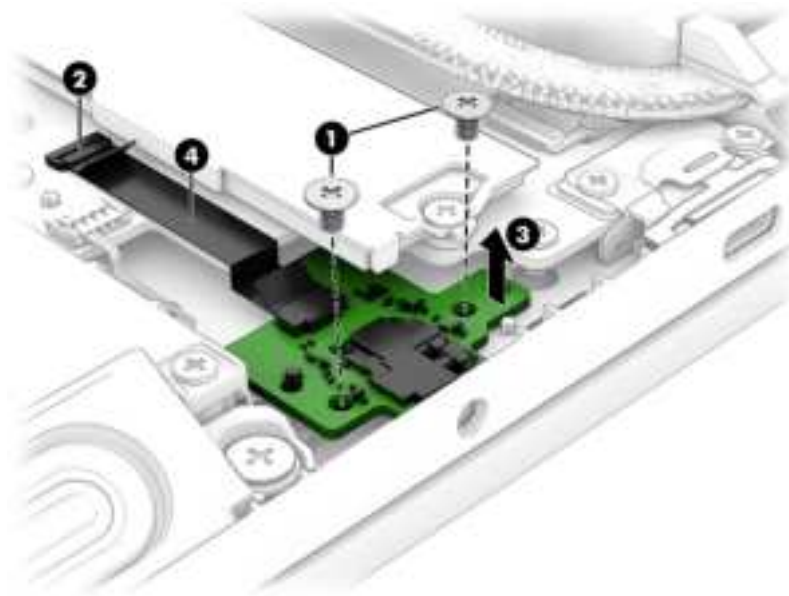

To install the audio board, reverse this procedure.

## Touchpad

To remove the touchpad, use this procedure and illustration.

**Table 6-3 Touchpad descriptions and part numbers**

Description	Spare part number
Ceramic white, with cable	P23092-001
Shadow black, with cable	P23093-001

Before removing the touchpad, follow these steps:

1. Prepare the computer for disassembly (see [Preparation for disassembly on page 38](#)).
2. Remove the bottom cover (see [Bottom cover on page 38](#)).
3. Remove the battery (see [Battery on page 39](#)).

Remove the touchpad:

1. Remove the four Phillips M2.0 × 3.0 screws **(1)** that secure the touchpad bracket to the computer.
2. Remove the touchpad bracket from the computer **(2)**.

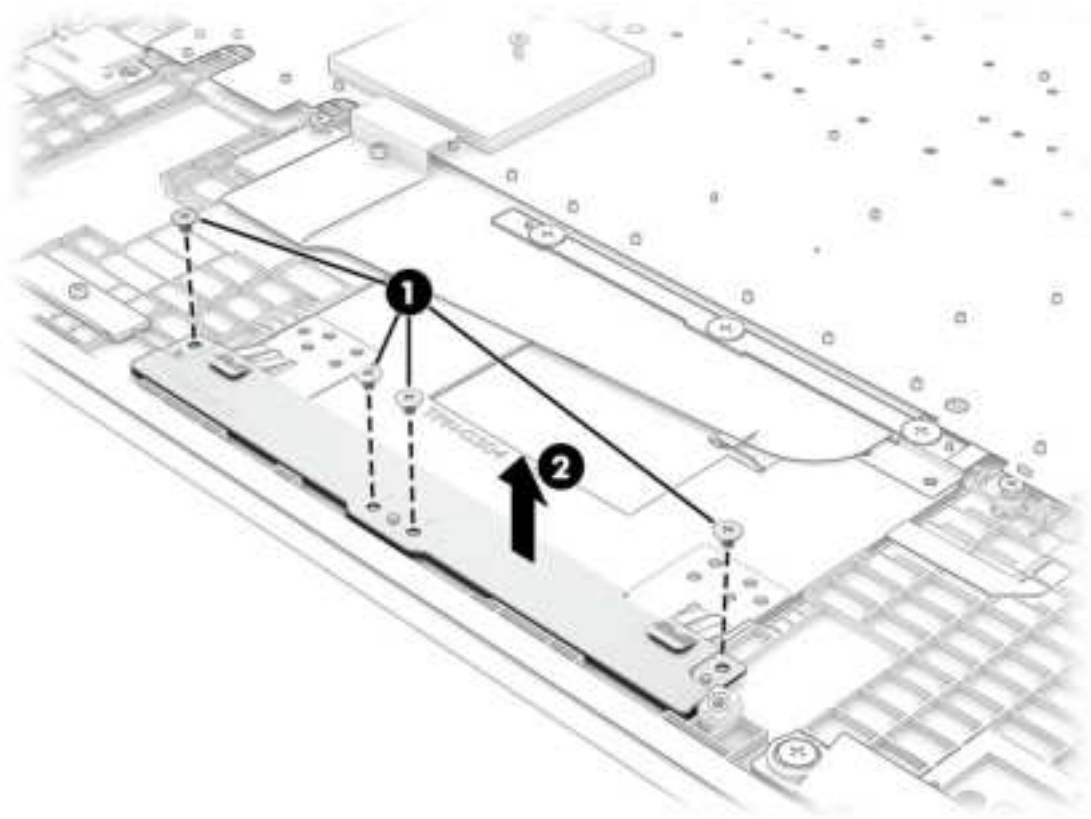

3. Lift but do not remove the Mylar cover **(1)**.
4. Disconnect the cable from the ZIF connector on the touchpad **(2)**.
5. Remove the three Phillips M2.0 × 2.0 screws **(3)** that secure the touchpad to the computer.
6. Lift the tape (not shown) from the touchpad **(4)**.

7. Carefully press up from underneath on the touchpad to release it from the computer (5).
8. Remove the touchpad from the computer (6).

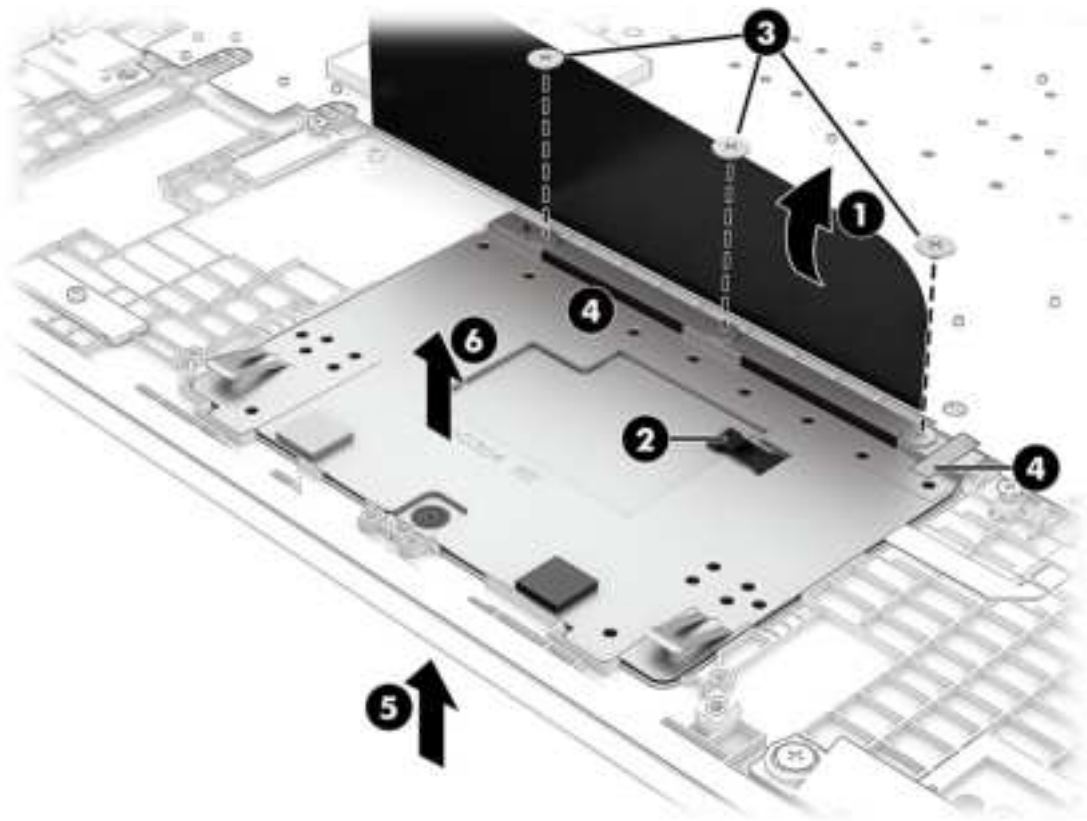

To install the touchpad, reverse this procedure.

## Heat sink

To remove the heat sink, use these procedures and illustrations.

**Table 6-4 Heat sink description and part number**

Description	Spare part number
Heat sink	P23095-001

Before removing the heat sink, follow these steps:

1. Prepare the computer for disassembly (see [Preparation for disassembly on page 38](#)).
2. Remove the bottom cover (see [Bottom cover on page 38](#)).
3. Disconnect the battery from the system board (see [Battery on page 39](#)). Removal of the battery is not required.

Remove the heat sink:

1. In the order of the screws labeled from 1 to 7 on the heat sink, remove the seven Phillips screws (1) that secure the heat sink to the system board.

2. Tilt the heat sink upward from the rear of the computer carefully, without putting pressure on the heat pipe (2).
3. Remove the heat sink from the computer (3).

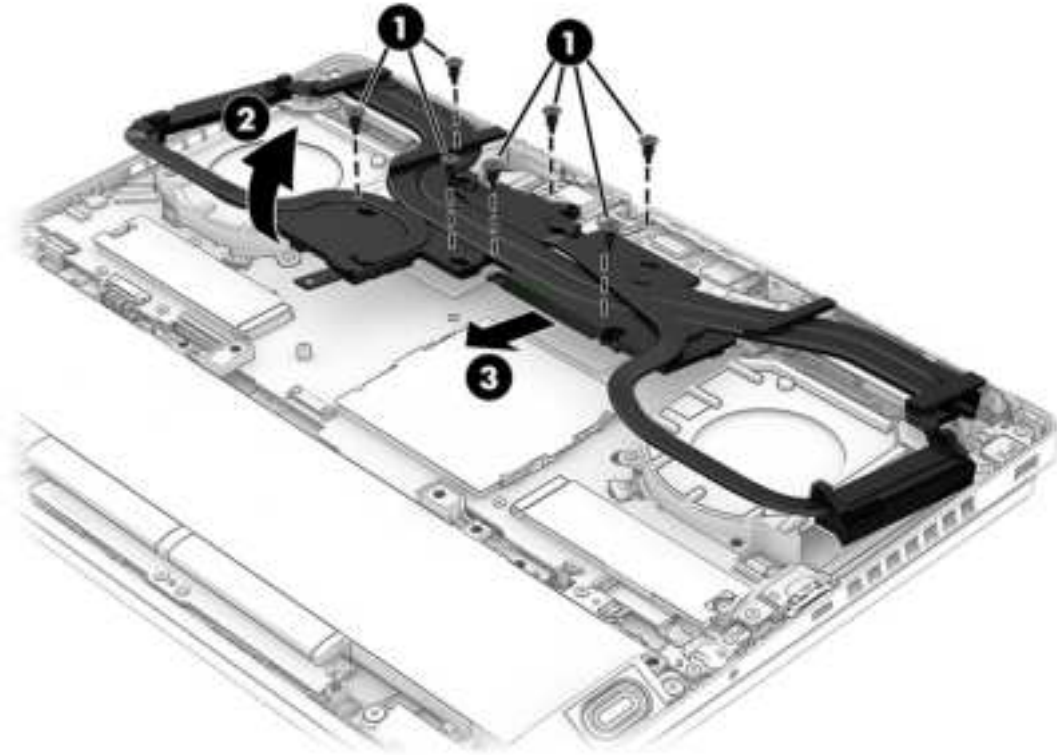

4. Thoroughly clean the thermal material from the surfaces of the heat sink and the system board components each time the heat sink is removed. Replacement thermal material is included with the heat sink and system board spare part kits. The following illustration shows the replacement thermal material locations.

Thermal paste is used on the system board components (1) and on the heat sink areas (2) that service them.

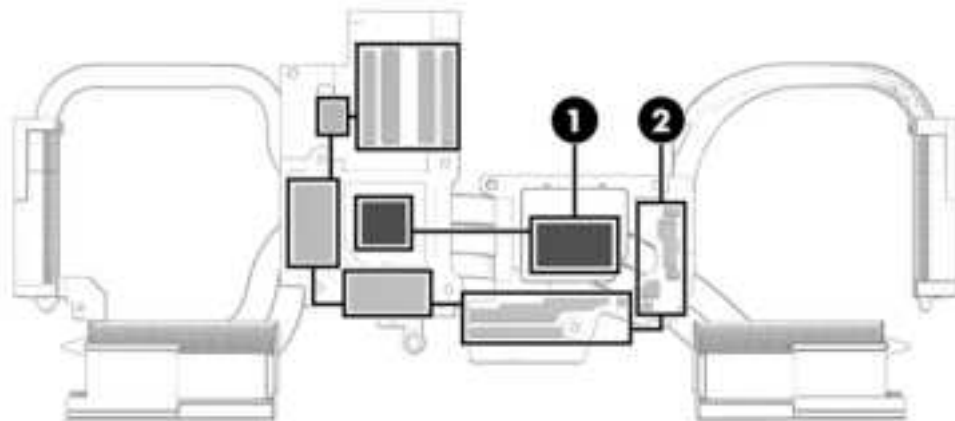

To install the heat sink, reverse this procedure. When installing the heat sink, tighten the screws in the order from 1 to 7.

## Fans

To remove the fans, use this procedure and illustration.

**Table 6-5** Fan description and part number

Description	Spare part number
Fans	P23096-001

Before removing the fans, follow these steps:

1. Prepare the computer for disassembly (see [Preparation for disassembly on page 38](#)).
2. Remove the bottom cover (see [Bottom cover on page 38](#)).
3. Disconnect the battery from the system board (see [Battery on page 39](#)). Removal of the battery is not required.
4. Remove the heat sink (see [Heat sink on page 53](#)).

Remove the fan assembly:

1. Remove the six Phillips M2.0 × 4.0 screws (1) that secure the fans to the computer.
2. Disconnect the fan cables from the system board (2).
3. Remove the fans from the computer (3).

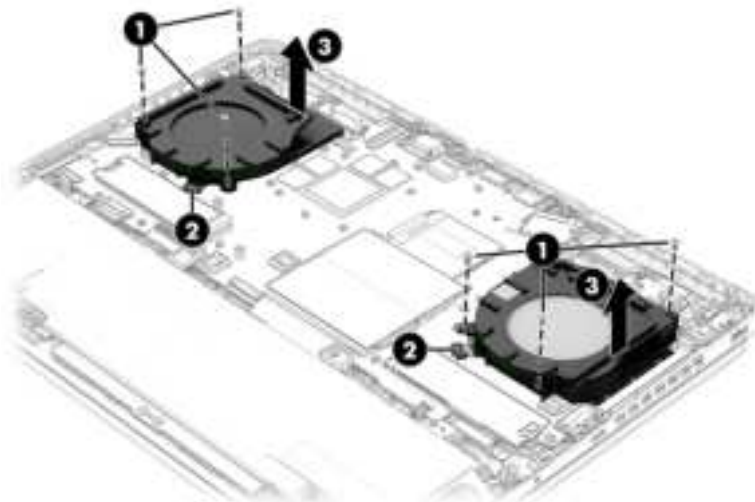

To install the fans, reverse this procedure.

## WLAN module

To remove the WLAN module, use this procedure and illustration.

**Table 6-6 WLAN module descriptions and part numbers**

Description	Spare part number
Realtek 11ax Wi-Fi 6 Bluetooth 5.4 WLAN	P06350-005
Intel® AX211 Wi-Fi 6E Bluetooth 5.3 WLAN	N22541-005

 **IMPORTANT:** To prevent an unresponsive system, replace the wireless module only with a wireless module authorized for use in the computer by the governmental agency that regulates wireless devices in your country or region. If you replace the module and then receive a warning message, remove the module to restore device functionality, and then contact technical support.

Before removing the WLAN module, follow these steps:

1. Prepare the computer for disassembly (see [Preparation for disassembly on page 38](#)).
2. Remove the bottom cover (see [Bottom cover on page 38](#)).
3. Disconnect the battery from the system board (see [Battery on page 39](#)). Removal of the battery is not required.
4. Remove the heat sink (see [Heat sink on page 53](#)).
5. Remove the fans (see [Fans on page 55](#)).

Remove the WLAN module:

1. Remove any transparent covers from WLAN connectors.
2. Remove the Phillips M2.0 × 3.5 screw **(1)**.
3. Remove the WLAN module bracket **(2)**.
4. Carefully disconnect the two antenna cables **(3)** from the module
5. Remove the WLAN module **(4)**.

 **NOTE:** Models have either one or two WLAN antennas. On models with two antennas, the #1 white WLAN antenna cable connects to the WLAN module #1 Main terminal. The #2 black WLAN antenna cable connects to the WLAN module #1 Aux terminal.

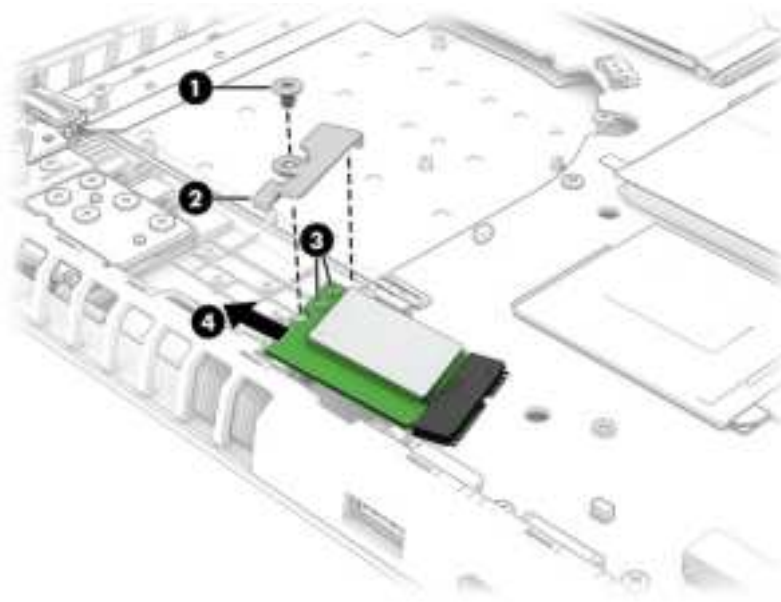

6. If the WLAN antenna is not connected to the terminal on the WLAN module, install a protective sleeve on the antenna connector, as shown in the following illustration.

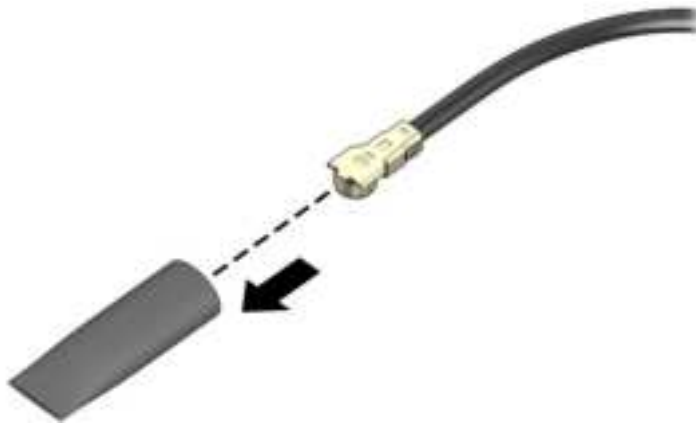

To install the WLAN module, reverse this procedure.

## USB board (left)

To remove the left-side USB board, use this procedure and illustration.

**Table 6-7 Left-side USB board descriptions and part numbers**

Description	Spare part number
USB board (left)	P23399-001
Cable kit	P25411-001

Before removing the left-side USB board, follow these steps:

1. Prepare the computer for disassembly (see [Preparation for disassembly on page 38](#)).

2. Remove the bottom cover (see [Bottom cover on page 38](#)).
3. Disconnect the battery from the system board (see [Battery on page 39](#)). Removal of the battery is not required.
4. Remove the heat sink (see [Heat sink on page 53](#)).
5. Remove the fans (see [Fans on page 55](#)).

Remove the USB board:

1. Disconnect the cable from the USB board ZIF connector (1).
2. Remove the two Phillips M2.0 × 3.0 screws (2) that secure the board to the computer.
3. Remove the board (3) from the computer.
4. Disconnect the cable (4) from the system board ZIF connector.
5. Remove the cable (5) from the computer.

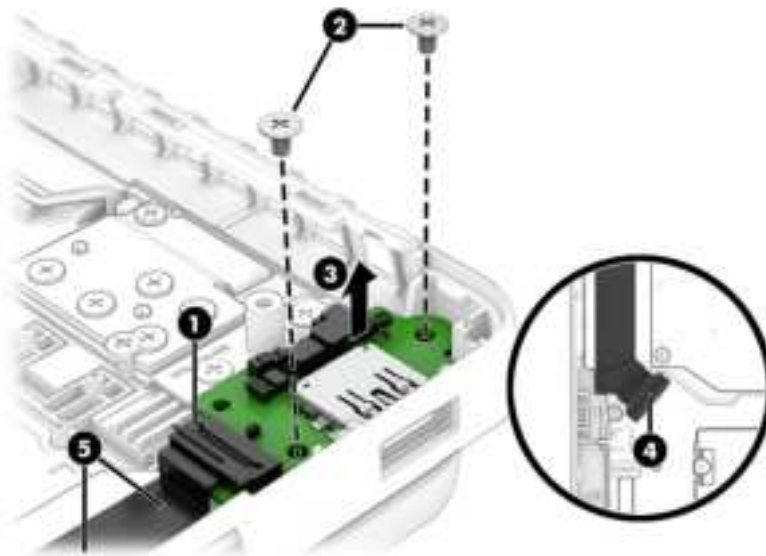

To install the left-side USB board, reverse this procedure.

## USB board (right)

To remove the right-side USB board, use this procedure and illustration.

**Table 6-8 Right-side USB board descriptions and part numbers**

Description	Spare part number
USB board (right)	P23086-001
Cable kit	P25411-001

Before removing the right-side USB board, follow these steps:

1. Prepare the computer for disassembly (see [Preparation for disassembly on page 38](#)).

2. Remove the bottom cover (see [Bottom cover on page 38](#)).
3. Disconnect the battery from the system board (see [Battery on page 39](#)). Removal of the battery is not required.
4. Remove the heat sink (see [Heat sink on page 53](#)).
5. Remove the fans (see [Fans on page 55](#)).

Remove the USB board:

1. Disconnect the cable (1) from the USB board ZIF connector.
2. Remove the two Phillips M2.0 × 3.0 screws (2) that secure the board to the computer.
3. Remove the board (3) from the computer.
4. Disconnect the cable (4) from the system board ZIF connector.
5. Remove the cable (5) from the computer.

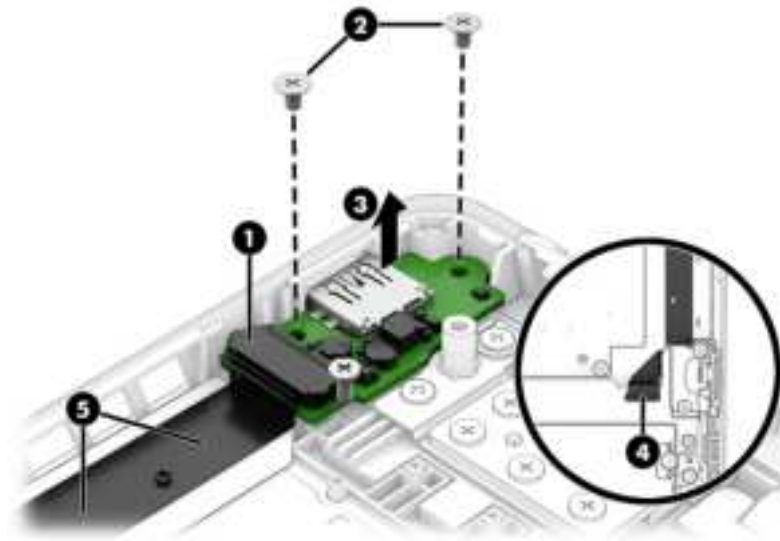

To install the right-side USB board, reverse this procedure.

## System board

To remove the system board, use these procedures and illustrations.

**Table 6-9 System board descriptions and part numbers**

Description	Spare part number
<b>System board</b> (includes processor):	
All system boards use the following part numbers:	
xxxxxx-001: Non-Windows operating system	
xxxxxx-601: Windows 10 operating system	
AMD Ryzen AI 5 340 processor with NVIDIA GeForce RTX 4050 graphics	P24286-xx1

Before removing the system board, follow these steps:

1. Prepare the computer for disassembly (see [Preparation for disassembly on page 38](#)).
2. Remove the bottom cover (see [Bottom cover on page 38](#)).
3. Remove the battery and battery brackets (see [Battery on page 39](#)).
4. Remove the heat sink (see [Heat sink on page 53](#)).
5. Remove the fans (see [Fans on page 55](#)).
6. Remove the WLAN module (see [WLAN module on page 55](#)).

When you replace the system board, be sure to remove the following components (as applicable) from the defective system board and install them on the replacement system board:

- Memory modules (see [Memory modules on page 46](#)).
- WLAN module (see [WLAN module on page 55](#)).
- Heat sink (see [Heat sink on page 53](#)).
- Solid state drive (see [Solid-state drive on page 47](#)).

Remove the system board:

1. Disconnect the following cables from the system board:
  - Infrared board cable **(1)**
  - Display panel cable (ZIF) **(2)**
  - Left USB board cable (ZIF) **(3)**
  - Left speaker cable **(4)**
  - Audio board cable **(5)**
  - Touchpad cable (ZIF) **(6)**
  - Keyboard cable (ZIF) **(7)**
  - Battery cable **(8)**
  - Keyboard backlight cable (ZIF) **(9)**
  - Right speaker cable **(10)**

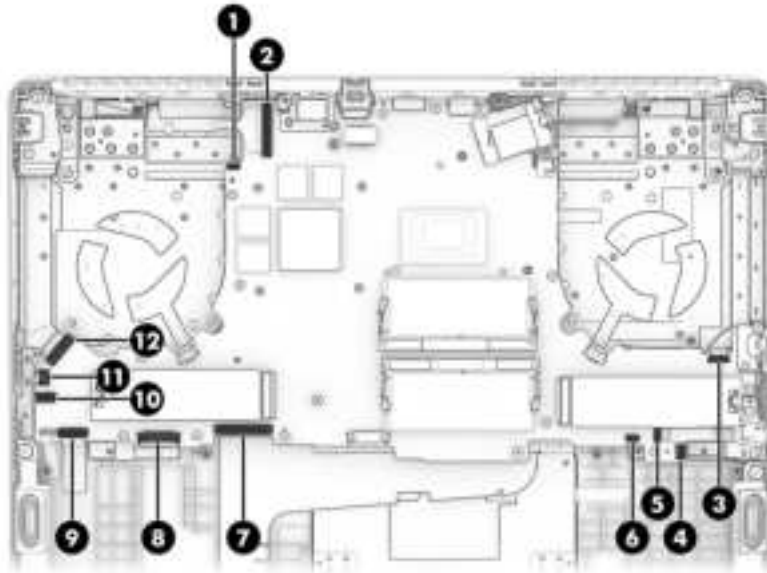

2. Remove the two Phillips screws (1) that secure the power connector bracket to the system board.
3. Remove the power connector bracket (2) from the system board.

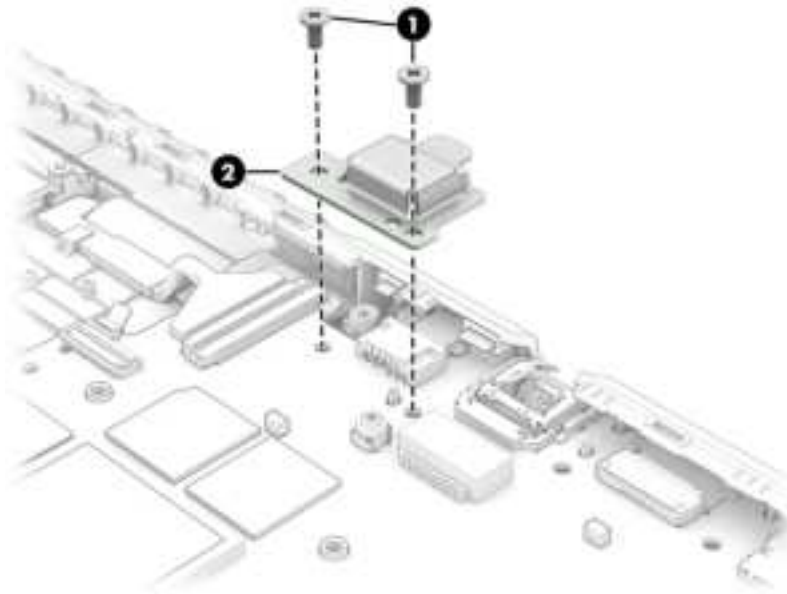

- Remove the 12 Phillips M2.0 × 4.0 screws that secure the system board to the computer.

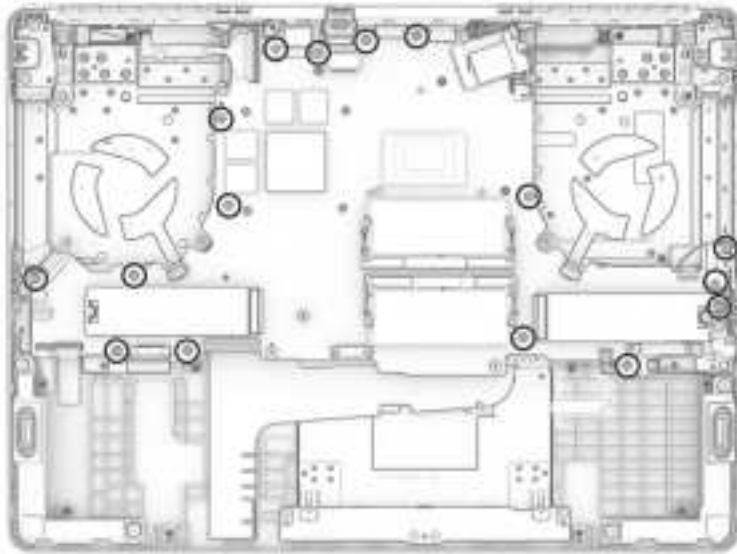

- Tilt the system board up at the front (1) and then remove the system board (2) from the computer.

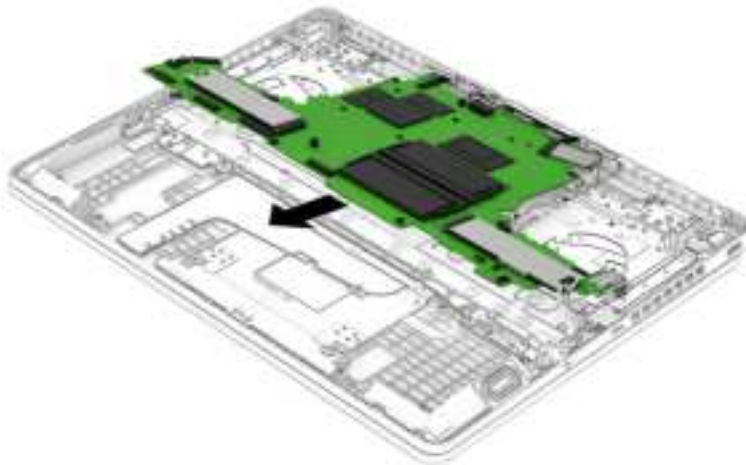

To install the system board, reverse this procedure.

## Infrared board

To remove the infrared board, use this procedure and illustration.

 **NOTE:** The infrared board spare part kit includes the infrared board cable.

**Table 6-10** Infrared board description and part number

Description	Spare part number
Infrared board (includes infrared board cable)	P23084-001

Before removing the infrared board, follow these steps:

1. Prepare the computer for disassembly (see [Preparation for disassembly on page 38](#)).
2. Remove the bottom cover (see [Bottom cover on page 38](#)).
3. Remove the battery (see [Battery on page 39](#)).
4. Remove the heat sink (see [Heat sink on page 53](#)).
5. Remove the fans (see [Fans on page 55](#)).
6. Remove the system board (see [System board on page 59](#)).

Remove the infrared board:

1. Remove the two Phillips screws M2.0 x M3.0 (1) securing the board to the top cover.
2. Remove the infrared board (2).

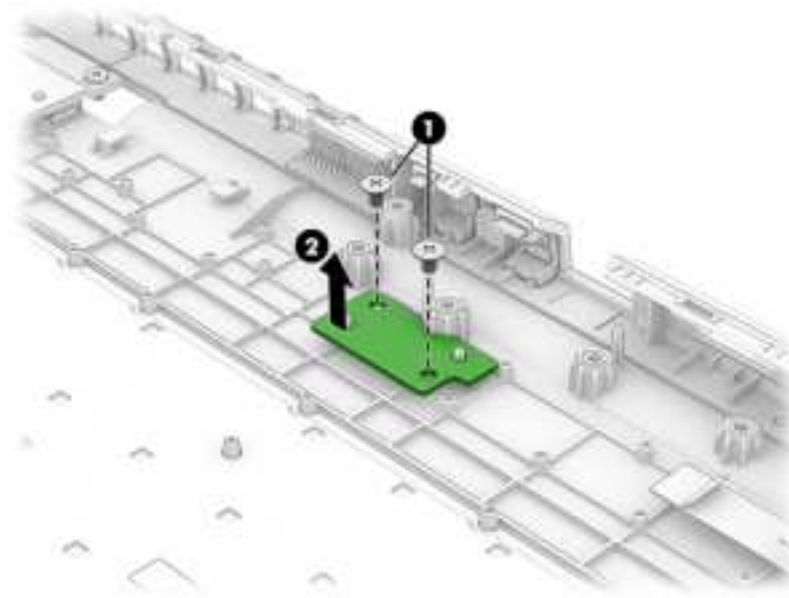

To install the infrared board, reverse this procedure.

## Display assembly

To remove and disassemble the display assembly, use these procedures and illustrations.

Full hinge-up displays are not available as spare parts. Spare parts for displays are available only at the subcomponent level.

Before removing the display panel, follow these steps:

1. Prepare the computer for disassembly (see [Preparation for disassembly on page 38](#)).
2. Remove the bottom cover (see [Bottom cover on page 38](#)).
3. Disconnect the battery from the system board (see [Battery on page 39](#)). Removal of the battery is not required.

Remove the display bezel:

1. You can remove the bezel with the display assembly connected to the computer. To remove the bezel:
  - a. Open the display (1) to the maximum angle and position the display assembly on a flat surface.
  - b. Using a nonmarking pry tool, release the bezel (2) from the display assembly and remove the bezel.

---

 **NOTE:** To avoid damaging the panel, do not use a tool to release the inside of the bezel. You can use a tool only when you insert it from the **outside** of the top, left, and right sides of the bezel. Use your fingers to lift up on the bezel. Avoid pressing down on the panel during removal.

---

The bezel is available as spare part number P23114-001 (ceramic white) or P23115-001 (shadow black).



2. You can remove the display panel with the display assembly connected to the computer. To remove the display panel:
  - a. The display panel is secured to the display enclosure with tape that is installed under the left and right sides of the panel. To remove the panel, use tweezers to grasp the ends of the tape (1). While turning the tweezers, wrap the tape around the tweezers (2) as you continue to pull the tape out from behind the display panel (3). You must pull the tape multiple times before it is completely removed.

---

 **IMPORTANT:** Pull the tape out slowly and evenly to prevent it from breaking prematurely.

---

- b. Lift but do not remove the Mylar cover (4).
- c. Lift the display cable retention clip (5).
- d. Release the display cable from the display cable connector (6).
- e. Lift and remove the display panel (7).

Display panels are available as the following spare part numbers:

P23077-001: UWVA, 500 nits, 250 Hz

P23078-001: UWVA, 400 nits, 165 Hz

P23076-001: UWVA, 300 nits, 144 Hz



3. The remaining display components require that you remove the display assembly from the computer. To remove the display assembly:
  - a. Remove the heat sink (see [Heat sink on page 53](#)).
  - b. Remove the fans (see [Fans on page 55](#)).
  - c. Remove the WLAN module (see [WLAN module on page 55](#)).
  - d. Remove the system board (see [System board on page 59](#)).
  - e. Close the computer (1).
  - f. Remove the 10 hinge screws (2) from the hinges.
  - g. Open the computer (3).

- h. Remove the top cover (4).

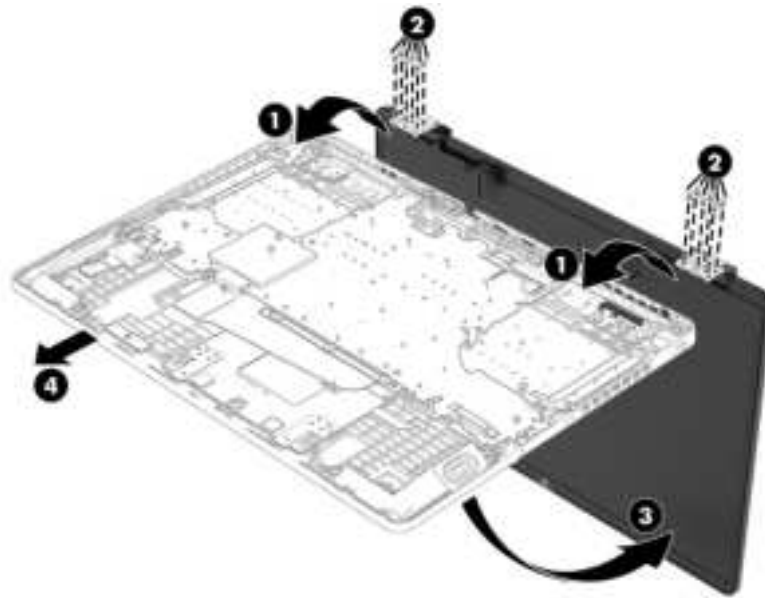

- 4. Remove the hinge caps.
  - a. Rotate the hinges (1) to the closed position.
  - b. Remove the hinge caps (2).

Hinge caps are available as a set as spare part numbers P23120-001 (ceramic white) and P23121-001 (shadow black).

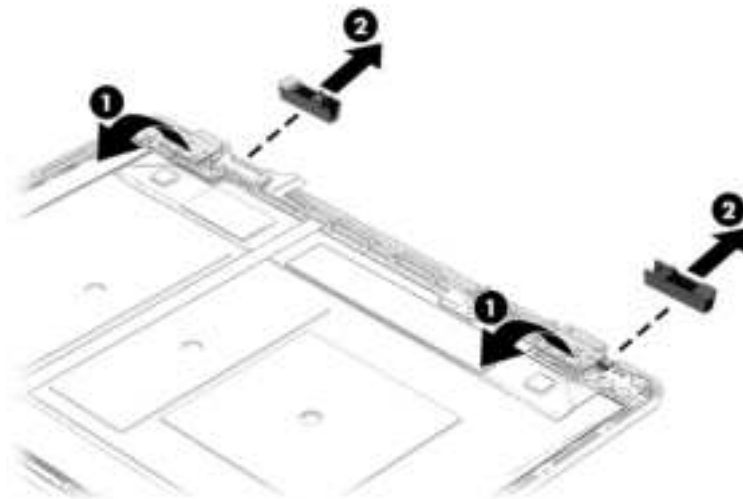

- 5. Remove the hinges and WLAN antennas from the display assembly.
  - a. Rotate the hinges to the open position (1).
  - b. Remove the two Phillips M2.5 × 4.5 screws (2) and the eight broad head Phillips M2.0 × 2.5 screws (2) from the hinge subassembly.

- c. Remove the hinge subassembly (3) from the display assembly.  
Hinges are available as a set as spare part number P23119-001.

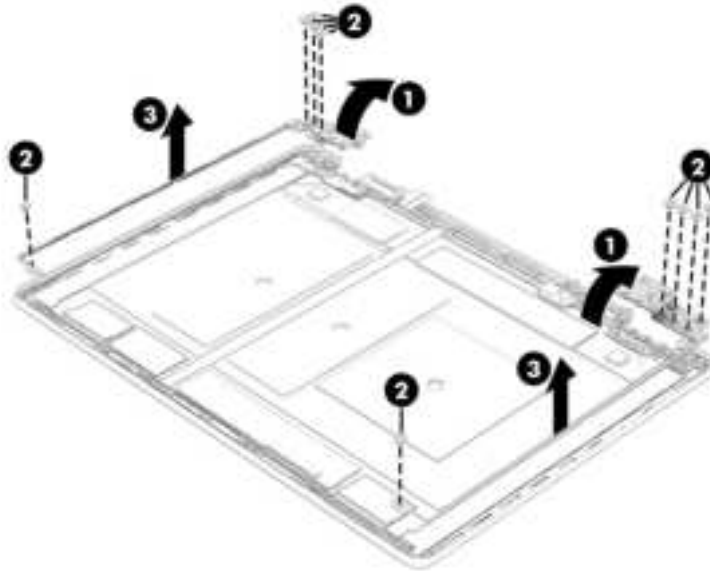

6. To remove the camera module:

- a. Using a pry tool, carefully release the display assembly top bracket from the retention clips.

 **IMPORTANT:** The top bracket is thin and might bend if not removed with care.

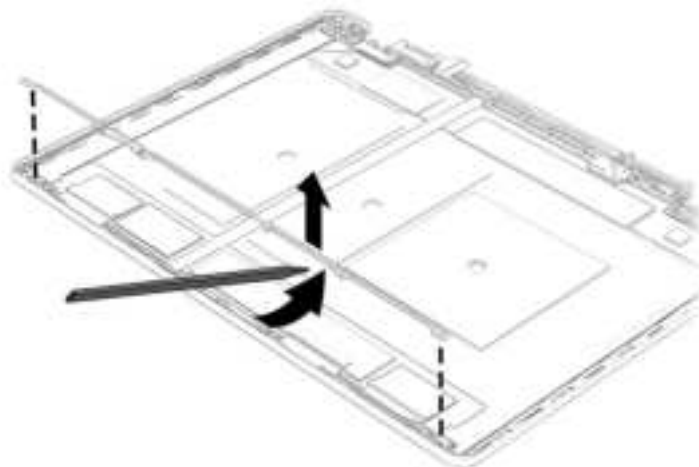

- b. Use a pry tool (1) to loosen the camera module from the display back cover .
- c. Lift up evenly across the module and peel the module up from the display back cover, and then disconnect the cable (2) from the reverse ZIF connector on the module.

- d. Remove the camera module **(3)** from the display assembly. The camera module is available as spare part number P23117-001.

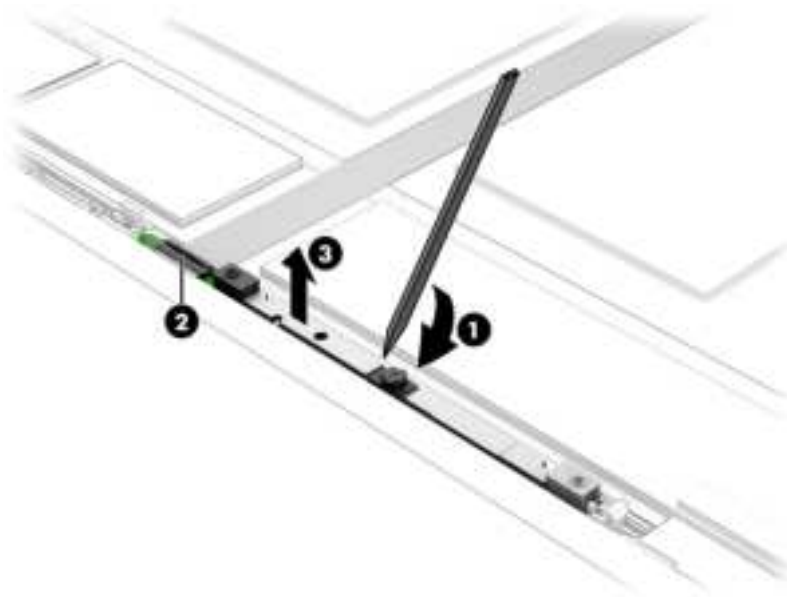

- 7. To remove the display/camera cable, peel the cable off the inside of the display back cover, remove the cable from the clips at the bottom of the display back cover, and then remove the cable.

Display panel and camera module cables are available as spare part number P23118-001.

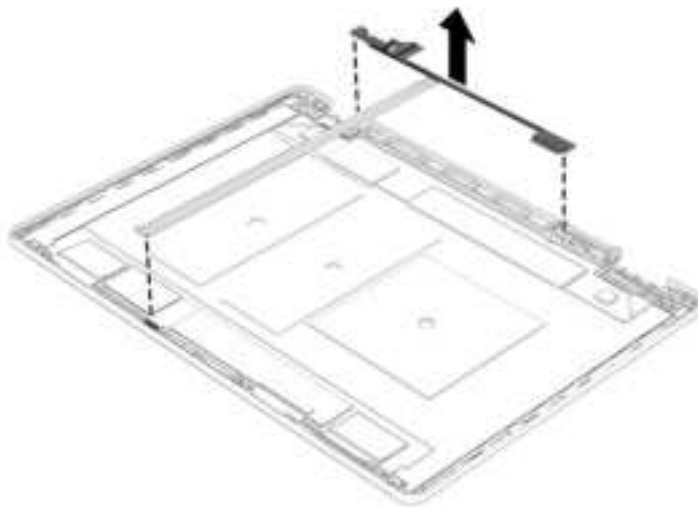

- 8. To remove the antenna cables, remove the cables from the clips at the bottom and sides **(1)** of the display assembly, peel the antennas off the inside **(2)** of the display back cover, and then remove the antennas and cables.

Antenna cables are available as spare part number P25411-001.

Display back covers are available as spare part number P23108-001 for ceramic white and P23110-001 for shadow black.

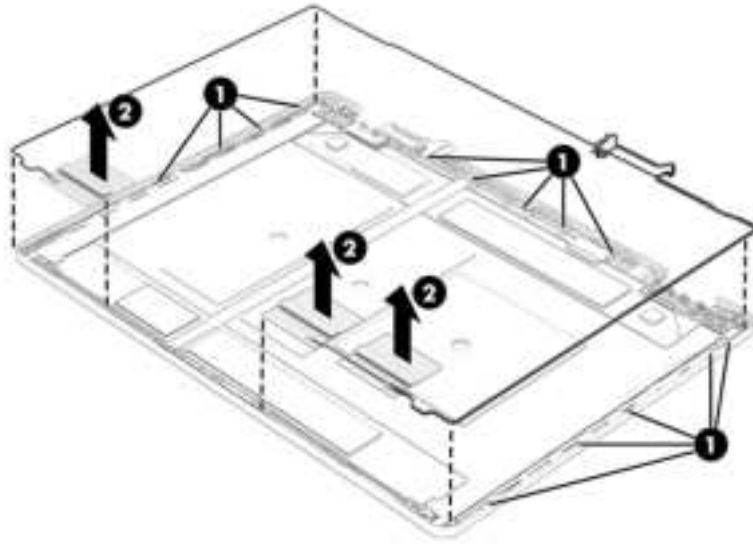

To reassemble and replace the display assembly, reverse this procedure.

## Keyboard with top cover

The top cover with keyboard remains after removing all other spare parts from the computer. In this section, the first table provides the main spare part numbers for the top cover with keyboards. The second table provides the country codes.

**Table 6-11 Keyboard with top cover descriptions and part numbers**

Description	Spare part number
Ceramic white, 4-zone RGB backlight	P23880-xxx
Ceramic white, backlight	P23879-xxx
Shadow black, 4-zone RGB backlight	P23882-xxx
Shadow black, backlight	P23881-xxx

**Table 6-12 Spare part country codes**

For use in country or region	Spare part number	For use in country or region	Spare part number	For use in country or region	Spare part number
Belgium	-A41	Iceland	-DD1	Saudi Arabia	-171
Brazil	-201	India	-D61	Slovenia	-BA1
Bulgaria	-261	Israel	-BB1	South Korea	-AD1
Chile	-161	Italy	-061	Spain	-071
Czech Republic/Slovakia	-FL1	Japan	-291	Switzerland	-BG1
Denmark, Finland, and Norway	-DH1	Kazakhstan	-DF1	Taiwan	-AB1
French Canada	-DB1	The Netherlands	-B31	Thailand	-281

**Table 6-12 Spare part country codes (continued)**

<b>For use in country or region</b>	<b>Spare part number</b>	<b>For use in country or region</b>	<b>Spare part number</b>	<b>For use in country or region</b>	<b>Spare part number</b>
France	-051	Northern Africa	-FP1	Turkey	-141
Germany	-041	Portugal	-131	Ukraine	-BD1
Greece	-151	Romania	-271	United Kingdom	-031
Hungary	-211	Russia	-251	United States	-001

---

# 7 Using Setup Utility (BIOS)

Setup Utility, or Basic Input/Output System (BIOS), controls communication between all the input and output devices on the system (such as disk drives, display, keyboard, mouse, and printer). Setup Utility (BIOS) includes settings for the types of devices installed, the startup sequence of the computer, and the amount of system and extended memory.

---

 **NOTE:** To start Setup Utility on convertible computers, your computer must be in notebook mode and you must use the keyboard attached to your notebook.

---

## Starting Setup Utility (BIOS)

You have several ways to access the Setup Utility (BIOS).

---

 **IMPORTANT:** Use extreme care when making changes in Setup Utility (BIOS). Errors can prevent the computer from operating properly.

---

Use one of these options:

- Turn on or restart the computer and quickly press **f10**.
- Turn on or restart the computer, quickly press **esc**, and then press **f10** when the Start menu is displayed.

# Updating Setup Utility (BIOS)

Updated versions of Setup Utility (BIOS) might be available on the HP website. Most BIOS updates on the HP website are packaged in compressed files called *SoftPaqs*. Some download packages contain a file named `Readme.txt`, which contains information regarding installing and troubleshooting the file.

## Determining the BIOS version

To decide whether you need to update Setup Utility (BIOS), first determine the BIOS version on your computer.

To reveal the BIOS version information (also known as *ROM date* and *System BIOS*), use one of these options.

- HP Support Assistant
  1. Perform one of these tasks:
    - Select the **Search** icon in the taskbar, type `support` in the search box, and then select the **HP Support Assistant** app.
    - Select the question mark icon in the taskbar.
  2. Under **My notebook**, select **Specifications**.
- Setup Utility (BIOS)
  1. Start Setup Utility (BIOS) (see [Starting Setup Utility \(BIOS\) on page 71](#)).
  2. Select **Main**, and then make note of the BIOS version.
  3. Select **Exit**, select one of the options, and then follow the on-screen instructions.
- In Windows, press `ctrl+alt+s`.

To check for later BIOS versions, see [Preparing for a BIOS update on page 72](#).

## Preparing for a BIOS update

Be sure to follow all prerequisites before downloading and installing a BIOS update.

---

 **IMPORTANT:** To reduce the risk of damage to the computer or an unsuccessful installation, download and install a BIOS update only when the computer is connected to reliable external power using the HP AC adapter provided with the computer (select products only), a replacement AC adapter provided by HP, or an AC adapter with the power rating specified on the product label. Do not download or install a BIOS update while the computer is running on battery power, docked in an optional docking device, or connected to an optional power source. During the download and installation, follow these instructions:

- Do not disconnect power from the computer by unplugging the power cord from the AC outlet.
- Do not shut down the computer or initiate Sleep.
- Do not insert, remove, connect, or disconnect any device, cable, or cord.

 **NOTE:** If your computer is connected to a network, consult the network administrator before installing any software updates, especially system BIOS updates.

---

## Downloading a BIOS update

After you review the prerequisites, you can check for and download BIOS updates.

1. Perform one of these tasks:
  - Select the **Search** icon in the taskbar, type `support` in the search box, and then select the **HP Support Assistant** app.
  - Select the question mark icon in the taskbar.
2. Select **Updates**. The **Checking for Updates** window opens, and Windows checks for updates.
3. Follow the on-screen instructions.
4. At the download area, follow these steps:
  - a. Identify the most recent BIOS update and compare it to the BIOS version currently installed on your computer. If the update is more recent than your BIOS version, make a note of the date, name, or other identifier. You might need this information to locate the update later, after it has been downloaded to your hard drive.
  - b. Follow the on-screen instructions to download your selection to the hard drive.

Make a note of the path to the location on your hard drive where the BIOS update is downloaded. You will need to access this path when you are ready to install the update.

## Installing a BIOS update

BIOS installation procedures vary. Follow any instructions that appear on the screen after the download is complete. If no instructions appear, follow these steps.

1. Select the **Search** icon in the taskbar, type `file` in the search box, and then select **File Explorer**.
2. Select your hard drive designation. The hard drive designation is typically Local Disk (C:).
3. Using the hard drive path you recorded earlier, open the folder that contains the update.
4. Double-click the file that has an `.exe` extension (for example, `filename.exe`).  
The BIOS installation begins.
5. Complete the installation by following the on-screen instructions.

---



 **NOTE:** After a message on the screen reports a successful installation, you can delete the downloaded file from your hard drive.

---

---

## 8 Backing up, restoring, and recovering

You can use Windows tools or HP software to back up your information, create a restore point, reset your computer, create recovery media, or restore your computer to its factory state. Performing these standard procedures can return your computer to a working state faster.

- 
-  **IMPORTANT:** If you are performing recovery procedures on a tablet, the tablet battery must be at least 70% charged before you start the recovery process.
  -  **IMPORTANT:** For a tablet with a detachable keyboard, connect the tablet to the keyboard base before beginning any recovery process.
-

# Backing up information and creating recovery media

These methods of creating recovery media and backups are available on select products only.

## Using Windows tools for backing up

HP recommends that you back up your information immediately after initial setup. You can do this task either using Windows Backup locally with an external USB flash drive or using online tools.

---

 **NOTE:** If computer storage is 32 GB or less, Microsoft System Restore is disabled by default.

---

## Using the HP Cloud Recovery Download Tool to create a recovery USB flash drive (select products only)

You can use the HP Cloud Recovery Download Tool to create an HP Recovery bootable USB flash drive.

For details:

- Go to <http://www.hp.com>, search for HP Cloud Recovery, and then select the result that matches the type of computer that you have and follow the on-screen instructions.

---

 **NOTE:** In select countries, if you cannot create the HP Recovery USB flash drive yourself, contact support. Go to <http://www.hp.com/support>, select your country or region, and then follow the on-screen instructions.

 **IMPORTANT:** HP recommends that you follow the [Restoring and recovery methods on page 76](#) to restore your computer before you obtain and use the HP USB flash drive. Using a recent backup can return your machine to a working state sooner than using the HP USB flash drive. After the system is restored, reinstalling all the operating system software released since your initial purchase can be a lengthy process.

---

# Restoring and recovering your system

You have several tools available to recover your system both within and outside of Windows if the desktop cannot load.

HP recommends that you attempt to restore your system using the [Restoring and recovery methods on page 76](#).

## Creating a system restore

System Restore is available in Windows. The System Restore software can automatically or manually create restore points, or snapshots, of the system files and settings on the computer at a particular point.

When you use System Restore, it returns your computer to its state at the time you made the restore point. Your personal files and documents should not be affected.

## Restoring and recovery methods

After you run the first method, test to see whether the issue still exists before you proceed to the next method, which might now be unnecessary.

1. Run a Microsoft System Restore.
2. Run Reset this PC.



---

**NOTE:** The options **Remove everything** and then **Fully clean the drive** can take several hours to complete and leave no information on your computer. It is the safest way to reset your computer before you recycle it.

---

3. Recover using the HP Recovery USB flash drive. For more information, see [Recovering using the HP Recovery USB flash drive on page 76](#).

For more information about the first two methods, see the Get Help app:

- Select the **Start** button, select **All apps**, select the **Get Help** app, and then enter the task you want to perform.



---

**NOTE:** You must be connected to the internet to access the Get Help app.

---

## Recovering using the HP Recovery USB flash drive

You can use the HP Recovery USB flash drive to recover the operating system and drivers that were installed at the factory. On select products, you can create recovery media on a bootable USB flash drive using the HP Cloud Recovery Download Tool.

For details, see [Using the HP Cloud Recovery Download Tool to create a recovery USB flash drive \(select products only\) on page 75](#).



---

**NOTE:** In select countries, if you cannot create the HP Recovery USB flash drive yourself, contact support. Go to <http://www.hp.com/support>, select your country or region, and then follow the on-screen instructions.

---

To recover your system:

- Insert the HP Recovery USB flash drive, and then restart the computer.

 **NOTE:** HP recommends that you follow the [Restoring and recovery methods on page 76](#) to restore your computer before you obtain and use the HP USB flash drive. Using a recent backup can return your machine to a working state sooner than using the HP USB flash drive. After the system is restored, reinstalling all the operating system software released since your initial purchase can be a lengthy process.

---

## Changing the computer boot order

If your computer does not restart using the HP Recovery USB flash drive, you can change the computer boot order, which is the order of devices listed in BIOS for startup information.

 **IMPORTANT:** For a tablet with a detachable keyboard, connect the tablet to the keyboard base before beginning these steps.

---

To change the boot order:

1. Insert the HP Recovery USB flash drive.
2. Access the system **Startup** menu.
  - For computers or tablets with keyboards attached, turn on or restart the computer or tablet, quickly press **esc**, and then press **f9** for boot options.
  - For tablets without keyboards, turn on or restart the tablet, and then quickly press and hold one of the following buttons:
    - Volume up
    - Volume down

Then select **f9**.
3. Select the USB flash drive to boot from, and then follow the on-screen instructions.

## Using HP Sure Recover (select products only)

Select computer models are configured with HP Sure Recover, a PC operating system (OS) recovery solution built into the hardware and software. HP Sure Recover can fully restore the HP OS image without installed recovery software.

Using HP Sure Recover, an administrator or user can restore the system and install:

- Latest version of the operating system
- Platform-specific device drivers
- Software applications, in the case of a custom image

To access the latest documentation for HP Sure Recover, go to <http://www.hp.com/support>. Follow the on-screen instructions to find your product and locate your documentation.

---

## 9 Using HP PC Hardware Diagnostics

You can use the HP PC Hardware Diagnostics utility to determine whether your computer hardware is running properly. The three versions are HP PC Hardware Diagnostics Windows, HP PC Hardware Diagnostics UEFI (Unified Extensible Firmware Interface), and (for select products only) Remote HP PC Hardware Diagnostics UEFI, a firmware feature.

## Using HP PC Hardware Diagnostics Windows (select products only)

HP PC Hardware Diagnostics Windows is a Windows-based utility that allows you to run diagnostic tests to determine whether the computer hardware is functioning properly. The tool runs within the Windows operating system to diagnose hardware failures.

If HP PC Hardware Diagnostics Windows is not installed on your computer, you must download and install it. To download HP PC Hardware Diagnostics Windows, see [Downloading HP PC Hardware Diagnostics Windows on page 80](#).

### Using an HP PC Hardware Diagnostics Windows hardware failure ID code

When HP PC Hardware Diagnostics Windows detects a failure that requires hardware replacement, a 24-digit failure ID code is generated for select component tests. For interactive tests, such as keyboard, mouse, or audio and video palette, you must perform troubleshooting steps before you can receive a failure ID.

You have several options after you receive a failure ID:

- Select **Next** to open the Event Automation Service (EAS) page, where you can log the case.
- Scan the QR code with your mobile device, which takes you to the EAS page, where you can log the case.
- Select the box next to the 24-digit failure ID to copy your failure code and send it to support.

### Accessing HP PC Hardware Diagnostics Windows

After HP PC Hardware Diagnostics Windows is installed, you can access it from HP Support Assistant or the Start menu.

#### Accessing HP PC Hardware Diagnostics Windows from HP Support Assistant

After HP PC Hardware Diagnostics Windows is installed, follow these steps to access it from HP Support Assistant:

1. Complete one of the following tasks:
  - Select the **Search** icon in the taskbar, type `support` in the search box, and then select the **HP Support Assistant** app.
  - Select the question mark icon in the taskbar.
2. Select **Fixes & Diagnostics**.
3. Select **Run hardware diagnostics**, and then select **Launch**.
4. When the tool opens, select the type of diagnostic test that you want to run, and then follow the on-screen instructions.

---

 **NOTE:** To stop a diagnostic test, select **Cancel**.

---

#### Accessing HP PC Hardware Diagnostics Windows from the Start menu (select products only)

After HP PC Hardware Diagnostics Windows is installed, follow these steps to access it from the Start menu:

1. Select the **Start** button, and then select **All apps**.
2. Select **HP PC Hardware Diagnostics Windows**.
3. When the tool opens, select the type of diagnostic test that you want to run, and then follow the on-screen instructions.

---

 **NOTE:** To stop a diagnostic test, select **Cancel**.

---

## Downloading HP PC Hardware Diagnostics Windows

The HP PC Hardware Diagnostics Windows downloading instructions are provided in English only. You must use a Windows computer to download this tool because only .exe files are provided.

### Downloading the latest HP PC Hardware Diagnostics Windows version from HP

To download HP PC Hardware Diagnostics Windows from HP, follow these steps:

1. Go to <http://www.hp.com/go/techcenter/pcdiags>. The HP PC Diagnostics home page is displayed.
2. Select **Diagnose PC Hardware issues in Windows**, scroll down to the expanded window that appears, and then select **Download**.
3. A pop-up that asks what you want to do with the file opens. Select **Open** or **Save As**. The latest version of the diagnostics tool opens or downloads to the selected location.

### Downloading the HP PC Hardware Diagnostics Windows from the Microsoft Store

You can download the HP PC Hardware Diagnostics Windows from the Microsoft Store:

1. Select the Microsoft Store app on your desktop or select the **Search** icon in the taskbar, and then type `Microsoft Store` in the search box.
2. Type `HP PC Hardware Diagnostics Windows` in the **Microsoft Store** search box.
3. Follow the on-screen directions.

The tool downloads to the selected location.

### Downloading HP Hardware Diagnostics Windows by product name or number (select products only)

You can download HP PC Hardware Diagnostics Windows by product name or number.

---

 **NOTE:** For some products, you might have to download the software to a USB flash drive by using the product name or number.

---

1. Go to <http://www.hp.com/support>.
2. Select **Software and Drivers**, select your type of product, and then enter the product name or number in the search box that is displayed.
3. In the **Diagnostics** section, select **Download**, and then follow the on-screen instructions to select the specific Windows diagnostics version to be downloaded to your computer or USB flash drive.

The tool downloads to the selected location.

## Installing HP PC Hardware Diagnostics Windows

To install HP PC Hardware Diagnostics Windows, navigate to the folder on your computer or the USB flash drive where the .exe file downloaded, double-click the .exe file, and then follow the on-screen instructions.

## Using HP PC Hardware Diagnostics UEFI

HP PC Hardware Diagnostics Unified Extensible Firmware Interface (UEFI) allows you to run diagnostic tests to determine whether the computer hardware is functioning properly. The tool runs outside the operating system so that it can isolate hardware failures from issues that are caused by the operating system or other software components.

---

 **NOTE:** For some products, you must use a Windows computer and a USB flash drive to download and create the HP UEFI support environment because only .exe files are provided. For more information, see [Downloading HP PC Hardware Diagnostics UEFI to a USB flash drive on page 83](#).

---

If your PC does not start in Windows, you can use HP PC Hardware Diagnostics UEFI to diagnose hardware issues.

### Using an HP PC Hardware Diagnostics UEFI hardware failure ID code

When HP PC Hardware Diagnostics UEFI detects a failure that requires hardware replacement, a 24-digit failure ID code is generated.

For assistance in solving the problem, complete one of these tasks:

- Select **Contact HP**, accept the HP privacy disclaimer, and then use a mobile device to scan the failure ID code that appears on the next screen. The HP Customer Support - Service Center page appears with your failure ID and product number automatically filled in. Follow the on-screen instructions.
- Contact support, and provide the failure ID code.

### Starting HP PC Hardware Diagnostics UEFI

To start HP PC Hardware Diagnostics UEFI, follow this procedure.

1. Turn on or restart the computer, and quickly press **esc**.
2. Press **f2**.

The BIOS searches three places for the diagnostic tools, in the following order:

- a. Connected USB flash drive

---

 **NOTE:** To download the HP PC Hardware Diagnostics UEFI tool to a USB flash drive, see [Downloading the latest HP PC Hardware Diagnostics UEFI version on page 83](#).

---

- b. Hard drive
- c. BIOS

3. When the diagnostic tool opens, select the type of diagnostic test that you want to run, and then follow the on-screen instructions.

## Starting HP PC Hardware Diagnostics UEFI through HP Hotkey Support software (select products only)

This section describes how to start HP PC Hardware Diagnostics UEFI through HP Hotkey Support software.

---

 **NOTE:** You must disable fast boot to access HP PC Hardware Diagnostics UEFI from the HP System Information application.

To disable fast boot:

1. Turn on or restart the computer, and when the HP logo appears, press **f10** to enter Computer Setup.
2. Select **Advanced**, and then select **Boot Options**.
3. Clear **Fast Boot**.
4. Select **Save Changes and Exit**, and then select **Yes**.

---

To start HP PC Hardware Diagnostics UEFI through HP Hotkey Support software, follow this procedure:

1. From the **Start** menu, open the HP System Information Application or press **fn+esc**.
2. In HP System Information screen, select **Run System Diagnostics**, select **Yes** to run the application, and then select **Restart**.

---

 **IMPORTANT:** To prevent loss of data, save your work in all open apps before restarting your computer.

 **NOTE:** When the restart is complete, the computer opens the HP PC Hardware Diagnostics UEFI Application. Proceed with the troubleshooting tests.

---

## Downloading HP PC Hardware Diagnostics UEFI to a USB flash drive

Downloading HP PC Hardware Diagnostics UEFI to a USB flash drive can be useful in some situations.

- HP PC Hardware Diagnostics UEFI is not included in the preinstallation image.
- HP PC Hardware Diagnostics UEFI is not included in the HP Tool partition.
- The hard drive is damaged.

---

 **NOTE:** The HP PC Hardware Diagnostics UEFI downloading instructions are provided in English only, and you must use a Windows computer to download and create the HP UEFI support environment because only `.exe` files are provided.

---

## Downloading the latest HP PC Hardware Diagnostics UEFI version

To download the latest HP PC Hardware Diagnostics UEFI version to a USB flash drive, follow these steps:

1. Go to <http://www.hp.com/go/techcenter/pcdiags>. The HP PC Diagnostics home page is displayed.
2. Select **Diagnose PC Hardware Issues outside of the OS**, scroll down to the expanded window that appears, and then select **Download**.
3. A pop-up that asks what you want to do with the file opens. Select **Open** or **Save As**. The latest version of the diagnostics tool opens or downloads to the selected location.

## Downloading HP PC Hardware Diagnostics UEFI by product name or number (select products only)

You can download HP PC Hardware Diagnostics UEFI by product name or number (select products only) to a USB flash drive.

---

 **NOTE:** For some products, you might have to download the software to a USB flash drive by using the product name or number.

---

1. Go to <http://www.hp.com/support>.
2. Enter the product name or number, select your computer, and then select your operating system.
3. In the **Diagnostics** section, follow the on-screen instructions to select and download the specific UEFI Diagnostics version for your computer.

# Using Remote HP PC Hardware Diagnostics UEFI settings (select products only)

Remote HP PC Hardware Diagnostics UEFI is a firmware (BIOS) feature that downloads HP PC Hardware Diagnostics UEFI to your computer. It can then run the diagnostics on your computer, and it might upload results to a preconfigured server.

For more information about Remote HP PC Hardware Diagnostics UEFI, go to <http://www.hp.com/go/techcenter/pcdiags>, select **Diagnose Other Potential Issues**, scroll down to **Remote PC Hardware Diagnostics UEFI**, and then select **Learn More**.

## Downloading Remote HP PC Hardware Diagnostics UEFI

Remote HP PC Hardware Diagnostics UEFI is also available as a SoftPaq that you can download to a server.

## Downloading the latest Remote HP PC Hardware Diagnostics UEFI version

You can download the latest Remote HP PC Hardware Diagnostics UEFI version to a USB flash drive.

1. Go to <http://www.hp.com/go/techcenter/pcdiags>. The HP PC Diagnostics home page is displayed.
2. Select **Diagnose PC Hardware Issues outside of the OS**, scroll down to the expanded window that appears, and then select **Download**.
3. A pop-up that asks what you want to do with the file opens. Select **Open** or **Save As**. The latest version of the diagnostics tool opens or downloads to the selected location.

## Downloading Remote HP PC Hardware Diagnostics UEFI by product name or number

You can download Remote HP PC Hardware Diagnostics UEFI by product name or number.



---

**NOTE:** For some products, you might have to download the software by using the product name or number.

---

1. Go to <http://www.hp.com/support>.
2. Select **Software and Drivers**, select your type of product, enter the product name or number in the search box that is displayed, select your computer, and then select your operating system.
3. In the **Diagnostics** section, follow the on-screen instructions to select and download the **Remote UEFI** version for the product.

## Customizing Remote HP PC Hardware Diagnostics UEFI settings

Using the Remote HP PC Hardware Diagnostics setting in Computer Setup (BIOS), you can perform several customizations.

- Set a schedule for running diagnostics unattended. You can also start diagnostics immediately in interactive mode by selecting **Execute Remote HP PC Hardware Diagnostics UEFI**.
- Set the location for downloading the diagnostic tools. This feature provides access to the tools from the HP website or from a server that has been preconfigured for use. Your computer does not require the traditional local storage, such as a hard drive or USB flash drive, to run remote diagnostics.

- Set a location for storing the test results. You can also set the user name and password that you use for uploads.
- Display status information about the diagnostics run previously.

To customize Remote HP PC Hardware Diagnostics UEFI settings, follow these steps:

1. Turn on or restart the computer, and when the HP logo appears, press **f10** to enter Computer Setup.
2. Select **Advanced**, and then select **Settings**.
3. Make your customization selections.
4. Select **Main**, then select **Save Changes and Exit** to save your settings.

Your changes take effect when the computer restarts.

# 10 Specifications

This chapter provides specifications for your computer system.

## Computer specifications

This section provides specifications for your computer. When you travel with your computer, the computer dimensions and weights, as well as input power ratings and operating specifications, provide helpful information.

**Table 10-1** Computer specifications

	Metric	U.S.
<b>Dimensions</b>		
Width	385.0 mm	15.2 in
Depth	269.0 mm	10.6 in
Height (front to back)	23.8 mm to 28.4 mm	0.9 in to 1.1 in
<b>Weight</b>		
	2.4 kg	5.4 lb
<b>Input power</b>		
Operating voltage and current	19.5 V DC @ 2.31 A - 45 W	
	19.5 V DC @ 3.33 A - 65 W	
	19.5 V DC @ 4.62 A - 90 W	
	19.5 V DC @ 7.70 A - 150 W	
	19.5 V DC @ 10.3 A - 200 W	
<b>Temperature</b>		
Operating	5°C to 35°C	41°F to 95°F
Nonoperating	-20°C to 60°C	-4°F to 140°F
<b>Relative humidity</b> (noncondensing)		
Operating	10% to 90%	
Nonoperating	5% to 95%	
<b>Maximum altitude</b> (unpressurized)		
Operating	-15 m to 3,048 m	-50 ft to 10,000 ft

**Table 10-1 Computer specifications (continued)**

	Metric	U.S.
Nonoperating	-15 m to 12,192 m	-50 ft to 40,000 ft

 **NOTE:** Applicable product safety standards specify thermal limits for plastic surfaces. The device operates well within this range of temperatures.

## Display specifications

This section provides specifications for your display.

**Table 10-2 Display specifications**

	Metric	U.S.
Active diagonal size	40.6 cm	16 in
Resolution	2560 × 1600 (UHD) 1920 × 1200 (FHD)	
Surface treatment	Antiglare (FHD, UHD panels) Brightview (OLED panel)	
Brightness	500 nits 400 nits 300 nits	
Viewing angle	UWVA	
Backlight	WLED AMOLED	
Display panel interface	eDP	

## Solid-state drive specifications

This section provides specifications for your solid-state drives.

**Table 10-3 Solid-state drive specifications**

	256 GB*	512 GB*	1TB*
<b>Dimensions</b>			
Height	1.0 mm	1.0 mm	1.0 mm
Length	50.8 mm	50.8 mm	50.8 mm
Width	28.9 mm	28.9 mm	28.9 mm
Weight	< 10 g	< 10 g	< 10 g
<b>Interface type</b>	PCIe	PCIe	PCIe

**Table 10-3 Solid-state drive specifications (continued)**

	256 GB*	512 GB*	1 TB*
Ready time, maximum (to not busy)	1.0 ms	< 1.0 ms	1.0 ms
Access times, logical	0.1 ms	0.1 ms	0.1 ms
<b>Transfer rate</b>			
Sequential read	up to 2150 MBps	up to 2150 MBps	up to 2150 MBps
Random read	Up to 300,000 IOPs	Up to 300,000 IOPs	Up to 300,000 IOPs
Sequential write	up to 1550 MBps	up to 1550 MBps	up to 1550 MBps
Random write	Up to 100,000 IOPs	Up to 100,000 IOPs	Up to 100,000 IOPs
<b>Total logical sectors</b>	468,883,296	1,000,215,216	1,500,336,388
<b>Operating temperature</b>	<b>0°C to 70°C</b> (32°F to 158°F)	<b>0°C to 70°C</b> (32°F to 158°F)	<b>0°C to 70°C</b> (32°F to 158°F)

\*1 GB = 1 billion bytes when referring to hard drive storage capacity. Actual accessible capacity is less. Actual drive specifications might differ slightly.

 **NOTE:** Certain restrictions and exclusions apply. Contact support for details.

# 11 Power cord set requirements

This chapter provides power cord requirements for countries and regions.

The wide-range input feature of the computer permits it to operate from any line voltage from 100 V AC to 120 V AC, or from 220 V AC to 240 V AC.

The three-conductor power cord set included with the computer meets the requirements for use in the country or region where the equipment is purchased.

Power cord sets for use in other countries or regions must meet the requirements of the country and region where the computer is used.

## Requirements for all countries

These power cord requirements are applicable to all countries and regions.

- The length of the power cord set must be at least **1.0 m** (3.3 ft) and no more than **2.0 m** (6.5 ft).
- All power cord sets must be approved by an acceptable accredited agency responsible for evaluation in the country or region where the power cord set will be used.
- The power cord sets must have a minimum current capacity of 10 A and a nominal voltage rating of 125 V AC or 250 V AC, as required by the power system of each country or region.
- The appliance coupler must meet the mechanical configuration of an EN 60 320/IEC 320 Standard Sheet C13 connector for mating with the appliance inlet on the back of the computer.

## Requirements for specific countries and regions

To determine power cord requirements for specific countries and regions, use this table.

**Table 11-1** Power cord requirements for specific countries and regions

Country/region	Accredited agency	Applicable note number
Argentina	IRAM	1
Australia	SAA	1
Austria	OVE	1
Belgium	CEBEC	1
Brazil	ABNT	1
Canada	CSA	2

**Table 11-1 Power cord requirements for specific countries and regions (continued)**

Country/region	Accredited agency	Applicable note number
Chile	IMQ	1
Denmark	DEMKO	1
Finland	FIMKO	1
France	UTE	1
Germany	VDE	1
India	BIS	1
Israel	SII	1
Italy	IMQ	1
Japan	JIS	3
Netherlands	KEMA	1
New Zealand	SANZ	1
Norway	NEMKO	1
The People's Republic of China	CCC	4
Saudi Arabia	SASO	7
Singapore	PSB	1
South Africa	SABS	1
South Korea	KTL	5
Sweden	SEMKO	1
Switzerland	SEV	1
Taiwan	BSMI	6
Thailand	TISI	1
United Kingdom	ASTA	1
United States	UL	2

1. The flexible cord must be Type HO5VV-F, three-conductor, 0.75 mm<sup>2</sup> conductor size. Power cord set fittings (appliance coupler and wall plug) must bear the certification mark of the agency responsible for evaluation in the country or region where it will be used.
2. The flexible cord must be Type SVT/SJT or equivalent, No. 18 AWG, three-conductor. The wall plug must be a two-pole grounding type with a NEMA 5-15P (15 A, 125 V AC) or NEMA 6-15P (15 A, 250 V AC) configuration. CSA or C-UL mark. UL file number must be on each element.
3. The appliance coupler, flexible cord, and wall plug must bear a T mark and registration number in accordance with the Japanese Dentori Law. The flexible cord must be Type VCTF, three-conductor, 0.75 mm<sup>2</sup> or 1.25 mm<sup>2</sup> conductor size. The wall plug must be a two-pole grounding type with a Japanese Industrial Standard C8303 (7 A, 125 V AC) configuration.
4. The flexible cord must be Type RVV, three-conductor, 0.75 mm<sup>2</sup> conductor size. Power cord set fittings (appliance coupler and wall plug) must bear the CCC certification mark.

5. The flexible cord must be Type H05VV-F three-conductor, 0.75 mm<sup>2</sup> conductor size. KTL logo and individual approval number must be on each element. Approval number and logo must be printed on a flag label.
6. The flexible cord must be Type HVCTF three-conductor, 1.25 mm<sup>2</sup> conductor size. Power cord set fittings (appliance coupler, cable, and wall plug) must bear the BSMI certification mark.
7. For 127 V AC, the flexible cord must be Type SVT or SJT 3-conductor, 18 AWG, with plug NEMA 5-15P (15 A, 125 V AC), with UL and CSA or C-UL marks. For 240 V AC, the flexible cord must be Type H05VV-F three-conductor, 0.75 mm<sup>2</sup> or 1.00 mm<sup>2</sup> conductor size, with plug BS 1363/A with BSI or ASTA marks.

---

## 12 Swelling or deformation of notebook battery

To protect your hardware from potential damage, HP recommends that if you are experiencing battery swelling, stop using the notebook until you can replace the battery.

You can contact HP to understand what battery replacement options are available. To learn more about Lithium-ion batteries and the factors that can accelerate battery swelling, see [https://support.hp.com/us-en/document/ish\\_6824662-6824706-16](https://support.hp.com/us-en/document/ish_6824662-6824706-16).

## Swollen notebook batteries

You might notice that your notebook battery has become somewhat deformed or swollen over time. In some cases, the battery swelling might be significant enough to impact other components of the system including the touchpad, keyboard, and chassis.

### Swollen battery is not a safety issue

A swollen battery does not present a safety issue. It is the result of the generation of gases per the normal degradation of the battery cell over time.

HP has worked closely with our battery cell suppliers and third-party industry experts to help minimize the potential for HP batteries to swell over time and to identify that swollen batteries are not a safety issue.

### Discontinue using a swollen battery

To protect your hardware from potential damage, HP recommends that, if you are experiencing battery swelling, you stop using the notebook until the battery can be replaced.

You can contact <https://www.hp.com/go/contacthp> to understand what battery replacement options are available.

### Replace a swollen battery

If a battery is under warranty, HP will replace the battery per the terms and conditions of the HP Worldwide Limited Warranty or applicable HP Care Packs.

For batteries no longer under warranty, contact HP to purchase a genuine HP replacement battery.

## Minimize battery swelling

Multiple factors can accelerate battery swelling.

To help mitigate battery swelling over time, you can use either HP Adaptive Battery Optimizer (consumer notebooks) or HP Battery Health Manager (commercial notebooks) settings to improve battery longevity and performance for various use scenarios.

### HP Adaptive Battery Optimizer (consumer notebooks)

HP Adaptive Battery Optimizer technology can help mitigate the factors that cause the battery to swell. It is available on select HP OMEN, HP Spectre, HP Pavilion, and HP ENVY notebook computers.

HP Adaptive Battery Optimizer has been available on select gaming notebooks since 2019 and select consumer notebooks since 2020. To learn more about enabling HP Adaptive Battery Optimizer on your HP notebook, see <https://support.hp.com/us-en/document/c06310986>.

### HP Battery Health Manager (commercial notebooks)

HP Battery Health Manager provides an easy-to-manage solution to help mitigate factors that cause the battery to swell. It is available on select HP ProBook and HP EliteBook notebook computers.

HP Battery Health Manager is available on select commercial notebooks manufactured since 2016. To learn more about HP Battery Health Manager, see [https://support.hp.com/us-en/document/ish\\_4449597-3519507-16](https://support.hp.com/us-en/document/ish_4449597-3519507-16).

---

# 13 Recycling

When a nonrechargeable or rechargeable battery has reached the end of its useful life, do not dispose of the battery in general household waste. Follow the local laws and regulations in your area for battery disposal.

HP encourages customers to recycle used electronic hardware, HP original print cartridges, and rechargeable batteries. For more information about recycling programs, see the HP website at <http://www.hp.com/recycle>.

# Index

## A

- AC adapter and battery light, identifying 10
- AC adapters, spare part numbers 25
- action key, identifying 16
- audio board
  - illustrated 23
  - removal 51
  - spare part number 23
  - spare part numbers 51
- audio-out (headphone)/audio-in (microphone) combo jack, identifying 9
- audio, product description 2

## B

- backup, creating 74
- backups 74, 75
- battery
  - illustrated 23
  - spare part number 23
- battery swelling 93
- BIOS
  - determining version 72
  - downloading an update 72, 73
  - starting the Setup Utility 71
  - updating 72
- Bluetooth label 19
- boot order, changing 77
- bottom components 18
- bottom cover
  - illustrated 23
  - removal 38
  - spare part number 23, 38
- buttons
  - left touchpad 13, 14
  - power 17
  - right touchpad 13, 14

## C

- cables
    - spare part numbers 25
  - calculator key, identifying 17
  - camera
    - identifying 12
  - camera light, identifying 12
  - camera privacy cover, identifying 12
  - caps lock light 15
  - caring for your computer 32
  - cautions
    - electrostatic discharge 27, 29
  - cleaning your computer 32
    - caring for wood veneer 34
    - disinfecting 33
    - HP Easy Clean 32
    - removing dirt and debris 32
  - components
    - bottom 18
    - display 11
    - keyboard area 13
    - left side 7
    - lights 14
    - rear 9
    - right side 7
    - touchpad 13
  - computer major components 21
  - computer specifications 87
  - connectors
    - power 8, 10
  - control zone 13
- ## D
- display
    - specifications 87, 88
  - display assembly
    - subcomponents 24
  - display back cover
    - illustrated 24
    - spare part number 24

- display bezel
  - illustrated 24
  - spare part number 24
- display cable
  - illustrated 24
  - spare part number 24
- display components 11
- display panel
  - illustrated 24
  - product description 1
  - spare part number 24

## E

- electrostatic discharge (ESD) 27, 29
  - preventing damage 27, 29, 30
- esc key, identifying 16

## F

- fan
  - illustrated 23
  - removal 55
  - spare part number 23, 55
- fn key, identifying 16
- fn lock light, identifying 15

## G

- graphics, product description 1
- grounding methods 27, 29, 30
- guidelines
  - packaging 27, 34
  - transporting 27, 34
  - workstation 27, 28

## H

- hard drive
  - product description 2
  - specifications 87
- HDMI port
  - identifying 9

- heat sink
  - illustrated 23
  - removal 53
  - spare part number 23
  - spare part numbers 53
- hinge
  - illustrated 24
  - spare part number 24
- hinge cover
  - illustrated 24
  - spare part number 24
- HP OMEN Gaming Hub, using 17
- HP PC Hardware Diagnostics UEFI
  - downloading 83
  - failure ID code 82
  - HP Hotkey Support software 83
  - starting 82, 83
  - using 82
- HP PC Hardware Diagnostics Windows
  - accessing 79
  - downloading 80
  - failure ID code 79
  - installing 81
  - using 79
- HP Recovery media recovery 76
- HP Sure Recover 77

**I**

- illustrated parts catalog 21
- IMAX Enhanced Mode, identifying 11
- infrared board
  - illustrated 23
  - spare part number 23
- Infrared board removal 62
- spare part number 62
- integrated numeric keypad, identifying 17
- internal microphones, identifying 12

**J**

- jacks
  - audio-out (headphone)/audio-in (microphone) 9
  - network 10
  - RJ-45 (network) 10

**K**

- keyboard
  - product description 3
- keyboard with top cover
  - spare part numbers 69
- keypad, integrated numeric 17
- keys
  - action 16
  - calculator 17
  - esc 16
  - fn 16
  - num lock 17
  - OMEN 17
  - Windows 16
  - Windows Copilot 16

**L**

- labels
  - Bluetooth 19
  - regulatory 19
  - serial number 19
  - service 19
  - wireless certification 19
  - WLAN 19
- left control zone, identifying 13
- left side components 7
- lights
  - AC adapter and battery 10
  - camera 12
  - caps lock 15
  - fn lock 15
  - mute 15
  - power 15
  - RJ-45 (network) status 10
  - touchpad 13, 15
- low blue light mode 11

**M**

- memory module
  - product description 1
- memory modules
  - illustrated 23
  - removal 46
  - spare part number 23
  - spare part numbers 46
- microphone
  - product description 2
- model name 1
- mute light, identifying 15

**N**

- network jack, identifying 10
- num lock key, identifying 17

**O**

- OMEN Gaming Hub Graphics Mode, using 18
- OMEN key, identifying 17
- operating system, product description 3

**P**

- packaging guidelines 27, 34
- pointing device, product description 3
- ports
  - HDMI 9
  - product description 2
  - USB 7-9
  - USB Type-C power connector and port with HP Sleep and Charge and DisplayPort output 8
- power button, identifying 17
- power connector
  - identifying 8, 10
- power cord
  - requirements for all countries 90
  - requirements for specific countries and regions 90
  - set requirements 90
- power cords, spare part numbers 25
- power light, identifying 15
- power requirements, product description 3
- primary storage
  - product description 2
- processor
  - product description 1
- product description
  - audio 2
  - display panel 1
  - graphics 1
  - hard drive 2
  - keyboard 3
  - memory module 1
  - microphone 2
  - operating system 3
  - pointing device 3
  - ports 2
  - power requirements 3
  - primary storage 2
  - processors 1
  - product name 1
  - RJ-45 (network) jack 2
  - security 3

- serviceability 6
- solid-state drive 2
- video 2
- wireless 2
- product name 1
- product name and number, computer 19

**R**

- rear components 9
- recovery 74, 76
  - discs 76
  - media 76
  - USB flash drive 76
- recovery media 75
  - creating using HP Cloud Recovery Download Tool 75
  - creating using Windows tools 75
- regulatory information
  - regulatory label 19
  - wireless certification labels 19
- Remote HP PC Hardware Diagnostics UEFI settings
  - customizing 85
  - using 85
- removal and replacement
  - procedures 37, 50
  - solid-state drive 47
- restoring 74
- restoring and recovery
  - methods 76
- right control zone, identifying 13
- right side components 7
- RJ-45 (network) jack, identifying 10
- RJ-45 (network) jack, product description 2
- RJ-45 (network) status lights, identifying 10

**S**

- Screw Kit, spare part number 25
- security, product description 3
- serial number, computer 19
- service labels, locating 19
- serviceability, product description 6
- solid-state drive
  - illustrated 23
  - product description 2
  - removal and replacement 47
  - spare part number 23

- specifications 88
- spare part country codes 69
- speaker
  - illustrated 23
  - removal 50
  - spare part number 23, 50
- speakers 19
- special keys
  - identifying 15
  - using 15
- specifications
  - computer 87
  - display 87, 88
  - hard drive 87
  - solid-state drive 88
- static electricity 27, 29
- support information 34
- swelling or deformation of notebook battery 93
- system board
  - illustrated 23
  - removal 59
  - spare part number 23
  - spare part numbers 59
- system restore 76
- system restore point, creating 75

**T**

- top cover/keyboard
  - illustrated 22
  - spare part number 22
- touchpad
  - illustrated 23
  - removal 51
  - settings 13
  - spare part number 23
  - spare part numbers 51
- touchpad buttons
  - identifying 13, 14
- touchpad cable
  - spare part number 25
- touchpad components 13
- touchpad light, identifying 13, 15
- touchpad settings, adjusting 13
- touchpad zone, identifying 13, 14
- transporting guidelines 27, 34
- traveling with the computer 19

**U**

- USB board
  - illustrated 23
  - removal 57, 58
  - spare part number 23, 57, 58

- USB board cable
  - spare part number 25
- USB port, identifying 7-9
- USB Type-C power connector and port with HP Sleep and Charge and DisplayPort output, identifying 8

**V**

- vents, identifying 7-9, 19
- video, product description 2

**W**

- wake-on-voice 11
- Windows
  - backup 74
  - recovery media 74
  - system restore point 75
- Windows Copilot key, identifying 16
- Windows key, identifying 16
- Windows tools, using 75
- wireless antennas
  - illustrated 24
  - spare part number 24
- wireless antennas, identifying 12
- wireless certification label 19
- wireless, product description 2
- WLAN antennas, identifying 12
- WLAN device 19
- WLAN label 19
- WLAN module
  - illustrated 23
  - removal 55
  - spare part number 23
  - spare part numbers 55
- workstation guidelines 27, 28