



152 Robbins Rd, Downingtown, PA, 19335, USA - [HuddleCamHD.com](http://HuddleCamHD.com) | 1 800 - 486-5276

## HuddleCamHD 10X-USB2

USB 2.0 PTZ CAMERA

INSTALLATION & OPERATION MANUAL



Please check [HUDDLECAMHD.com](http://HUDDLECAMHD.com) for the most up to date version of this document

Ver 1.2 11/20



## Precautions.....

### Safety Tips.....

- Please read this manual carefully before using the camera.
- Avoid damage from stress, violent vibration or liquid intrusion during transportation, storage or installation.
- Take care of the camera during installation to prevent damage to the camera case, ports, lens or PTZ mechanism.
- Do not apply excessive voltage. (Use only the specified voltage.) Otherwise, you may experience electrical shock.
- Keep the camera away from strong electromagnetic sources.
- Do not aim the camera at bright light sources (e.g. bright lights, the sun, etc.) for extended periods of time.
- Do not clean the camera with any active chemicals or corrosive detergents.
- Do not disassemble the camera or any of the camera's components. If problems arise, please contact your authorized dealer.
- After long term operation, moving components can wear down. Contact your authorized dealer for repair.

### Supplied Accessories.....

- 10X Zoom 1080p USB 2.0 HD Video Conference Camera
- 12V/2.0A DC Power Adapter
- USB 2.0 A-B cable(16ft/4.9m)
- Serial Control Cable
- Wall mount
- RS-232C to RS-485 Adapter
- IR Remote Controller
- Quick Start Guide

## Physical Description.....

### 1. Front View.....



1. Lens
2. IR Receiver  
To receive IR remote controller signal.
3. Power LED  
Blue LED lights when unit is powered, LED is dark for Stand-By status.
4. IR Receiver  
To receive IR remote controller signal.

## 2. Rear View.....

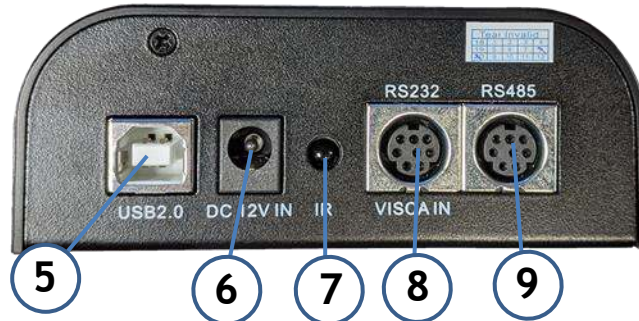

### 5. DC IN 12V Socket

Only use the Power Adapter supplied with this camera.

### 6. IR Receiver

To receive IR remote controller signals.

### 7. RS232 IN Port

For hard wired remote control from a 3<sup>rd</sup> party PC, joystick, etc...

### 8. RS485 IN Port

For hard wired remote control from a 3<sup>rd</sup> party PC, joystick, etc...

### 9. USB 2.0 Interface

For connection to PC USB 2.0 port. Will also function in a USB 3.0 port as USB 2.0 device.

### 3. Bottom View.....



#### 1. Tripod

Will accept 1/4-20 bolt from 3<sup>rd</sup> party tripod, wall or ceiling mount using included tripod adapter.

[Cable Connection Info.....](#)

[VISCA RS-232C - IN Reference.....](#)

VISCA RS-232C IN

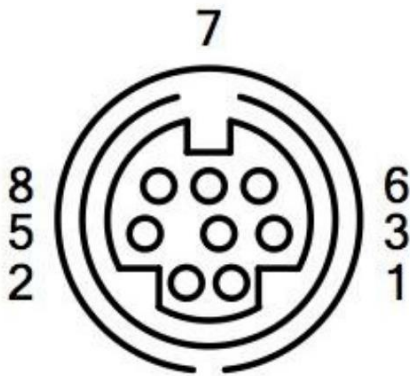

Pin S/N	Function
1	DTR IN
2	DSR IN
3	TXD IN
4	GND
5	RXD IN
6	GND
7	IR Commander Signal OUTPUT
8	NO Connection

[VISCA RS-485 - In Reference.....](#)

VISCA RS-485 IN

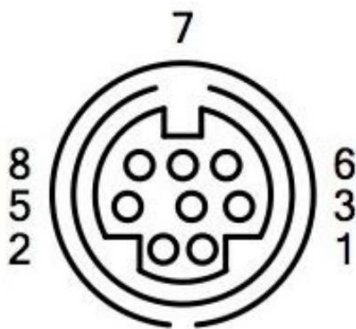

Pin S/N	Function	
	RS-232	RS-485
1	DTR OUT	TX+
2	DSR OUT	TX-
3	TXD OUT	
4	GND	
5	RXD OUT	
6	GND	
7		RS-485 -
8		RS-485 +



## OSD MENU.....

**On Screen Display Menu** - Use the OSD menu to access and change the camera's settings.

**Note:** You cannot manually move the camera (pan / tilt) when the OSD menu is visible on the screen.

### The Dome OSD Menu is as follows:

- Protocol
  - Dome Address Default: 1
    - 1 - 7
  - Dome Protocol Default: VISCA
    - VISCA, PELCO-D
  - Baud Rate Default: 9600
    - 2400, 4800, 9600, 38400
- Settings
  - IR Address Default: 1
    - 1 - 3
  - Pan Speed Default: 11
    - 1 - 24
  - Tilt Speed Default: 11
    - 1 - 18
  - Preset Freeze Default: Off
    - On, Off
  - Preset Resume Default: Off
    - Off, 30, 60, 90
- Information
  - Version
  - Model
  - Date
- Language
  - English

**The Lens OSD Menu is as follows:**

- Exposure
  - Brightness Default: 50
    - 1 - 255 (increments of 5)
  - Backlight Default: Off
    - On, Off
  - AE (Auto Exposure) Default: Auto
    - Auto, Shutter
  - Shutter Default: 1/125
    - 1/25, 1/30, 1/50, 1/60, 1/75, 1/90, 1/100, 1/120, 1/125, 1/150, 1/180, 1/215, 1/250, 1/300, 1/350, 1/425, 1/500, 1/600, 1/725, 1/1000, 1/1250, 1/1500, 1/1750, 1/2000, 1/2500, 1/3000, 1/3500, 1/4000, 1/6000, 1/10000
  - Flicker Default: 60
    - 50 / 60
- Color
  - Hue Default: 50
    - 1 - 100
  - Saturation Default: 50
    - 1 - 100
  - Sharpness Default: 50
    - 1 - 127
  - WB (White Balance) Default: Auto
    - Auto, Manual
  - Color Temp Default: 4900
    - 4000 - 5400 (increments of 100)
- Image
  - Image Flip Default: Off
    - Mirror, Off, All, Flip
  - Frame (frames per second) Default: 30
    - 25 / 30
  - Image Mode Default: Normal
    - Clear, Bright, Beauty, Normal



## IR Remote Controller (Note: Some buttons do not operate for all camera models)

1. **Reset:**  
Restarts the camera and restores it to Factory Default settings.  
(Note: Will delete all memory).
2. **Camera Selection**  
Select Camera ID: 1, 2 or 3
3. **Preset Positions**  
1-9: Preset Positions  
Set: Setting Preset Position  
Clear: Clear Preset Position  
Call: Call Preset Position  
**Note:** To Set / Call preset position 1, you should press number key "1", then press Set / Call to Set or Call the position.
4. **Fast Zoom in/out Control Zone**  
+: Zoom in quickly  
-: Zoom out quickly
5. **Pan/Tilt Controller**  
  - ↑ Move Up
  - ↓ Move Down
  - ← Move Left
  - Move Right
  - ↻ Auto Pan
6. **Additional Function Zone**  
Freeze: Image Freeze  
BL: Back-light Compensation  
WB: White Balance  
AE: Auto Exposure  
D Zoom: Digital Zoom  
HDMI: Swap to HDMI video output  
DVI: Swap to DVI video output  
Format: Swap between different formats
7. **Power Supply Switch**  
Power On / Off button
8. **OSD Menu Zone**  
Dome OSD: Enter Pan Tilt Zoom OSD menu  
Lens OSD: Enter lens OSD menu
9. **Slow Zoom In/Out Zone**  
+: Zoom in slowly  
-: Zoom out slowly
10. **Focus Control Zone**  
Auto: Turn on auto focus  
Manual: Turn on manual focus  
Far: Set focus at farther distance  
Near: Set focus at nearer distance
11. **Pan/Tilt Function Zone**  
L-Limit: Set left boundary limit scanning position  
Scan: Enable Boundary Scanning (Auto Panning)  
R-Limit: Set right boundary limit scanning position  
Home: Go to camera's Home position  
Tour: Enable automatic patrol tour of presets  
Rev: Enable image flip for ceiling mounting

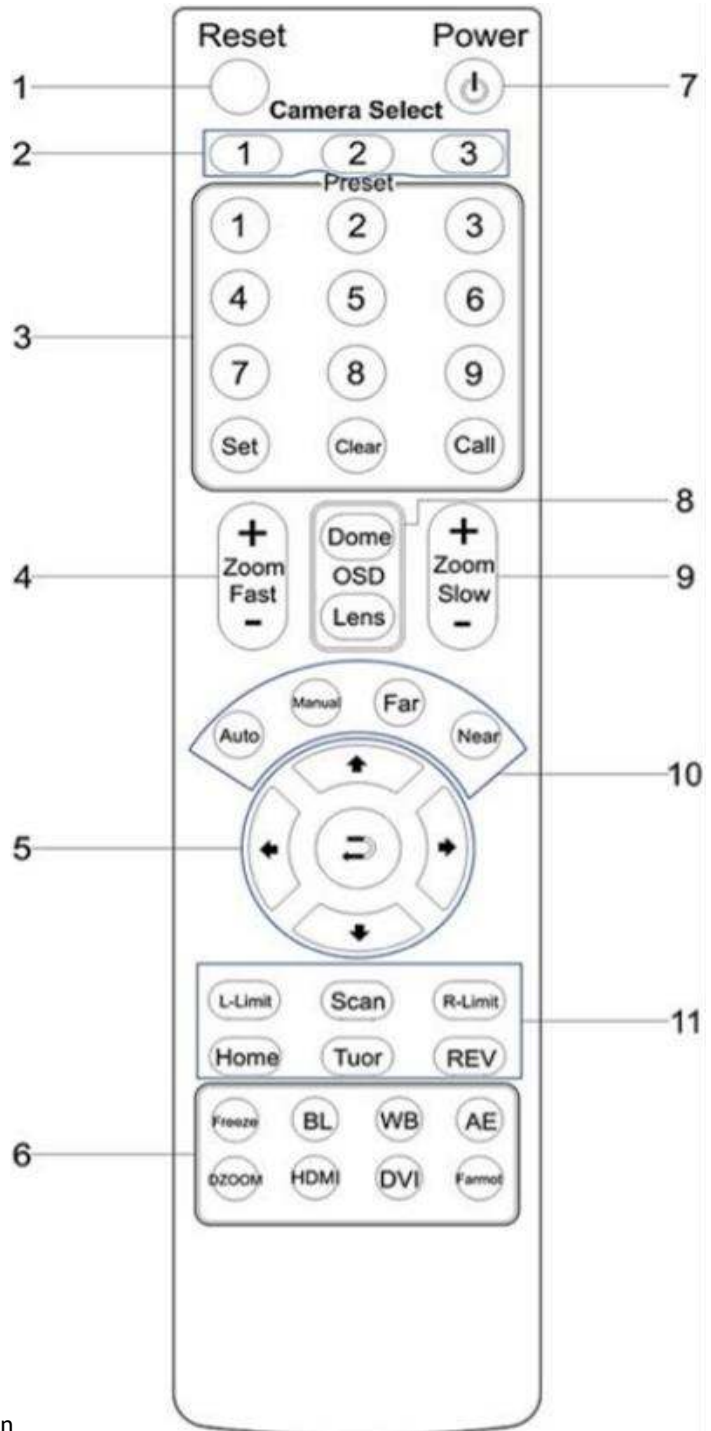

## Connection Instructions.....

1. Connect included Power Supply to the camera.
2. Wait for camera to come to Home Position.
3. Connect included USB 2.0 cable to camera and USB port of PC.
4. Select and configure camera in your software of choice.

**NOTE:** Failure to follow this sequence may result in no connection to PC.

## Care Of The Unit.....

Remove dust or dirt on the surface of the lens with a blower (commercially available).

## Installation Instructions.....

### Desktop Installation.....

When using the HuddleCamHD camera on a desk, make sure that it will stand level. If you want to use the camera on an incline, make sure the angle is less than 15 degrees to ensure that the camera's pan and tilt mechanism operates normally.

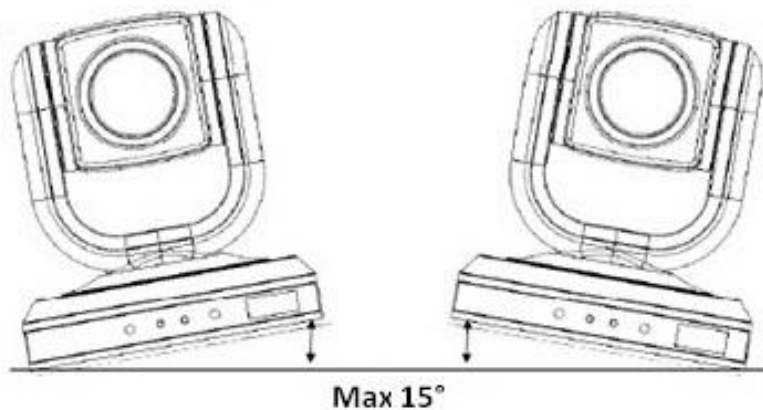

## [Tripod Installation.....](#)

When using the HuddleCamHD camera with a tripod, screw the tripod to the bottom of the camera. The tripod screw must fit below specifications:

**Note:** Tripod must stand on a level surface.

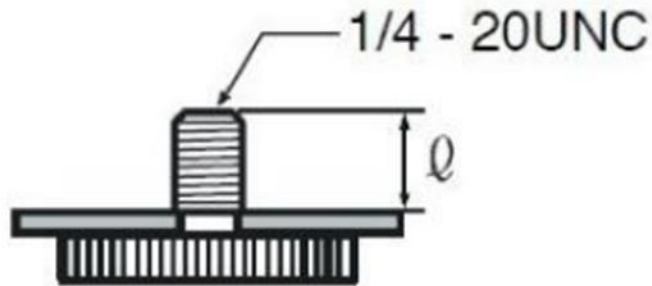

$$q = 5 - 7 \text{ mm}$$



## USB Connection.....

### **Important Notes Regarding USB Connectivity:**

USB 3.0 ports are backwards compatible with USB 2.0 devices. USB 2.0 ports are not completely forward compatible with USB 3.0 devices (some USB 3.0 devices will connect to USB 2.0 with limited functionality).

External USB hubs should be avoided (i.e. give the camera its own USB port on the device) as they are not well suited to transmitting HD video reliably.

USB extension systems must be fully compatible with the version of USB that you are using and must utilize an external power supply, when required. Caution: Some “compatible” USB 3.0 extenders do not actually have the full 5Gbps bandwidth required for uncompressed HD video - so check bandwidth specs. Always connect the HuddleCamHD camera directly to the device in order to associate the UVC drivers before attempting to use any extension system.

USB 3.0 power saving settings in the device’s operating system should be turned off completely for reliable USB 3.0 camera connectivity.

### **HuddleCamHD Cameras**

All HuddleCamHD cameras utilize the UVC (USB Video Class) drivers that are built into Windows, Mac OS and Linux to stream HD video to your device via your device’s USB port (*USB 2.0 or USB 3.0 depending upon HuddleCamHD camera*). When your device successfully recognizes the camera, your device will register the HuddleCamHD camera as an “imaging device”.

You can see this in your Windows Device Manager program (type “device manager” into the Windows search tool) as shown in the screenshot, below:

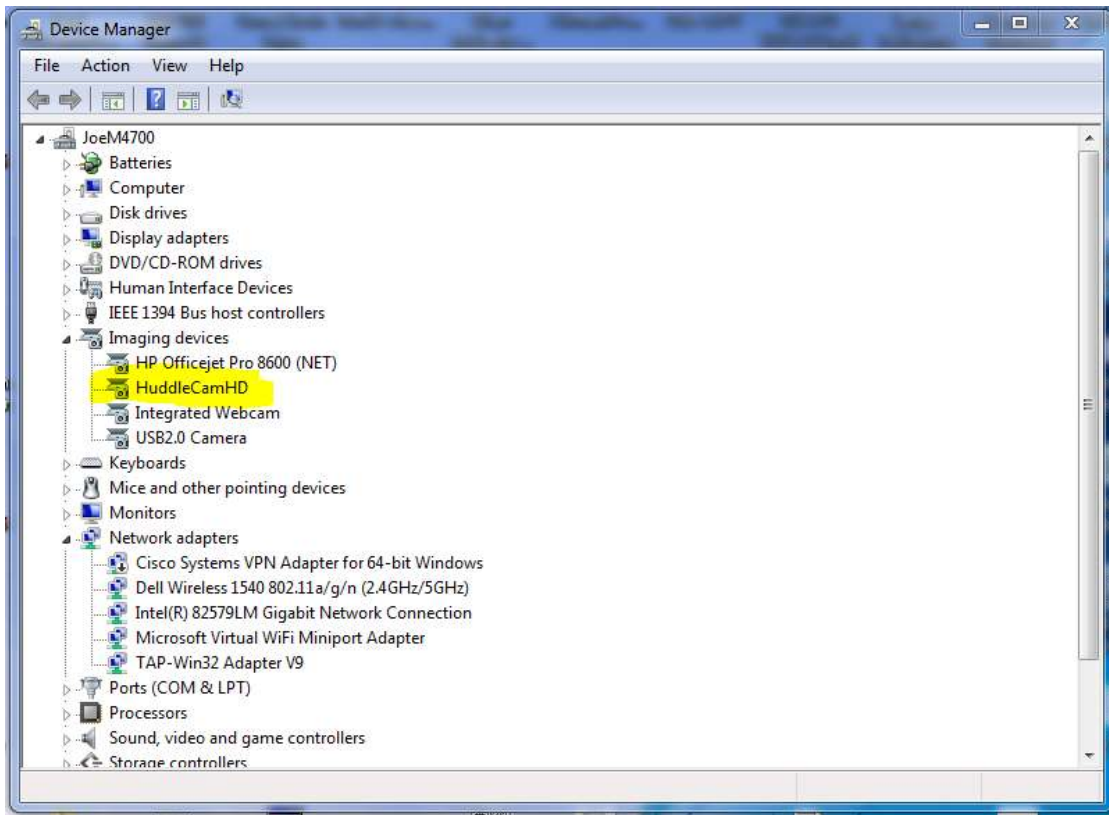

In this example, you can see the HuddleCamHD camera in use connected as a fully functional USB 3.0 device (HuddleCamHD) as well as a USB 2.0 device with limited functionality (USB2.0 Camera).

If your device has not connected to or has not recognized the HuddleCamHD camera as an imaging device (in which case, you may see a new “unknown device”, “Westbridge” or “CYTFX3” labeled device show up in Device Manager’s “Universal Serial Bus Controllers” section rather than in the “Imaging Devices” section), the HuddleCamHD camera will not be available to programs that utilize a camera. In this case, try restarting the device and reconnecting the camera via USB (*USB 2.0 or USB 3.0 depending upon HuddleCamHD camera*).

Similarly, you can see a connected device in System Information on a MAC. See screenshot below:



152 Robbins Rd, Downingtown, PA, 19335, USA - [HuddleCamHD.com](http://HuddleCamHD.com) | 1 800 - 486-5276



In this example, you can see the HuddleCamHD camera in use connected as a fully functional USB 3.0 device “HuddleCamHD” as well as a “USB2.0 camera” with limited functionality (USB2.0 camera).



152 Robbins Rd, Downingtown, PA, 19335, USA - HuddleCamHD.com | 1 800 - 486-5276

[Troubleshooting.....](#)

Problem	Cause	Resolution
There is no power to the camera.	Power adapter is disconnected from mains or from camera.	Check the connections between the camera, power adapter and mains. If anything is disconnected, reconnect it.
Camera will not connect to the PC via USB.	USB cable is bad.	Try new USB Cable
	Camera connects sometimes.	Connect USB only after camera has completely booted.
Camera unable to pan, tilt, and/or zoom.	Menu is currently displayed on the screen.	Retry after exiting the menu.
	Pan, tilt or zoom range limit was reached.	Try to pan/tilt/zoom in the other direction.
Remote control not working.	The “camera select” button on the remote control is not set to match the “IR address” set on the camera dip switch.	Choose the correct “IR select” number to match camera settings.
Camera cannot be controlled via VISCA.	The connection between the PC and camera is incorrect.	Refer to Cable Connection Info section of this manual.
	Commands being sent are incorrect.	Refer to VISCA manual.
The Camera is not working at all.	No response or image from camera.	Disconnect power, and wait a few minutes, then connect the power again. Retry.



## Specs.....

Model Number: HC10X-USB2-(xx) Color (xx): BK=Black; WH=White

### Camera & Lens

- Video CMOS Sensor 1/2.9" HD Sony CMOS, 2.1 Mega Pixel
- Frame Rate 30fps 1920 x 1080
- Lens Zoom 10X Optical Zoom f=4.7 47mm
- Min Lux 0.1 Lux at F1.6
- Field of View 8° (tele) to 60° (wide)
- Warranty 2 Years

### Pan/Tilt Movement

- Pan Movement ±175°
- Tilt Rotation Up: 90°, Down: 30°
- Presets 64 Presets

### Rear Board Connectors

- Video Interface USB 2.0, UVC 1.5
- Control Signal Interface UVC 1.5 - Mini DIN-8 (RS232 IN, RS485 IN, Pelco-D/P IN/OUT)
- Control Signal Config. Dome - On Screen Display Menu
- Baud Rate 9600 bps
- Power Supply Interface DC 12V 2A

### Electrical Index

- Power Supply Adapter 12V DC 2A
- Input Voltage 12V DC (10.5-14V DC)
- Input Power 24W (Max)
- Working Environment Indoor

### Physical

- Material Aluminum, Plastic
- Dimensions 4.88"W x 5.5"H x 4.75"D (6" H w/ Tilt up)  
124mm x 139mm x 120mm (152mm H w/ Tilt up)
- Weight 1.66 lbs (.75 kg)
- Box Dimensions 8.75" x 8.88" x 7" (222mm x 225mm x 178mm)
- Boxed Weight 3.66 lbs | 1.66 kg
- Color Black & White
- Operating Temperature 32°F to + 113°F (0°C to +45°C)
- Storage Temperature -14°F to 140°F (-10°C +60°C)
- Working Environment Indoor only