

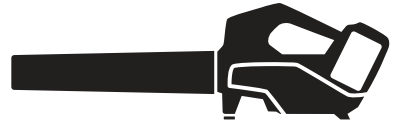

**Husqvarna**<sup>®</sup>



120iB

# Contents

Introduction.....	2	Troubleshooting.....	17
Safety.....	3	Transportation, storage and disposal.....	18
Assembly.....	14	Technical data.....	18
Operation.....	14	EC Declaration of Conformity.....	20
Maintenance.....	16		

# Introduction

## Product overview

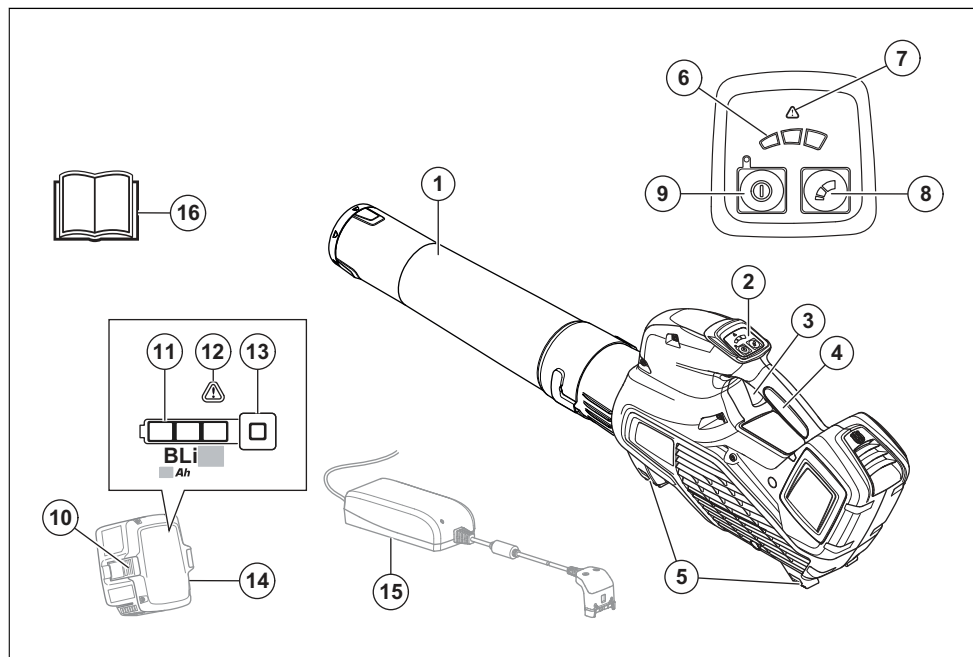

1. Blower nozzle
2. Keypad
3. Power trigger
4. Handle
5. Supports
6. Airflow indicator
7. Warning indicator (error LED)
8. Mode control
9. Start/stop button
10. Battery release button
11. Battery status
12. Warning indicator (error LED)
13. Power and warning indicator
14. Battery, included in the Husqvarna 120iB blower kit only
15. Battery charger, included in the Husqvarna 120iB blower kit only
16. Operator's manual

## Product description

Husqvarna 120iB is blower model with an electrical motor.

We have a policy of continuous product development and therefore reserve the right to modify the design and appearance of products without prior notice.

## Intended use

This product is designed for blowing leaves and other debris from lawns, pathways, asphalt roads and the like. The product is designed for household use.

## Symbols on the product



**WARNING!** This product is dangerous. Injury or death can occur to the operator or bystanders if the product is not used carefully and correctly. To prevent injury to the operator or bystanders, read and obey all safety instructions in the operator's manual.



Use approved eye protection.



Rated voltage, V



Direct current.



Noise emissions to the environment according to European Directive 2000/14/EC and New South Wales legislation "Protection of the Environment Operations (Noise Control) Regulation 2017". Noise emission data can be found on the machine label and in the Technical data chapter.



The product or package of the product is not domestic waste. Recycle it at a recycling station for electrical and electronic equipment.



The product agrees with the applicable EC directives.



Do not use in rain.



The blower operator must ensure that no people or animals come closer than 15 metres. When several operators are working at the same site a safety distance of at least 15 metres must be in effect. The blower can forcibly throw objects that can bounce back. This can result in serious eye injuries if the recommended safety equipment is not used.



yyyy wwxxxx

The rating plate shows serial number. **yyyy** is the production year, **ww** is the production week.

## Manufacturer

Husqvarna AB

Drottninggatan 2, SE-561 82 Huskvarna

## Product liability

As referred to in the product liability laws, we are not liable for damages that our product causes if:

- the product is incorrectly repaired.
- the product is repaired with parts that are not from the manufacturer or not approved by the manufacturer.
- the product has an accessory that is not from the manufacturer or not approved by the manufacturer.
- the product is not repaired at an approved service center or by an approved authority.

---

## Safety

---

### Safety definitions

Warnings, cautions and notes are used to point out specially important parts of the manual.



**WARNING:** Used if there is a risk of injury or death for the operator or bystanders if the

instructions in the manual are not obeyed.



**CAUTION:** Used if there is a risk of damage to the product, other materials or the adjacent area if the instructions in the manual are not obeyed.

---

---

**Note:** Used to give more information that is necessary in a given situation.

---

## Introduction

---



**WARNING:** Read all safety warnings and all instructions. Failure to follow the warnings and instructions may result in electric shock, fire and/or serious injury.

---

### General power tool safety warnings

#### Check before starting

- Inspect the working area. Remove all loose objects, such as stones, broken glass, nails, steel wire, string etc. that could be thrown out.
- Always remove the battery to prevent the machine being started by accident. Always disconnect the battery before any maintenance on the machine.
- Before using the machine and after any impact, check for signs of wear or damage and repair as necessary.
- Only use original spare parts.
- The machine operator must ensure that no people or

animals come closer than 15 metres while working. When several operators are working in the same area the safety distance should be at least 15 metres.

- Do an overall inspection of the machine before use, see maintenance schedule.
- National or local regulations may regulate the use. Comply to given regulations.

### Personal safety

- **Stay alert, watch what you are doing and use common sense when operating a power tool. Do not use a power tool while you are tired or under the influence of drugs, alcohol or medication.** A moment of inattention while operating power tools may result in serious personal injury.
- Keep bystanders away.
- This appliance is not intended for use by person (including children) with reduced physical, sensory or mental capabilities, or lack of experience and knowledge, unless they have been given supervision or instruction concerning use of the appliance by a person responsible for their safety. Children should be supervised

- to ensure that they do not play with the appliance.
- Never allow children or other persons not trained in the use of the machine and/or the battery to use or service it. Local laws may regulate the age of the user.
  - Keep unauthorised persons at a distance. Children, animals, onlookers and helpers should be kept outside the safety zone of 15 m (50 ft.). Stop the machine immediately if anyone approaches.
  - Store the equipment in a lockable area so that it is out of reach of children and unauthorized persons.
  - **Dress properly. Do not wear loose clothing or jewellery. Keep your hair, clothing and gloves away from moving parts.** Loose clothes, jewellery or long hair can be caught in moving parts.
  - Never use the machine if you are tired, if you have drunk alcohol, or if you are taking medication that could affect your vision, your judgement or your coordination.
  - Wear personal protective equipment. See instructions under the heading "Personal protective equipment".
  - Always remove the battery when passing the machine to another person.
  - Keep in mind that it is you, the operator that is responsible for not exposing people or their property to accidents or hazards.

## Power tool use and care

- Never use a machine that has been modified in any way from its original specification. Never use the machine near explosive or flammable materials.
- Never use a machine that is faulty. Carry out the safety checks, maintenance and service instructions described in this manual. Some maintenance and service measures must be carried out by trained and qualified specialists. See instructions under the heading Maintenance.
- Only use original spare parts.
- Always ensure that ventilation openings are kept clear of debris.
- All covers, guards and handles must be fitted before starting.
- Only use the machine in daylight or in other well-lit conditions.

- Never use the machine in bad weather, for instance in fog, in rain, damp or in wet locations, strong winds, intense cold, risk of lightning, etc. Extremely hot weather may cause overheating of the machine. Operation in bad weather is tiring and can lead to dangerous conditions, for instance slippery surfaces.
- If the machine starts vibrating abnormally, stop the machine and remove the battery.
- Walk, never run.

## General safety instructions

---



**WARNING:** Read the warning instructions that follow before you use the product.

---

- Incorrect or careless use of the product can turn it into a dangerous tool that can cause serious or even fatal injury to the operator or others. You must read and understand the contents of this operator's manual.
- Under no circumstances may the design of the product be modified without the permission of the manufacturer. Never use a product that has been

modified in any way from its original specification and always use original accessories. Non-authorized modifications and/or accessories can result in serious personal injury or the death of the operator or others. Your warranty may not cover damage or liability caused by the use of non-authorized accessories or replacement parts.

- This product produces an electromagnetic field during operation. This field may under some circumstances interfere with active or passive medical implants. To reduce the risk of serious or fatal injury, we recommend persons with medical implants to consult their physician and the medical implant manufacturer before operating this product.
- Remove the battery from the product during charging.

## Safety instructions for operation

---



**WARNING:** Read the warning instructions that follow before you use the product.

---

- If you encounter a situation where you are uncertain how

to proceed you should ask an expert. Contact your dealer or your service workshop. Avoid all usage which you consider to be beyond your capability.

- Make sure that you can move and stand safely. Check the area around you for possible obstacles (roots, rocks, branches, ditches, etcetera) in case you have to move suddenly. Take great care when you work on sloping ground.
- Keep a good balance and a firm foothold at all times. Do not overreach.
- Listen out for warning signals or shouts when you wear hearing protection. Always remove your hearing protection as soon as the product stops.
- Do not operate the product near open windows.
- Show consideration to persons in your surroundings by avoiding using the product at unsuitable times, such as late in the evening or early in the morning. Follow local regulations and ordinances.
- Use the product with the lowest possible airflow. It is seldom necessary to use full airflow, and many work procedures can be done at half airflow. A lower airflow means less noise and less dust, and it is also easier to keep control over the rubbish collected together/moved.
- In dusty conditions slightly dampen the surface when using the product.
- Use a rake or a brush to release rubbish stuck to the ground.
- Hold the opening of the blower as close to the ground as possible.
- Observe your surroundings. Direct the product away from persons, animals, play areas, cars etc..
- Minimize the blowing time by lightly wetting dusty areas or using spray equipment.
- Be aware of the wind direction. Work with the wind to make your work easier.
- Stop the product and remove the battery if the product starts to vibrate abnormally.
- Using the blower to move large piles is time consuming and creates unnecessary noise.

- Clean up afterwards. Make sure that you have not blown rubbish into someone's garden.
- Do not run with the product.
- The powerful currents of air can move objects at such a speed that they can bounce back and cause serious eye injuries.

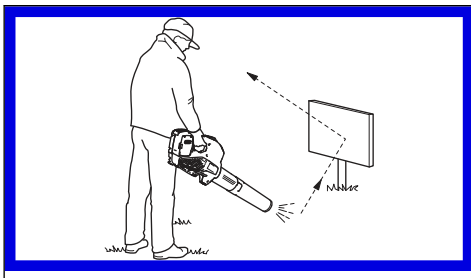

- Do not direct the airflow towards people or animals.
- Stop the motor before you assemble or dismantle accessories or other parts.
- Keep all parts of your body away from hot surfaces.
- Never put the product down when it is activated unless you have it in clear sight.

- The blower must not be used while on a ladder or scaffolding.



- Do not use the product unless you are able to call for help in case of an accident.
- Watch out for thrown objects. Stones, rubbish, etc., can be thrown up into the eyes causing blindness or serious injury.
- Use a residual-current device (RCI) for increased security when you charge the product. A residual-current device is fitted to protect operators in case an electrical fault should occur.
- This product is renowned for its low vibration load. Overexposure to vibration can lead to circulatory damage or nerve damage in people who have impaired circulation. Contact your doctor if you experience symptoms of overexposure to vibration.

Such symptoms include numbness, loss of feeling, tingling, pricking, pain, loss of strength, changes in skin colour or condition. These symptoms normally appear in the fingers, hands or wrists.

- Only use the product for the purpose it was intended for.
- It is not possible to cover every conceivable situation you can face. Always exercise care and use your common sense. Avoid all situations which you consider to be beyond your capability. If you still feel uncertain about operating procedures after reading these instructions, you should consult an expert before continuing.

## Personal protective equipment



**WARNING:** Read the warning instructions that follow before you use the product.

- Always use approved personal protective equipment when you use the product. Personal protective equipment cannot fully prevent injury but it decreases the degree of injury if an accident does occur. Let

your dealer help you select the right equipment.

- Long term exposure to noise can result in damaged hearing. In general, battery powered products are relatively quiet but damage can result from a combination of noise level and long usage. recommends that operators use hearing protectors when using products for a longer coherent time of a day. Continual and regular users should have their hearing checked regularly. Note that hearing protectors limit the ability to hear sounds and warning signals.

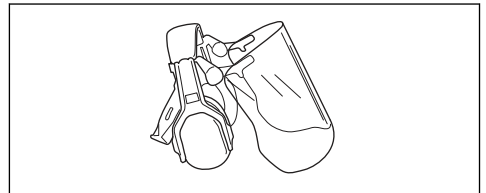

- Use approved eye protection. If you use a visor, you must also use approved protective goggles. Approved protective goggles must comply with the ANSI Z87.1 standard in the

USAs or EN 166 in EU countries.

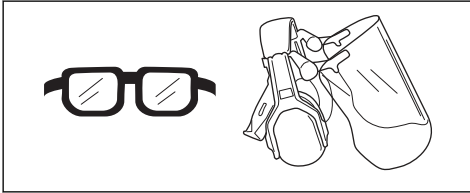

- Use clothing made of a strong fabric. Always use heavy, long pants and long sleeves. Do not use loose clothing that can catch on twigs and branches. Do not wear jewelry, short pants, sandals or go with bare feet. Put your hair up safely above shoulder level.
- Keep first aid equipment close at hand.



- A breathing mask should be used when there is a risk of dust.

## Safety devices on the product

---



**WARNING:** Read the warning instructions that follow before you use the product.

---

- In this section the product's safety features, its purpose

and how checks and maintenance should be carried out to ensure that it operates correctly. See instructions under the heading *Product overview on page 2* to find where these parts are located on your product.

- The life span of the product can be reduced and the risk of accidents can increase if product maintenance is not carried out correctly and if service and/or repairs are not carried out professionally. If you need further information please contact your nearest servicing dealer.
- Never use a product with defective safety components. The product's safety equipment must be inspected and maintained as described in this section. If your product fails any of these checks, contact your service agent to get it repaired.
- All servicing and repair work on the product requires special training. This is especially true of the product's safety equipment. If your product fails any of the checks described below you must contact your service agent. When you buy any of our products we guarantee the availability of

professional repairs and service. If the retailer who sells your product is not a servicing dealer, ask him for the address of your nearest service agent.

### To do a check of the keypad

1. Push and hold the start/stop button (B).

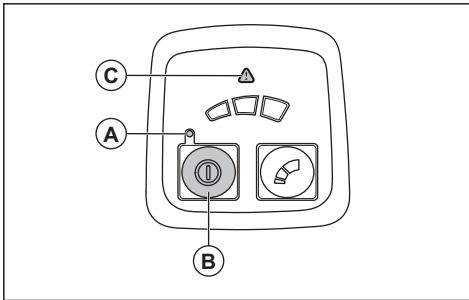

- a) The product is on when the LED (A) comes on.
- b) The product is off when the LED (A) is out.

2. Refer to *User interface on page 17* if the warning indicator (C) comes on or flashes.

### To do a check of the power trigger

- Push and release the power trigger to make sure that it moves freely.

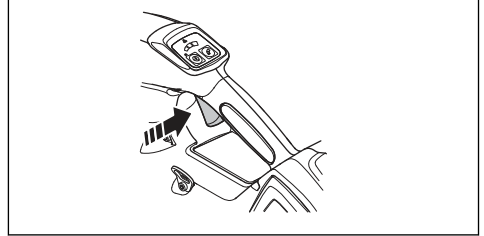

### Battery safety



**WARNING:** Read the warning instructions that follow before you use the product.

- Only use the BLi batteries that we recommend for your product. The batteries are software encrypted.
- Use the BLi batteries that are rechargeable as a power supply for the related Husqvarna products only. To prevent injury, do not use the battery as a power supply for other devices.
- Risk of electrical shock. Do not connect the battery terminals to keys, screws or other metal. This can cause a short circuit of the battery.

- Do not use batteries that are non-rechargeable.
- Do not put objects into the air slots of the battery.
- Keep the battery away from sunlight, heat or open flame. The battery can cause burns and/or chemical burns.
- Keep the battery away from rain and wet conditions.
- Keep the battery away from microwaves and high pressure.
- Do not try to disassemble or break the battery.
- Use the battery in temperatures between -10 °C (14 °F) and 40 °C (104 °F).
- Do not clean the battery or the battery charger with water. Refer to *To clean the product, the battery and the battery charger on page 16*.
- Do not use a defective or damaged battery.
- Keep batteries in storage away from metal objects such as nails, screws or jewelry.
- Keep the battery away from children.
- Risk of electrical shock or short circuit if the safety instructions are not obeyed.
- Do not use other battery chargers than the one supplied for your product. Only use Husqvarna QC chargers when you charge BLi replacement batteries.
- Do not try to disassemble the battery charger.
- Do not use a defective or damaged battery charger.
- Do not lift the battery charger by the power cord. To disconnect the battery charger from a mains socket, pull out the plug. Do not pull the power cord.
- Keep all cables and extension leads away from water, oil and sharp edges. Make sure that the cable is not caught between objects, for example, doors, fences or equivalent.
- Do not use the battery charger near flammable materials or materials that can cause corrosion. Make sure that the battery charger is not covered. Pull out the plug to the battery charger if there is smoke or fire.
- Only charge the battery indoors in a location with good airflow and away from sunlight. Do not charge the

## Battery charger safety

---



**WARNING:** Read the warning instructions that follow before you use the product.

---

battery outdoors. Do not charge the battery in wet conditions.

- Only use the battery charger where the temperature is between 5 °C (41 °F) and 40 °C (104 °F). Use the charger in an environment which has a good airflow, dry and free from dust.
- Do not put objects into the cooling slots of the battery charger.
- Do not connect the battery charger terminals to metal objects as this can short circuit the battery charger.
- Use approved mains sockets that are not damaged. Make sure that the cord of the battery charger is not damaged. If extension cables are used, make sure that the extension cables are not damaged.

## Safety instructions for maintenance



**WARNING:** Read the warning instructions that follow before you do maintenance on the product.

---

- Remove the battery before you do maintenance, other

checks or assemble the product.

- The operator must only do the maintenance and servicing shown in this operator's manual. Speak to your servicing dealer for maintenance and servicing of a larger extension.
- Keep all nuts, bolts and screws tight to be sure the product is in safe working condition.
- Replace worn or damaged parts.
- If you do not do maintenance, it decreases the life cycle of the product and increases the risk of accidents.
- Special training is necessary for all servicing and repair work, especially for the safety devices on the product. If not all checks in this operator's manual are approved after maintenance, speak to your servicing dealer. We guarantee that there are professional repairs and servicing available for your product.
- Only use original spare parts.

---

## Assembly

---

### Introduction



**WARNING:** Read and understand the safety chapter before you assemble the product.

### To assemble the tube on the product

1. Put the blower nozzle over the tubular end of the product.

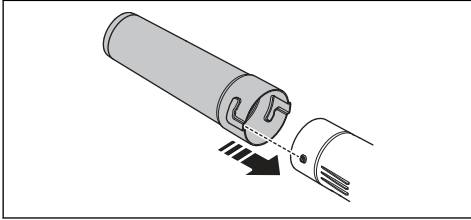

2. Push the blower nozzle in fully and turn the blower nozzle to lock it to the product.

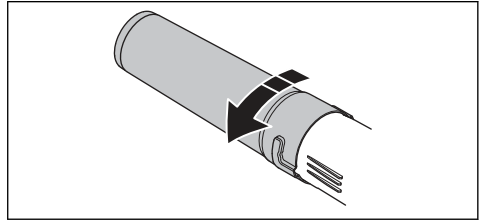

---

## Operation

---

### Introduction



**WARNING:** Read and understand the safety chapter before you use the product.

### To do a function check before you use the product

1. Do a check of the air inlet for dirt and cracks. Use a brush and clean off grass and leaves from the product.
2. Make sure that the product works correctly.
3. Do a check of all nuts and screws and make sure that they are tight.

### To connect the battery charger

1. Connect the battery charger to the voltage and frequency that is specified on the rating plate.
2. Put the plug in a grounded socket outlet. The LED on the battery charger flashes green one time.

**Note:** The battery does not charge if the battery temperature is more than 50 °C/122 °F. If the temperature is more than 50 °C/122 °F, the battery charger makes the battery become cool before the battery charges.

### To charge the battery

**Note:** Charge the battery if it is the first time that you use it. A new battery is only 30% charged.

1. Connect the battery to the battery charger.

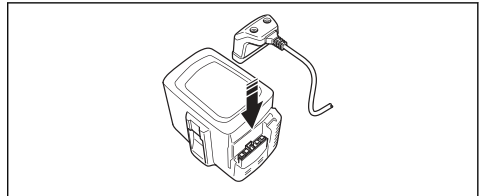

2. Make sure that the green charging light on the battery charger comes on. That means that the battery is connected correctly to the battery charger.

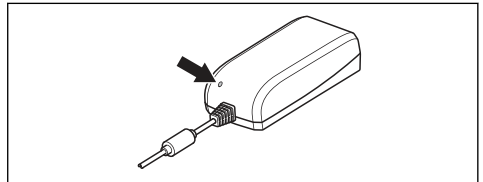

- When all LEDs on the battery come on, the battery is fully charged.

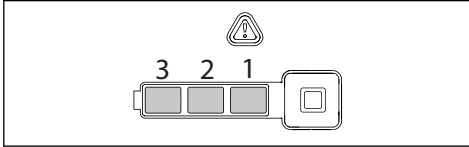

- To disconnect the battery charger from the mains socket, pull the plug. Do not pull the cable.
- Disconnect the battery from the battery charger.

**Note:** Refer to the battery and battery charger manuals for more information.

## To connect the battery to the product



**WARNING:** Only use Husqvarna original batteries in the product.

- Make sure that the battery is fully charged.
- Slide the battery into the battery holder of the product. The battery must slide easily, if not, it is not installed correctly.

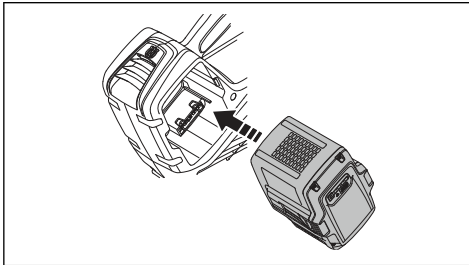

- Press the lower part of the battery and push it in as far as it will go into the battery compartment. The battery will lock into position when you hear a click.
- Make sure that the latches snap in place correctly.

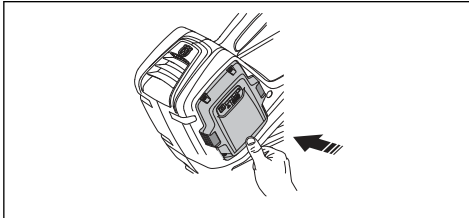

## To start the product

- Push and hold the start button until the green LED light comes on.

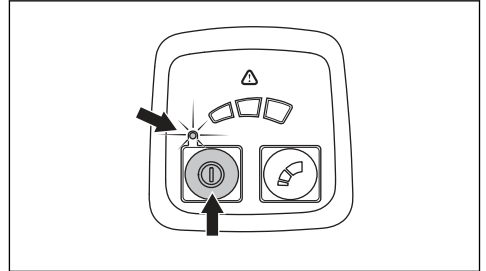

- Use the power trigger to operate the product.

## To set the optimal airflow for your work

- Push the mode control button to set the airflow. There are 3 airflow steps. The LED shows the set airflow.

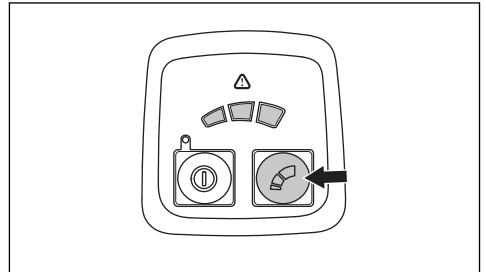

## To stop the product

- Release the power trigger.
- Push and hold the stop button until the green LED light comes off.
- Remove the battery from the product. Push the two release buttons and pull out the battery.

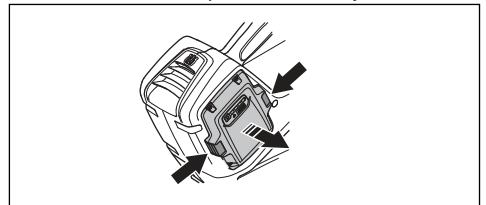

## Automatic shutdown function

The product has an automatic shutdown function that stops the product if it is not used. The product shuts down after 30 minutes.

# Maintenance

## Introduction



**WARNING:** Before you do any maintenance work you must read and understand the safety chapter.

## Maintenance schedule



**WARNING:** Remove the battery before you do maintenance.

The following is a list of the maintenance steps that you must do on the product.

Maintenance	Daily	Weekly	Monthly
Clean the outside of the machine with a clean and dry cloth. Never use water.	X		
Keep handles dry, clean and free from oil and grease.	X		
Make sure that the start/stop button works correctly and is not damaged.	X		
Make sure the power trigger is functioning properly with regard to safety.	X		
Check that nuts and screws are tight.	X		
Check that the battery is intact.	X		
Check the battery's charge.	X		
Check that the release buttons on the battery works and locks the battery into the machine.	X		
Check that the battery charger is intact and functional.	X		
Check that all couplings, connections and cables are intact and free from dirt.		X	
Check the connections between the battery and the machine and also check the connection between battery and the battery charger.			X

## To do a check of the air intake

1. Make sure that the air intake is not blocked on the sides on the product.

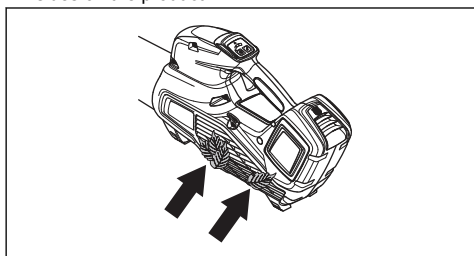

2. Stop the product and remove leaves or unwanted material if it is necessary.



**CAUTION:** A blocked air intake decreases the blow capacity of the product and increases the work temperature of the motor. This can result

in motor failure because the motor becomes too hot.

## To examine the battery and the battery charger

1. Examine the battery for damages, for example cracks.
2. Examine the battery charger for damages, for example cracks.
3. Make sure that the connection cord of the battery charger is not damaged and that there are no cracks in it.

## To clean the product, the battery and the battery charger

1. Clean the product with a dry cloth after use.
2. Clean the battery and battery charger with a dry cloth. Keep the battery guide tracks clean.
3. Make sure that the terminals on the battery and the battery charger are clean before the battery is put in the battery charger or the product.

# Troubleshooting

## User interface

User interface	Possible faults	Possible solution
Green LED Flashes	Low battery voltage.	Charge the battery.
Red error LED flashes	Temperature deviation.	Let the product cool down.
The product does not start	Dirt in battery connectors.	Clean with compressed air or a soft brush.
	The battery is empty.	Charge the battery.
Red error LED flashes	Servicing is necessary.	Speak to your servicing agent.

## Battery

LED display	Possible faults	Possible action
Green LED flashing	Low battery voltage.	Charge the battery.
Red error LED flashing	The battery is discharged.	Charge the battery.
	Temperature deviation.	Use the battery in temperatures between -10°C (14°F) and 40°C (104°F).
	Over voltage.	Check that the mains voltage corresponds with that stated on the rating plate on the product.
Remove the battery from the battery charger.		
Red error LED is lit	Cell difference is too much (1V).	Contact your servicing agent.

## Battery charger

Problem	Possible faults	Possible solution
Red error LED flashes.	Temperature deviation.	Use the battery charger in temperatures between 5 °C (41 °F) and 40 °C (104 °F).
Red error LED comes on.		Speak to your servicing dealer.

---

## Transportation, storage and disposal

---

### Transportation and storage

- The supplied Li-ion batteries obey the Dangerous Goods Legislation requirements.
- Obey the special requirement on package and labels for commercial transportation, including by third parties and forwarding agents.
- Speak to a person with special training in dangerous material before you send the product. Obey all applicable national regulations.
- Use tape on open contacts when you put the battery in a package. Put the battery in the package tightly to prevent movement.
- Remove the battery for storage or transportation.
- Put the battery and the battery charger in a space that is dry and free from moisture and frost.
- Do not keep the battery in an area where static electricity can occur. Do not keep the battery in a metal box.
- Put the battery in storage where the temperature is between 5°C/41°F and 25°C/77°F and away from open sunlight.
- Put the battery charger in storage where the temperature is between 5 °C/41 °F and 45°C/113°F and away from open sunlight.
- Use the battery charger only when the surrounding temperature is between 5°C/41°F and 40°C/104°F.
- Charge the battery 30% to 50% before you put it in storage for long periods.

- Put the battery charger in storage in a space that is closed and dry.
- Keep the battery away from the battery charger during storage. Do not let children and other not approved persons to touch the equipment. Keep the equipment in a space that you can lock.
- Clean the product and do a full servicing before you put the product in storage for a long time.
- Use the transportation guard on the product to prevent injuries or damage on the product during transportation and storage.
- Attach the product safely during transportation.

### Disposal of the battery, battery charger and product

The symbol below means that the product is not domestic waste. Recycle it at a recycling station for electrical and electronic equipment. This helps to prevent damage to the environment and to persons.

Speak to local authorities, domestic waste service or your dealer for more information.

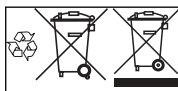

**Note:** The symbol shows on the product or package of the product.

---

---

## Technical data

---

### Technical data

	<b>120iB</b>
<b>Motor</b>	
Motor type	BLDC (brushless) 36V
<b>Weight</b>	
Weight without battery, kg	2.0
<b>Noise emissions<sup>1</sup></b>	
Sound power level, measured dB (A)	96
Sound power level, guaranteed L <sub>WA</sub> dB (A)	97

<sup>1</sup> Noise emissions in the environment measured as sound power (L<sub>WA</sub>) in conformity with EC directive 2000/14/EC. Reported sound power level for the machine has been measured with the original cutting attachment that gives the highest level. The difference between guaranteed and measured sound power is that the guaranteed sound power also includes dispersion in the measurement result and the variations between different machines of the same model according to Directive 2000/14/EC.

	<b>120iB</b>
<b>Water protection level</b>	
All weather use	Yes
IPX4 <sup>2</sup>	No
<b>Sound levels<sup>3</sup></b>	
Equivalent sound pressure level at the operator's ear, measured according to EN ISO 11203 and ISO 22868, dB (A):	83
<b>Vibration levels<sup>4</sup></b>	
Vibrations levels at handles, measured according to ISO 22867, m/s <sup>2</sup>	1.0
<b>Fan performance</b>	
Air flow in normal mode with standard nozzle, m <sup>3</sup> /min	10.3
Maximum air velocity in normal mode with standard nozzle, m/s / mph	46 / 102.9

Noise and vibration data are determined on the basis of the rated maximum speed.

### Approved batteries

**Only use Husqvarna original BLI batteries for this product.**

### Approved batteries

Battery	BLi10		BLi20	
	Lithium-ion		Lithium-ion	
Battery capacity, Ah	2.1 (VTC4)	2 (HD2)	4.2 (VTC4)	4.0 (HD2)
Nominal voltage, V	36	36.5	36	36.5
Weight, kg/lbs	0.7/1.5	0.7/1.5	1.2/2.6	1.2/2.6

### Approved battery chargers

Battery charger	QC 80
Input voltage, V	100-240
Frequency, Hz	50-60
Power, W	80

<sup>2</sup> The Husqvarna Handheld Battery products marked with IPX4 fulfils these requirements on product approval level

<sup>3</sup> Reported data for equivalent sound pressure level for the machine has a typical statistical dispersion (standard deviation) of 3 dB (A).

<sup>4</sup> Reported data for vibration level has a typical statistical dispersion (standard deviation) of 2 m/s<sup>2</sup>.

---

# EC Declaration of Conformity

---

## EC Declaration of conformity

Husqvarna AB, SE-561 82 Huskvarna, Sweden, tel: tel: +46-36-146500, declares under sole responsibility that the battery leaf blowers **Husqvarna 120iB** and **Husqvarna120iB packed together with battery and charger**, from 2019's serial number and onwards (the year is clearly stated in plain text on the type plate with subsequent serial number), are in conformity with the requirements of the COUNCIL'S DIRECTIVES:

- of May 17, 2006 "relating to machinery" **2006/42/EC**.
- of February 26, 2014 "relating to electromagnetic compatibility" **2014/30/EU**.
- of May 8, 2000 "relating to the noise emissions in the environment" **2000/14/EC**.
- of June 8, 2011 on the "restriction of use of certain hazardous substances" **2011/65/EU**

The following standards have been applied.

**Husqvarna 120iB**: EN 60335-1:2012 (IEC 60335-2-100:2002), EN 61000-6-3:2007+A1:2011, EN 61000-6-1:2016, EN 50581:2012

**Charger** (also placed on market as a standalone product 2014): EN 60335-2-29, EN 55014-1:2006+A1:2009+A2:2011, EN 55014-2:1997+A1:2001+A2:2008, EN61000-3-2:2006+A1:2009+A2:2009, EN61000-3-3:2013, EN 50581:2012

**Battery** (also place on market as a standalone product 2016): EN 62133:2013, EN 61000-6-3:2007+A1:2011, EN 61000-6-1:2016, EN 50581:2012

RISE SMP Svensk Maskinprovning AB, Box 7035, SE-750 07 Uppsala, Sweden, has certified conformity with annex V of the Council's Directive of May 8, 2000 "relating to the noise emissions in the environment" 2000/14/EC. The certificates has the number: 01/012/016.

For information relating to noise emissions, refer to *Technical data on page 18*.

In addition, RISE SMP Svensk Maskinprovning AB, Box 7035, SE-750 07 Uppsala, Sweden, has carried out a voluntary type examination on behalf of Husqvarna AB. The certificate has the number: SEC/19/2541.

For information relating to noise emissions, refer to *Technical data on page 18*.

Huskvarna, 2020-01-10



Pär Martinsson, Development manager (Authorized representative for Husqvarna AB and responsible for technical documentation.)









[www.husqvarna.com](http://www.husqvarna.com)

Original instructions

1141267-26



2020-01-08