



INSTALLATION MANUAL

1200R

ECONomy Shower

30 Day Technical Support:

Call **01908 317512** and request technical support for aiding your installation.

Replacements Parts:

 Inside of your warranty period visit:

<https://www.insigniashowers.com>, click support and make a warranty claim.

Spares/Replacements Parts:

 Outside of your warranty period visit

<https://www.insigniashowers.com/replacement-parts.html>



ATTENTION INSTALLERS:

These instructions must be left with the customer

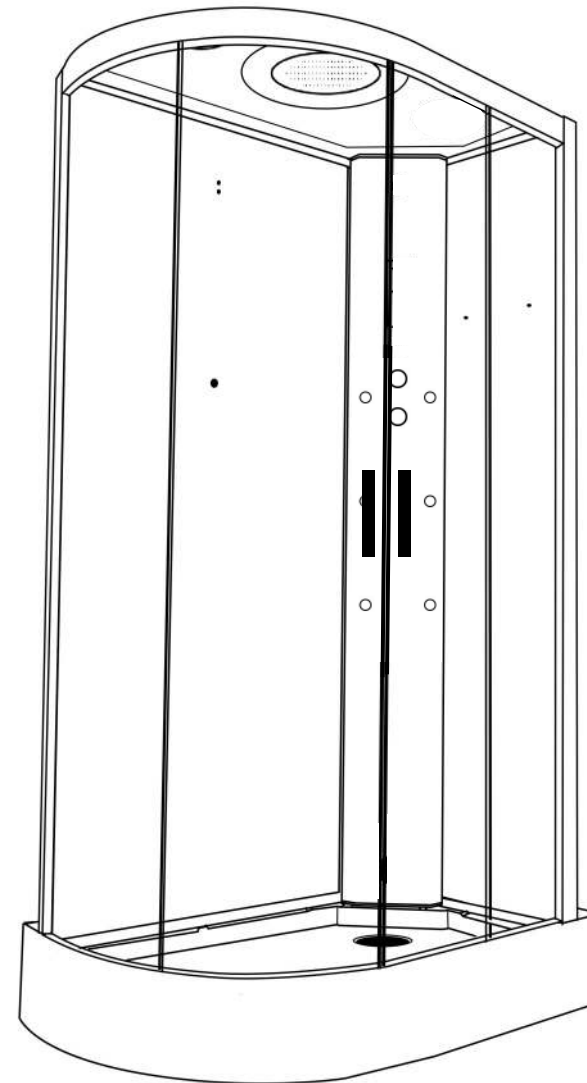

CHECK ALL CONTENTS BEFORE BUILD COMMENCES. NO RETURNS CAN BE MADE ONCE THE BUILD HAS STARTED AS IT IS DEEMED ACCEPTANCE OF PRODUCT!

WARRANTY REG NO: _____

To claim your full 5 year warranty, register your shower within 90 days visit:

<https://www.insigniashowers.com>, click support and register for your warranty

Contents

Installation Assistance (Video Links)	3
Thank you for your purchase	4
Tips for assembly	5
Braided Hose QR Code/Link	6
Pressure/Tool requirements	7
Box contents	8
Installing the Waste and Levelling the Tray	9
Connecting the Framework	10
Applying RubberGum	11
Installing the Back Panels	12
Installing the Column	13
Installing the Fixed Glass Panels	14

Installing the Glass Seals	15
Installing the Roof	16
Installing the Door Wheels	17
Installing the Accessories	18
Water Valve Connections	19
Signing off your shower	20
Spare Parts List	21
Steam Room & Shower Safety Guide	22
WEEE Compliance Statement	23

Installation Assistance

Looking for assistance with the Install?

GREAT NEWS!

We have our easy to follow Installation videos live online NOW to make your installation process easier than ever before!

Simply click the link below and watch the installation process.

[**Shower Cabin**](#)

Please note: this build video is for an Insignia Platinum Shower, however 90% of the process is the same for assembly so it should help you on your way!



Thank you for your recent purchase of an Insignia shower. Please read this booklet with great care to ensure you get the best out of your build and have a shower that will last for many years to come! Like everything, in order to obtain a first class product that will serve you well for many years, the effort and correctness put into the assembly will reflect in the quality of your finish.

Before we start, here's our 4 top tips which may assist you...

TIP 1—Building Your Shower

This product is suitable for a DIY build, providing you are confident in your DIY abilities. Please look through this build guide and decide on whether you feel confident in undertaking this task. If you are not, seek the services of a professional and show them these instructions before hiring.

TIP 2—Hard Water

Due to the nature of this product we highly advise the purchase and fitting of a water softener.
(Please note: limescale build up may cause damage to your shower and will not be covered under warranty)

TIP 3—Installation

These showers are designed to be free standing and movable from their location should you have the need to replace anything. **ALWAYS USE** Flexible braided water inlet pipes (not supplied) and not central heating plastic type! Get your WRAS Approved Flexible Braided Hoses [here](http://www.insigniashowers.com/wras-approved-braided-hoses.html). (www.insigniashowers.com/wras-approved-braided-hoses.html)

NEVER FIX with rigid pipes, **NEVER FIX** the unit to the wall or floor.

TIP 4—Sealing

When using Insignia's RubberGum, please ensure the product does not come in contact with your silicone as this will cause the RubberGum to fail and will not adhere as intended. RubberGum is immediately waterproof and will gain additional strength over time.

Have you got yours?

Essential for your shower build!

The Insignia **WRAS** approved flexible braided shower hose is an essential part of your shower build. Designed specifically for connecting the hot and cold water feeds allowing for an easier installation. **Note: These are not available in shops.**

Don't worry if you have forgotten to purchase this as we've included this handy link for you! All you need to do is use your smart device and simply point your camera at the QR code to scan it. You can also download a free QR reader app.



Not got a smart device? No problem! Just type the following web link into your web browser:

www.insigniashowers.com/wras-approved-braided-hoses.html



Essential
Item

Pressure/Water Requirements

We recommend a BAR pressure between 2.5 and 3.4 BAR. If you have a combi boiler system no problem should be experienced. If you have a gravity feed older type installation (hot water tank type usually less than 1 BAR) you will almost certainly need a pump. We cannot advise on which type of pump is used, location or design because all house plumbing layouts vary. This is a job for your installer/plumber. The end delivery however must fall within the scope above.

Important Note Do not exceed 3.4 BAR pressure under any circumstances. Warranty is void if so as damage will occur. If you have a combi supply, please use a pressure reducing valve if required to lower the BAR pressure to the shower.

Please Remember that this product is free standing and is designed to be pulled away from the wall.

Waste connection HOUSE to SHOWER.

Always use a McAlpine or similar approved 40mm compression joint fitting. Never use glued joints!

Your waste hose is specifically designed not to accept glued joint fittings.

Correct compression joint fittings avoid degradation of materials.

The water supply pipes must be that of a flexible braided type **(not supplied)**.

DO NOT OVERTIGHTEN THE BRAIDED HOSES AS IT CAN CAUSE THE CONNECTION TO POP AFTER A FEW WEEKS OF USE.

Always fit easy to get to isolation taps on both hot and cold water supply (not supplied). Just like a dishwasher or washing machine, this product **MUST** be isolated when not in use.

Tools Required

You will require:

- | | |
|---|--|
| <ul style="list-style-type: none"> • Scissors • Knife • Spirit Level • Tape Measure | <ul style="list-style-type: none"> • Philips Screwdriver • Electric Drill • Safety Gloves • Safety Glasses |
|---|--|

Parts Required

- RubberGum (supplied)
- Plumbers Mait (not supplied)
- Hot and cold isolation valves (not supplied)
- Suitable McAlpine or similar approved 40mm compression joint fitting.
- 2x Braided hoses (not supplied) Steam version requires 3. If you haven't purchased these already, simply click the following link below or copy in to any web browser. For ease we have listed the required pack below for your install.
- Shower cabins require **pack 1**

<https://www.insigniashowers.com/wras-approved-braided-hoses.html>

What's in the Boxes?

Box	Contents	Quantity	✓
Tray	Shower Tray	1	[]
	Waste + Hose	1	[]
	Glass Shelf	1	[]
	Riser Rail for hand shower	1	[]
	Screw Pack	1	[]
	Flexible seal (12mm)	1	[]
	Flexible seal (7mm)	1	[]
	Shower hose	1	[]
Glass Room	Glass Doors	2	[]
	Front Fixed Glass	2	[]
Column	Complete Column	1	[]
	Hand Shower	1	[]
Backwalls	Left Back Panel	1	[]
	Right Back Panel	1	[]

Framework	Top Rail	1	[]
	Bottom Rail	1	[]
	Outer Fixed Uprights	2	[]
	Magnetic door seals	2	[]
	Rear flap door seals	2	[]
	Framework Securing Clips	4	[]
Roof	Roof with fittings	1	[]

Screw Pack Contents

Product Code	Description	Quantity
SP097	Door Handles	2
SP276	Twin Door Wheels Non-Push	4
SP276A	Twin Door Wheels Push button	4
SP072	Door stops	8
ST10	10mm Screws	8
ST16	16mm Screws	28
ST20 or WN20	20mm Nut and Bolt or Wing Nut	12
PRC20	Glass Retaining Clips	4
SW9	Small Metal Washers	32
DB9	Drill Piece	1

VERY IMPORTANT

Have you got everything? If not please contact the Insignia directly on **01908 317 512**. Remember **NEVER** book your tradesman until everything has arrived, been checked and is present. No replacement/missing parts can be obtained free of charge during or after the build. Any claims can only be within the timescale permitted (48 hours after delivery) and always **BEFORE** build.

Step 1 — Level the Tray and connecting the waste

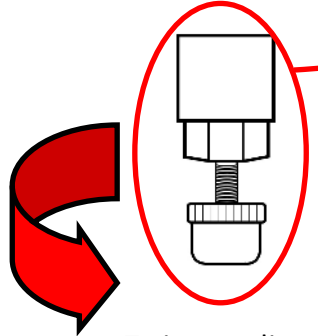
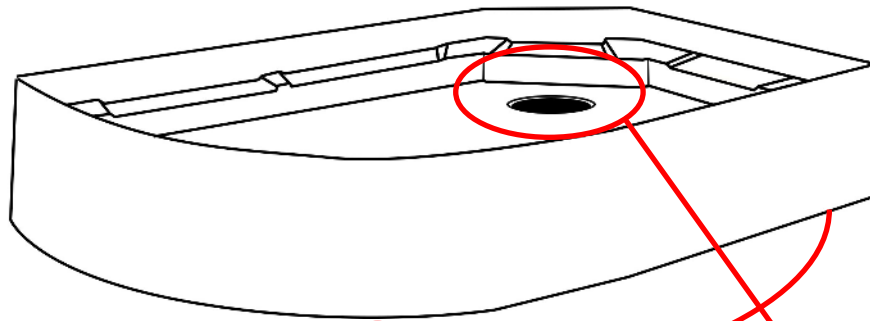

Twist to adjust

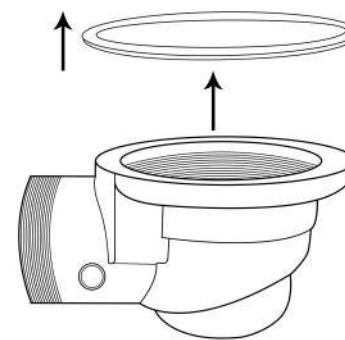
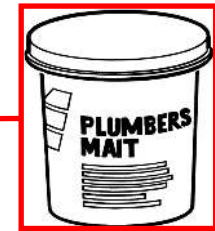
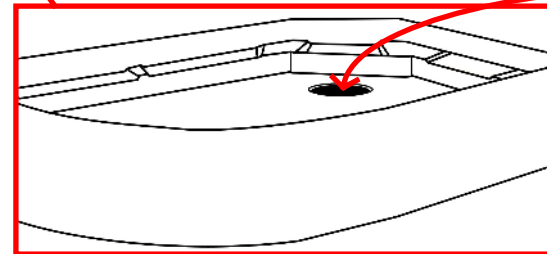
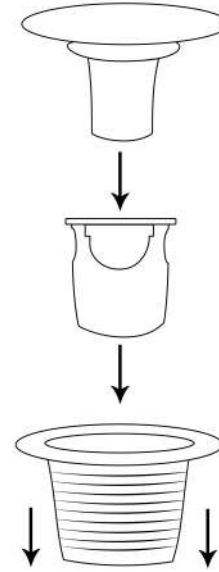

Waste connection HOUSE to SHOWER.

Always use a McAlpine or similar approved 40mm compression joint fitting. Never use glued joints!

Your waste hose is specifically designed not to accept glued joint fittings.

Correct compression joint fittings avoid degradation of materials.

Step 2 — Connecting framework

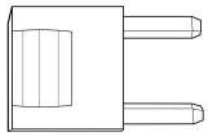

Framework securing clips x4

Wider rail on top

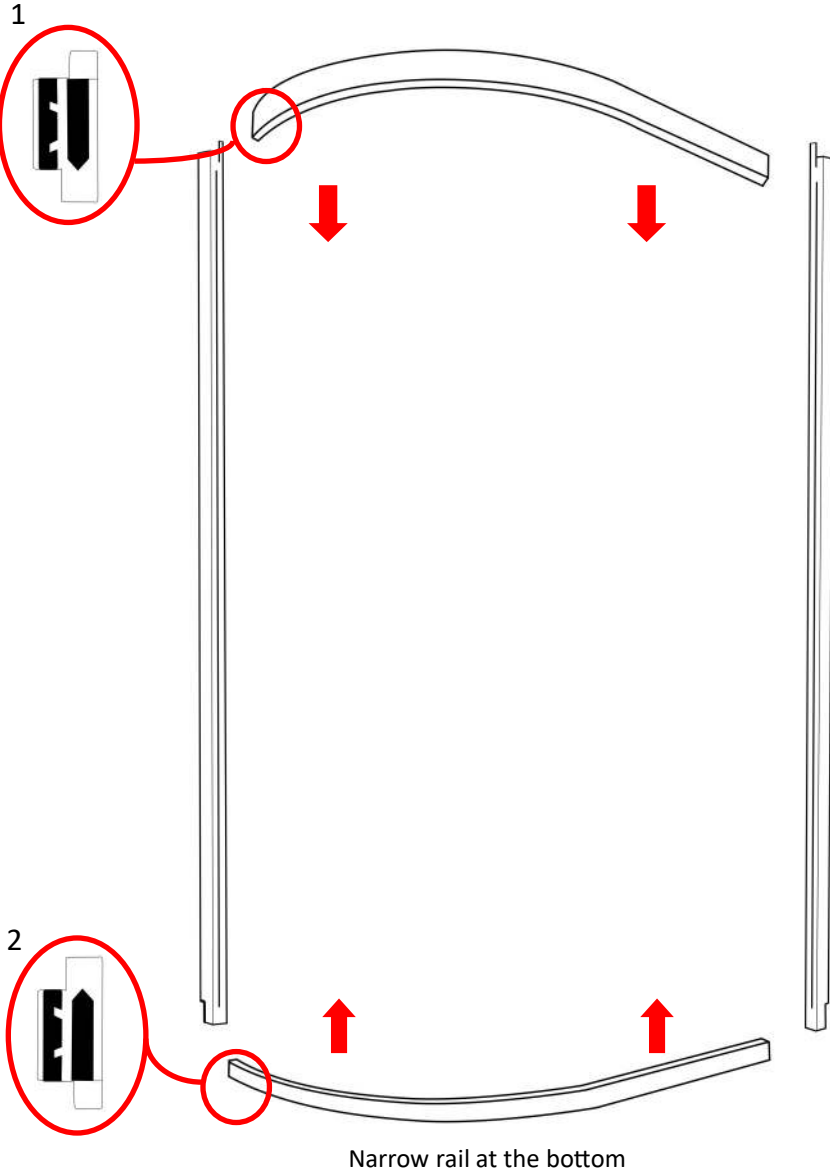

Internal View

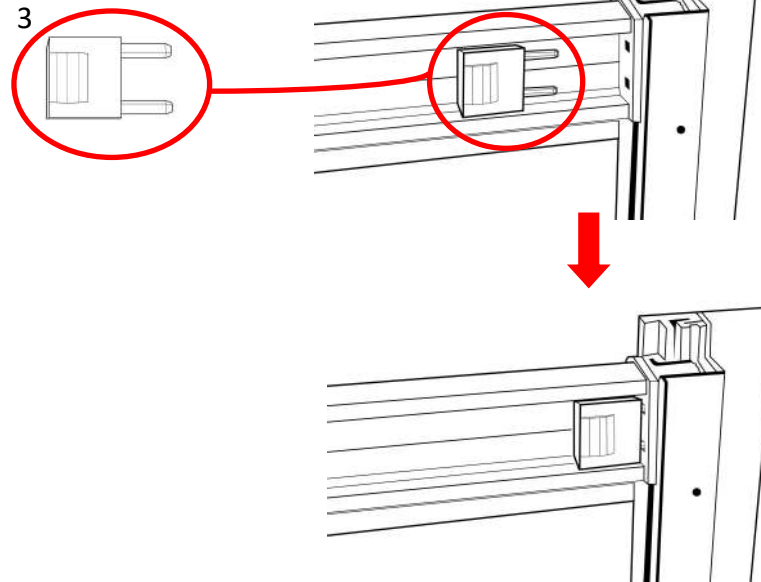

Step 3 — RubberGum the tray

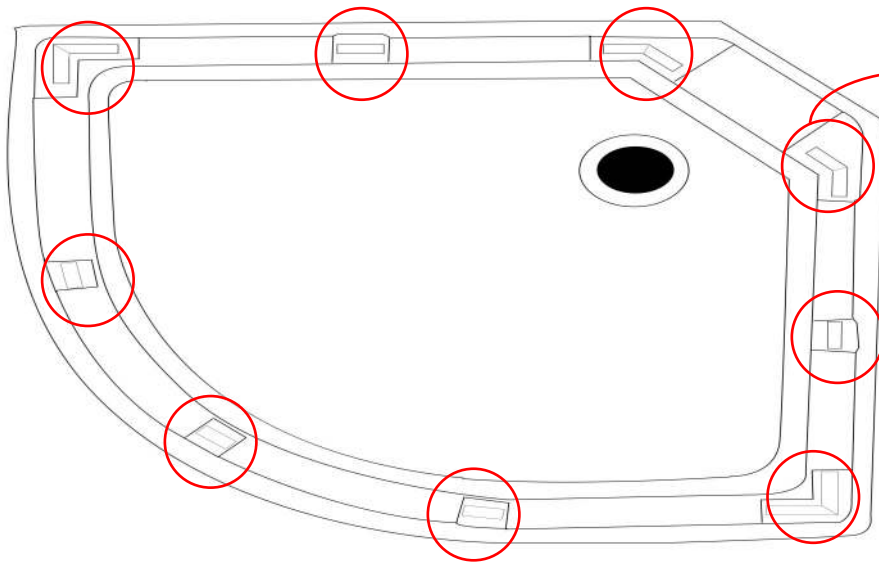

Apply RubberGum to raised sections of the tray and remove backing paper.

A photograph of the RubberGum product packaging, which is a black box with white and red text, and a roll of white adhesive tape.

Step 4 — Fix framework to the tray

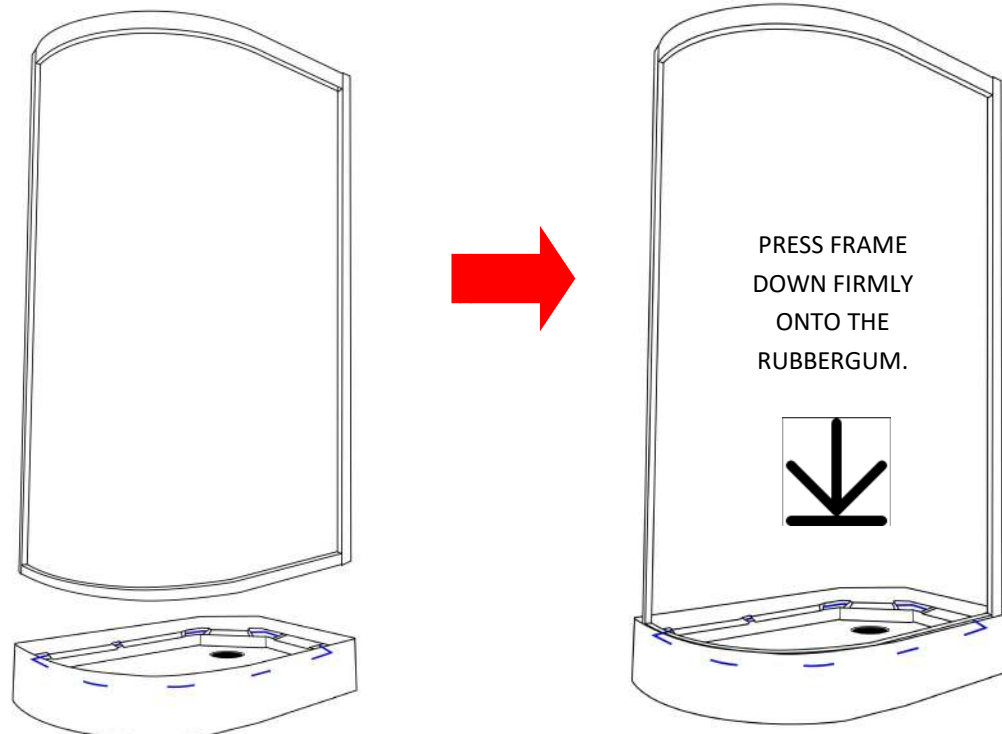

Please Note 2nd Generation showers lower profile curve is not designed to fully follow the tray curve. Gap to tray being wider at each end.

Step 5 — Connecting the back panels

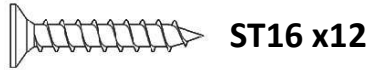

SW9 x 12

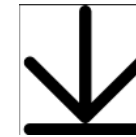
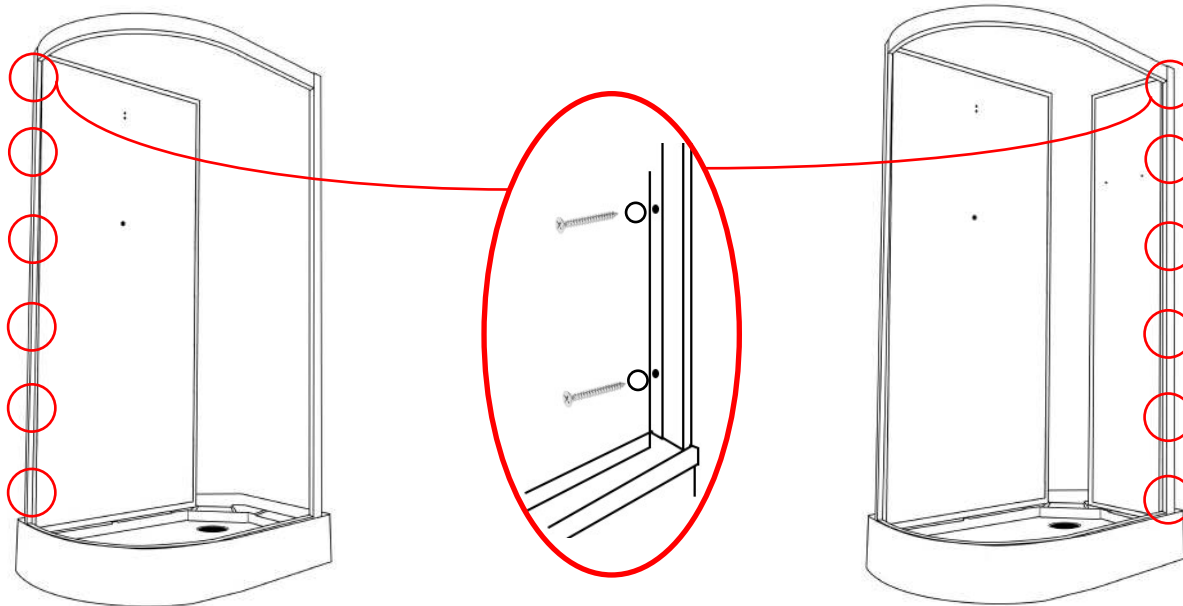

PRESS PANELS
DOWN FIRMLY
ON TO THE
RUBBERGUM.



DO NOT SCREW BACK PANELS TO THE TRAY.

Step 6 — Column Connection

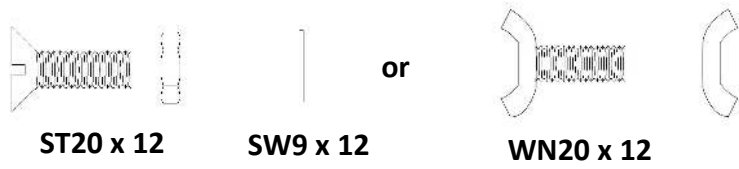

Rear View (attach nuts and bolts or wing nuts from rear)

Below diagram shows the nut/bolt install

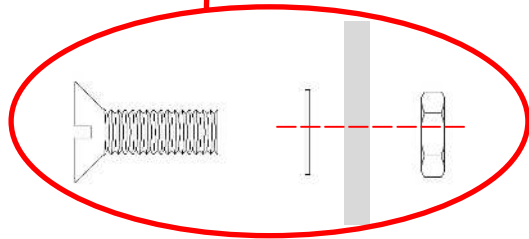
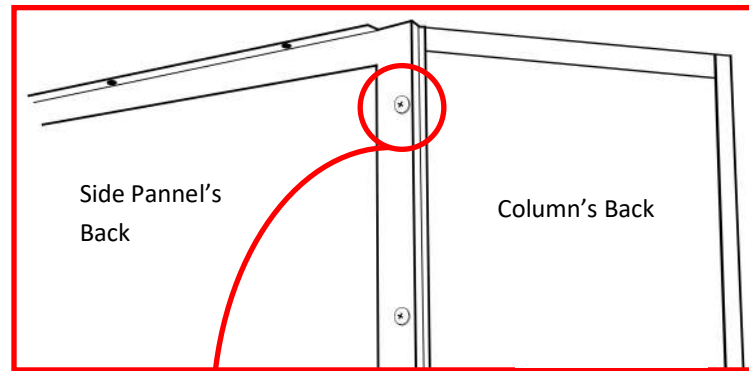

or

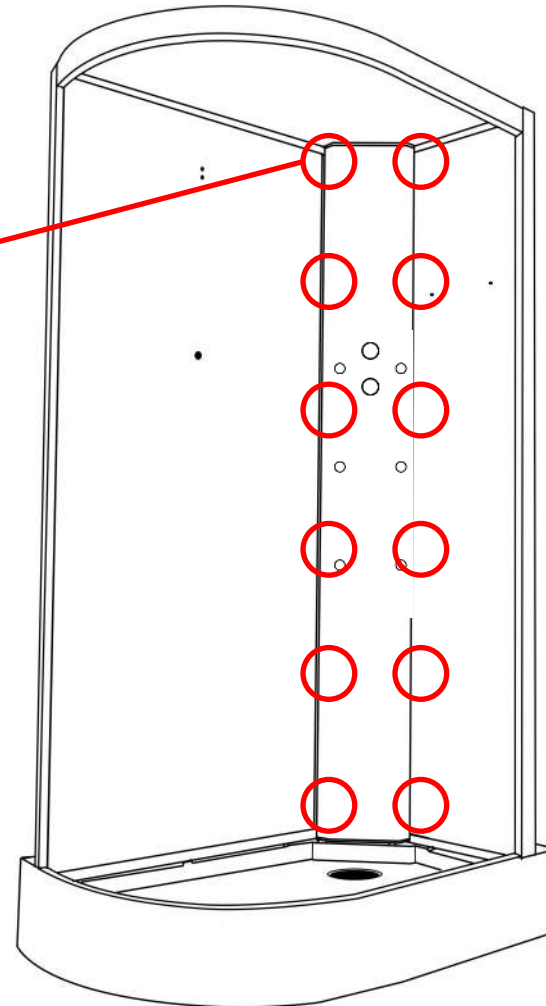
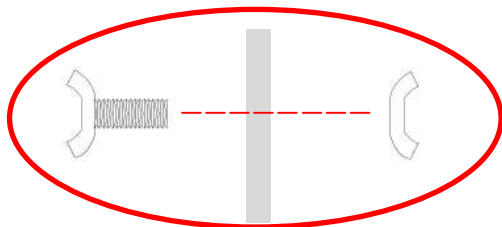

NOTE: Column features varies between models

Step 7 — Fixed Glass Connection

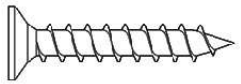

ST16 x 4



PRC20 x 4

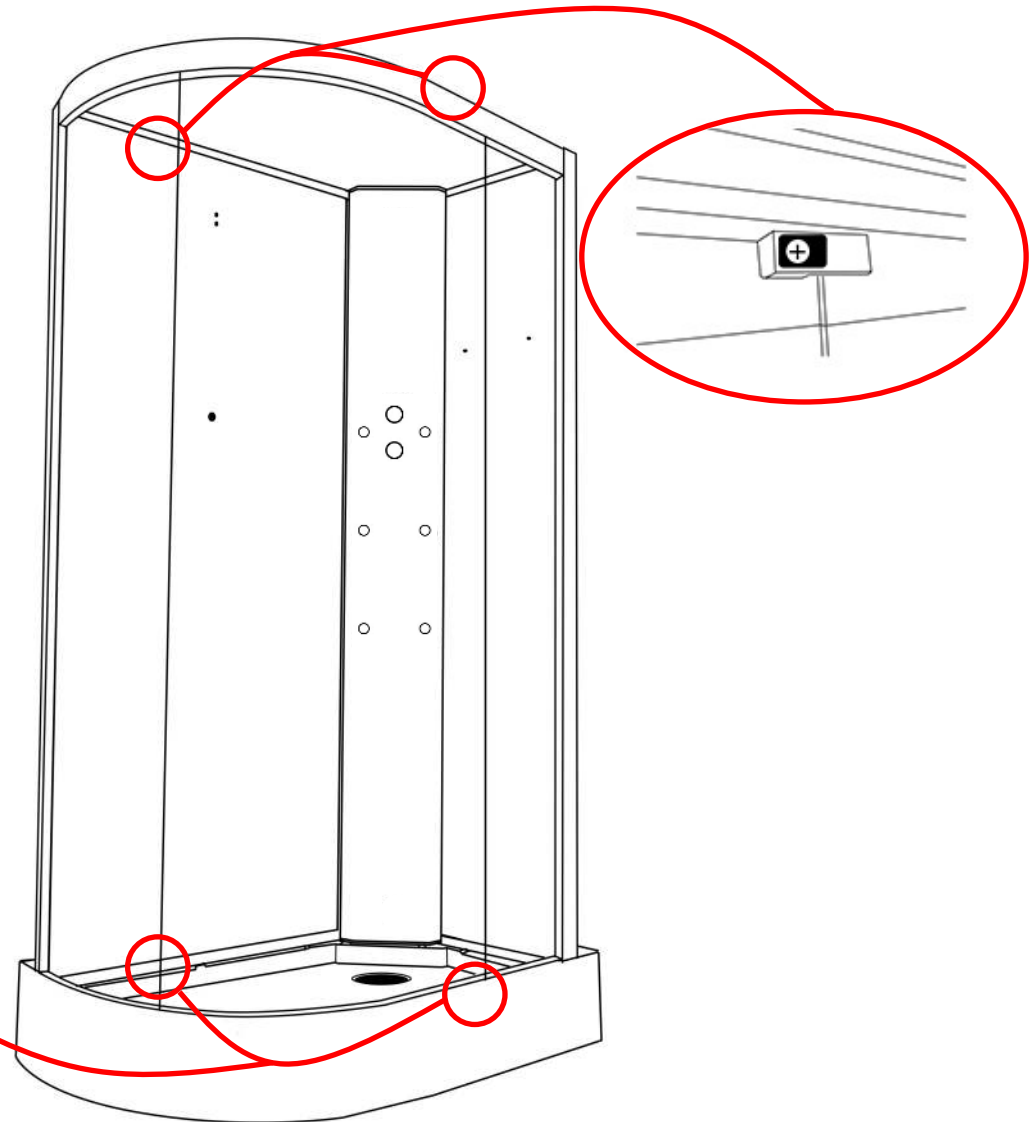
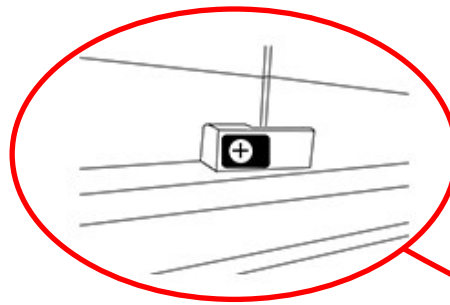
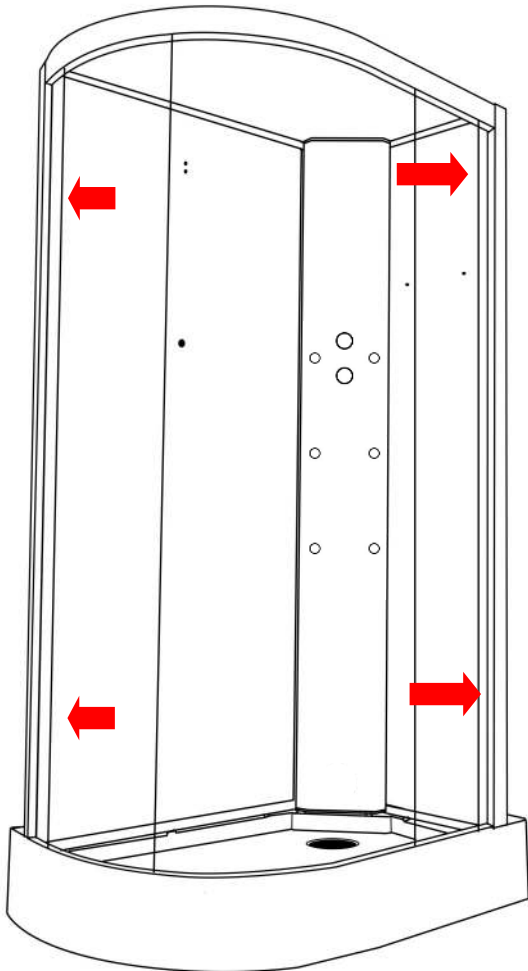

Step 8 — Fitting the glass seals

Fit seal inside the shower between the glass and framework

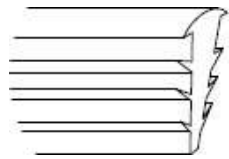

1x 12mm Seal

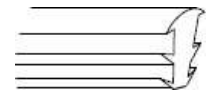

1x 7mm Seal

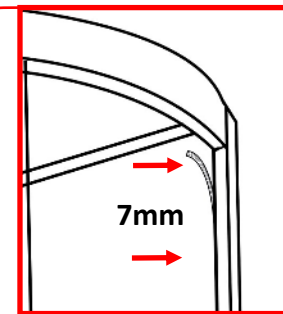
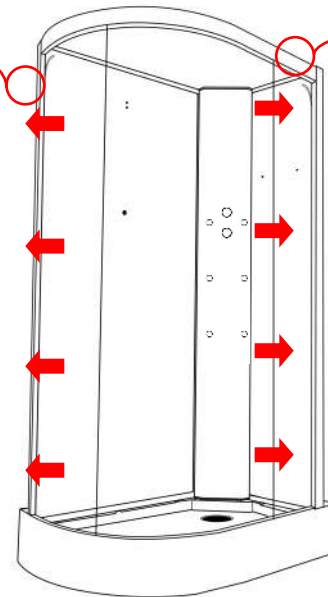
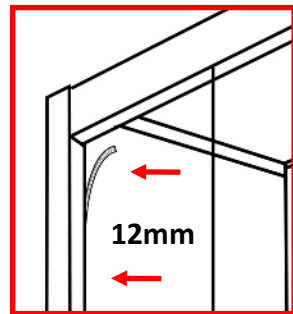

Step 9 — Fitting the door stops

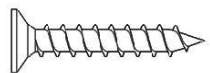

ST10 x8



SP072 x8

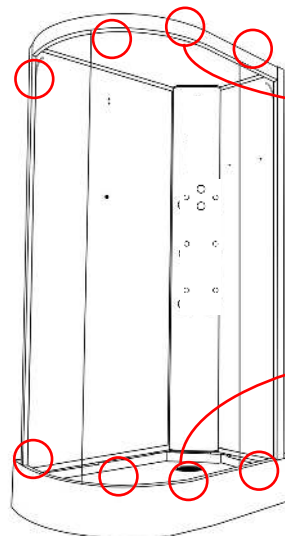

Internal View — Top Rail

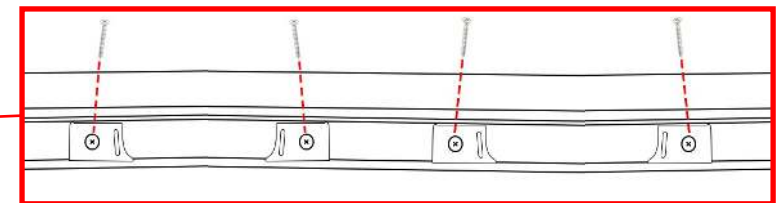
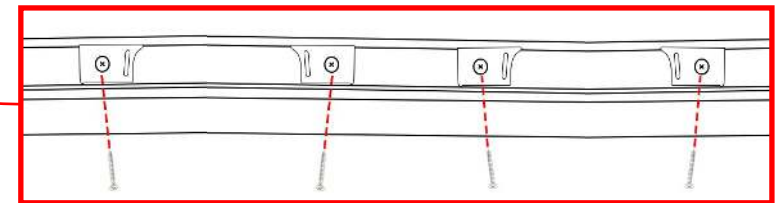

Internal View — Bottom Rail

Step 10 — Attaching the Roof

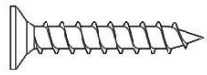

ST16 x6

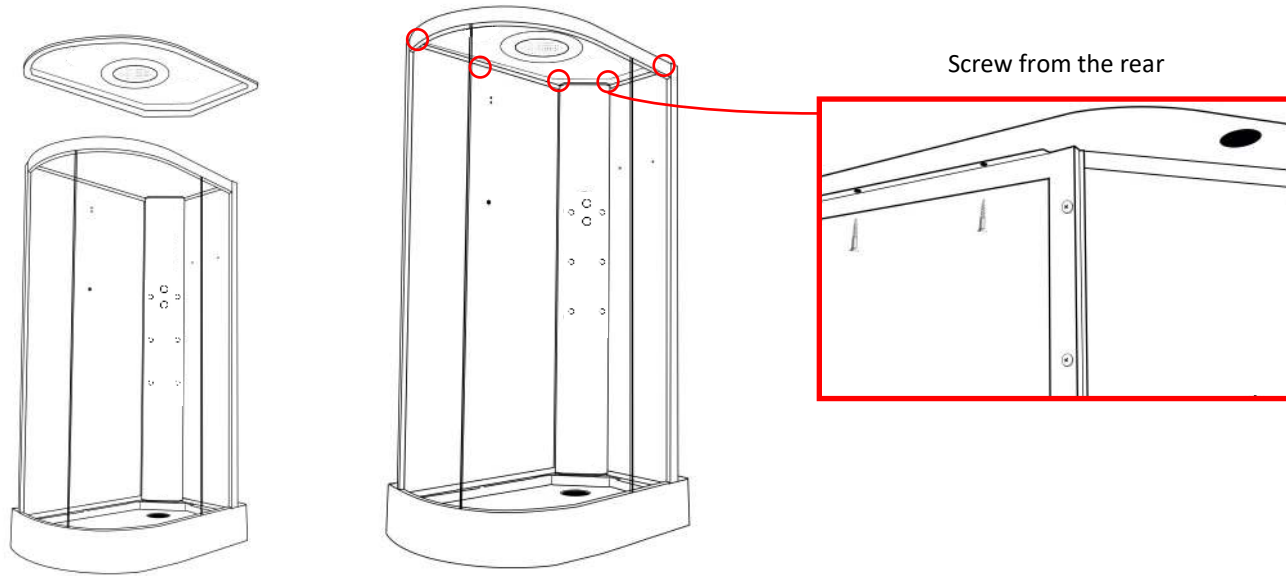

Step 11 — Fit door handles, seals and magnets

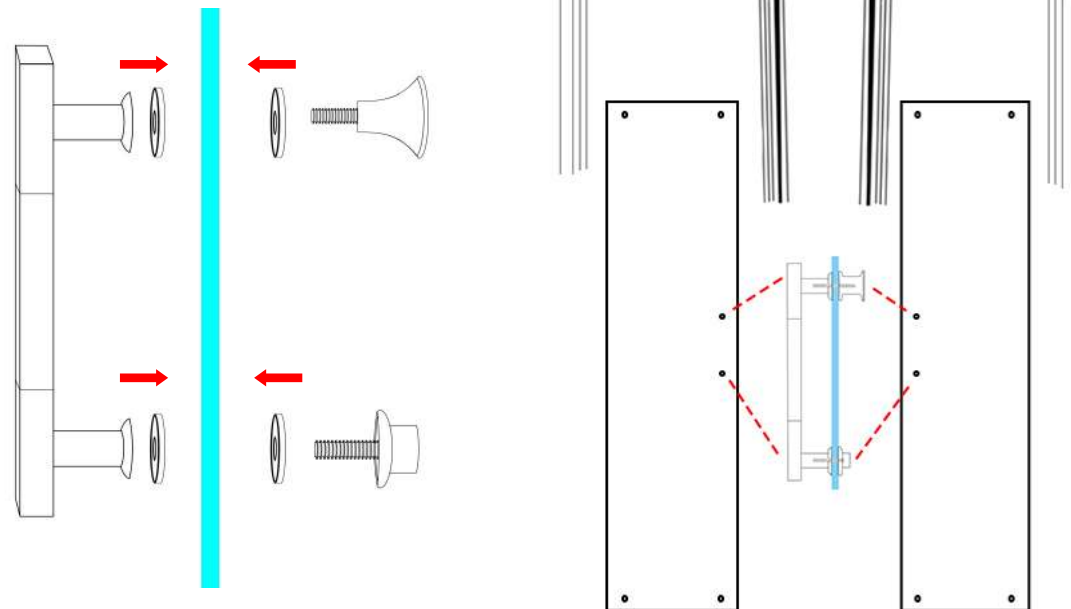

Step 12 — Fit top door wheels x 4

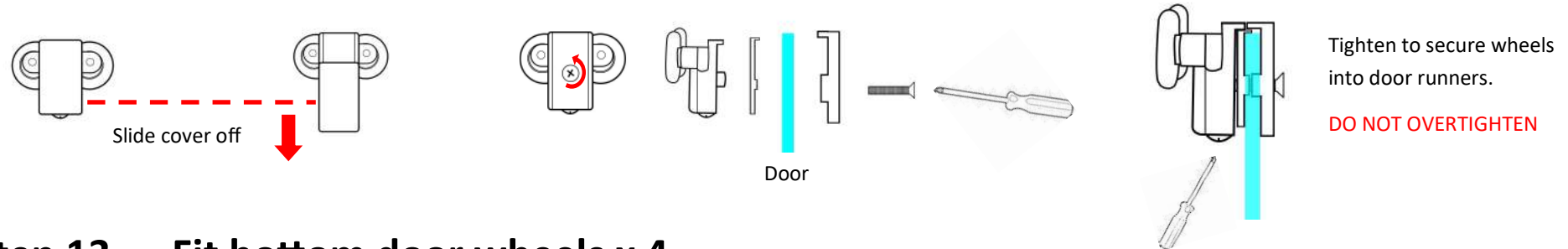

Step 13 — Fit bottom door wheels x 4

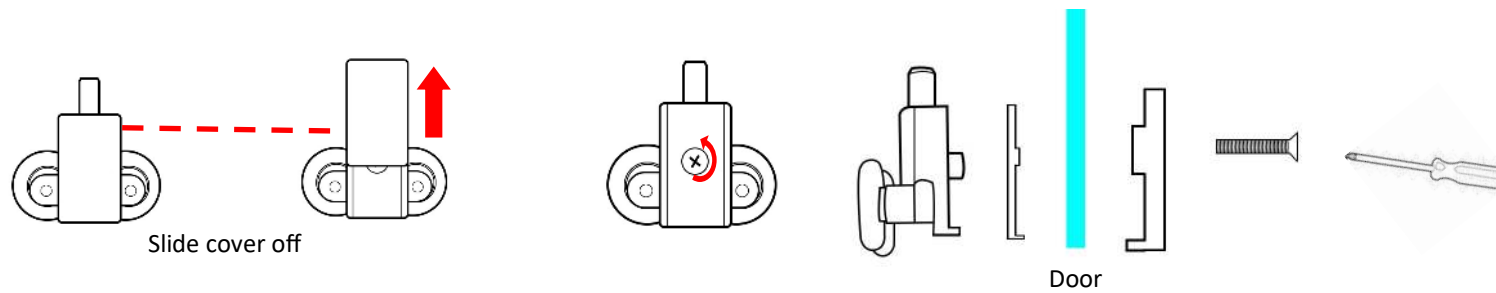

Step 14 — Fitting the doors

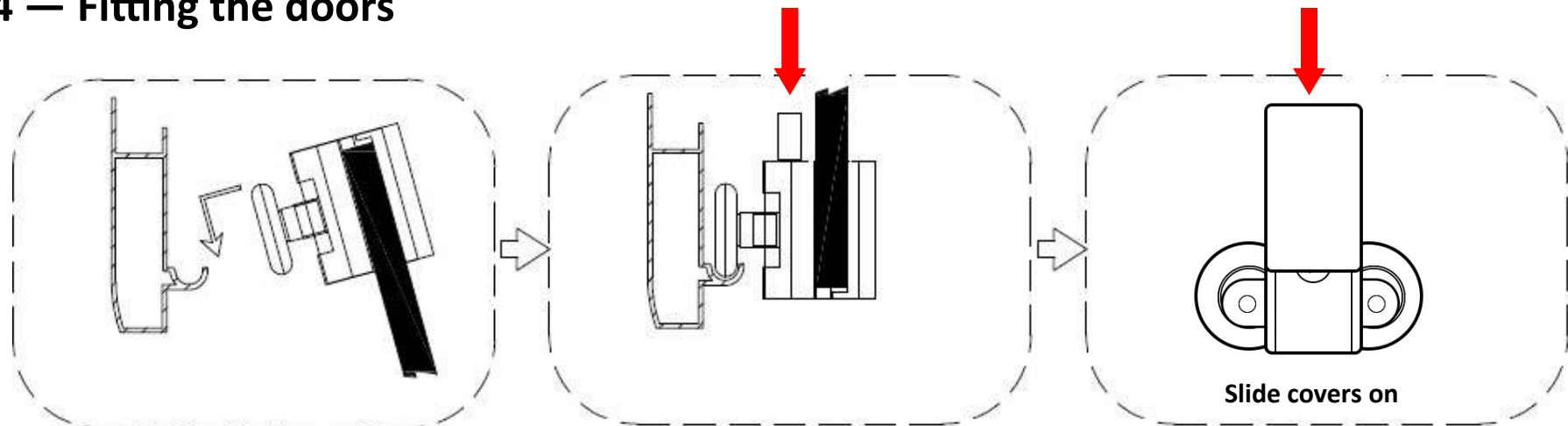

Step 15 — Accessory Installation

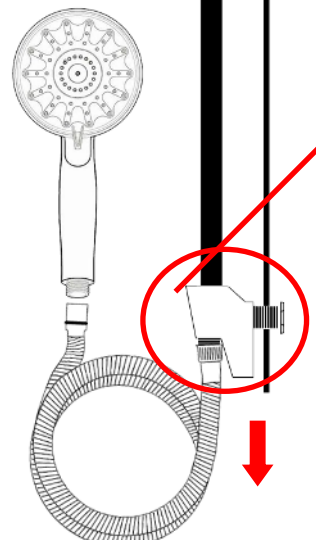
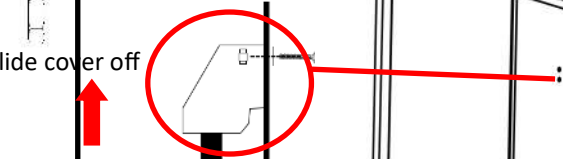
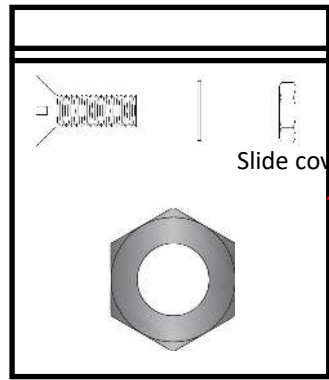

Slide cover off

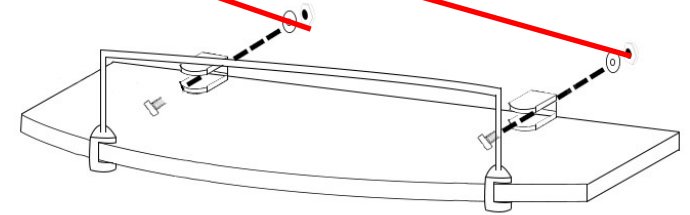
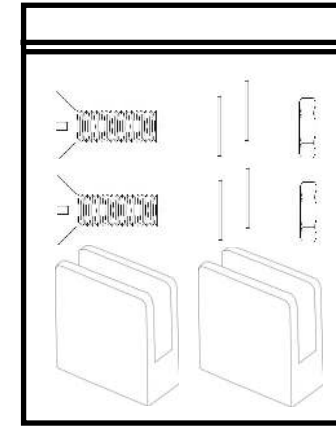
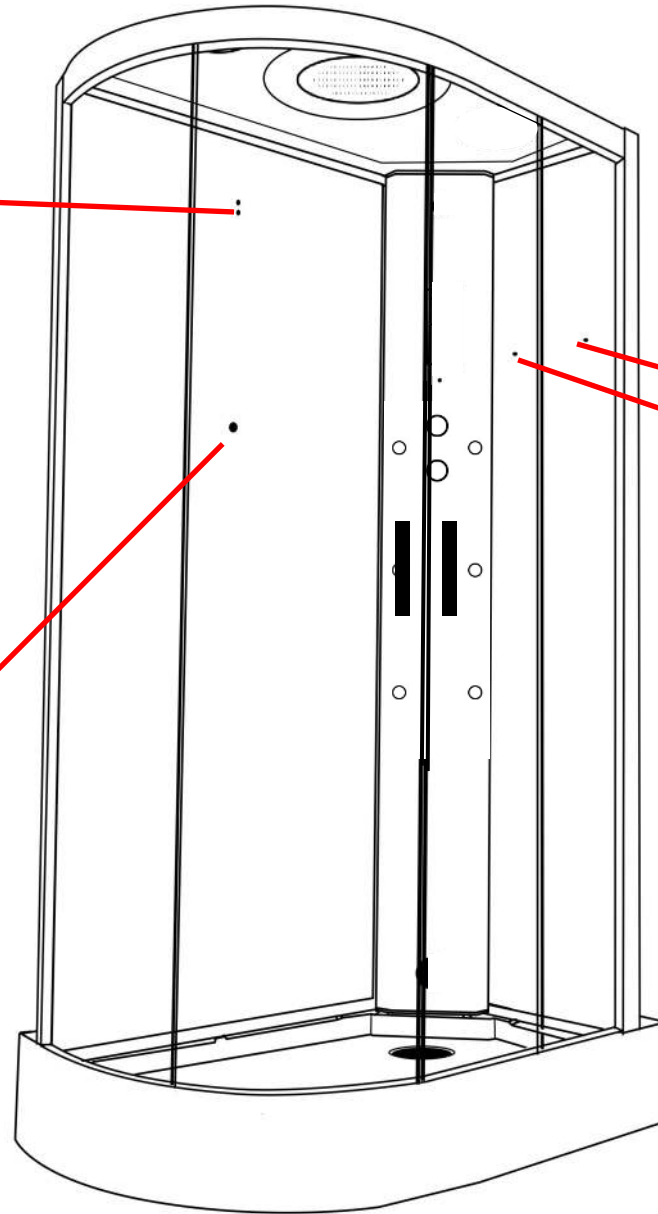

Step 16 — Valve/Water Connections

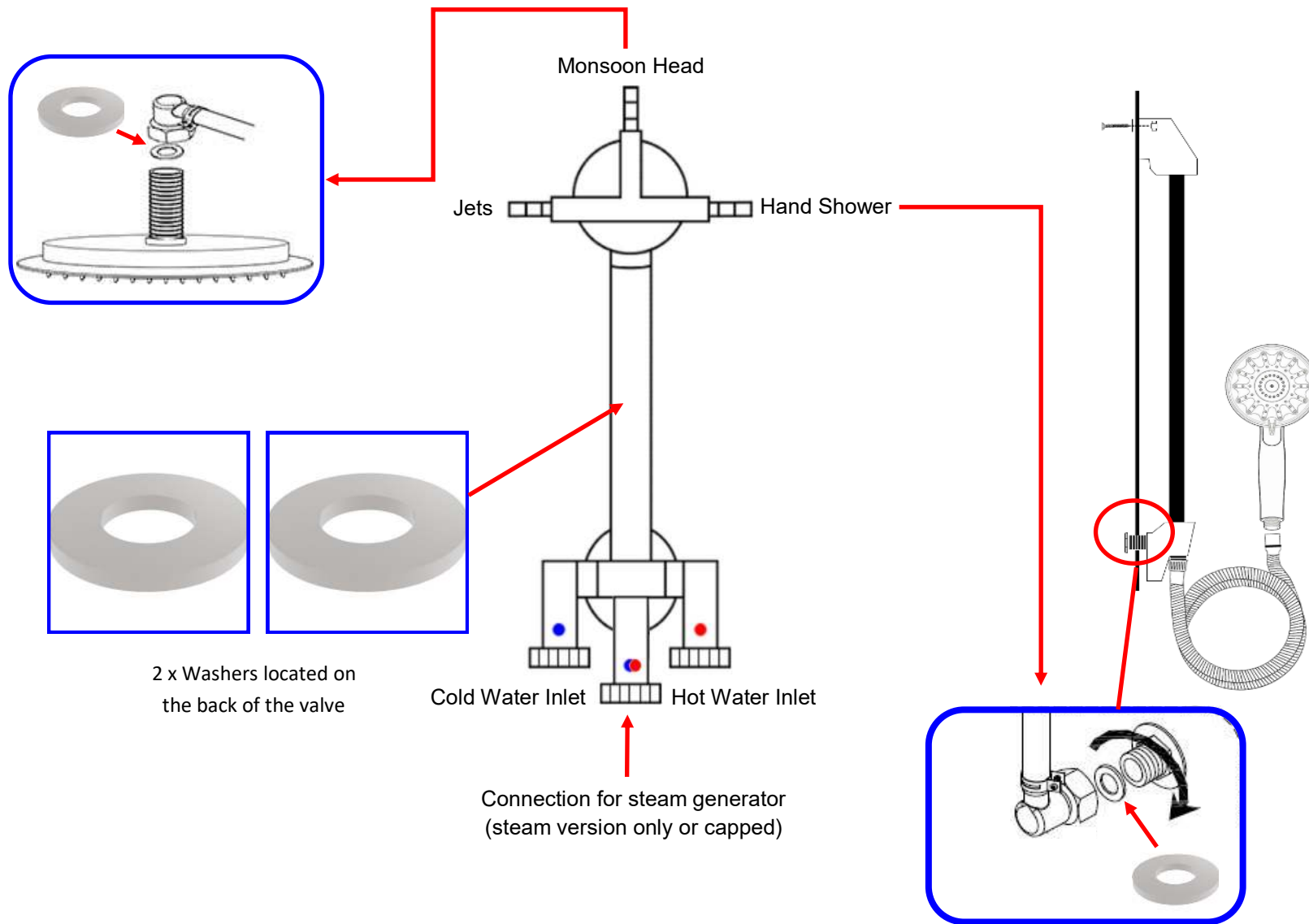

2 x Washers located on the back of the valve

Connection for steam generator (steam version only or capped)

Signing off your shower

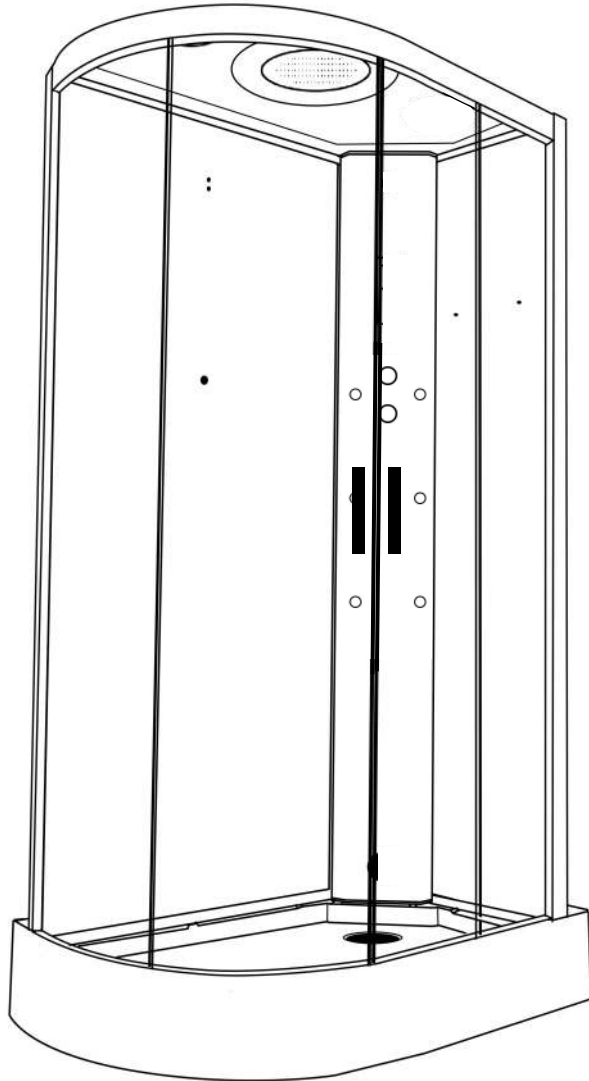

Now your shower is assembled, there is just few steps before you can sign the shower off.

1. Please ensure ALL the connections are watertight including waste, pre-fitted body jets as clips are only lightly tightened in place for transit and can be dislodged, internal and external hoses and steam connections (model dependent)
2. Once you are happy, check the shower functions by switching on the overhead shower and then adjust the selector knob (top knob) to the hand shower and then onto the body jets. Whilst the water is running, check external hoses for any signs or water drips or leaks and tighten accordingly.

Please note, when testing the body jets, water will shoot towards the open doors and the user.

3. Do not aim the hand shower directly at the joints of your shower as this does not fall under “normal showering conditions”. However, due to Insignia’s unique design of the shower tray, water will only leak back in to the tray so you won’t get flooded.
4. Visually check the water flow in to the waste and adjust the feet of the tray accordingly to ensure the direction of the water flows towards to the waste to prevent over puddling (a small amount of puddling is normal).
5. Never use the shower until all checks have been made and the installer is 100% happy in the knowledge no hose leaks are present.
6. Any RubberGum which has squeezed out between the panels and the tray, simply cut off using a sharp, clean knife blade.
7. Now push the shower from it’s base into it’s final position. **NEVER PUSH THE GLASS OR FRAME** into its final resting position.

Happy Showering!

Parts List

Part Code	Part Description
SP010	Monsoon Shower head
SP002	Round Body Jet (Two Open Ends)
SP002A	Round Body Jet (One Open End)
SP236	Complete riser bar
SP112 (warranty)	Shower holder (for riser bar)
SP120 (warranty)	Water Inlet (bottom part of riser bar)
SP142	Shower waste
SP097	Chrome rectangular door handles
SP190	Glass Shelf
SP072	Door stoppers
SP276	Twin Door Wheels Non-Push
SP276A	Twin Door Wheels Push Button
SP105	Chrome Flexible Hose
SP152	Multi-functional Hand Shower
SP194	Fixed Glass Seals (12mm)
SP197	Fixed Glass Seals (7mm)
SP407	LeakFree Framework Securing Clip (Black)
SP407B	LeakFree Framework Securing Clip (Chrome)
SP025	Chrome Knob for Selector/Water Flow Dial
SP116A	Water Valve Chrome Selection Plate

SP300	Waste hose
SP308	Magnetic door seals
SP310	Rear door seals
SP245	3 port – 2 feed non thermostatic valve
SP193	3 Port Selector Cartridge
SP091	Tap cartridge
SP321	LeakFree Column End Caps
SP101	UPVC Hose

Steam Room & Shower Safety Guide

1. Never leave children unattended in the shower or bath.
2. Never bath children (under 12) using whirlpool function if fitted.
3. Regulate the temperature of water before showering.
4. Never allow children to use the steam function. This function is for **ADULTS ONLY**.
5. Always be aware of the steam outlet position. Never use in close proximity to the person using it.
6. Exit the steam room immediately if feeling dizzy, faint or short of breath.
7. Do NOT use the steam room if you're pregnant, have a heart condition, have low or high blood pressure. If you're unsure consult your GP before use.
8. If you have any underlying health conditions which you feel could be aggravated by using a steam room, consult your GP before use.
9. If you begin to have any issues with your health after using a steam room, stop immediately and consult your GP regarding your symptoms before continuing to use.
10. Consult your GP before using the steam room if you're on medication at all, especially with drowsy side effects.
11. Never use this shower if you have been drinking alcohol or under the influence of other substances.
12. Never use with more than one person unless the shower is designed for this.
13. This product is not to be used for washing/bathing animals.
14. Always turn power supply off after use.
15. Always turn water supply off after use.
16. Ensure room is well ventilated after a steam session by using your bathroom extraction fan or opening a window.

WEEE Compliance Statement

The UK Waste Electrical and Electronic Equipment (WEEE) regulations came into force on 2 January 2007. Under this new legislation, producers of electrical and electronic equipment (EEE) have to fulfil certain obligations.

Under the WEEE directive Insignia is considered the producer of certain products we supply and in line with the demands of the legislation we are pleased to offer the opportunity to return these products to us for treatment and recycling.

Insignia products will generally have an identifying mark and the common crossed out wheelie bin label. We accept returns of all products carrying the Insignia brand. All other products are either considered outside the scope of WEEE or Insignia is not technically the producer of these products. Insignia also accepts historic like-for-like WEEE returns. All WEEE returned to Insignia will be recycled in appropriate treatment and recycling centres in accordance with the legislation. If you wish to return any products to us, please send your item(s) to our head office.

Company Contract No. 326457

WEEE Producer No. CBDU64227

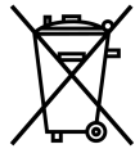

LABELLING

Products labelled with the WEEE symbol (a crossed out “waste bin”) indicate that the final user should not discard this product along with other household waste, but that it must be collected and treated separately.



Returns Address for WEEE

Insignia

9a Deans Road, Old Wolverton, Canon Industrial Park, Milton Keynes, Buckinghamshire, MK12 5NA, UK



EU – Declaration of Performance

Insignia declares that all its products complies with the essential requirements and other relevant provisions of Directive 305/2011/EC. A copy of the Declaration of performance is available from www.insigniashowers.com/ce-certification

Insignia™ is a registered trademark of Maclean International Ltd, 9a Deans Road, Old Wolverton, Canon Industrial Park, Milton Keynes, Buckinghamshire, MK12 5NA, UK

All images are subject to copyright. Images may not be used in any way shape or form without written permission from Maclean International Ltd. Images are NOT permitted to be saved, printed or uploaded. Violation of copyright laws are punishable by law.

All images are registered with
ImageTraker

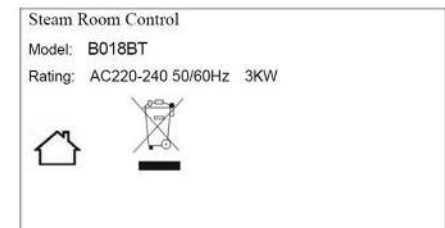
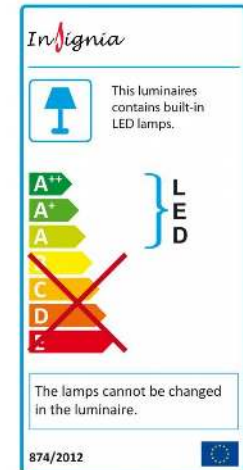

Insignia™ is a registered trademark of Maclean International Ltd

All images are subject to copyright. Images may not be used in any way shape or form with out written permission from Maclean International Ltd. Images are NOT permitted to be saved, printed or uploaded. Violation of copyright laws are punishable by law.