

Achtung: Bitte platzieren Sie die Beine entsprechend der Beschriftung.
Attention: Please place the legs according to the label.

Montage mit zwei Personen!
Assembly requires two People!

80 kg
(shelf: 8 kg)

1

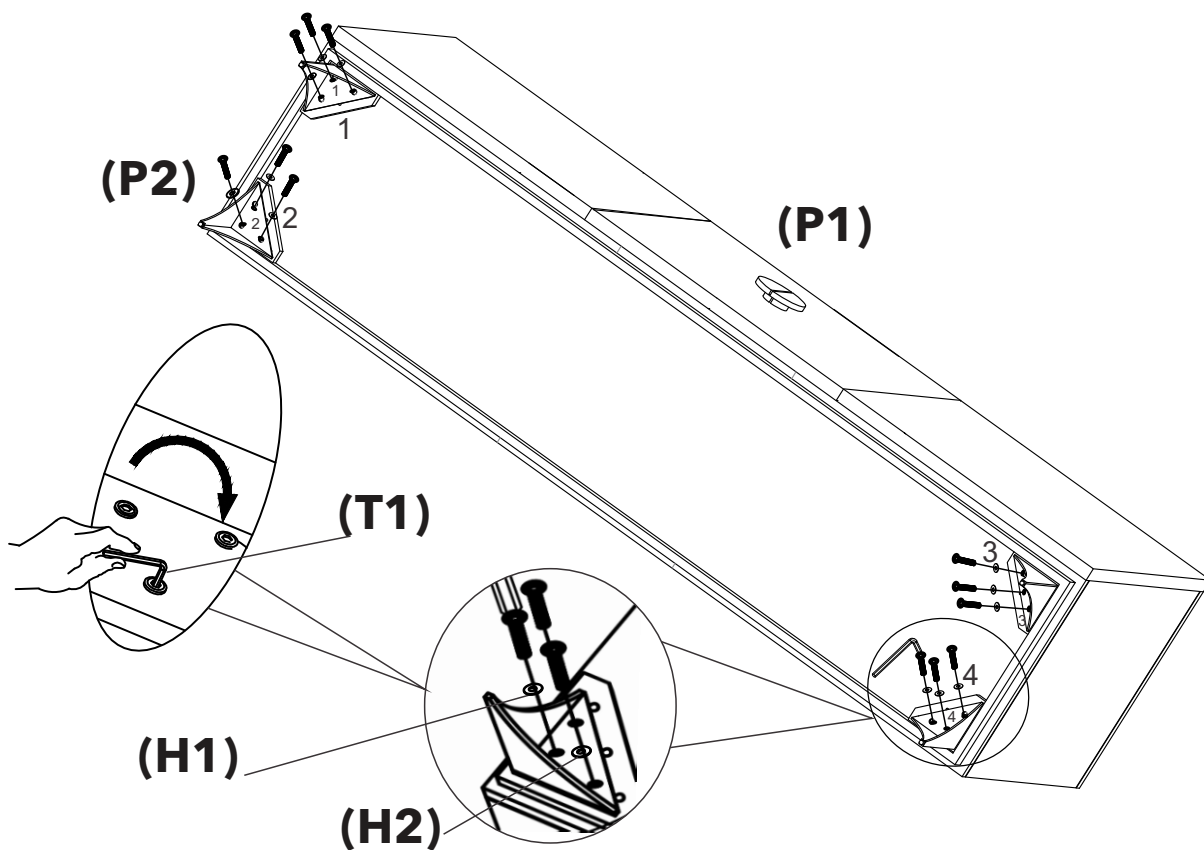

2

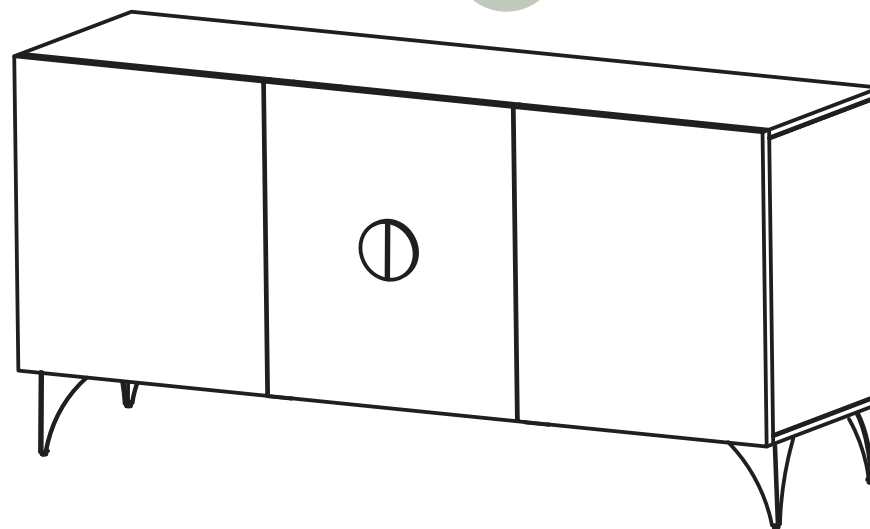

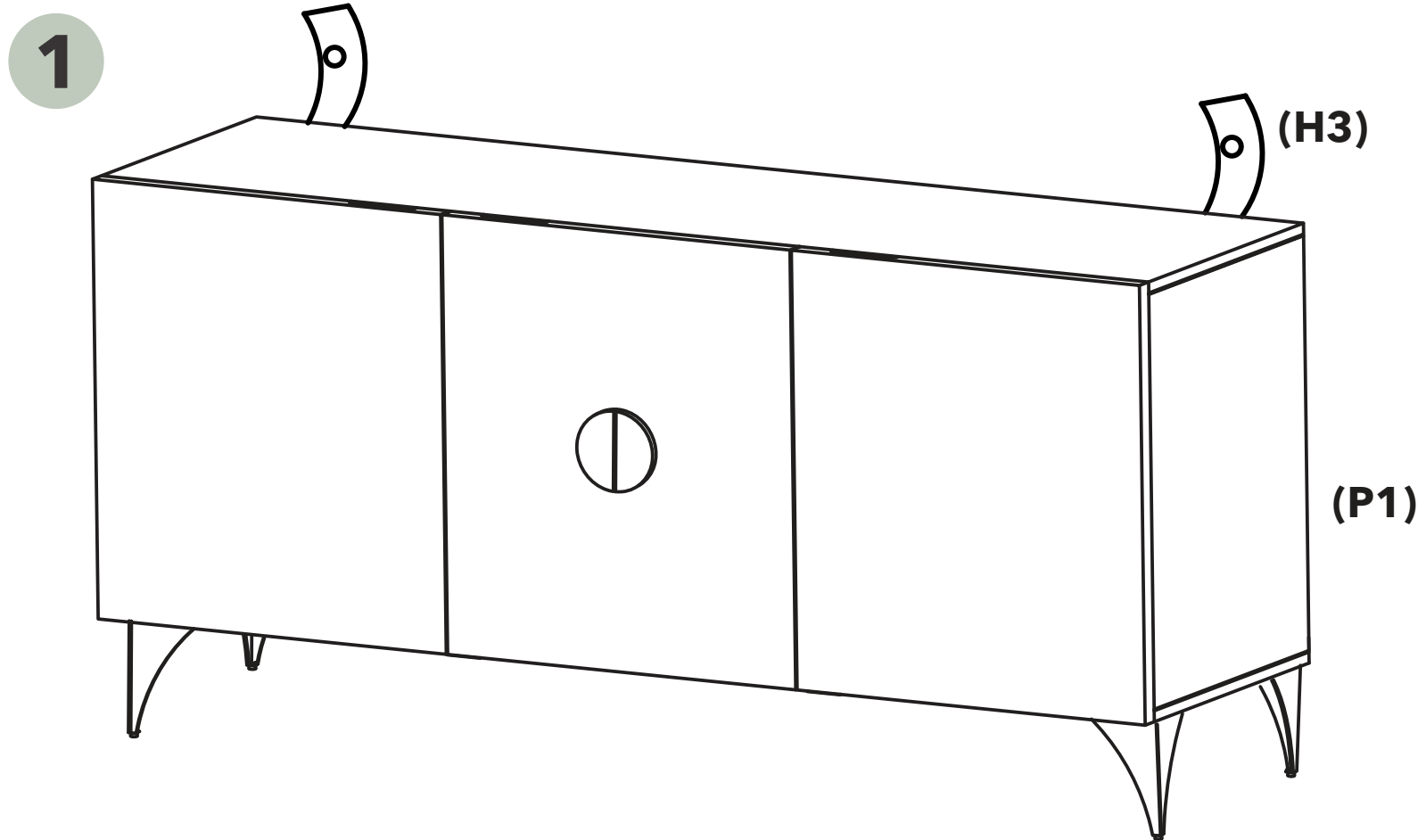
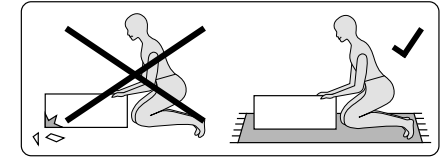
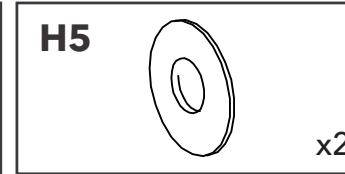
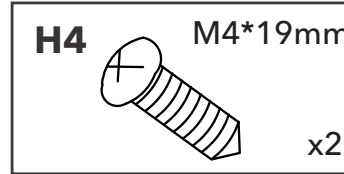
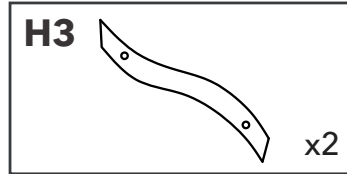
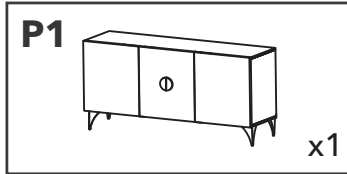

Zur richtigen Einstellung der Höhe der Tür,

kleine Schrauben einstellen und Stellen Sie dann die Schrauben ein in größerem Loch.

For proper adjustment of height of door, adjust small screws and then adjust screws in bigger hole.

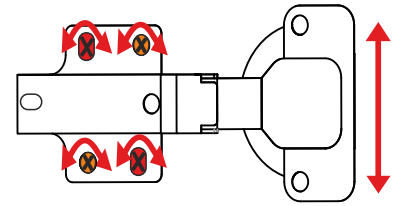
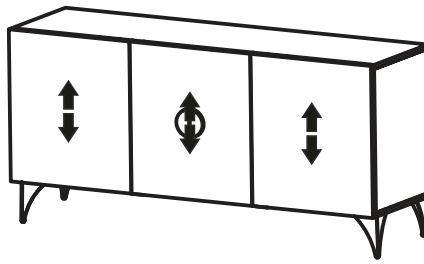

Tiefe einstellen

Mit der hinteren Schraube lässt sich der Abstand der Tür zum Schrankkorpus verändern.

Adjust depth

With the back screw the distance of the door to the cabinet body change.

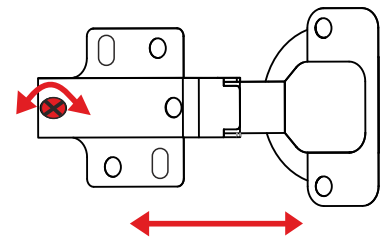
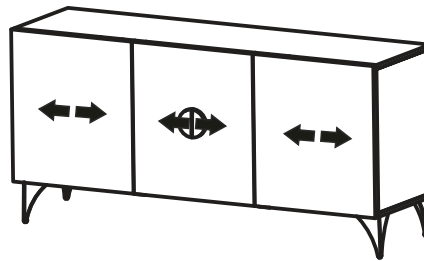

Seitwärts ausrichten

Hängt die Tür schief, lässt sich dies mit der vorderen Schraube korrigieren.

Align sideways

The door is crooked can this be done with the front screw correct.

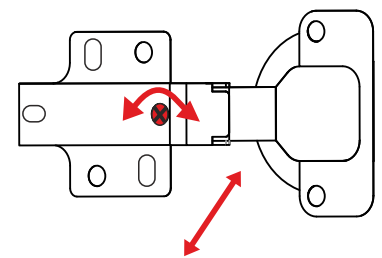
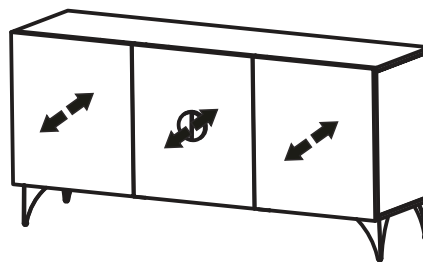

Bitte Scannen Sie den QR Code um zu einem detaillierten Anleitungsvideo zu gelangen.
Please scan the QR code and you will be directed to an instruction video with detailed explanation.



HINWEIS: Befolgen Sie bei Türausrichtungen bei Bedarf diesen Schritt.

NOTE: For Door alignments, Please follow this step if needed.