

Stadium 62CF

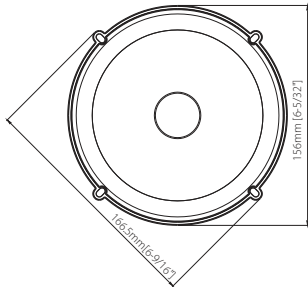

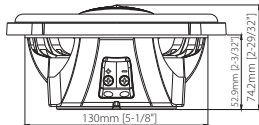

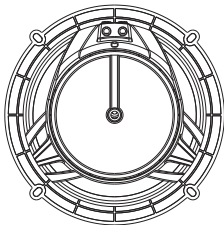

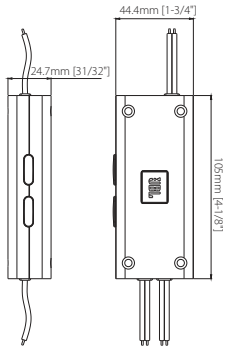
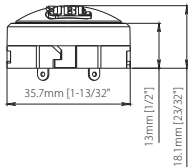
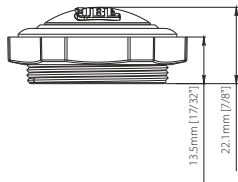
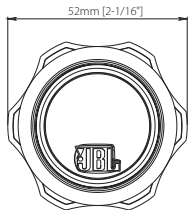
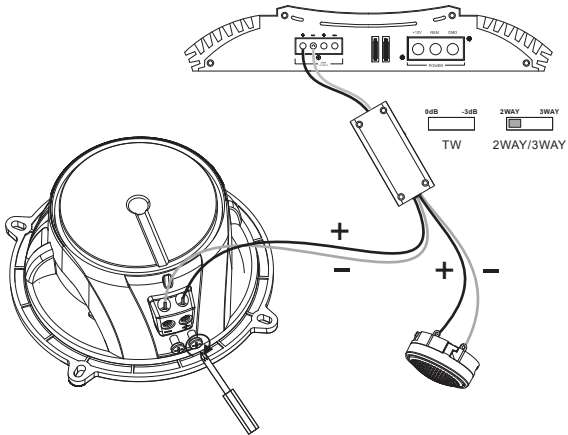
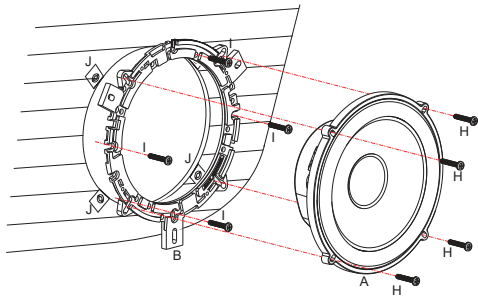

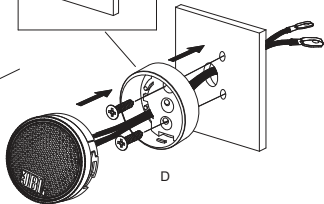
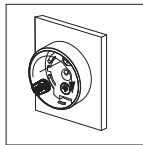
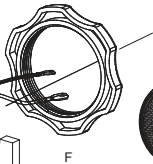
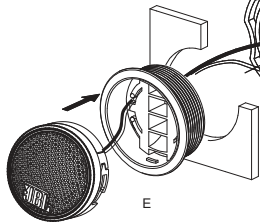
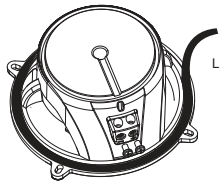

Specifications

- Type: 6-1/2" (165 mm) Two-way Component Speaker System
- Power Handling: 110 Wrms, 330 W peak
- Sensitivity (@ 2.83 V): 93 dB
- Frequency Response: 45 Hz – 40 kHz
- Impedance: 3.0 ohms

Thiele-Small Parameters

- BL (Tm): 4.45
- DCR (ohms): 2.70
- Mms (g): 14.62
- Sd (cm²): 143.14
- Cms (mm/N): 0.25
- Vas (l): 7.34
- Fs (Hz): 82.70
- Qes: 1.02
- Qms: 8.47
- Qts: 0.91
- Crossover Point: 4.6 kHz



HARMAN International
Industries, Incorporated 8500
Balboa Boulevard, Northridge,
CA 91329 USA

© 2021 HARMAN International
Industries, Incorporated.

All rights reserved.

JBL is a trademark of HARMAN International Industries,
Incorporated, registered in the United States and/or other
countries.

Features, specifications and appearance are subject to change
without notice.



STADIUM SPEAKERS

Sleek and Powerful Multi-element Car Audio Speakers and Component Systems Designed and Engineered to Bring Iconic JBL Sound to More Cars than Ever Before. Dare to listen



Ultimate Car Audio by JBL.

JBL's Stadium Series speakers – available in 2", 3", 5-1/4", 6-1/2", 6" x 8", 4" x 6", 6" x 9", and 3/4" – bring iconic JBL sound that can only come from a 75-year pedigree of audio excellence to virtually any car on the road. Stadium's Plus One™ fiberglass woofers deliver high-output, deep and robust bass. The high-resolution 3/4" edge-driven textile dome tweeters deliver soaring highs up to 40kHz. 2" and 3" midranges are available to upgrade two-way component systems into three-way. The compact 3" midrange speakers also offer a perfect plug-and-play solution with low frequency response to 300Hz, and high sensitivity.

Features

- ▶ 40kHz High-resolution Aluminum Dome Tweeter
- ▶ Patented Plus One™ Glass Fiber Woofers
- ▶ 0dB or -3dB Tweeter Output Level Control
- ▶ UniPivot and Angled Tweeter
- ▶ 3-way Upgradability
- ▶ Super Compact Design and High Sensitivity 3" Midrange Speaker
- ▶ Sleek and Powerful Industry Design
- ▶ Slim and Smart Crossover Design



STADIUM SPEAKERS

Sleek and Powerful Multi-element Car Audio Speakers and Component Systems Designed and Engineered to Bring Iconic JBL Sound to More Cars than Ever Before. Dare to listen



Features and Benefits

40kHz High-resolution Aluminum Dome Tweeter

Stadium edge-driven aluminum dome tweeters equipped with oversized voice coils deliver unforgettable audio experience with impressive thermal power handling and 40kHz high resolution. Turn every drive into your personal concert.

Patented Plus One™ Glass Fiber Woofers

Patented Plus One™ fiberglass woofer cones leverage lighter weight and increased stiffness for a visceral bass experience for the whole body. Dare to listen.

0dB or -3dB Tweeter Output Level Control

The push-button on the angled tweeter allows tweeter output level control of 0dB or -3dB to optimize system linearity based on installation location.

UniPivot and Angled Tweeter

For 5-1/4", 6-1/2" and 6" x 8" coaxial models, the tweeters are angled and can be rotated 270° after installation on most models. This gives you imaging options and the ability to elevate the soundstage on low mounted speakers.

3-way Upgradability

Looking to 3-way component system upgrade? Stadium 2-way component system crossovers are equipped with 2-way and 3-way selections, giving you the flexibility to add the optional 2" or 3" midrange with perfect tonal balance.

Super Compact Design and High Sensitivity 3" Midrange Speaker

Stadium 3" midrange delivers low-frequency response to 300Hz while keeping high sensitivity over 89dB. The super compact design and premium performance allows the midrange to fit more vehicles without sacrificing any of your audio experience.

Sleek and Powerful Industry Design

Intelligent design that complements the aesthetic of any car while filling it with premium sound.

Slim and Smart Crossover Design

Stadium component systems all have very slim crossovers, which equipped with connection cable for easy installation. The push-button on crossover allows tweeter output level control of 0dB or -3dB to optimize system linearity based on installation location.



STADIUM SPEAKERS

Sleek and Powerful Multi-element Car Audio Speakers and Component Systems Designed and Engineered to Bring Iconic JBL Sound to More Cars than Ever Before. Dare to listen

What's in the box:

STADIUM 22S

2x Midrange driver
2x Grilles
2x Crossovers
2x Cables
2x Custom Fit Mounting Adapters
2x Foam gaskets
24x Screws
8x Speed clips
1x Allen head bit (2.5mm)
2x JBL logo badges
2x Brand stickers
Owner's manual

STADIUM 62CF

2x Speakers
2x Plastic multi-hole adapter rings
2x Foam gaskets
2x Crossovers
2x Tweeters
2x Threaded flush-mount adapters
2x Plastics locking nuts
2x Surface-mount cups
2x Starfish tweeter mounts
30x Screws
16x Speed clips
1x Allen head bit (2.5mm)
2x JBL logo badges
2x Brand stickers
Owner's manual

STADIUM 62F

2x Speakers
2x Plastic multi-hole adapter rings
2x Foam gaskets
16x Screws
8x Speed clips
2x JBL logo badges
2x Brand stickers
Owner's manual

STADIUM 862CF

2x Speakers
2x Spacers
2x Foam gaskets
2x Crossovers
2x Tweeters
2x Threaded flush-mount adapters
2x Plastic locking nuts
2x Surface-mount cups
2x Starfish tweeter mounts
22x Screws
16x Speed clips
1x Allen head bit (2.5mm)
2x JBL logo badges
2x Brand stickers
Owner's manual

STADIUM 862F

2x Speakers
2x Spacers
2x Foam gaskets
8x Screws
8x Speed clips
2x JBL logo badges
2x Brand stickers
Owner's manual

STADIUM 962C

2x Speakers
2x Grilles
2x Spacers
2x Foam gaskets
2x Crossovers
2x Tweeters
2x Threaded flush-mount adapters
2x Plastic locking nuts
2x Surface-mount cups
2x Starfish tweeter mounts
22x Screws
16x Speed clips
1x Allen head bit (2.5mm)
2x JBL logo badges
2x Brand stickers
Owner's manual

STADIUM 962M

2x Speakers
2x Grilles
2x Spacers
2x Foam gaskets
8x Screws
8x Speed clips
2x JBL logo badges
2x Brand stickers
Owner's manual

STADIUM 32S

2x Midrange driver
2x Grilles
2x Crossovers
2x Cables
2x Foam gaskets
16x Screws
8x Speed clips
1x Allen head bit (2.5mm)
2x JBL logo badges
2x Brand stickers
Owner's manual

STADIUM 52F

2x Speakers
2x Foam gaskets
8x Screws
8x Speed clips
2x JBL logo badges
2x Brand stickers
Owner's manual

STADIUM 52CF

2x Speakers
2x Foam gaskets
2x Crossovers
2x Tweeters
2x Threaded flush-mount adapters
2x Plastics locking nuts
2x Surface-mount cups
2x Starfish tweeter mounts
22x Screws
16x Speed clips
1x Allen head bit (2.5mm)
2x JBL logo badges
2x Brand stickers
Owner's manual

STADIUM 192T

2x Tweeters
2x Threaded flush-mount adapters
2x Plastic locking nuts
2x Surface-mount cups
2x Starfish tweeter mounts
6x Screws
2x Crossovers
2x JBL logo badges
2x Brand stickers
Owner's manual

DRAFT



STADIUM SPEAKERS

Sleek and Powerful Multi-element Car Audio Speakers and Component Systems Designed and Engineered to Bring Iconic JBL Sound to More Cars than Ever Before. Dare to listen

Technical Specifications:

STADIUM 22S

2" (50mm) PEI Dome Midrange with Bandpass Crossover Enclosure

Power Handling: 50Wrms, 150W peak
Sensitivity (@ 2.83V): 94dB
Frequency Response: 500Hz – 7kHz
Impedance: 3.0 ohms
Gross weight: 0.82kg

STADIUM 62CF

6-1/2" (165mm) Two-way Component Speaker System

Power Handling: 110Wrms, 330W peak
Sensitivity (@ 2.83V): 93dB
Frequency Response: 45Hz – 40kHz
Impedance: 3.0 ohms
Gross weight: 2.9kg

STADIUM 62F

6-1/2" (165mm) Two-way Car Speaker

Power Handling: 85Wrms, 255W peak
Sensitivity (@ 2.83V): 93dB
Frequency Response: 45Hz – 40kHz
Impedance: 3.0 ohms
Gross weight: 2.56kg

STADIUM 862CF

6" x 8" (147mm x 205mm) Two-way Component Speaker System

Power Handling: 120Wrms, 360W peak
Sensitivity (@ 2.83V): 93dB
Frequency Response: 40Hz – 40kHz
Impedance: 3.0 ohms
Gross weight: 3.02kg

STADIUM 862F

6" x 8" (147mm x 205mm) Two-way Car Speaker

Power Handling: 100Wrms, 300W peak
Sensitivity (@ 2.83V): 93dB
Frequency Response: 40Hz – 40kHz
Impedance: 3.0 ohms
Gross weight: 2.84kg

STADIUM 962C

6" x 9" (168mm x 240mm) Two-way Component Speaker System

Power Handling: 145Wrms, 435W peak
Sensitivity (@ 2.83V): 94dB
Frequency Response: 35Hz – 40kHz
Impedance: 3.0 ohms
Gross weight: 5.26kg

STADIUM 962M

6" x 9" (168mm x 240mm) Three-way Car Speaker

Power Handling: 120Wrms, 360W peak
Sensitivity (@ 2.83V): 94dB
Frequency Response: 35Hz – 40kHz
Impedance: 3.0 ohms
Gross weight: 5.02kg

STADIUM 32S

3" (89mm) Midrange with Bandpass Crossover Enclosure

Power Handling: 55Wrms, 165W peak
Sensitivity (@ 2.83V): 93dB
Frequency Response: 200Hz – 15kHz
Impedance: 3.0 ohms
Gross weight: 0.78kg

STADIUM 52F

5-1/4" (133mm) Two-Way Car Speaker

Power Handling: 60Wrms, 180W peak
Sensitivity (@ 2.83V): 93dB
Frequency Response: 55Hz – 40kHz
Impedance: 3.0 ohms
Gross weight: 2.2kg

STADIUM 52CF

5-1/4" (133mm) Two-Way Component Speaker System

Power Handling: 80Wrms, 240W peak
Sensitivity (@ 2.83V): 93dB
Frequency Response: 55Hz – 40kHz
Impedance: 3.0 ohms
Gross weight: 2.52kg

STADIUM 192T

3/4" (19mm) Edge-Driven Aluminum Dome Tweeter

Power Handling: 50Wrms, 150W peak
Sensitivity (@ 2.83V): 93dB
Frequency Response: 2kHz – 40kHz
Impedance: 3.0 ohms
Gross weight: 0.306kg

