

*For the Best*

### 14MM-PR07 INSTRUCTION MANUAL



### TABLE OF CONTENTS

<b>1. Introduction</b>	1
1.1. Product Description	1
1.2. Typical Installation	1
1.3. Package Contents	1
1.4. Hardware Installation (217x165mm)	1
1.5. Mounting The Profiler Revolution	1
1.6. Configuring The Profiler Revolution	2
<b>2. Technical Specifications</b>	4
<b>3. Block Diagram</b>	4
<b>4. Safety Instructions</b>	5
<b>5. Conditions Of Warranty</b>	5

No part of this manual may be copied, reproduced, transmitted, transcribed or translated into any language without permission. Matchmaster reserves the right to change the specifications of the hardware and software described in these manuals at any time. Matchmaster cannot be held liable for any damages resulting from the use of this product. Specifications are subject to change without notice. 10/19

### 1. INTRODUCTION

#### 1.1 Product description

The Johansson Profiler Revolution is an easy to use programmable filter amplifier and converter for terrestrial signals. The module optimizes terrestrial VHF/UHF and FM signals from multiple inputs with the goal to provide high quality images on your TV screen. The state-of-the-art programmable filter amplifier has no equivalent on the market due to its revolutionary technology:

- Can process more than 50 channels (32 filters)
- Can process S-Band output channels
- Can convert a wide selection of channels
- Sharpest filters on the market (>50dB on adjacent channels)
- Real-time AGC on all individual filters
- Complete flexibility in assigning filters from any input. Each channel can be frequency shifted to any other channel in the VHF or UHF band (Flex Matrix)
- To avoid unauthorized persons changing the settings, all Profiler products can be locked with a security code

- Made in Europe, for worldwide application
- 5 inputs: FM / 4 x VHF-UHF / >50 channels / AGC / 12-24 V remote power
- Product dimensions (H X W X D): 165mm x 217mm x 59mm

#### 1.2 Typical installation

The Profiler Revolution can be used to provide high quality television images and FM signals in a wide range of projects, both in the hospitality as in the residential market. Typical buildings or infrastructures where the Profiler Revolution can be used include, but are not limited to:

- Large and small hotels, hostels, bed and breakfasts, holiday parks
- Hospitals, nursing homes, prisons, settlements
- Large and small multi-dwelling units

#### 1.3 Package contents

- 1 Profiler Revolution (ref. 14MM-PR07)
- 1 Power Adapter Cord (180cm)

#### 1.4 Hardware installation (217x165mm)



1. 5 inputs: 4 VHF/UHF and 1 FM
2. Grounding clamp
3. Use the popular Johansson button to navigate through the menu
4. Power supply socket
5. Status LED
6. SD card slot for configuration input/copy
7. Output signal
8. Output signal
9. Test port to control the output signal quality

#### 1.5 Mounting the Profiler Revolution

- **Important:** Mount the module vertically to a wall in a well-ventilated room and leave a minimum space of 15 cm around the product to guarantee maximum ventilation of the product
- Connect an earth wire to the grounding clamp
- Connect the power adapter cord to the power supply socket. Check the status LED for the indication of DC power presence
- Connect the VHF/UHF and/or FM inputs to the Profiler Revolution
- Connect a coaxial cable to the output connector for distribution of the signal
- Connect a network analyser to the test port to control the signal quality
- Configure the Profiler Revolution using the rotary button, see below
- Optionally: insert an SD card in the SD card slot to upload the configurations of a previous module or to copy the configuration to another module





- The power adapter can easily be replaced without disconnecting the product. To do so, open the top left plastic cover by pushing the click at the opposite side of the mains connector

## 1.6 Configuring the Profiler Revolution

### Navigating Through The Menu:

Use the Johansson rotary/push button to navigate through the menu. This is very straightforward and simple. The table below shows how the rotary/push should be used:

	<b>Push</b> the button <b>2 seconds</b> to enter the basic configuration. <b>Push</b> the button to confirm your selections.
	When <b>rotating</b> the button, you scroll through the different screens.

### Menu Overview:

◀▶	INPUT FM	INPUT V/U 1-4	OUTPUT	ADVANCED	LOAD SD PRESET	SAVE SD PRESET	EXIT
	GAIN	PRE-AMPLIFIER	LEVEL	LANGUAGE	PRESET X	CREATE PRESET	LOCK
		DC	SLOPE	REGION		DELETE ALL	NO LOCK
		ADD CHANNEL	VHF ATTN	DC VOLTAGE			
▲▼				BANDWIDTH			
				S-BAND			
				FW VERSION			
				SERIAL NUMBER			
				FORMAT CARD			

### Region/Country Settings:

**IMPORTANT! Before starting the configuration, it is advised to set the correct region or country. Unpower the unit, push the button and keep pushing the button while you repower the unit.**

Release the button when the display shows "RESET FINISHED". Now the product is reset and will ask you to enter country or region. This will amongst others determine the channel plan for VHF and UHF and the DC voltage for the inputs (12 or 24V).

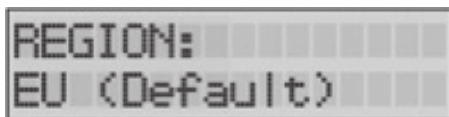

To activate the correct channel frequency plan, select the country or region where the Profiler Revolution is situated. Rotate to select and confirm by tapping the rotary button.

The default setting is Europe. The Profiler Revolution is also operational in the following countries/regions: Australia, Brazil, China, Hong Kong, Italy, New Zealand, Russia, South Africa, UK and USA.

All the following menu items can be accessed without the reset procedure.

**Push the rotary button for 2 seconds to access the menu.**

### Input Settings



Tap the rotary button to enter the INPUT FM menu. Rotate the button to navigate through the submenu.



To filter and amplify an FM signal, tap GAIN, select the gain of the input FM signal (15 to 35dB) and tap to confirm.

Note: DAB should be added via V/U input 1-4.



After INPUT FM is configured, scroll up to the top of the menu (INPUT FM), tap the rotary button and scroll right to INPUT V/U 1. Tap INPUT V/U 1 to enter the menu to configure input 1.



Rotate the rotary button to scroll down in the submenu of INPUT V/U 1.



PRE-AMPLI: The internal amplifier is by default ON, only in case of very strong incoming signals (if the strongest channel on that input is higher than 80dBµV), it is advised to switch this OFF.



DC: Decide whether the input should provide power to an external amplifier. Choose between OFF or 12 V. Note: If the external amplifier needs 24 V, you can change this in advanced settings (see further).

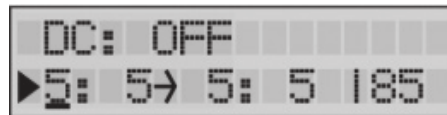

Tap Add Channel to add channel. Up to 6 channels can be added at once.



First select the starting channel (e.g. CH5) and tap to confirm. Then select the stop channel (e.g. CH7, this means that you will add 3 channels). Tap to confirm. Then you can convert them using the rotary button (e.g. CH5 to CH7 converts to CH8 to CH10) and tap to confirm.



### Some other examples:

To add CH5 and convert to CH6, select as follows: 5: 5 -> 6: 6

To add CH21-22-23 and convert to CH31-32-33, select as follows: 21: 23 -> 31:33



Note 1: The value 85dB $\mu$ V (in the bottom right corner) indicates the incoming level of the channel.

Note 2: For EU, Italy and New Zealand region, Channel 13 (230-240MHz) can be used. CH13 cannot be converted.

Note 3: A star (\*) will appear when converting to a different channel bandwidth: e.g. from a 7MHz channel to an 8 MHz channel

For optimal performance we recommend to only add single channels, unless you need to process a lot of channels.



To add another (group of) channel(s), scroll down to ADD CHANNEL and tap to confirm.

To prevent bad quality or scrambled images, make sure that only one input channel is assigned to one output channel. If 2 channels are assigned to the same output channel, a star (\*) will appear.

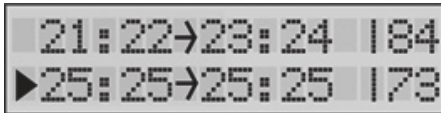

The same applies for adding multiple channels. Make sure that each output channel is selected only once.

After this, the correct LTE filter will be set for the UHF inputs (possible filters are 694MHz, 790MHz or OFF). If the channels are lower than 48, the 694MHz filter is activated. The 790MHz filter is activated for the channels lower than 60.

#### Delete a (pair of) Channel(s)

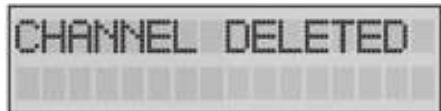

To delete a (pair of) channel(s), position the arrow on the channel and press the rotary button 3 seconds.



When you have added all the channels to INPUT V/U 1, and you want to add channels to the other inputs, scroll up to the top of the menu (to INPUT V/U 1), tap the button and scroll to the next input.

Repeat the previous steps for all input channels.

#### Output Settings

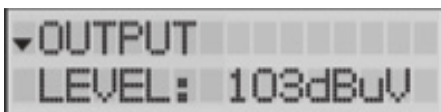

Define the OUTPUT LEVEL of the output signal. Range between 98dB $\mu$ V and 118dB $\mu$ V (default output level is 108dB $\mu$ V). Check the output via a network analyser on the -30dB test port. Note: The more channels you select, the less input power you should give (e.g. 111dB $\mu$ V for 10 channels).

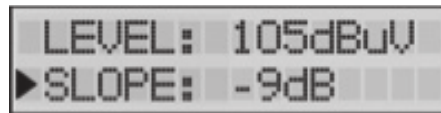

A SLOPE of up to -15dB can be set between the beginning of B111 and the end of UHF to compensate for cable losses. 0dB means all channels have the same output level (see previous display readout), -15dB means the beginning of B111 (174MHz) is 15dB weaker than the end of UHF.

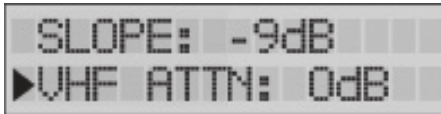

VHF ATTN: To compensate for cable losses, an attenuator of up to 15 dB can be configured to decrease the VHF (up to 300MHz) and DAB output level (compared to the UHF output level (above 300MHz)).

Note: In the OUTPUT menu, you define the output level in dB $\mu$ V of the MUX's. The Profiler Revolution has enough gain to guarantee this output level under all input conditions. In case a slope has been set, the output level indicated on the display will be the output level of the highest frequency MUX.

#### Advanced Settings

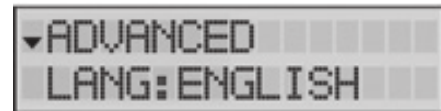

The language of the Profiler Revolution can be set to English, Italian, Spanish or French.

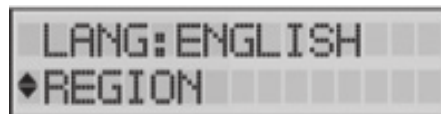

Tap REGION to check to which region/country the Profiler Revolution is set. To change the region/country, a hard reset is required. (see region/country settings)

Define DC VOLTAGE for the inputs, choose between 12V or 24V. This is a global setting for all inputs, each input can then be switched between OFF or this value. All countries are set by default on 24V, except UK which is set by default on 12V.



The filter bandwidth can be changed from -2000 kHz to 0 kHz in steps of 250 kHz. This allows you to optimize the bandwidth of your filter. For instance, a European 8 MHz channel can be changed from 6 to 8 MHz. The default setting is -750 kHz, which is an optimal setting in 95% of the cases.

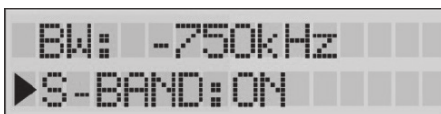

S-Band channels can be activated in Advanced Mode. By default, they are not activated.

See NOTE below for more explanation.

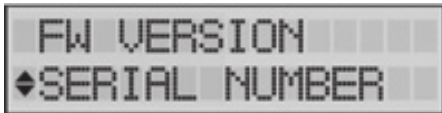

Tap FW VERSION to check the firmware version of the device. Tap SERIAL NUMBER to check the serial number of the device. To format the SD CARD, tap FORMAT CARD.

Note: You can convert any single input Channel, to any output Channel position (including output S-channels). But you can only convert a group of input channels to a group of output channels with the same channel spacing.

Some examples:

- 21:23 > 31:33 Can be converted because groups of channels have same channel spacing
- 07:07 > S15:15 Can be converted because single channel conversion
- 07:07 > S35:35 Can be converted because single channel conversion (Even though channel spacing and bandwidth is different)
- 07:08 > S35:36 Can't be converted because groups of channels have different channel spacing

### SD Card Settings

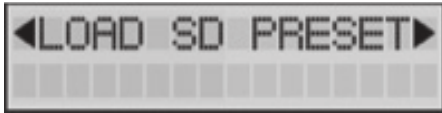

To upload settings from a SD card, tap LOAD SD PRESET. This will copy the configuration file from the SD CARD to the device.



To save the device settings on the SD CARD, go to SAVE SD PRESET and tap on CREATE PRESET.



It is possible to create multiple presets. Therefore, tap CREATE PRESET after each modification of the settings. To delete all presets, press DELETE ALL.

### Exit Settings



To avoid unauthorized people changing the settings, all Profiler products can be locked with a security code.



Select LOCK and SET LOCK CODE. When the lock code is set, the device will shut down.



When you restart the device, you will now have to enter the correct lock code. Note: If you forgot the lock code, you can always use the value 50. This master code is fixed and cannot be changed.

If you do not want to work with a lock code, go to EXIT and tap NO LOCK.

## 2. TECHNICAL SPECIFICATIONS

Inputs	4 VHF/UHF + 1FM
Outputs	1 main (FM-VHF-S-UHF) + 1 test port (-30dB)
Frequency Range	FM: 88-108MHz VHF: 174-240MHz UHF: 470-862MHz
LTE protection	Automatic selection: 694MHz, 790MHz or OFF
Input level	FM: 37-77dBµV VHF: 37*-109dBµV UHF: 37*-109dBµV
FM Output power (60dB/IM3)	113dBµV
VHF/UHF Output power (60dB/IM3)	120dBµV
VHF/UHF Output power (36dB/IM3)	131dBµV
VHF/UHF Output power with 1 MUX	118dBµV
VHF/UHF Output power with 6 MUX	114dBµV
Conversion	Yes (from any VHF-UHF channel to any VHF-S-UHF channel)
Add channels	Per 1, 2, 3, 4, 5 or 6 MUXes
Number of channels	More than 50 (32 filters)
Gain	FM: 35dB VHF: >75dB UHF: >75dB
Gain adjustment	FM: 20dB VHF/UHF: Channel AGC
General attenuator	20dB
VHF/DAB attenuator	15dB
Slope adjustment	15dB
Noise Figure	7dB
Selectivity	50dB/1MHz
Output MER	VHF: 35dB UHF: 35dB
ESD protection	All inputs
Remote voltage for preamp	12 or 24V
Remote current	100mA (total for the 4 inputs)
SD port	Yes (for copy configuration and upgrade features)
Operating temperature	-5 to +50°C
Power Supply	100-240Vac
Power consumption	15W
Dimensions	217x165x59mm
Weight	0.8kg

\* For 64QAM with code rate 3/4

### 3. BLOCK DIAGRAM

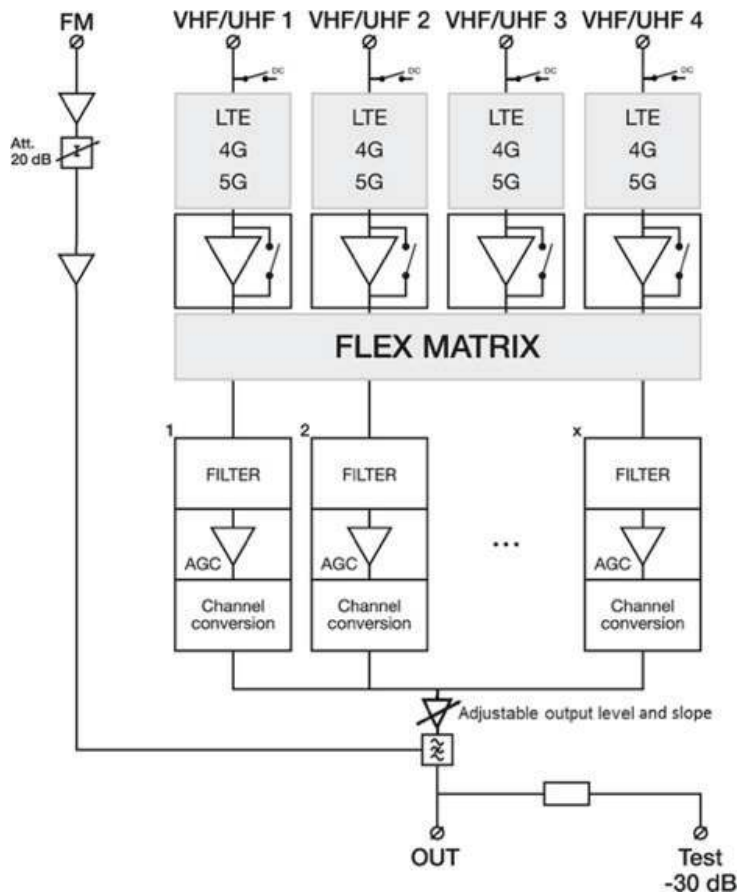

### 4. SAFETY INSTRUCTIONS

Read these instructions carefully before connecting the unit

To prevent fire, short circuit or shock hazard:

- Do not expose the unit to rain or moisture.
- Install the unit in a dry location without infiltration or condensation of water.
- Do not expose it to dripping or splashing.
- Do not place objects filled with liquids, such as vases, on the apparatus.
- If any liquid should accidentally fall into the cabinet, disconnect the power plug.

To avoid any risk of overheating:

- Install the unit in a well aired location and keep a minimum distance of 15 cm around the apparatus for sufficient ventilation
- Do not place any items such as newspapers, tablecloths, curtains, on the unit that might cover the ventilation holes.
- Do not place any naked flame sources, such as lighted candles, on the apparatus
- Do not install the product in a dusty place
- Use the apparatus only in moderate climates (not in tropical climates)
- Respect the minimum and maximum temperature specifications

To avoid any risk of electrical shocks:

- Connect apparatus only to socket with protective earth connection.
- The mains plug shall remain readily operable
- Pull out power plug to make the different connections of cables
- To avoid electrical shock, do not open the housing of adapter.

### Maintenance

- Only use a dry soft cloth to clean the cabinet
- Do not use solvent
- For repairing and servicing refer to qualified personnel

Dispose according to your local authority's recycling processes

### 5. CONDITIONS OF WARRANTY

Matchmaster warrants the product as being free from defects in material and workmanship for a period of 24 months starting from the date of production indicated on it. See note below.

If during this period of warranty the product proves defective, under normal use, due to defective materials or workmanship, Matchmaster, at its sole option, will repair or replace the product. Return the product to your local dealer for reparation.

THE WARRANTY IS APPLIED ONLY FOR DEFECTS IN MATERIAL AND WORKMANSHIP AND DOES NOT COVER DAMAGE RESULTING FROM:

- Misuse or use of the product out of its specifications,
- Installation or use in a manner inconsistent with the technical or safety standards in force in the country where the product is used,
- Use of non-suitable accessories (power supply, adapters, etc)
- Installation in a defect system,
- External cause beyond the control of Matchmaster such as drop, accidents, lightning, water, fire, improper ventilation etc

THE WARRANTY IS NOT APPLIED IF

- Production date or serial number on the product is illegible, altered, deleted or removed.
- The product has been opened or repaired by a non-authorized person.

Note: Date of production can be found in the product's serial number code. The format will either be "YEAR W WEEK" (e.g., 2017W32 = year 2017 week 32) or "YYWW" (e.g., 1732 = year 2017 week 32).

