



360 Rotation Bumper Car (12V) 2 Speed (Kidzone App)

060-ROT-16

Owner's Manual

*Product appearance and colors may vary from the photo.

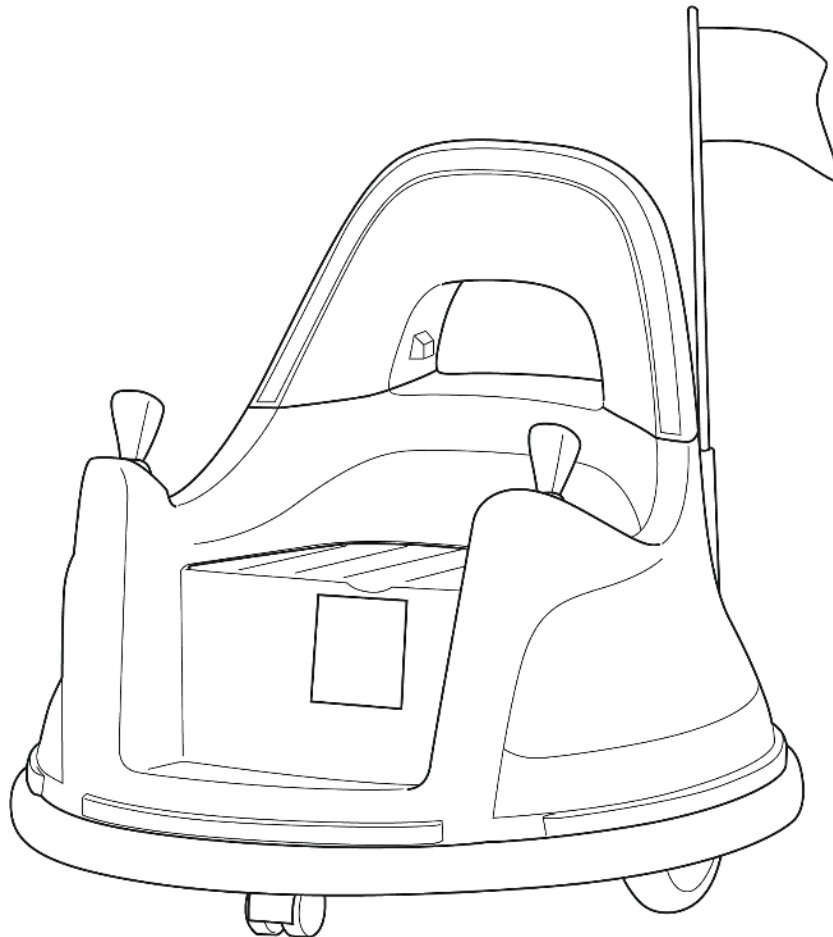

Welcome to Kidzone's world of ride-ons where fun and adventure await! Little ones have a blast riding our toys at home, in the park, or on the sidewalk.

At Kidzone, our goal is to make playtime more fun for kiddos, while ensuring comfort and safety. Our ride-ons help create joyful moments for the entire family that'll turn into forever memories!

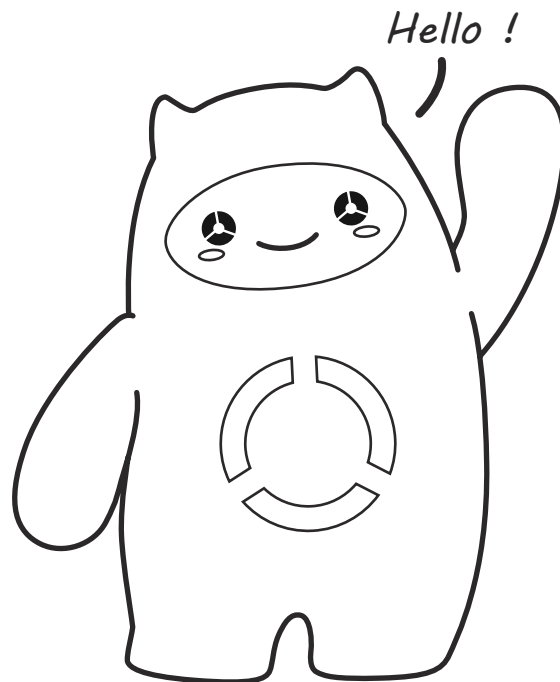

 **ATTENTION**

This owner's manual contains important safety, performance, and maintenance information.

Read the manual before allowing your child to ride on the product.

Keep this manual for future reference.

Table of Contents

04	Safety Instruction
06	Product Specification
07	Parts and Accessories
08	Assembly Instruction
11	User's Instruction
12	User's Instruction Control Panel
14	User's Instruction Remote Control
16	User's Instruction Charging
17	Care and Maintenance
18	Troubleshooting
20	Warrenty Information

Safety Instruction



When using electrical product, basic safety precaution should always be followed including the following:

Failure to follow the safety instructions may result in property damage, serious injury or death.

WARNING

DISCLAIMER

- Manufacturer and seller expressly disclaim any and all liability for personal injury, property damage or losses, whether direct, indirect, or incidental, resulting from the incorrect attachment, improper use, inadequate maintenance, unapproved modification, or neglect of this product.

BASIC SAFETY

- **This product is only designed to be used by children age 18 - 72 months.**
- **Do not exceed the maximum weight capacity of 66 lb / 30 kg.**
- **Adult and/or supervisors must instruct the user all common safety rules and safe practice.**
- **This product should be operate on a flat and smooth surface. Do not use this product in any slippery conditions including rain, snow, and ice, or at any potential dangerous places.**
- **To reduce the risk of injury, adult supervision is required. Never use in roadways, near motor vehicles, on or near steep inclines or steps, swimming pools or other bodies of water; always wear shoes, and never allow more than 1 rider.**
- **RISK OF FIRE. Do not bypass. Replace only with original size and type.**
- **Do not use this product as a traffic tool.**
- **Never leave children unattended with the ride-on toy. Close supervision is necessary when your children is using the product.**
- **If necessary, adult and/or supervisors should be responsible for setting up gate and barriers to ensure a safe environment for child rider.**
- **Be aware and alert children that hands, legs, hair, clothings, and loose items can potentially get caught in moving parts. Avoid placing body parts on moving parts and do not wear loose clothing while using the ride-on toy.**
- **Avoid using this product in tight environment to prevent damage to the product or injury to the user.**
- **This product does not equip with brakes. Do not use this product in areas that requires active braking to prevent possible rolls, crashes, or bodily injury.**
- **Do not use this product in the dark. Only operate this product during daytime or in a well lit area.**
- **Avoid continuously hitting into obstacle to prevent overheating or damaging the motor. Drive away or remove obstacle as soon as possible.**
- **For your child's safety, make sure the seatbelt is securely fasten and the rider is wearing personal protective equipment, such as helmet, when operating this product.**
- **Friction Hazards! Do not operate this product on carpets or rugs, it may cause burn or fire if over run or over spin, This product has automatic cut-off function if overcurrent, overloaded, or operated incorrectly, wait for 10 - 15 seconds to reactivate this product automatically.**

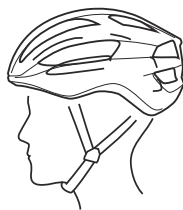

Correct Fitting

Make sure the helmet covers your forehead.



Incorrect Fitting

Forehead is exposed and vulnerable to injury.

CAUTION

Failure to follow these instruction may result in permanent damage to the product or parts.

CELL BATTERY AND RECHARGEABLE BATTERY HANDLING

- Do not mix old and new batteries.
- Do not mix alkaline, standard (carbon-zinc), or re-chargeable batteries.
- Permanent damage to the battery may occur if it is completely drained. Do not let the battery to drain completely.
- On average, you will need to charge the battery for 8 - 12 hours. Do not charge the battery for more than 20 hours. Failure to charge the battery as directed could cause permanent damage to the battery and void the warranty.
- Only an adult who has read and underrstands the safety instruction should handle, charge, and recharge the battery.
- Disconnect the battery if not used for a long period of time.

WARNING

Failure to follow these instruction may result in bodily harm, serious injury, or death.

CHOCKING HAZARD, ASSEMBLY WARNING

- This product contains small parts before assembly. Keep children away when assembling the ride-on toy. The assembly should only performed by an adult.
- Remove and dispose all protective materials, plastic bag, and packaging before assembly.
- This product should not be used by children under the age of 18 months old.

ELECTRIC SHOCK, FIRE HAZARD, FLAMMABLE AND EXPLOSIVE WARNING

- To protect against electrical shock, do not let cord, charger, transformer, battery or the product contact with water or other liquid.
- Do not drive the vehicle into any puddle or contact with any liquid to prevent electrical shock.
- Do not change, modify, or add any electrical wiring on the product. Alternations could potentially cause short circuit, a fire, or irreversible damage to the electrical system.
- Only use charger and battery provided or recommended by the manufacturer. Using the wrong type of battery or charger could cause a fire and potentially property damage and serious injury.
- Check the battery, charger, and connectors for any sign of excessive wear or damage each time you charge the battery. Do not use the charger or the battery if damages are present. Change and replace damage part before use.
- Do not lift or carry the battery by the wires or charger. You might damage the wires and case electric shock or fire.
- Do not charge more than 20 hours. You might over heat the battery and cause damage or a fire.

CORROSIVE CHEMICAL, PRODUCT MATERIAL WARNING

- Contact or exposure to battery leakage may cause serious injury. If contact or exposure occurs to the skin or in the eyes, or if the chemical is swallowed, call medical emergency immediately.
- Battery posts, terminals, and related accessories contain lead and lead compounds which are toxic and corrosive. Never open the battery.

Product Specification



Model no.	060-ROT-16
Battery	12 v
Charger output	DC 12 v
Batter Charge Time	8 - 12 hours
Speed	0.75 - 1.3 mph (1.2 - 2.1 km/h)
Suitable Age	18 - 72 months
Maximum User Weight	66 lb / 30 kg

Parts and Accessories

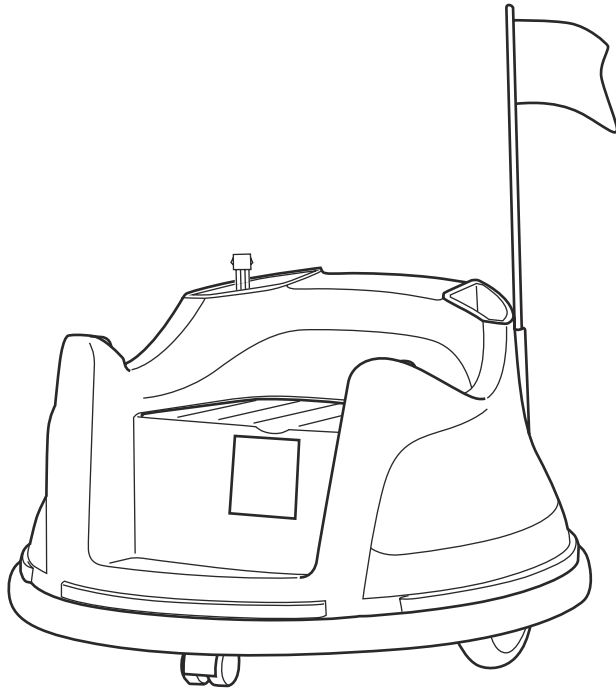

A. Car Body
1x

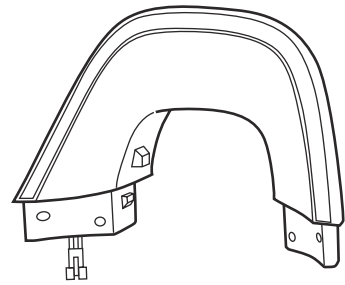

B. Backrest
1x

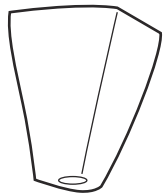

C. Joystick & cap
2x

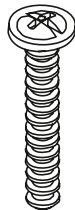

D. M3.5 x 20 Screws
2x

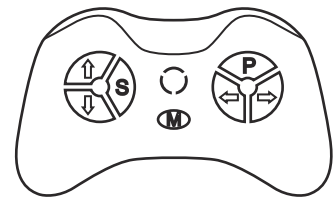

E. Remote Control
1x

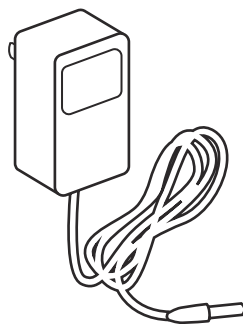

F. Charger
1x

Assembly Instruction



WARNING

**This product should only be assembled by an adult.
Children can be harmed by small parts, sharp edges and points or by electrical items. Care should be taken when unpacking and assembling the vehicle.**

Tools required (not included)



1

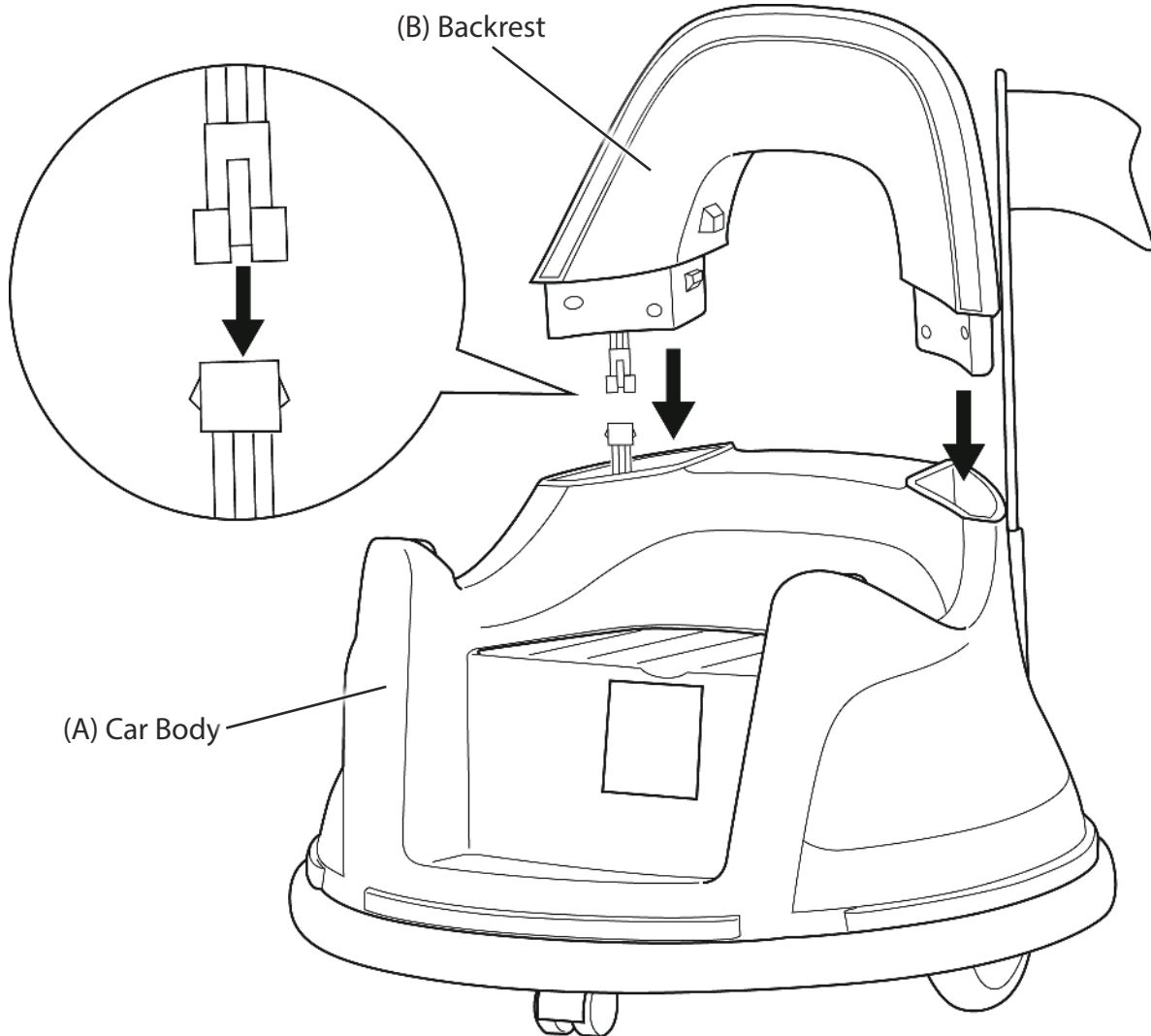

- Connect the electrical wire from the backrest to the main car body by plugging the electrical connectors.
- Insert the backrest to the main car body.



Assembly Instruction

2

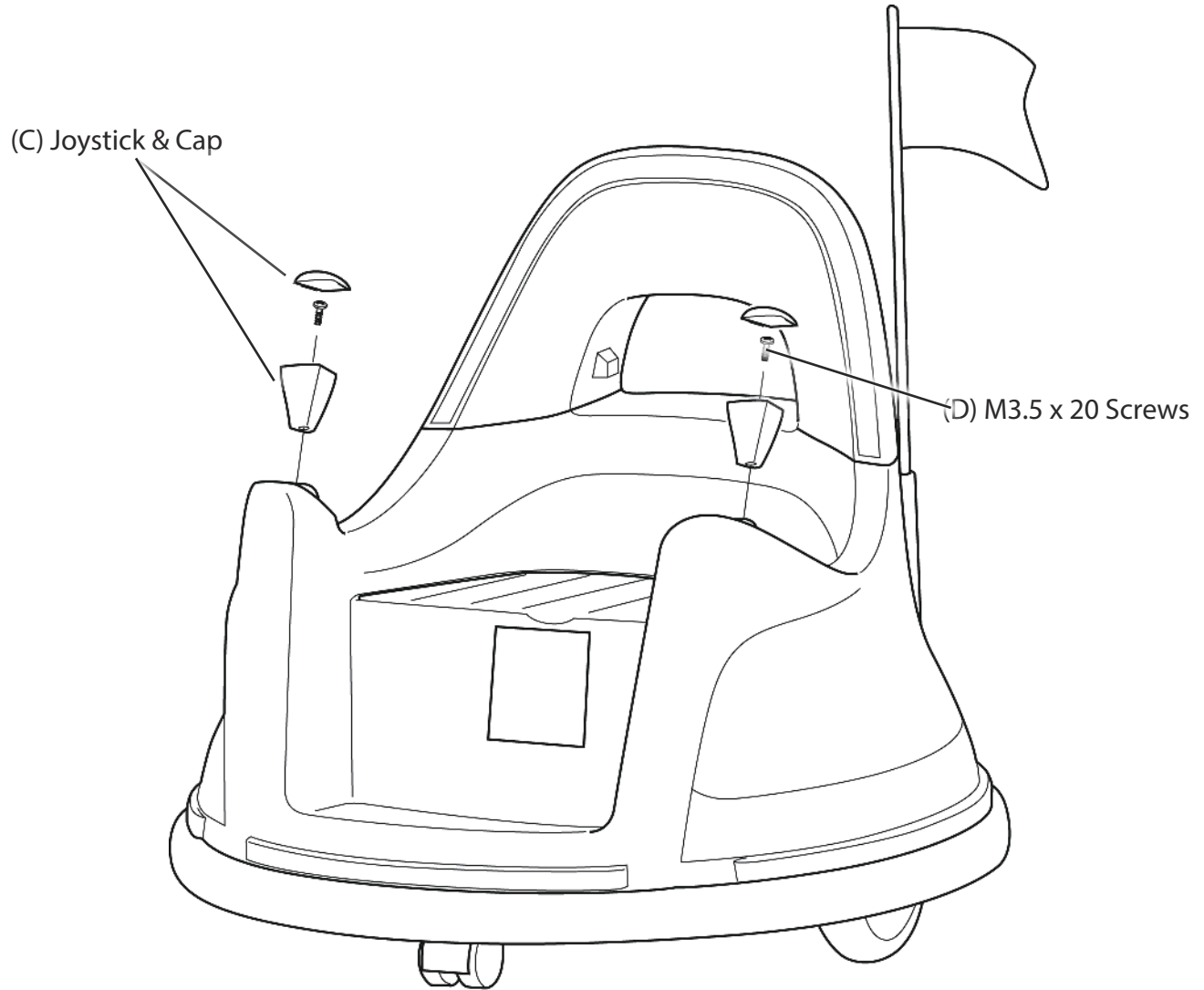

- Attach the joysticks to the car body with the provided screws.
- Slip the joystick cap on top of the joystick.

Assembly Instruction



3

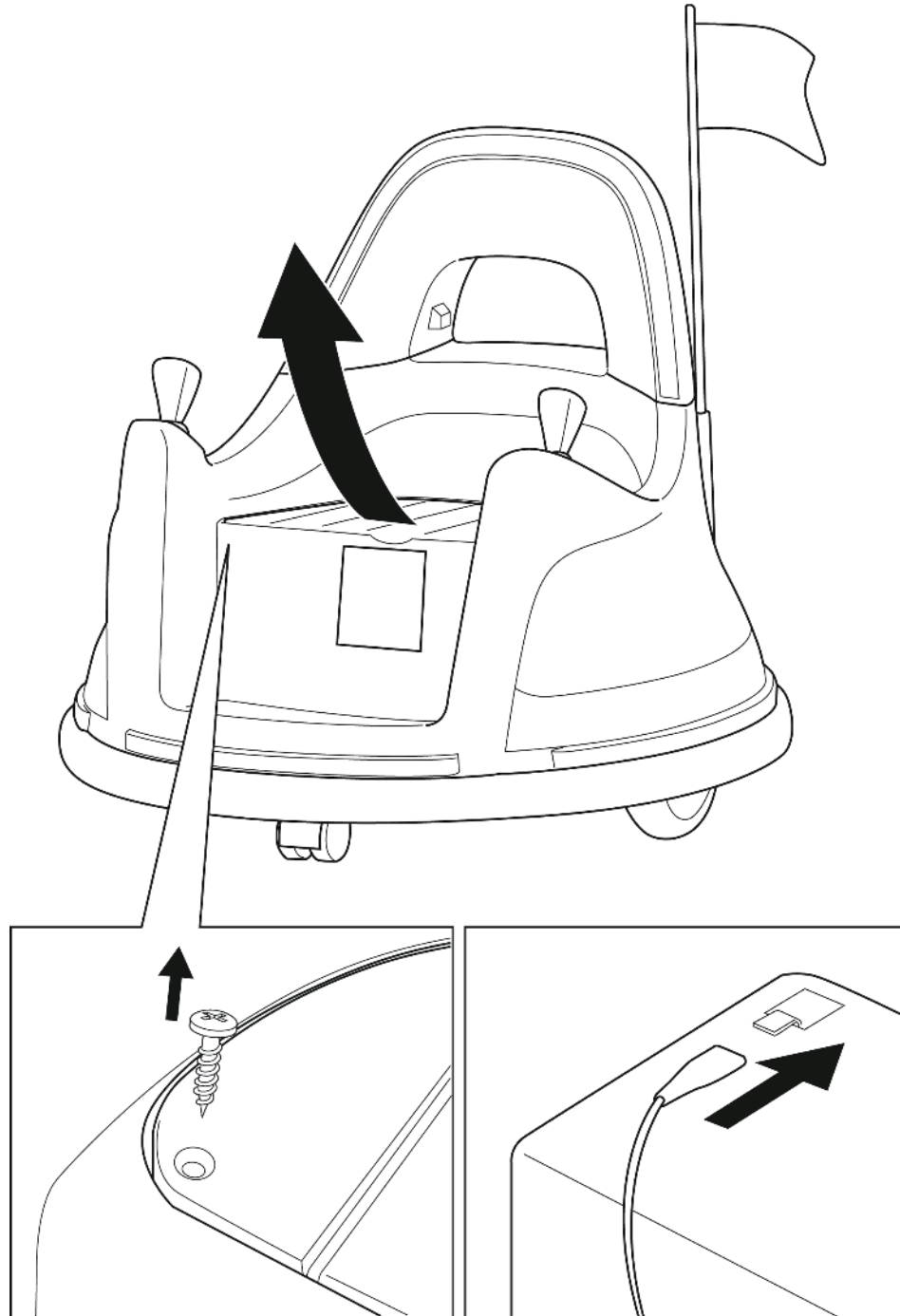

- Temporary remove the seat and connect the electrical wire from the car to the battery, then replace the seat in its original position.

ATTENTION



**This product is packed with the battery disconnected.
Connect the battery before use.**



User's Instruction

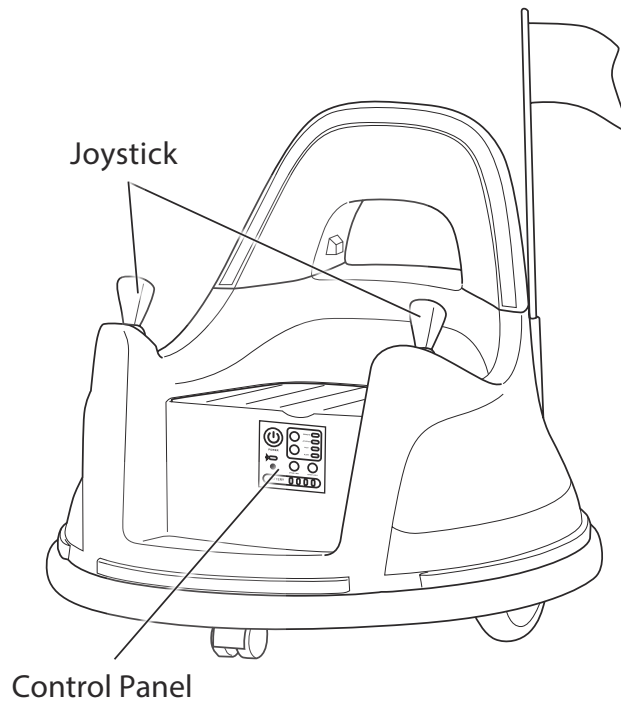

Control the vehicle

Control Panel

Control Panel

Control the functions of the car. (See page 12 for detail instruction)

Joystick

Push / Pull the joysticks to move the car forward, backward, or rotate the car.

Forward

Push both control sticks forward at the same time.

Backward

Pull both control sticks backward at the same time.

Left turn the vehicle forward

Push the right control stick forward.

Right turn the vehicle forward

Push the left control stick forward.

Left turn the vehicle backward

Pull the right control stick backward.

Right turn the vehicle backward

Pull the left control stick backward.

Left spin the vehicle

Pull the left control stick backward and push the right control stick forward at the same time.

Right spin the vehicle

Push the left control stick forward and pull the right control stick backward at the same time.

Stop the vehicle

Release both control sticks and returns them to the center position.

CAUTION

**Do not change direction until the vehicle comes to a complete stop.
Sudden change in direction may result in permanent damage to the motor.**

User's Instruction (Control Panel)

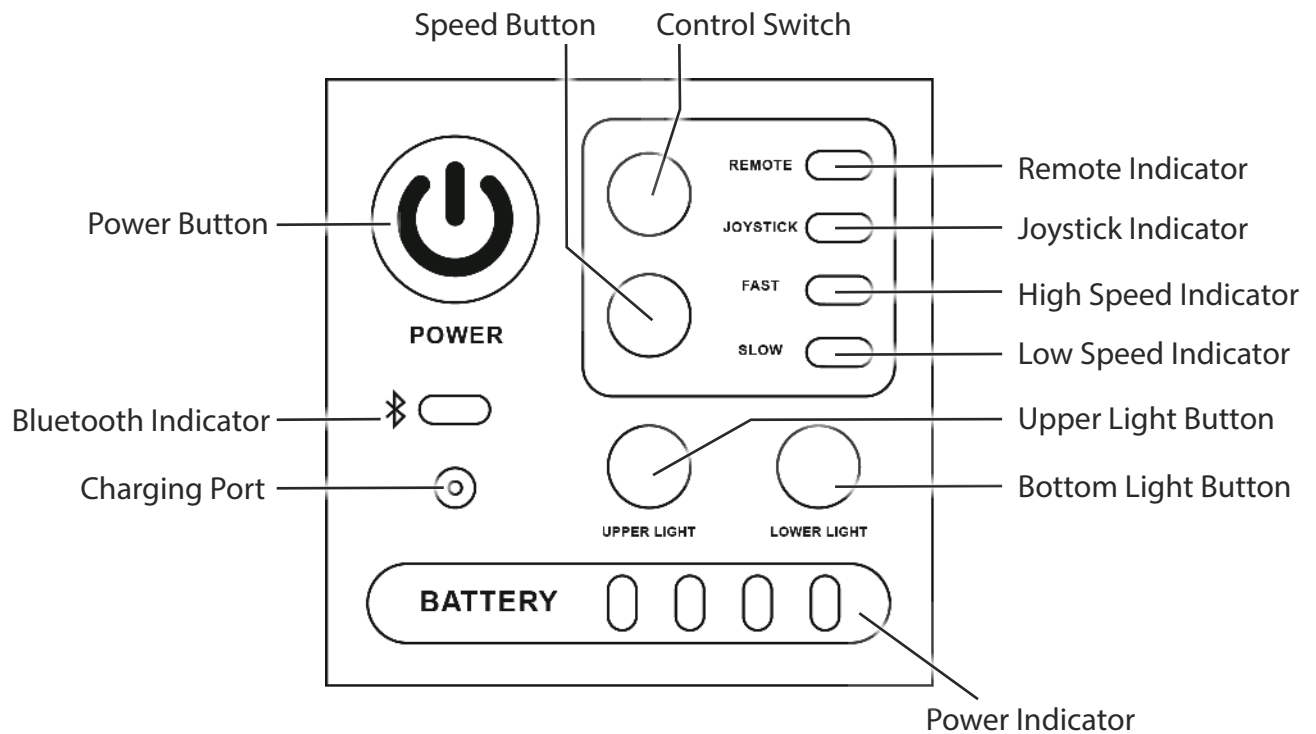

Control Panel

Power Button

Press the power button to ON or OFF the vehicle.

Speed Button

Press the speed button to switch between high and low speed.

Control Button

Press the control button to switch between remote control input and joystick input.

Remote Indicator

The remote indicator will light up when the remote control is chosen as the preferred control input .

Joystick Indicator

The joystick indicator will light up when the joystick is chosen as the preferred control input.

High Speed Indicator

High speed indicator will light up when the vehicle is in high speed mode.

Low Speed Indicator

Low Speed Indicator will light up when the vehicle is in low speed mode.



User Instruction (Control Panel)

Upper Light Button

Press the upper light button to turn on the light on the back rest.

Continue pressing the upper light button to select different light effects.

Light effects are in the following sequence: Red light, green light, blue light, all light on, red green blue rotation, off)

Bottom Light Button

Press the bottom light button to turn on the light on the car body.

Continue pressing the bottom light button to select different light effects.

Light effects are in the following sequence: Red light, green light, blue light, all light on, red green blue rotation, off)

Power Indicator

Indicator shows the estimate power level of the battery.

Charging Port

Plug the charging cable to the charging port to charge the battery. (See page 16)

Bluetooth Indicator

When turning on the vehicle, the indicator light stays OFF. After a successful connection with a mobile device, the indicator light will light up.

User Instruction (Remote Control)

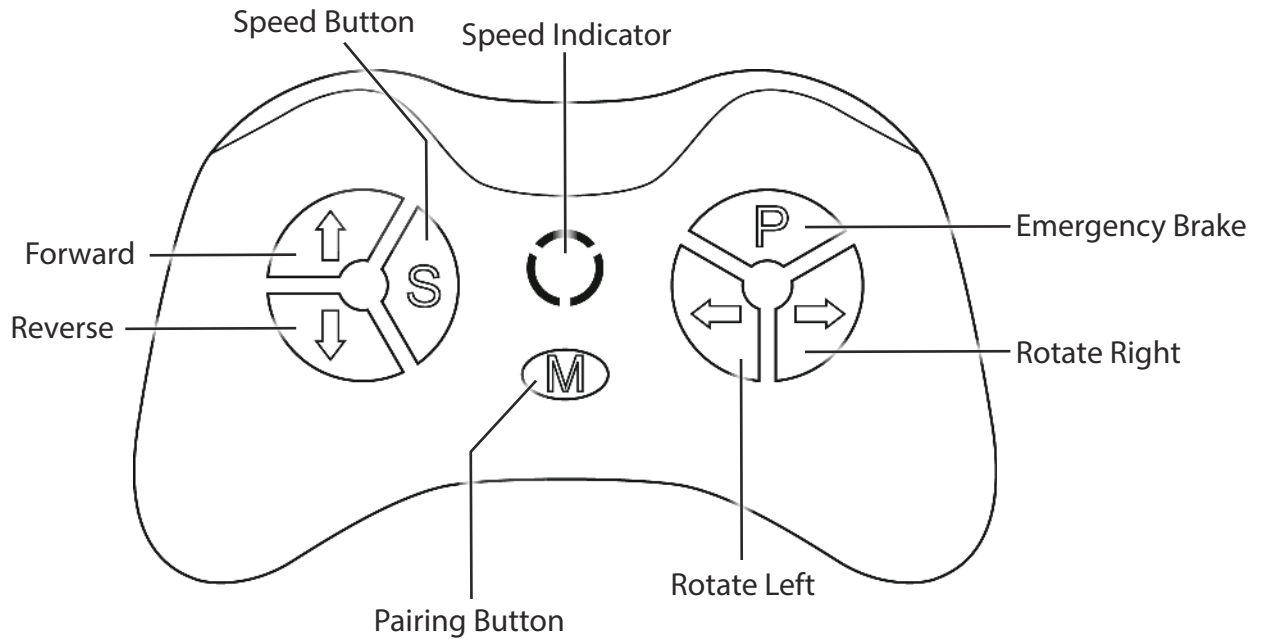

Using the remote control

The remote control should only be used by an adult.

Pairing the remote control

The remote control needs pairing for the first time usage or after replacing the battery.

- Insert batteries into the remote control. (see page 15)
- Press the "M" button (pairing button) for 2 -4 seconds, the indicator will flash.
- Turn on the power of the vehicle, the indicator should change to solid light, then frequency bind succeed. If failed to pair, remove and replace the battery from the remote control and repeat the pairing steps.

Control the Vehicle

- Press the control button on the vehicle's control panel and choose remote control as the preferred input.
- Press the directional buttons to move the vehicle.
- Press the "P" button to enable emergency brake. All running function will be disabled once the button is pressed. Press the "P" button again to enable other functions.
- Press the "S" button to switch between high and low speed

The remote control will go into power saving mode if not used after 10 seconds.



User Instruction (Remote Control)

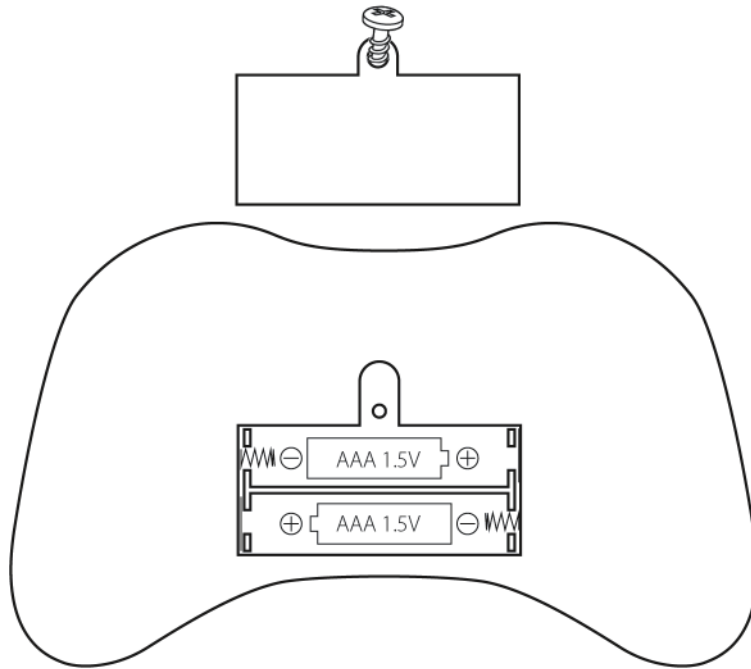

Changing the remote control battery

The remote control requires 2 AAA 1.5v batteries. (not included)

- Remove the cover on the back side of the remote control.
- Replace old batteries with 2 new AAA 1.5v batteries in correct polarity.
- Put the cover back in place and secure with the screw.

WARNING

The battery should only be changed by an adult.

Do not mix old and new batteries.

Do not mix alkaline, standard (carbon-zinc), or re-chargeable batteries.

User Instruction (Charging)

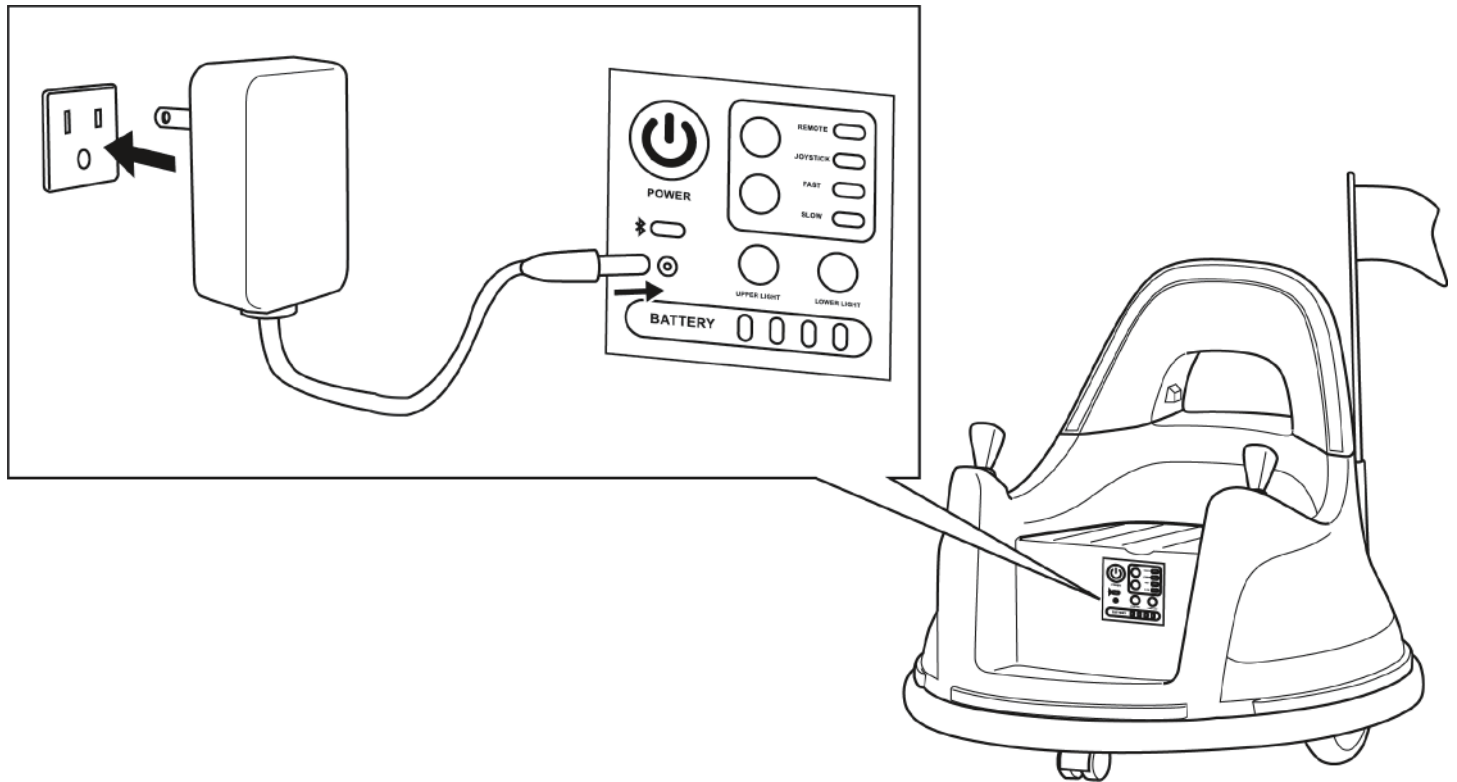

⚠ WARNING

The battery should only be charged by an adult.

Charging the battery

1. Connect the charger to the charging port.
 2. Plug the charger into a wall outlet. The battery will start charging.
 3. The charger indicator turns red when charging, turns green after charging completed.
- The vehicle must be OFF when charging.
 - Recharge the battery if the vehicle operates slowly.
 - DO NOT operate the vehicle charging.

NOTE:

- Damage to the battery may occur if it is completely drained.
- Charge the battery for about 8 - 12 hours.
- Do not charge the battery for more than 20 hours.
- **Charge the battery at least once a month even if not operating the vehicle for a long time to maximize the battery life.**
- Do not charge or store the battery upside down.
- Keep the charger and battery away from flames, sparks, or any flammables.

Care and Maintenance



- Check the product regularly and make sure there is no missing or loose parts. Re-tighten any loose parts if necessary.
- Make sure there is no cracked or broken plastic parts.
- Store the product away from heat source when not using, cover it with a tarp and away from wet weather.
- Turn off the product and disconnect the battery if the product is not use for a long period of time.
- Clean the vehicle with a cloth. Use a non-wax furniture polish to restore shine to plastic parts. Do not use abrasive cleaner.
- Do not wash the product with a hose or immerse any parts in water or other liquid.
- Occasionally use lightweight oil to lubricate moving parts.
- Regularly charge the battery to prolong the battery life.
- Do not store the product near heat source, such as stoves and heaters. Plastic parts may melt under high temperature.

Troubleshooting



Problem	Possible Reason	Solution
Vehicle does not move	Low Battery	Fully charge the battery
	Fuse Protection	Fuse will reset automatically in about 10-15 seconds
	Disconnected / Badly connected battery	Reconnect the battery
	Failed battery / engine	Contact Customer Service
Vehicle does not run very long	Low Battery	Fully charge the battery
	Old / Damaged Battery	Replace battery if necessary
Vehicle runs very slow	Low Battery	Fully charge the battery
	Old Battery	Replace battery if necessary
	Vehicle is overloaded	Make sure user's weight is under 66 lb / 30 kg
	Vehicle is being used in harsh environment	Avoid using the vehicle in harsh environment

Troubleshooting



Problem	Possible Reason	Solution
Vehicle needs a push to go forward	Poor wire connection	Check if the battery connectors are firmly connected. Contact Customer service if necessary
	"Dead spot" on motor	Contact customer service
Loud grinding sound or clicking sound from the motor or gear box	Damaged motor or gear box	Contact customer service
Battery does not charge	Disconnected / Badly connected battery	Reconnect the battery
	Disconnected / Badly connected charger	Make sure the charger is firmly plugged into the power source and connected to the charging port
	Charger not working	Contact customer service
Vehicle does not stop	Damaged equipment	Contact customer service
Charger becomes warm during charging	Normal	N/A

Limited Term Warranty (One Year from Date of Purchase)

WARRANTY TERMS

KIDZONE warrants that its merchandise are free from manufacturing defects (workmanship and/or material) and will either give credit or replace defective parts for a period of up to one (1) year from the date of purchase in accordance with the conditions set forth below. If a manufacturing defect is found, KIDZONE should be notified promptly of the defect and supplied a copy of the invoice and delivery ticket. Inspection by a KIDZONE employee or representative may be necessary to verify that a manufacturing defect exists, or you may be required to submit samples to KIDZONE along with a digital image of the defects. If replacement is required in accordance with this warranty and the defective material or merchandise has been discontinued or unavailable, KIDZONE reserves the right to select and supply similar merchandise or offer full credit for the merchandise; otherwise the same material or merchandise will be supplied for replacement purposes. This warranty is made solely to the retailer and is not transferable under any circumstances. It is the retailer's responsibility to contact KIDZONE with a claim. We will not handle claims from consumers directly; all requests must go through the retailer who sold the merchandise to the consumer. We advise all retailers to retain invoices for a minimum of one (1) year for warranty purposes. This warranty supersedes and replaces all implied warranties of merchantability and use for particular purpose. No representative, employee, agent or any other person is authorized to assume for KIDZONE any additional liability or responsibility in connection with KIDZONE's merchandise except as described above. Implied warranties or merchantability and fitness of the merchandise are limited to a period of one (1) year from the date of purchase. In no event shall KIDZONE be liable for indirect, consequential or incidental damages of any kind.

ADDITIONAL CONDITIONS

THE FOLLOWING EXAMPLES ARE NOT MANUFACTURER'S DEFECTS:

- Colors may vary slightly from the photo because of photography and printing tolerances.
- Sizes stated in U.S. standard measurements may vary slightly due to product are manufactured using the metric system.
- No returns for buyer's remorse.
- No returns - other than stated above will be accepted.

ADDITIONAL CONDITIONS

WARRANT IS VOID FOR ANY OF THE FOLLOWING CONDITIONS:

1. Improper maintenance or improper use resulting in damage.
2. Any product modifications by dealer, consumer, or other parties not authorized by KIDZONE will void this warranty.
3. Floor samples sold or products designated "AS IS" at the time of purchase are not covered by the warranty
4. Warranty does not cover minor variations or differences between floor samples or printed illustrations and your product.
5. Cost of packaging and shipping to and from KIDZONE is not covered by the warranty unless expressly arranged by KIDZONE.
6. This warranty covers only articles of appliances intended for residential use only, does not cover any industrial, commercial, institutional or Rental use.
7. Dissatisfaction due to buyer's remorse.
8. Normal wear and tear.
9. Damages incurred during transportation.
10. Damages incurred during assembling or maintenance.
11. Damage incurred by accidents or abuse.



Controller:
Model: TX19
FCC ID: 2AJ2H-WYTX19
Vehicle:
Model: 060-ROT-16
FCC ID:2BBEC060-ROT-16

This device complies with part 15 of the FCC rules. Operation is subject to the following two conditions:

- (1) This device may not cause harmful interference, and
- (2) this device must accept any interference received, including interference that may cause undesired operation.

NOTE: This equipment has been tested and found to comply with the limits for a Class B digital device, pursuant to Part 15 of the FCC Rules. These limits are designed to provide reasonable protection against harmful interference in a residential installation. This equipment generates, uses and can radiate radio frequency energy and, if not installed and used in accordance with the instructions, may cause harmful interference to radio communications. However, there is no guarantee that interference will not occur in a particular installation. If this equipment does cause harmful interference to radio or television reception, which can be determined by turning the equipment off and on, the user is encouraged to try to correct the interference by one or more of the following measures:

- Reorient or relocate the receiving antenna.
- Increase the separation between the equipment and receiver.
- Connect the equipment into an outlet on a circuit different from that to which the receiver is connected.
- Consult the dealer or an experienced radio/TV technician for help.

Caution: Changes or modifications not expressly approved by the party responsible for compliance could void the user's authority to operate the equipment.

This Product conforms to toy safety standards CPSIA and ASTM-F963.

Importer: Align Inc.

Importer Address: 19301 E Walnut Dr. N., City of Industry, CA 91748 United States

Importer Tel: 1-800-946-6151



© All copyright of this document belongs to KIDZONE.
This document may not be printed, translated, reproduced, or distributed in whole or in part without written permission from KIDZONE.



kidzone[®]

www.kidzonetoy.com

