

allen + roth®

ALLEN + ROTH and logo design are trademarks or registered trademarks of LF, LLC. All rights reserved.



ITEM #2808392
AVENT FERRY
2-CT CHAIRS
MODEL #FRS81098RS

Thank you for purchasing this allen + roth product. We've created these easy-to-follow instructions to ensure you spend your time enjoying the product instead of putting it together. But, if you need more information than what is provided here, please visit Lowes.com, search the item number and refer to the Guides & Documents tab on the product's page.

If you have any questions or problems, please call our customer service department at 1-866-439-9800, 8 a.m. - 8 p.m., EST, Monday - Sunday. You could also contact us at partsplus@lowes.com or visit www.lowespartsplus.com.

RR20327

PREPARATION

Before beginning assembly of product, make sure all parts are present. Compare parts with package contents list and hardware contents list. If any part is missing or damaged, do not attempt to assemble the product.

Estimated Assembly Time: 15 minutes

NO ADDITIONAL TOOLS REQUIRED

FEELING CONFIDENT? START YOUR NEXT PROJECT

• Visit lowes.com for more information.

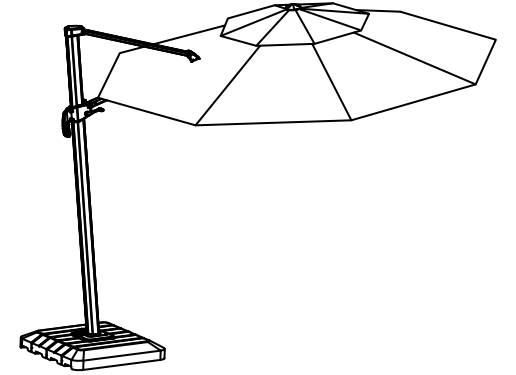
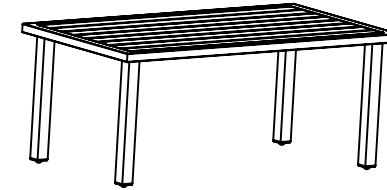
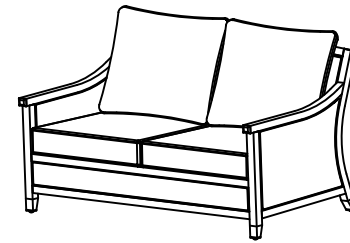

Printed in China

CARE AND MAINTENANCE

- Before using, clean the product completely with a soft, dry towel.
- When not in use, wipe free of any dirt or loose objects, wash with a mild solution of soap and water, rinse and dry completely.
- Do not use strong detergents or abrasive cleaners.
- Store the product in a cool, dry location away from sunlight.

WARRANTY

This warranty is extended to the original purchaser and applies to defects in materials and workmanship of your patio furniture provided your furniture is maintained with care and used only for personal, residential purposes.

Frames are warranted to be free from defects in material or workmanship for a period of three (3) years.

Cushions, straps and/or wicker weaves are covered for a period of three (3) years against defects in material or workmanship.

SAFETY INFORMATION

CAUTION

- Use and carry this item with care and apply touch-up paint (not included) when necessary.
- This outdoor furniture is designed and made for personal non-commercial use.
- This item should not be used as a toy or a tool.
- Do not locate the product near any heat source.

SAFETY INFORMATION

Please read and understand this entire manual before attempting to assemble, operate or install the product.

WARNING: MAXIMUM WEIGHT CAPACITY: 250 LBS PER CHAIR.

Not intended for commercial use. Proper use of this chair is for single person seating only. Do not stand on chair or use as a step ladder. For optimum safety, use on even surface only! Improper use of this product or failure to use or assemble as directed may result in injury.

WARNING

- Tighten each bolt firmly and properly. Do not completely tighten screws until all screws are started.
- Some parts may contain sharp edges. Wear protective gloves as necessary.
- Children under the age of 16 should not be engaged in the assembly, removal or disassembly of the product.
- Children under the age of 10 should be supervised by a competent adult while using this furniture.
- Please keep children out of the assembly area during assembly.
- This set is heavy, and may require two adults for safe assembly.
- Never use this product as a support. Do not shake, lean, or climb on the product at any time.

CAUTION

- Do not overtighten any of the bolts as this may damage the threads.
- Repeated assembly can weaken the locking ability of the washers.
- Periodically check all bolted connections on the furniture to make sure they are tight and secure.
- Retain these instructions for future reference.
- Paint on this product might peel off if it is hit or used improperly.

PACKAGE CONTENTS

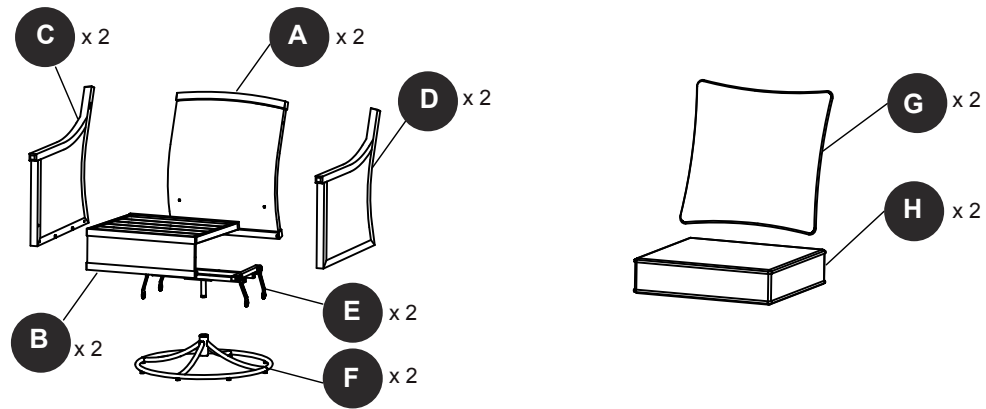

HARDWARE CONTENTS

Note: Hardware not shown actual size.

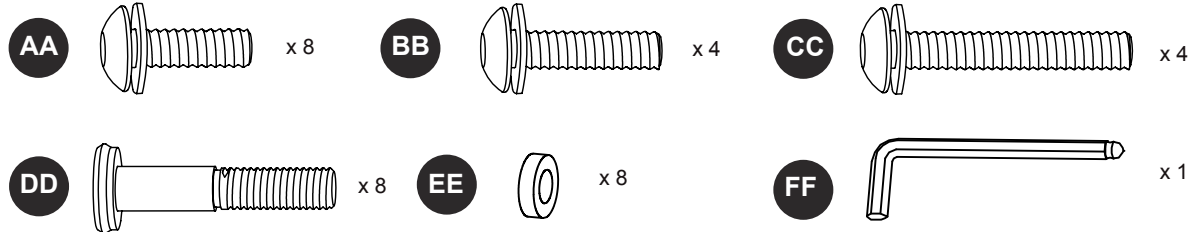

INSTALLATION OVERVIEW

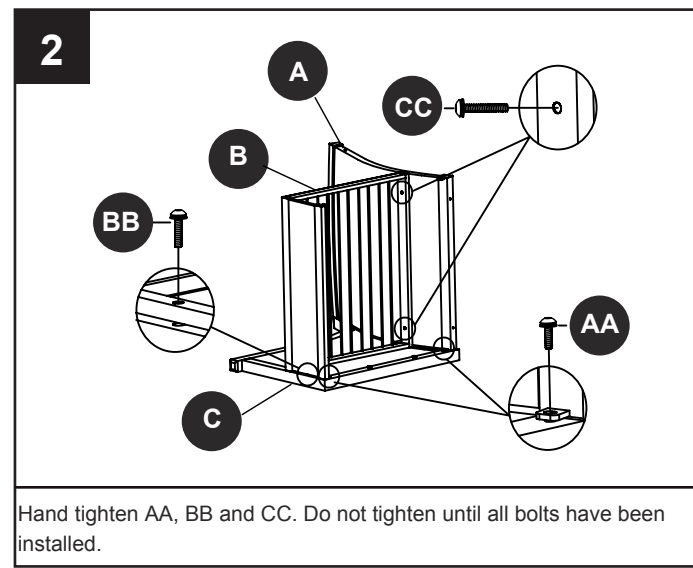
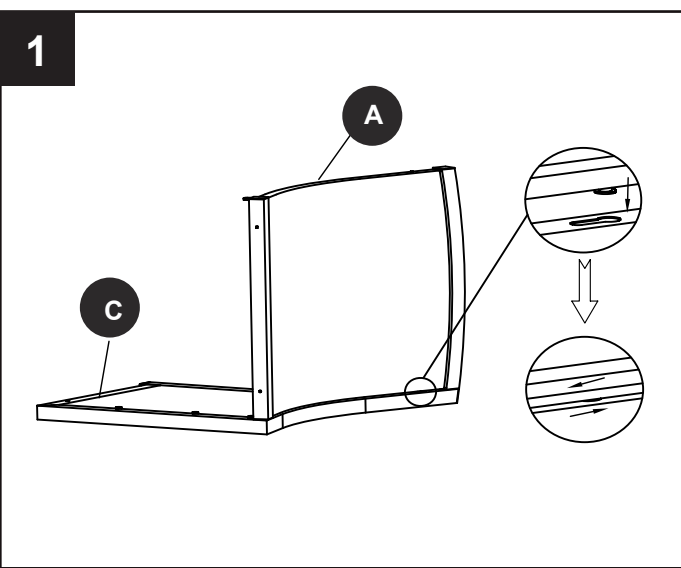

INSTALLATION OVERVIEW

