

PIKE
User Manual



Web:www.lightsky.com.cn

Tel: 0086-20-61828288

Fax:0086-20-61828188 Pc:510820

E-mail: flydragon@lightsky.com.cn

Address: No. 4, Jingneng Road 1,
Huadu District, Guangzhou, China



LiGHT SKY



WWW.LIGHTSKY.COM.CN

CONTENTS

1、 Safety Instructions	2
2、 Technical Specifications	5
2.1、 Attachment And Size	7
2.2、 Lamp Splicing	8
3、 Connection and Control	9
3.1、 Power Supply Connection	9
3.2、 DMX 512 Connection	10
3.3、 Control Panel	11
4、 How To Set The Unit	12
4.1、 Main Function	12
5、 Channel Setting	15
5. 1、 Address Setting	15
5.2、 Block Distribution	16
5. 3、 DMX 512 Configuration	17
6、 Electrical Connection Diagram	30
7、 Troubleshooting	31
8、 Fixture Cleaning	32
9、 Duty Exonerative and Copyright Protectio	32

Congratulations on choosing our company product! We thank you for your custom.

- ◆ Please keep in mind that this product, like other products of the company, adheres to the concept of people-oriented design and manufacture, and takes product quality as the foundation.
- ◆ We put the interests of customers first, and do our best to meet customer requirements.
- ◆ Please read this instruction manual carefully and keep it for future reference. In the case of fully understanding the product information, strictly abide by the Use the instruction manual to ensure that the product is installed, used and serviced correctly and safely.
- ◆ Our company is not responsible for any damage to lamps or other performance due to personal failure to follow the instructions during installation, use and maintenance.responsibility.
- ◆ Our company reserves the right to modify the manual at any time and without prior notice.

1.Safety Instructions



















Please read the instruction carefully which includes important information about the installation, usage and maintenance.

WARNING

Please keep this User Manual for future consultation. If you sell the unit to another user, be sure that they also receive this manual.

The following symbols are used to identify important safety information on the product and in this manual:

Important:

Damages caused by the disregard of this user manual are not subject to warranty.

The dealer will not accept liability for any resulting defects or problems.

— Unpack and check carefully to ensure that there is no transportation damage before using the unit.

— Do install and operate by qualified operator.

— The light source in this luminaire should be replaced by the manufacturer or its service agent or a similarly qualified person, always cut off the power supply before replacing the light source.

— Do not allow children to operate the fixture.

— Use safety chain when fixing the unit. Handle the unit by carrying its base instead of head only.

- The unit must be installed in a location with adequate ventilation, at least 50cm from adjacent surfaces.
- Be sure that no ventilation slots is blocked, otherwise the unit will be overheated.
- Before operation, ensure that you are connecting this product to the proper voltage in accordance with the specifications in this manual or on the product's specification label.
- It's important to ground the yellow/green conductor to earth in order to avoid electric shock.
- Minimum ambient temperature Ta: -20°C. Maximum ambient temperature Ta: 45°C.
- Do not operate this product at a lower or higher temperature.
- Do not connect the device to any dimmer pack.
- When the lamp is running, do not place combustible objects next to it. The shortest distance between the device and inflammable and explosive objects or materials is 1m.
- Make sure the power cord is not crimped or damaged; replace it immediately if damaged.
- Unit's surface temperature may reach up to 65°C. do not touch the housing bare-handed during its operation.
- Avoid any flammable liquids, water or metal from entering the unit. Once it happens, cut off the mains power immediately.
- Do not operate in a dirty or dusty environment. do clean the fixture regularly.
- Do not touch any wire during operation as there might be a hazard of electric shock.
- Avoid entanglement of the power cord with other wires.
- The minimum distance to objects/surface must be more than 3 meters.
- In the event of serious operating problem, stop using the unit immediately.
- Never turn on and off the unit time after time.
- The housing, the lenses, or the ultraviolet filter must be replaced if they are visibly damaged.

- Do not open the housing as there are no user serviceable parts inside.
- Do not attempt to operate this unit if it becomes damaged. do not attempt any repairs yourself. Repairs carried out by unskilled people can lead to damage or malfunction. Please contact the nearest authorized technical assistance center if needed.
- Disconnect this product from its power source before servicing.
- Do use the original packaging if the device is to be transported.
- Avoid direct eye exposure to the light source while the product is on.
- Do not operate this product if you see damage on the housing, shields, or cables.

Have the damaged parts replaced by an authorized technician at once.

Installation:

The fixture should be fixed on the clamp. always ensure that the unit is firmly fixed to avoid vibration and slipping off during operation. ensure that the trussing or area of installation must be able to hold 10 times the weight without any deformation. Always install a safety cable that can hold at least 12 times the weight of the fixture when installing.do install and operate by qualified operator. It must be installed in a place where there is out of the reach of people.

2. Technical Specifications

OPTICS

- Light source: Color light: 672 × 0.5W RGB LED+White light: 112 × 3W CW LED
- Beam angle: 71.5 °
- Spot angle: 114 °
- Clearly indicate: Ra≥80
- Average lifespan of light source: 20000H

EFFECT

- Mixing System: Uniform RGB Mixing System and Rainbow Effect
- Control: The light source supports color/white light partition control, with outstanding transformation effects
- Effect macros: static effect macros and dynamic effect macros functions
- Dimming: Electronic dimming, providing four dimming curves
- Strobe: 1-30Hz electronic strobe and random strobe

CONTROL AND PROGRAMMING

- Control channels: 15CH (default), 07CH, 70CH, 117CH, 68CH, 65CH, 33CH, 17CH, 112CH, 39CH, 21CH, see channel table for details
- Control protocols: Standard DMX512 protocol, RDM protocol, ART-NET protocol
- Data connection: RJ45 Ethernet port input/output, three core (default) or five core signal input/output
- Display: LCD screen

SOFTWARE

- Upgrade software through DMX signal interface
- Intelligent temperature control ensures LED lifespan

POWER SUPPLY

- Input voltage: AC 100-240V 50/60Hz
- Power: 450W
- Power factor: greater than 0.96
- Maximum current of the lamp: 2.1A/220V; 4.5A/100V

DIMENSION

- Product size: 1000 × 93 × 225mm
- N.W.: 8.8 kg
- Carton packaging (default): 1095 × 310 × 170mm
- G.W.: 11.9 kg
- Flycase Size(10 sets): 1060x700x670mm
- G.W.: 141.9 kg

OTHER

- Protection level: IP66
- Work environment:- 20°C ~ 45°C
- Maximum surface temperature of lamp body: 65 °C

APPROVALS

- The product implementation standard: GB/T 7000.1-2023 、 GB/T 7000.217-2023
- Approved certifications: CE、 RoHs
- The product complies with the following EU directives:
- Low Voltage Directive 2014/35/EU . EMC Directive 2014/30/EU

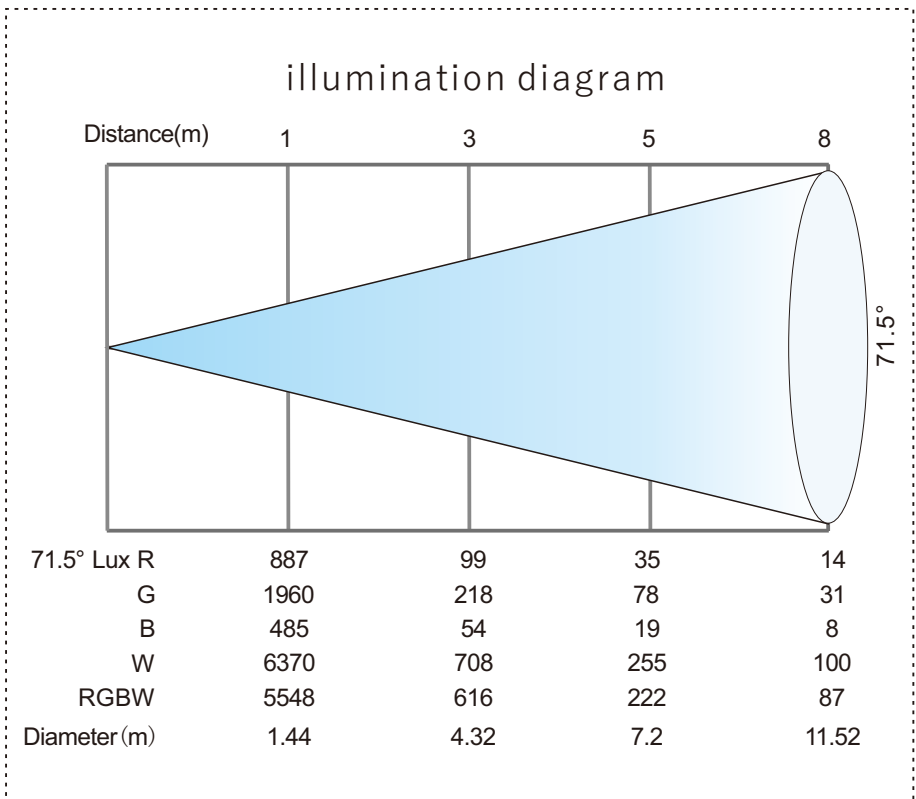

2.1.Attachment And Size

Attachment contents-Fig.1

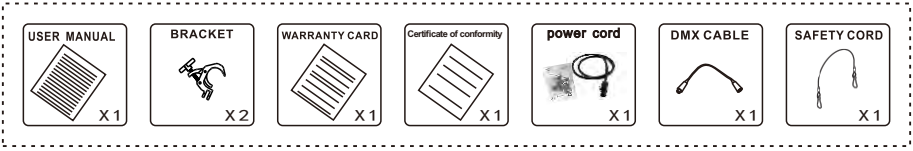

Size-Fig.2(Unit: mm)

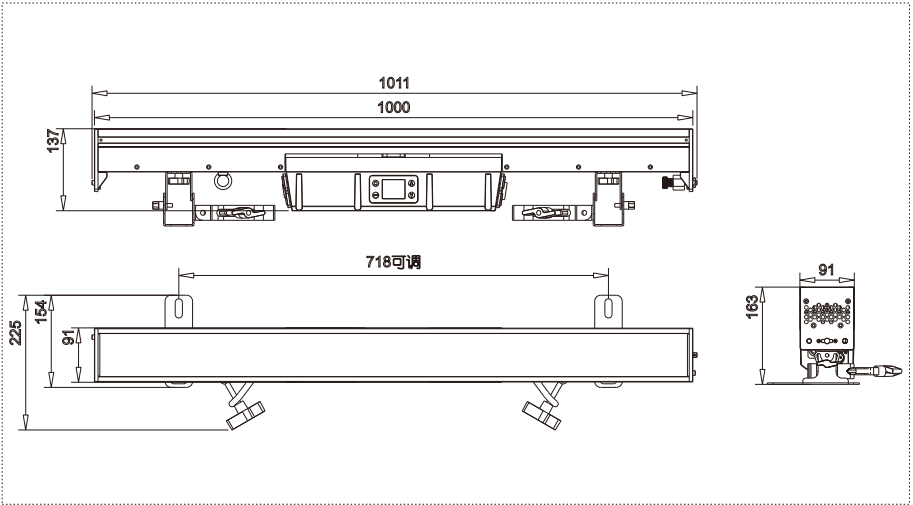

2.2. Lamp Splicing

- 1、 The positioning pin of the lamp is aligned with the positioning hole, and the lamp is attached.

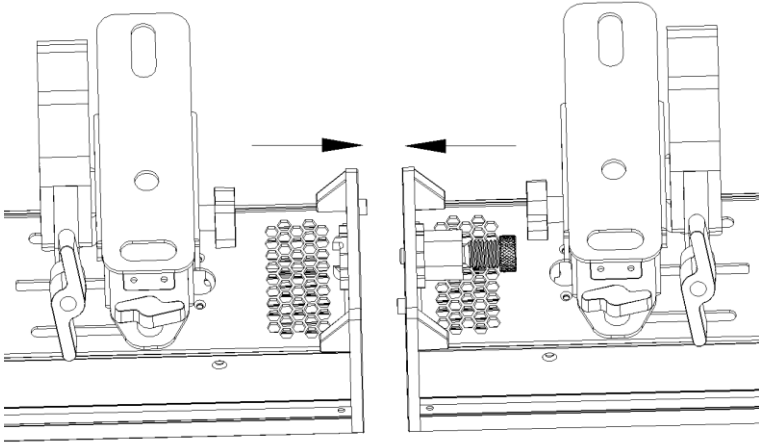

- 1、 Push the lock pin to the square of the arrow and rotate it 90 degrees clockwise; Then turn the hexagon nut clockwise and lock it.

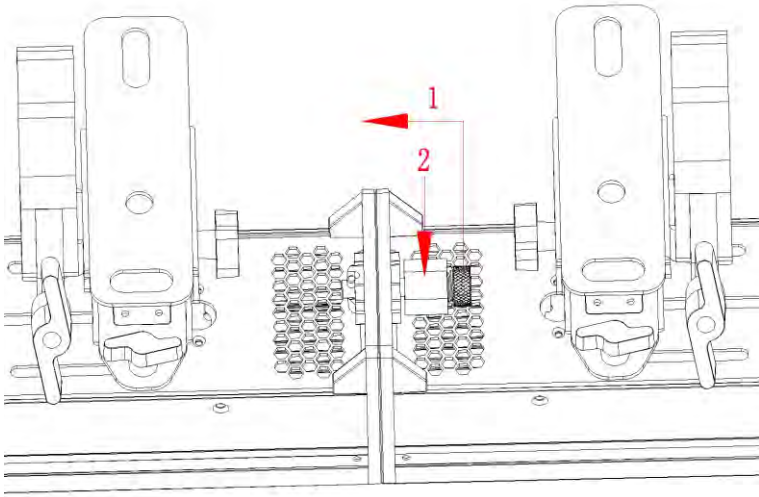

3.Connection and Control

3.1.Power Supply Connection

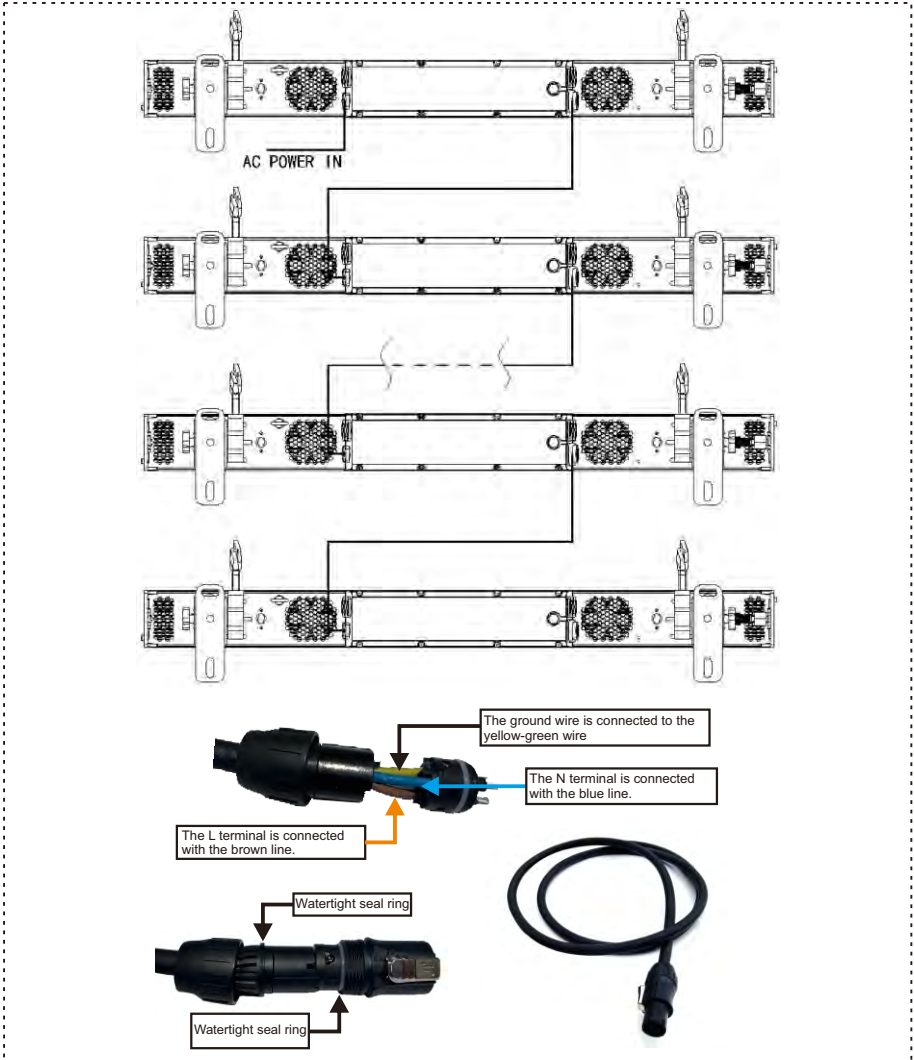

- The bus connecting the power supply must be installed by a qualified professional technician.
- After completing all the above operations and ensuring that it is installed, you can power on the lamp to operate.
- AC100V The power cord can connect up to 4 lamps in series.
- AC220V The power cord can connect up to 8 lamps in series.

3.2.DMX 512 Connection

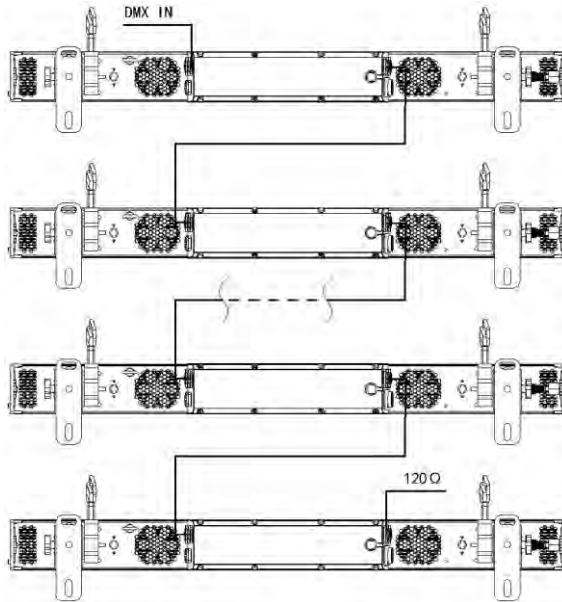

DMX-input

- 1- Shield
- 2- Signal (-)
- 3- Signal (+)
- 4- Not connected
- 5- Not connected



DMX - output

- 1- Shield
- 2- Signal (-)
- 3- Signal (+)
- 4- Not connected
- 5- Not connected

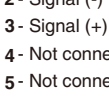

- 1、 At last unit, the DMX cable has to be terminated with a terminator. Solder a 1200hm 1/4W resistor between pin 2(DMX-) and pin 3(DMX+) into a 3-pin XLR-plug and plug it in the DMX-output of the last unit.
 - 2、 Connect the unit together in a "daisy chain" by XLR plug cable from the output of the unit to the input of the next unit. The cable cannot be branched or split to a "Y" cable. DMX 512 is a very high-speed signal. Inadequate or damaged cables, soldered joints or corroded connectors can easily distort the signal and shut down the system.
 - 3、 The DMX output and input connectors are pass-through to maintain the DMX circuit, when one of the units' power is disconnected.
 - 4、 Each lighting unit needs to have a DMX address to receive the data by the controller. The address number is between 1-512.
 - 5、 The end of the DMX 512 system should be terminated to reduce signal errors.
 - 6、 3 pin XLR connectors are more popular than 5 pins XLR.
- 3 pin XLR: Pin 1: GND, Pin 2: Negative signal (-), Pin 3: Positive signal (+)
 5 pin XLR: Pin 1: GND, Pin 2: Negative signal (-), Pin 3: Positive signal (+), Pin4, Pin5 not used.

3.3.Control Panel



The lamp adopts four capacitive touch buttons. In order to prevent misoperation caused by rain, please press the display prompt when setting the lamp and touch the corresponding button to unlock it.

Quick operation

- 1: Press the UP key in the standby interface to view the UID and software version information of lamps and lanterns.
- 2: Press the DOWN key in the standby interface to view the lamp error message.
- 3: Press UP and DOWN keys at the same time in the standby interface to quickly change the display direction of the display screen.
- 4: When setting DMX address, press ENTER to ENTER. When the address code background is red, press UP/DOWN to add and subtract 1, press ENTER to add and subtract the address code background, press UP/DOWN to add and subtract the address code according to the lighting channel, and then press Enter to turn the address code background into white, and the address code value is saved.

Synchronous setting

The lamps and lanterns connected with the same DMX signal line/network cable can be synchronized with other lamps and lanterns when setting some functions.

- 1: One light is set as the host. (Settings--Master/Remote--Master)
- 2: Set the settings that the host needs to change, and press ENTER to save.
- 3: Select this setting, press ENTER for a long time, and a synchronization prompt will pop up. Select Yes, and then press ENTER for synchronization.
- 4: After setting the synchronous light, set this light as a slave. (Settings--Master/Remote--Slave)

4.How To Set The Unit

4.1.Main Function

DMX Addr:001		
Signal Src	DMX512	
	ArtNet	
Art-Net IP Settings	DHCP	N
		Y
	IP	002.000.000.000
	Mask	255.000.000.000
	GW	255.000.000.000
	Net	000 (0-127)
	Sub Net	00 (0-15)
	Universe	00 (0-15)
Channel Mode	15CH	
	70CH	
	117CH	
	68CH	
	65CH	
	33CH	
	17CH	
	112CH	
	39CH	
	21CH	
	7CH	
RunMode	DMX	
	Auto	
Settings	Master/Remote	Slave
		Master
	DimCurve	Linear
		SquareRoot
		S-Curve
		Square
DimSpeed	Fast	

Synchronizable setting

Synchronizable setting

This setting is restarted without saving.

This setting is restarted without saving.

Synchronizable setting

		Slow	
	Pixelv Inversion	No	
		Yes	
	Lost Signal	Keep	
		Shutter Off	
DMX Manual	Auto Exit	Never	Synchronizable setting
		300Sec	
		180Sec	
		120Sec	
		90Sec	
		60Sec	
		40Sec	
		30Sec	
		20Sec	
		10Sec	
	Keep	No	Synchronizable setting
		Yes	
	Red	000-255	
	Green	000-255	
	Blue	000-255	
	White	000-255	
	Dim	000-255	
	StrobeKeepTime	000-255	
	StrobeSpeed	000-255	
	Frost	000-255	
Adv. Settings	Display Settings	Sleep	Never
			300Sec
			180Sec
			Synchronizable setting

			120Sec		
			90Sec		
			60Sec		
			40Sec		
			30Sec		
			20Sec		
			10Sec		
		Invert	N		Synchronizable setting
			Y		
		Display Lock	Off		Synchronizable setting
On					
Language	中文	Synchronizable setting			
	Eng				
Restore Settings	No/Yes				
Factory Settings					
Info	DMX Monitor	DmxValue001-032			
		DmxValue033-064			
		DmxValue065-096			
		DmxValue097-117			
		FPS			
		Total Chns			
	LED UsageTime	Current			
		Total			
		Clear			
	Test				
	Error.				
	Product Code				

5.Channel Setting

Enter the MENU menu, select DMX settings, choose channel mode, press the ENTER button to confirm, you can use the up and down keys to select: 15 channels (default), 7 channels, 70 channels, 117 channels, 68 channels, 65 channels, 33 channels, 17 channels, 112 channels, 39 channels, 21 channels, press ENTER to confirm the selection, press MENU to return to the previous menu.

5.1.Address Setting

Enter the MENU, select the DMX settings function, choose the DMX address, press the ENTER button to confirm, and the current DMX address will be displayed on the screen. Use the up/down buttons to select addresses 001~512, and press the ENTER button to save. Press the ENTER button to return to the previous menu.

Please refer to the following diagram to address your DMX512 channel for the first 4 units.

Channel mode	Unit 1 Address	Unit 2 Address	Unit 3 Address	Unit 4 Address
15 Channel	1	16	31	46
07 Channel	1	08	15	22
70 Channel	1	71	141	211
117 Channel	1	118	235	352
68 Channel	1	69	137	205
65 Channel	1	66	131	196
33 Channel	1	34	67	100
17 Channel	1	18	35	52
112 Channel	1	113	225	337
39 Channel	1	40	79	118
21 Channel	1	22	43	64

5.2. Block Distribution

17 Channel I RGB

1	2	3	4
---	---	---	---

17 Channel I W

1	2	3	4
---	---	---	---

33 Channel I RGB

1	2	3	4	5	6	7	8
---	---	---	---	---	---	---	---

33 Channel I W

1	2	3	4	5	6	7	8
---	---	---	---	---	---	---	---

39 Channel I RGB

1	2	3	4
5	6	7	8

39 Channel I W

1	2	3	4
---	---	---	---

65/68/70 Channel I RGB

1	2	3	4	5	6	7	8	9	10	11	12	13	14	15	16
---	---	---	---	---	---	---	---	---	----	----	----	----	----	----	----

65/68/70 Channel I W

1	2	3	4	5	6	7	8	9	10	11	12	13	14	15	16
---	---	---	---	---	---	---	---	---	----	----	----	----	----	----	----

112/117 Channel I RGB

1	2	3	4	5	6	7	8	9	10	11	12	13	14	15	16
17	18	19	20	21	22	23	24	25	26	27	28	29	30	31	32

112/117 Channel I W

1	2	3	4	5	6	7	8	9	10	11	12	13	14	15	16
---	---	---	---	---	---	---	---	---	----	----	----	----	----	----	----

5.3.DMX 512 Configuration

Please control the fixture by referring to the configurations below

7 CHANNELS		
CHANNEL	DMX VALUE	FUNCTION
1	000-255	Red
2	000-255	Green
3	000-255	Blue
4	000-255	White
5		Dimmer
	000-005	No Function
	006-255	Dimmer 0-100%
6	000-255	Dimmer Fine
7	000-255	Frost

15 CHANNELS		
CHANNEL	DMX VALUE	FUNCTION
1	000-255	Red
2	000-255	Green
3	000-255	Blue
4	000-255	White
5		Color Macro
	000-009	No Function
	010-017	Color1
	018-024	Color2
	025-032	Color3
	033-039	Color4
	040-047	Color5
	048-054	Color6
	055-061	Color7
	062-069	Color8
	070-076	Color9
	077-084	Color10
	085-091	Color11
	092-099	Color12
	100-106	Color13
	107-113	Color14
	114-121	Color15
	122-128	Color16
129-136	Color17	
137-143	Color18	
144-151	Color19	

	152-158	Color20
	159-165	Color21
	166-173	Color22
	174-180	Color23
	181-188	Color24
	189-195	Color25
	196-203	Color26
	204-210	Color27
	211-217	Color28
	218-225	Color29
	226-232	Color30
	233-240	Color31
	241-247	Color32
	248-255	Color33
6		Dimmer
	000-005	No Function
	006-255	Dimmer 0--100%
7	000-255	Dimmer Fine
8	000-255	Strobe Duration
9		Strobe Rate
	000-006	No Function
	007-255	Slow--Fast
10		Strobe
	000-005	No Function
	006-050	Ramp up
	051-100	Ramp down
	101-150	Ramp up-down
	151-200	Lightning
201-255	Random	
11		Macro RGB
	000-023	No Macro
	024-031	Macro1
	032-039	Macro2
	040-047	Macro3
	048-055	Macro4
	056-063	Macro5
	064-071	Macro6
	072-079	Macro7
	080-087	Macro8
	088-095	Macro9
	096-103	Macro10
104-111	Macro11	
112-119	Macro12	

	120-127	Macro13
	128-135	Macro14
	136-143	Macro15
	144-151	Macro16
	152-159	Macro17
	160-167	Macro18
	168-175	Macro19
	176-183	Macro20
	184-191	Macro21
	192-199	Macro22
	200-207	Macro23
	208-215	Macro24
	216-223	Macro25
	224-231	Macro26
	232-239	Macro27
	240-247	Macro28
	248-255	Macro29
		Macro White
	000-090	No Macro
	091-105	Macro1
	106-120	Macro2
	121-135	Macro3
	136-150	Macro4
	151-165	Macro5
	166-180	Macro6
	181-195	Macro7
	196-210	Macro8
	211-225	Macro9
	226-240	Macro10
	241-255	Macro11
		Macro Speed
13	000-127	Normal, Slow--Fast
	128-255	Inversion, Slow--Fast
14	000-255	Fade
15	000-255	Frost

21 CHANNELS		
CHANNEL	DMX VALUE	FUNCTION
1	000-255	Red
2	000-255	Green
3	000-255	Blue
4		Color Macro
	000-009	No Function
	010-017	Color1
	018-024	Color2
	025-032	Color3
	033-039	Color4
	040-047	Color5
	048-054	Color6
	055-061	Color7
	062-069	Color8
	070-076	Color9
	077-084	Color10
	085-091	Color11
	092-099	Color12
	100-106	Color13
	107-113	Color14
	114-121	Color15
	122-128	Color16
	129-136	Color17
	137-143	Color18
	144-151	Color19
	152-158	Color20
	159-165	Color21
	166-173	Color22
	174-180	Color23
	181-188	Color24
	189-195	Color25
	196-203	Color26
	204-210	Color27
	211-217	Color28
	218-225	Color29
	226-232	Color30
	233-240	Color31
241-247	Color32	
248-255	Color33	
5		Dimmer RGB
	000-005	No Function

	006-255	Dimmer 0--100%
6	000-255	Dimmer Fine RGB
7	000-255	Strobe Duration RGB
8		Strobe Rate RGB
	000-006	No Function
	007-255	Slow--Fast
9		StrobeRGB
	000-005	No Function
	006-050	Ramp up
	051-100	Ramp down
	101-150	Ramp up-down
	151-200	Lightning
	201-255	Random
10		Macro RGB
	000-023	No Macro
	024-031	Macro1
	032-039	Macro2
	040-047	Macro3
	048-055	Macro4
	056-063	Macro5
	064-071	Macro6
	072-079	Macro7
	080-087	Macro8
	088-095	Macro9
	096-103	Macro10
	104-111	Macro11
	112-119	Macro12
	120-127	Macro13
	128-135	Macro14
	136-143	Macro15
	144-151	Macro16
	152-159	Macro17
	160-167	Macro18
	168-175	Macro19
	176-183	Macro20
	184-191	Macro21
	192-199	Macro22
	200-207	Macro23
	208-215	Macro24
	216-223	Macro25
	224-231	Macro26
232-239	Macro27	
240-247	Macro28	

	248-255	Macro29
11		Macro Speed RGB
	000-127	Normal, Slow--Fast
	128-255	Inversion, Slow--Fast
12	000-255	Fade RGB
13		Dimmer White
	000-005	No Function
	006-255	Dimmer 0--100%
14	000-255	Dimmer Fine White
15	000-255	Strobe Duration White
16		Strobe Rate White
	000-006	No Function
	007-255	Slow--Fast
17		StrobeW
	000-005	No Function
	006-050	Ramp up
	051-100	Ramp down
	101-150	Ramp up-down
	151-200	Lightning
	201-255	Random
18		Macro White
	000-090	No Macro
	091-105	Macro1
	106-120	Macro2
	121-135	Macro3
	136-150	Macro4
	151-165	Macro5
	166-180	Macro6
	181-195	Macro7
	196-210	Macro8
	211-225	Macro9
	226-240	Macro10
241-255	Macro11	
19		Macro Speed White
	000-127	Normal, Slow--Fast
	128-255	Inversion, Slow--Fast
20	000-255	Fade White
21	000-255	Frost

17 CHANNELS		
CHANNEL	DMX VALUE	FUNCTION
1	000-255	Red1
2	000-255	Green1
3	000-255	Blue1
4	000-255	Red2
5	000-255	Green2
6	000-255	Blue2
7	000-255	Red3
8	000-255	Green3
9	000-255	Blue3
10	000-255	Red4
11	000-255	Green4
12	000-255	Blue4
13	000-255	White1
14	000-255	White2
15	000-255	White3
16	000-255	White4
17	000-255	Frost

33 CHANNELS		
CHANNEL	DMX VALUE	FUNCTION
1	000-255	Red1
2	000-255	Green1
3	000-255	Blue1
4	000-255	Red2
5	000-255	Green2
6	000-255	Blue2
.....	000-255
19	000-255	Red7
20	000-255	Green7
21	000-255	Blue7
22	000-255	Red8
23	000-255	Green8
24	000-255	Blue8
25	000-255	White1
26	000-255	White2
.....	000-255
31	000-255	White7
32	000-255	White8
33	000-255	Frost

39 CHANNELS		
CHANNEL	DMX VALUE	FUNCTION
1	000-255	Red1
2	000-255	Green1
3	000-255	Blue1
4	000-255	Red2
5	000-255	Green2
6	000-255	Blue2
7	000-255	Red3
.....	000-255
19	000-255	Red7
20	000-255	Green7
21	000-255	Blue7
22	000-255	Red8
23	000-255	Green8
24	000-255	Blue8
25		Dimmer RGB
	000-005	No Function
	006-255	Dimmer 0--100%
26	000-255	Dimmer Fine RGB
27	000-255	Strobe Duration RGB
28		Strobe Rate RGB
	000-006	No Function
	007-255	Slow--Fast
29		StrobeRGB
	000-005	No Function
	006-050	Ramp up
	051-100	Ramp down
	101-150	Ramp up-down
	151-200	Lightning
201-255	Random	
30	000-255	White1
31	000-255	White2
32	000-255	White3
33	000-255	White4
34		Dimmer White
	000-005	No Function
	006-255	Dimmer 0--100%
35	000-255	Dimmer Fine White
36	000-255	Strobe Duration White
37		Strobe Rate White

	000-006	No Function
	007-255	Slow--Fast
38		StrobeW
	000-005	No Function
	006-050	Ramp up
	051-100	Ramp down
	101-150	Ramp up-down
	151-200	Lightning
	201-255	Random
39	000-255	Frost

65 CHANNELS		
CHANNEL	DMX VALUE	FUNCTION
1	000-255	Red1
2	000-255	Green1
3	000-255	Blue1
4	000-255	Red2
5	000-255	Green2
6	000-255	Blue2
.....	000-255
43	000-255	Red15
44	000-255	Green15
45	000-255	Blue15
46	000-255	Red16
47	000-255	Green16
48	000-255	Blue16
49	000-255	White1
50	000-255	White2
.....	000-255
63	000-255	White15
64	000-255	White16
65	000-255	Frost

68 CHANNELS		
CHANNEL	DMX VALUE	FUNCTION
1		Dimmer
	000-005	No Function
	006-255	Dimmer 0--100%
2		Strobe RGB
	000-007	No Function
	008-127	Strobe Slow--Fast
	128-130	No Function
	131-250	Random
	251-255	No Function
3		Strobe White
	000-007	No Function
	008-127	StrobeSlow--Fast
	128-130	No Function
	131-250	Random
	251-255	No Function
4	000-255	Frost
5	000-255	Red1
6	000-255	Green1
7	000-255	Blue1
8	000-255	Red2
9	000-255	Green2
10	000-255	Blue2
.....	000-255
47	000-255	Red15
48	000-255	Green15
49	000-255	Blue15
50	000-255	Red16
51	000-255	Green16
52	000-255	Blue16
53	000-255	White1
54	000-255	White2
.....	000-255
67	000-255	White15
68	000-255	White16

70 CHANNELS		
CHANNEL	DMX VALUE	FUNCTION
1		Dimmer
	000-005	No Function
	006-255	Dimmer 0--100%
2		Strobe RGB
	000-007	No Function
	008-127	Strobe Slow--Fast
	128-130	No Function
	131-250	Random
	251-255	No Function
3		Strobe White
	000-007	No Function
	008-127	Strobe Slow--Fast
	128-130	No Function
	131-250	Random
	251-255	No Function
4	000-255	Frost
5	000-255	Red1
6	000-255	Green1
7	000-255	Blue1
8	000-255	Red2
9	000-255	Green2
10	000-255	Blue2
.....	000-255
47	000-255	Red15
48	000-255	Green15
49	000-255	Blue15
50	000-255	Red16
51	000-255	Green16
52	000-255	Blue16
53	000-255	White1
54	000-255	White2
	000-255	
67	000-255	White15
68	000-255	White16
69	000-255	Fade RGB
70	000-255	Fade White

112 CHANNELS		
CHANNEL	DMX VALUE	FUNCTION
1	000-255	Red1
2	000-255	Green1
3	000-255	Blue1
4	000-255	Red2
5	000-255	Green2
6	000-255	Blue2
.....	000-255
91	000-255	Red31
92	000-255	Green31
93	000-255	Blue31
94	000-255	Red32
95	000-255	Green32
96	000-255	Blue32
97	000-255	White1
98	000-255	White2
.....	000-255
111	000-255	White15
112	000-255	White16

117 CHANNELS		
CHANNEL	DMX VALUE	FUNCTION
1		Dimmer
	000-005	No Function
	006-255	Dimmer 0--100%
2	000-255	Strobe Duration
3		Strobe Rate
	000-006	No Function
	007-255	Slow--Fast
4		Strobe
	000-005	No Function
	006-050	Ramp up
	051-100	Ramp down
	101-150	Ramp up-down
	151-200	Lightning
	201-255	Random
5	000-255	Frost
6	000-255	Red1
7	000-255	Green1
8	000-255	Blue1
9	000-255	Red2
10	000-255	Green2
11	000-255	Blue2
.....	000-255
96	000-255	Red31
97	000-255	Green31
98	000-255	Blue31
99	000-255	Red32
100	000-255	Green32
101	000-255	Blue32
102	000-255	White1
103	000-255	White2
.....	000-255
116	000-255	White15
117	000-255	White16

6. Electrical Connection Diagram

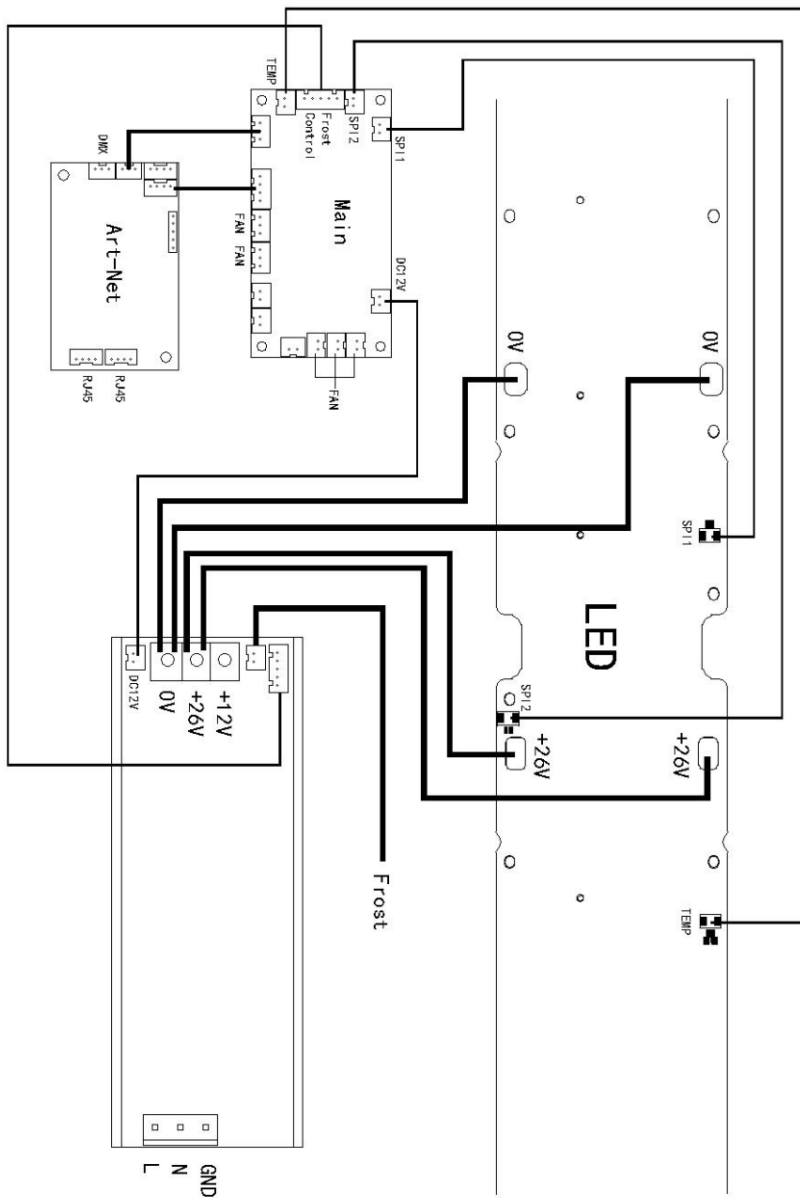

7. Troubleshooting

The following are common faults of lighting fixtures and corresponding solutions. Malfunctions that cannot be repaired by oneself should be handled by personnel with professional qualifications. Before maintaining the lamp, please disconnect the power supply first.

■ LED off:

- Please check if install the suitable voltage
- Please check whether the led will reach the end of their life can explode; please replace a same description led.
- Please check if the power supply is enough.
- Please check whether the DMX 512 controller pass the "turn on" order.

■ The light couldn't accept the control order:

- Please check the start code address and the function option are correct.
- Please check whether the communicate control cable is on good connection or the cable is too long or interrupt.
- Please check the control system is not valid, check the signal amplifier of chain connected is valid.
- Please check whether the communicate cable is too long or the other equipment is mutually conjugate.
- Please arrange the wire well, shorter the signal cable, put the high voltage cable and low voltage cable separately.
- Add the signal amplify isolator.
- Signal cable is used the excellent screening doublet
- The end of the light end and the end resistance.

■ The light can't move:

- Please check if the power supply is suitable for the light voltage data.
- Please check the light if they are deformation, inside parts is broken, become wet etc will lead the loose contact.
- Please check the if the inside lead wire and the connector is loose.
- Please check the electric parts(such as the transformer,PCB board,contrller) is short-circuit or burn down.

8. Fixture Cleaning

It is absolutely essential that the fixture is kept clean to ensure the maximum light-output and allow the fixture to function reliably throughout its life. The fixture must be cleaned regularly to avoid dust, dirt and smoke-fluid residues building up on or within the fixture. The cleaning frequency depends on the application environment. Clean the fixture immediately if the dust enters it to avoid damage to the optical lens due to excessive dust.

- * Before maintenance and disassembly of lighting fixtures, the power supply must be disconnected and live operation is not allowed.
- * A soft lint-free cloth moistened with any good glass cleaning fluid is recommended, under no circumstances should solvents be used.
- * Always dry the parts carefully.
- * You need to wipe the outside of the lens at least once every 20 days.
- * After the colored paper performance of the lighting fixtures, it is necessary to check whether there are any paper scraps stuck or sucked in at the air inlet and outlet, and clean them thoroughly, otherwise it may damage the fan or cause a fire hazard.

CAUTION ! ! !

Disconnect from mains before starting maintenance operation.

9. Duty Exonerative and Copyright protectio

- * Light source belongs to consumption products, not within the scope of warranty.
- * The manufacturer shall not bear any responsibility for any damage caused by failure to operate in accordance with this instruction.
- * All the information in this manual shall be interpreted by the manufacturer.
- * All the information in this manual shall not be copied without permission.
- * The data contained in this statement are subject to change in the future without prior notice.