

0-10V Athena LED Driver 96 watt - Installation Instructions

Models PS-010V-LIN-D-96-24-AWNR, PS-010V-LOG-D-96-24-AWNR

Please read all instructions prior to installation and keep for future reference!

This LED Driver is to be installed in accordance with Article 450 of the National Electrical Code. The LED Driver must be installed in a well ventilated area and free from explosive gases and vapors. Proper operation requires the free flow of air as this LED Driver is hardwired, it should only be installed by a qualified electrician. Suitable For Dry Location.

PLENUM FOR SUCH USE IN ACCORDANCE WITH UL2043



REVO.2
12202023

1 / 3



7777 Merrimac Ave
Niles, IL 60714
T 224.333.6033
F 224.757.7557
info@luminii.com
www.luminii.com

Input	120 - 277 V AC, 1.1 A, 50/60 Hz
Output	24 V DC, 4.0 A
Max. Wattage	96 W

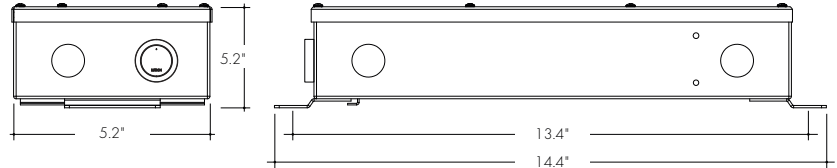

1

Before installing, check the label and ensure the LED Driver has the proper input voltage, output voltage, and wattage for the job. Check the wire markings to ensure they match the wiring diagram below. Refer to table above for the maximum loads!

3.0" min

1.1 LED Driver can be mounted vertically or horizontally. With a minimum of 3" clearance around LED Driver to provide proper air circulation.

1.2 Ensure that the Lutron Athena Wireless node has at least 1" clearance from any metal such as conduit.

2

cover

housing

2.1 Remove the cover from top of the driver housing to expose the driver wires. Screws for cover will be found inside the housing.

3

Input
120-277V AC

L
N
GRD

3.1 Connect the 120-277V AC power into the housing from the electrical panel, followed by connecting the 24V DC low voltage conduit for the LED. There is no control wire connections to make since the power supply is already connected to the Athena wireless node.

0 -10V Athena LED Driver 96 watt - Installation Instructions

Models PS-010V-LIN-D-96-24-AWNR, PS-010V-LOG-D-96-24-AWNR

Please read all instructions prior to installation and keep for future reference!

This LED Driver is to be installed in accordance with Article 450 of the National Electrical Code. The LED Driver must be installed in a well ventilated area and free from explosive gases and vapors. Proper operation requires the free flow of air as this LED Driver is hardwired, it should only be installed by a qualified electrician. Suitable For Dry Location.

PLENUM FOR
SUCH USE IN
ACCORDANCE
WITH UL2043



REVO.2
12202023

2 / 3



7777 Merrimac Ave
Niles, IL 60714
T 224.333.6033
F 224.757.7557
info@luminii.com
www.luminii.com

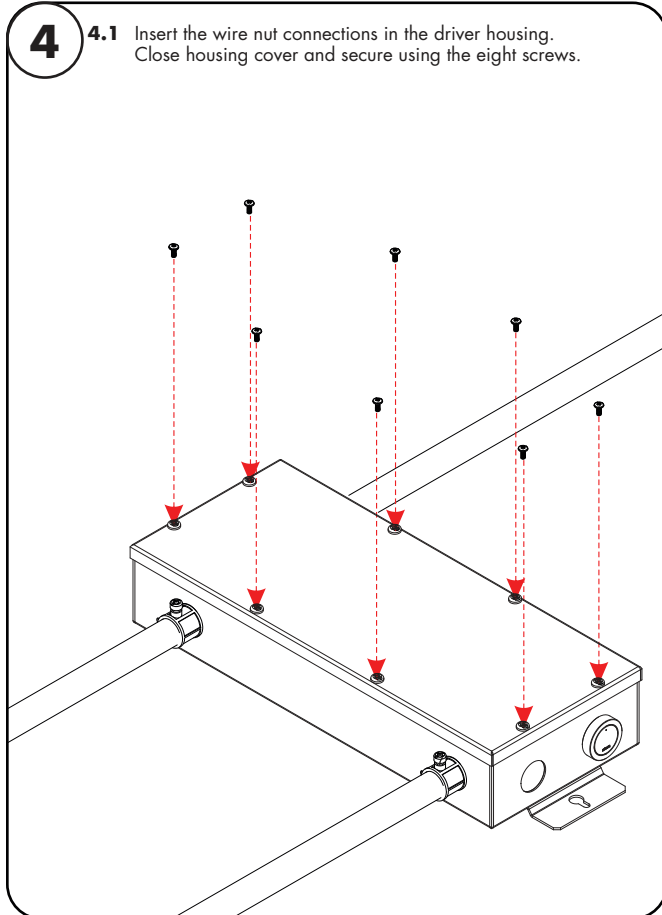

0 -10V Athena LED Driver 96 watt - Installation Instructions

Models PS-010V-LIN-D-96-24-AWNR, PS-010V-LOG-D-96-24-AWNR

Please read all instructions prior to installation and keep for future reference!

This LED Driver is to be installed in accordance with Article 450 of the National Electrical Code. The LED Driver must be installed in a well ventilated area and free from explosive gases and vapors. Proper operation requires the free flow of air as this LED Driver is hardwired, it should only be installed by a qualified electrician. Suitable For Dry Location.

PLENUM FOR SUCH USE IN ACCORDANCE WITH UL2043



REVO.2
12202023

3 / 3



7777 Merrimac Ave
Niles, IL 60714
T 224.333.6033
F 224.757.7557
info@luminii.com
www.luminii.com

Factory Resetting the Lutron Athena Wireless Node using the Lutron App

1

Factory Resetting Lutron Node:

If a node isn't working or you aren't able to add it to a new project, this is a troubleshooting guide to factory reset the Athena wireless node

Step 1: Open the Lutron App

Step 2: Make Sure your device is connected to the same WiFi as the Lutron Athena nodes

Step 3: Select Professional

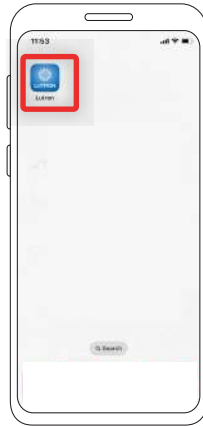

1



2



3

Step 4: Sign into your myLutron Account

Step 5: Click 'Next' to pass through Account screen

Step 6: Select 'Access an Existing System'

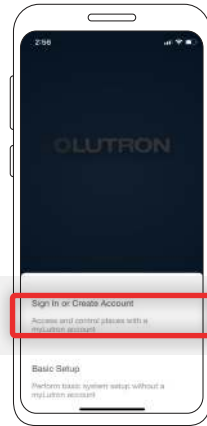

4

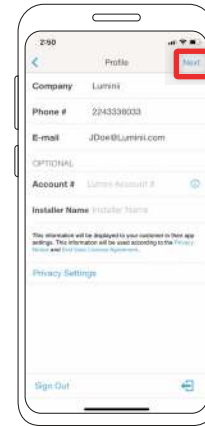

5

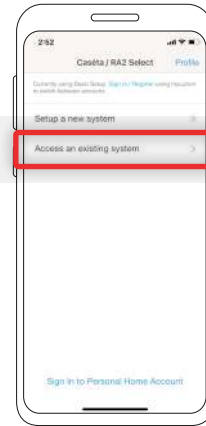

6

Step 7: Select 'More options'

Step 8: Click 'Reset Device'

Step 9: Select 'Continue using app'



7

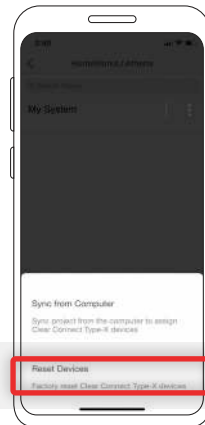

8

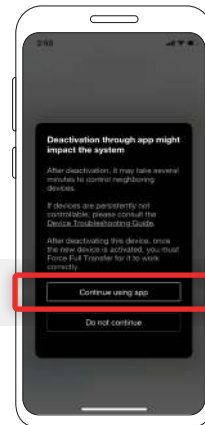

9

Step 10: Follow the next directions on the app to successfully reset the Athena Wireless node

To confirm the Athena node has been reset, power cycle the load connected to that Athena wireless node. The load will either dim to off or cycle through CCT's and then turn to full brightness