

MAGNOMATIC

SIDEWINDER



User Manual

US SKU#:
UPC#:

RSS160
810008261538



©2021 **MAGMATIC EFFECTS** all rights reserved. Information, specifications, diagrams, images, and instructions herein are subject to change without notice. **MAGMATIC EFFECTS** logo and identifying product names and numbers herein are trademarks of **MAGMATIC EFFECTS**. Copyright protection claimed includes all forms and matters of copyrightable materials and information now allowed by statutory or judicial law or hereinafter granted. Product names used in this document may be trademarks or registered trademarks of their respective companies and are hereby acknowledged. All non-MAGMATIC brands and product names are trademarks or registered trademarks of their respective companies.

MAGMATIC EFFECTS and all affiliated companies hereby disclaim any and all liabilities for property, equipment, building, and electrical damages, injuries to any persons, and direct or indirect economic loss associated with the use or reliance of any information contained within this document, and/or as a result of the improper, unsafe, insufficient and negligent assembly, installation, rigging, and operation of this product.

MAGMATIC EFFECTS | 6122 S. Eastern Ave. | Los Angeles, CA. 90040
 323-582-3322 | 323-832-9142 fax | www.elationlighting.com | sales@magmaticeffects.com

Elation Professional B.V. | Junostraat 2 | 6468 EW Kerkrade, The Netherlands
 +31 45 546 85 66 | +31 45 546 85 96 fax | www.elationlighting.eu | info@elationlighting.eu

Elation Professional Mexico | AC Santa Ana 30 | Parque Industrial Lerma, Lerma, Mexico 52000
 +52 (728) 282-7070



DOCUMENT VERSION

Due to additional product features and/or enhancements, an updated version of this document may be available online.

Please check www.elationlighting.com for the latest revision/update of this manual before beginning installation and/or programming.

Date	Document Version	Software Version	DMX Channel Mode	Notes
10/15/20	1.0	1.0	1 / 4 / 7 Channels	Initial Release
12/11/20	2.0	N/C	N/C	Updated Dimensional Drawings & Specifications
07/12/21	3.0	N/C	N/C	Updated Operation & Specifications
12/13/21	4.0	N/C	N/C	Updated Safety Guidelines, System Menu, & Specifications; added FCC Statement, MagFly, and MagRF sections.

CONTENTS

General Information	4
Limited Warranty (USA Only)	5
Warranty Returns (USA Only)	6
Safety Guidelines	7
Overview	9
Operation	10
Control Panel	11
System Menu	12
DMX Channel Functions & Values	16
Macro Table	17
Dimensional Drawings	18
Trouble Shooting Cleaning & Maintenance	19
Specifications	20
MagFly Module	21
MagRF Module	23
FCC Statement	25

GENERAL INFORMATION

INTRODUCTION

Please read and understand the instructions in this manual carefully and thoroughly before attempting to operate this device. These instructions contain important safety and use information.

This product is intended to be used by professionally trained personnel only and is not suitable for private use.

UNPACKING

Every device has been thoroughly tested and has been shipped in perfect operating condition. Carefully check the shipping carton for damage that may have occurred during shipping. If the carton is damaged, carefully inspect the device for damage, and be sure all accessories necessary to install and operate the device have arrived intact. In the event that damage has been found or parts are missing, please contact our customer support team for further instructions. Please do not return this device to your dealer without first contacting customer support. Please do not discard the shipping carton in the trash. Please recycle whenever possible.

BOX CONTENTS

Twist-locking power cable (x1)

CUSTOMER SUPPORT

Contact **MAGMATIC** customer service for any product related service and support needs. Also visit forums.elationlighting.com with questions, comments, or suggestions.

ELATION SERVICE USA - Monday - Friday 8:00am to 4:30pm PST
323-582-3322 | Fax 323-832-9142 | sales@magmaticeffects.com

ELATION SERVICE EUROPE - Monday - Friday 08:30 to 17:00 CET
Voice: +31 45 546 85 63 | Fax: +31 45 546 85 96 | support@elationlighting.eu

REPLACEMENT PARTS: Please visit parts.elationlighting.com



IMPORTANT NOTICE!

THERE ARE NO USER SERVICEABLE PARTS INSIDE THIS UNIT. DO NOT ATTEMPT ANY REPAIRS YOURSELF. DOING SO WILL VOID YOUR MANUFACTURER'S WARRANTY. DAMAGES RESULTING FROM MODIFICATIONS TO THIS FIXTURE AND/OR THE DISREGARD OF SAFETY INSTRUCTIONS AND GUIDELINES IN THIS MANUAL VOID THE MANUFACTURER'S WARRANTY AND ARE NOT SUBJECT TO ANY WARRANTY CLAIMS AND/OR REPAIRS.

NEVER POINT OR AIM A FOG MACHINE TOWARDS PEOPLE OR THEIR CLOTHING. THIS UNIT EMITS HOT VAPOR AND SHOULD BE USED WITH THE SAME CARE THAT YOU WOULD OBSERVE WHEN USING AN ELECTRIC KETTLE OR IRON.

LIMITED WARRANTY (USA ONLY)

A. Magmatic Effects hereby warrants, to the original purchaser, Magmatic products to be free of manufacturing defects in material and workmanship for a period of two years (730 days) from the original date of purchase. This warranty excludes discharge lamps and all product accessories. This warranty shall be valid only if the product is purchased within the United States of America, including possessions and territories. It is the owner's responsibility to establish the date and place of purchase by acceptable evidence, at the time service is sought.

B. For warranty service, send the product only to the Magmatic Effects factory. All shipping charges must be pre-paid. If the requested repairs or service (including parts replacement) are within the terms of this warranty, Magmatic Effects will pay return shipping charges only to a designated point within the United States. If any product is sent, it must be shipped in its original package and packaging material. No accessories should be shipped with the product. If any accessories are shipped with the product, Magmatic Effects shall have no liability what so ever for loss and/or or damage to any such accessories, nor for the safe return thereof.

C. This warranty is void if the product serial number and/or labels are altered or removed; if the product is modified in any manner which Magmatic Effects concludes, after inspection, affects the reliability of the product; if the product has been repaired or serviced by anyone other than the Magmatic Effects factory unless prior written authorization was issued to purchaser by Magmatic Effects; if the product is damaged because not properly maintained as set forth in the product instructions, guidelines and/or user manual.

D. This is not a service contract, and this warranty does not include any maintenance, cleaning or periodic check-up. During the periods as specified above, Magmatic Effects will replace defective parts at its expense, and will absorb all expenses for warranty service and repair labor by reason of defects in material or workmanship. The sole responsibility of Magmatic Effects under this warranty shall be limited to the repair of the product, or replacement thereof, including parts, at the sole discretion of Magmatic Effects. All products covered by this warranty were manufactured after January 1, 1990, and bear identifying marks to that effect.

E. Magmatic Effects reserves the right to make changes in design and/or performance improvements upon its products without any obligation to include these changes in any products theretofore manufactured.

F. No warranty, whether expressed or implied, is given or made with respect to any accessory supplied with the products described above. Except to the extent prohibited by applicable law, all implied warranties made by Magmatic Effects in connection with this product, including warranties of merchantability or fitness, are limited in duration to the warranty periods set forth above. And no warranties, whether expressed or implied, including warranties of merchantability or fitness, shall apply to this product after said periods have expired. The consumer's and/or dealer's sole remedy shall be such repair or replacement as is expressly provided above; and under no circumstances shall Magmatic Effects be liable for any loss and/or damage, direct and/or consequential, arising out of the use of, and/or the inability to use, this product.

G. This warranty is the only written warranty applicable to Magmatic Effects products and supersedes all prior warranties and written descriptions of warranty terms and conditions heretofore published.

WARRANTY RETURNS (USA ONLY)

To obtain warranty service, a Return Material Authorization (RMA) number must first be obtained from MAGMATIC. It is the Customer's responsibility to provide product proof of purchase and serial number by acceptable evidence such as an invoice copy or an approved MAGMATIC Extended Warranty Certificate ("EWC") and any relevant maintenance records at the time warranty service is sought. Failure to provide acceptable evidence of product proof of purchase or EWC and any relevant maintenance records may be cause for denial of warranty service.

Products returned for warranty service must be sent without any accessories (i.e., power, data, and safety cables, brackets, clamps, rigging hardware, frost filters, gel frames, barn doors, lenses, hoses, nozzles, rack mounting hardware, etc.), must be boxed using the original and/or suitable packaging materials (double-box and foam) that provides ample product protection for ground and/or air freight transit, and must be shipped freight pre-paid and insured to MAGMATIC in Los Angeles, CA or a MAGMATIC Authorized Service Center. The RMA number must be clearly written on the outside of the return box, and a brief description of the problem and the RMA number must be documented and included in the box.

Products returned for warranty service without an RMA number clearly marked on the outside of the package will be refused and returned to the shipper at the Customer's expense. Products returned for warranty service, which are received damaged due to inadequate and/or improper packaging and/or due to damage caused by the shipping carrier, may incur additional repair charges before warranty service begins and/or may void this warranty. If any product accessories (included and/or optional) are shipped with the product, MAGMATIC and/or the MAGMATIC Authorized Service Center shall have no liability what so ever for the loss and/or damage to any such accessories, nor the safe return thereof. If the requested warranty repairs or service (including parts replacement) are within the terms of this warranty, MAGMATIC will pay return ground transportation shipping charges to a single designated point within the United States.

SAFETY GUIDELINES

This fixture is a sophisticated piece of electronic equipment. To guarantee smooth operation, it is important to follow all instructions and guidelines in this manual. Magmatic Effects is not responsible for injury and/or damages resulting from the misuse of this fixture due to the disregard of the information printed in this manual. Only qualified and/or certified personnel should perform installation of this fixture and only the original rigging parts included with this fixture should be used for installation. Any modifications to the fixture and/or the included mounting hardware will void the original manufacturer's warranty and increase the risk of damage and/or personal injury.



PROTECTION CLASS 1 - FIXTURE MUST BE PROPERLY GROUNDED.



THERE ARE NO USER SERVICEABLE PARTS INSIDE THIS UNIT. DO NOT ATTEMPT ANY REPAIRS YOURSELF. DOING SO WILL VOID YOUR MANUFACTURER'S WARRANTY. DAMAGES RESULTING FROM MODIFICATIONS TO THIS DEVICE AND/OR THE DISREGARD OF SAFETY INSTRUCTIONS AND GUIDELINES IN THIS MANUAL VOID THE MANUFACTURER'S WARRANTY AND ARE NOT SUBJECT TO ANY WARRANTY



**DO NOT PLUG THIS UNIT INTO A DIMMER PACK
DO NOT REMOVE THE COVER UNDER ANY CONDITIONS
KEEP UNIT IN AN UPRIGHT POSITION
NEVER OPERATE THIS UNIT WITH THE COVER REMOVED
UNPLUG FROM POWER DURING LONG PERIODS OF NON-USE
ENSURE TANK IS EMPTY BEFORE STORAGE OR TRANSPORT
DO NOT MOVE WHEN FILLED WITH FLUID
DISCONNECT POWER BEFORE ADDING FLUID OR PERFORMING MAINTENANCE**



**FOR USE IN INDOOR / DRY LOCATIONS ONLY
DO NOT EXPOSE DEVICE TO RAIN AND/OR MOISTURE
PLACE UNIT IN A WELL VENTILATED AREA
ALLOW 40" (100CM) ABOVE AND AROUND THE UNIT FOR PROPER VENTILATION.**

SAFETY GUIDELINES

IMPORTANT SAFETY INSTRUCTIONS. READ THESE INSTRUCTIONS THOROUGHLY BEFORE USE, AND SAVE THEM FOR FUTURE REFERENCE.

CAUTION:

- Risk of burn, fire, or electric shock.
- For indoor use only.
- Please read the instruction manual carefully before use.
- Do not immerse in liquid.
- Not for space heating use.

WARNING: To prevent risk of personal injury, fire, and electric shock:

- Never leave unit unattended while plugged in. Unplug device when not in use.
- Read all important safety instructions and cautions before attempting to use.
- Connect only to a properly grounded power outlet.
- Place product on a flat, level, HARD surface and connect the cord to prevent the product from tipping or overturning.
- For use in covered areas only! Keep unit dry, and do not expose to rain, moisture, or liquid immersion.
- Leave enough space for adequate ventilation. Keep the device cool and away from other objects.
- Do not operate the device without fog liquid in the reservoir.
- Use caution when filling the fluid reservoir in order to avoid spillage, as spilled liquid can result in electrical shock.
- Do not use if liquid spills into or onto the unit, and allow the device to dry completely before attempting usage.
- Do not overfill the fluid reservoir.
- Keep away from flames and flammable or explosive substances.
- Never pour flammable liquids, such as gas, perfume, etc, into the fog machine.
- Keep the device and fog fluid out of reach of children.
- Use only under adult supervision.
- Do not direct fog output in the direction of people or open flame.
- Stay at least 20 inches (50cm) from the output nozzle on the front of the unit.
- Do not obstruct the output nozzle.
- Do not open the unit for any reason. There are no user serviceable parts inside, and all maintenance and repair procedures should be referred to an authorized vendor or technician.
- Only a certified electrician may replace the power cord.
- Clean the unit prior to storage to avoid damage.

POWER SUPPLY CORD:

- A short power supply cord (or short detachable power-supply cord) is provided to reduce the risk of a person becoming entangled in or tripping over the cord.
- Extension cords (or long detachable power-supply cords) are available and may be used as long as care is exercised during use.
- If an extension cord (or long detachable power-supply cord) is used, follow the guidelines below:
 1. The indicated electrical rating of the cord should be meet or exceed the rating of the device.
 2. If the device is of the grounded type, the cord must use a grounding type 3-wire cord.
 3. The cord should be routed in such a way as not to cause a tripping hazard or result in unintentional snagging or pulling of the cord, especially in the presence of children.

OVERVIEW

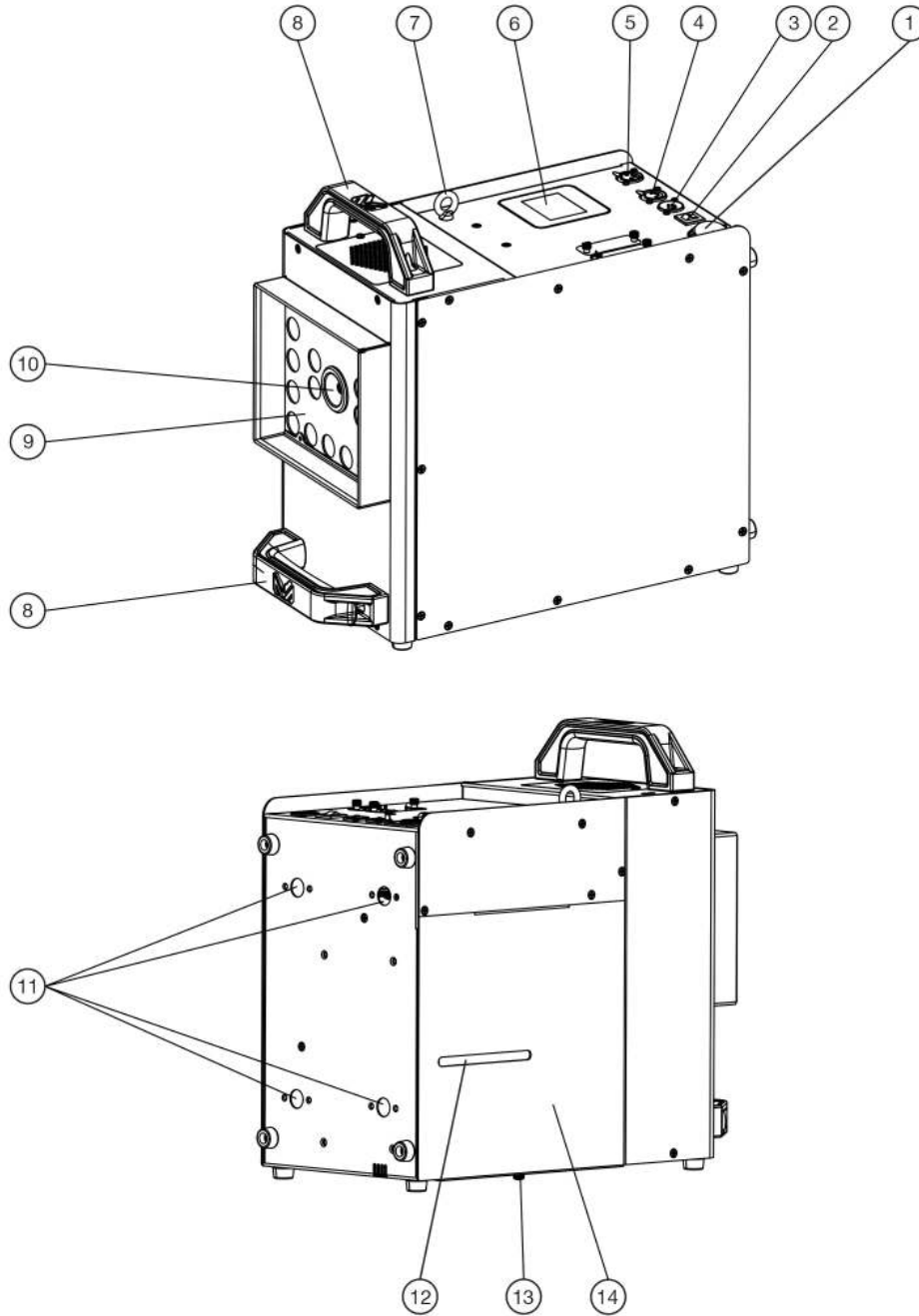

- | | |
|----------------------------|--------------------------------|
| 1. Power In | 8. Carry Handles (x2) |
| 2. Breaker | 9. LED Array |
| 3. DMX In | 10. Fog Outlet |
| 4. DMX Out | 11. Mounting Clamp Points (x4) |
| 5. Wired Remote Port | 12. Tank Level Gauge |
| 6. Touch Display Screen | 13. Latch Screw |
| 7. Safety Cable Attachment | 14. Tank Access Panel |

OPERATION

- When first unboxing, open the shipping carton and carefully remove the device. Be sure to remove ALL the packing material, paying particular attention to the area around the fog outlet vent.
- Always set up the device on a flat dry surface.
- **Make sure that the unit is disconnected from power before adding any fluid to the tank.**
- To access the fluid tank, unscrew the latch screw that is located on the back side of the unit, near the printed notice about the tank fluid, then open the access panel.
- To fill the tank, remove the tank from behind the tank access panel. Unscrew the tank cap and fill with **MAGMATIC ATMOSITY fluid (SKU# AFF only)**, then replace the cap.
- Never run the device on anything other than an approved, MAGMATIC branded fluid, as doing so can result in severe damage to your device.
- When placing the tank back behind the access panel, be careful not to pinch, twist, or tangle the feed tube connected to the tank cap.
- To close and secure the tank access panel, tighten the latch screw by pushing it down while rotating.
- After re-connecting the device to a power source and switching it on, allow the fluid to warm up for at least nine (9) minutes before beginning fog emission.

PLEASE NOTE:

While the fog duration setting can be set as high as 250 seconds, the individual bursts of continuous fog output will only occur for a maximum of 8 seconds. For example, when the user sets a duration of 250 seconds, this does NOT mean that the device will be emitting fog continuously for the entire 250-second period. Rather, the device will produce a series of shorter fog bursts, each lasting up to 8 seconds, throughout the 250-second period.



CONTROL PANEL

This fixture includes a system menu with an easy to navigate touch screen control panel where all necessary settings and adjustments are made. When first powering on the fixture, the fixture's main menu will be displayed (**see Main Menu Screen below**).

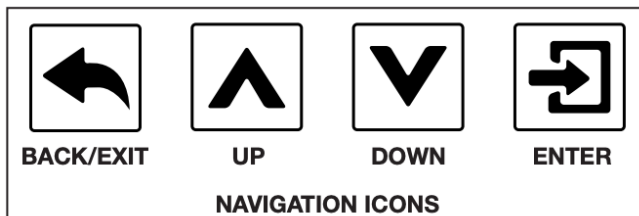
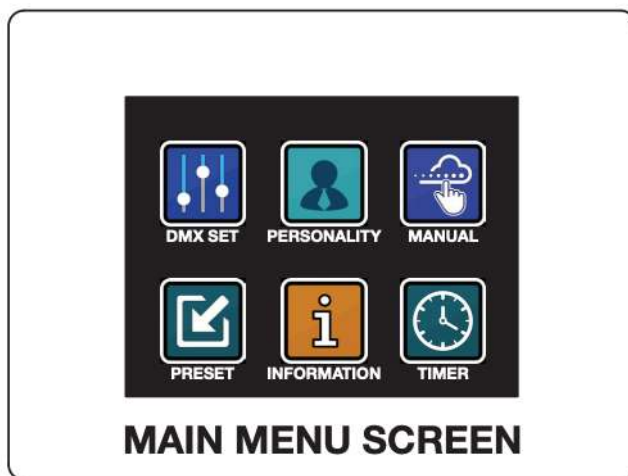
Press the main menu icon you would like to access. Use the **ENTER** button to access sub menus and use the **UP** and **DOWN** buttons to make adjustments. Press the **ENTER** button to confirm your adjustments. You may exit the main menu at any time without making any adjustments by pressing the **BACK/EXIT** button.











SYSTEM MENU



	DMX SET	DMX ADDR	1 - 512		
		DMX MODE	1-CH		
			4-CH		
			7-CH		
	PERSONALITY	MagApp Set	MagApp Name		
			MagApp Pass-code		
			MagApp IP		
			MagApp Port		
			MagAppReset	Complete	
				Failed, try again	
		MagApp > DMX & Magfly	On / Off	Allows APP data to be converted to DMX data and then sent out via DMX port and Magfly	
		LCD Set	Screen OFF	Never	
				10s	
				40s	
				1 min	
				2 min	
				5 min	
				10 min	
			20 min		
		Display Flip	0 deg / 180 deg		
		Magfly Set	Magfly Channel	0 - 14	When Magfly is not equipped, selecting this function causes "Optional Module Not Installed" to show on the screen.
Magfly	ON / OFF				

CONTINUED ON NEXT PAGE

SYSTEM MENU

	PERSONALITY (cont'd from prev page)	MagRF Learn	Frequency Matching feature. Display will read "Connected" if connection attempt succeeds within 20 seconds. Otherwise, display will read "Connection Failed."	When Magfly is not equipped, selecting this function causes "Optional Module Not Installed" to show on the screen.
		Last State	Yes / No	When powered up, device adheres to last settings used before power was shut off
		Default	Yes / No	Restore to factory settings
	MANUAL		LED Off	
			Intensity 0% - 100%	
	TIMER	Interval	0 - 2500 s	Start or pause device operation according to these values by pressure the Play/Stop icon.
		Duration	0 - 250 s	
			LED Off	
			Intensity 0% - 100%	
			Auto 1-4	
	PRESET	OPT Effect	OPT1	Adjusts fog hang time.
			OPT2	
			OPT3	
			OPT4	
CONTINUED ON NEXT PAGE				

SYSTEM MENU

	PRESET (cont'd from prev page)	LED Status	On	LED on
			Follow	LED illuminates in sync with fog output
			Off	LED off
		LED Bright	0% - 100%	
		LED Effect	Off	Special effects
			Random	
			Pulse	
			Strobe	
		LED Style	LED Off	Manual fogging effects
			Auto 1-4	
			Color 1-50	
		MagRF1 Style	LED Off	Wireless Remote Button A
			Auto 1-4	
			Color 1-50	
MagRF2 Style	LED Off	Wireless Remote Button B		
	Auto 1-4			
	Color 1-50			
MagRF3 Style	LED Off	Wireless Remote Button C		
	Auto 1-4			
	Color 1-50			
MagRF4 Style	LED Off	Wireless Remote Button D		
	Auto 1-4			
	Color 1-50			
	INFORMATION	State	Normal / Error	
		Slot 1	Null	
			MagFly	
			MagApp	
			MagRF	
		Slot 2	Null	
			MagFly	
			MagApp	
MagRF				
CONTINUED ON NEXT PAGE				

SYSTEM MENU



INFORMATION
(cont'd from prev page)

		Last Control	LCD_auto	Displays current source of device control
			LCD_manual	
			DMX	
			MagApp	
			MagRF	
			MagRemote	
			Error	
		MagRemote State	Yes / No	Displays whether MagRemote control is connected
		MagApp Connect	Null	No available MagApp source
			Phone	Mobile phone MagApp source
			Route	Router MagApp source
			No	MagApp module not installed
		MagApp IP	Display shows "No" if MagApp module is not installed	
		MagFly CH	0 - 14	
		DMX Addr	1 - 512	
		DMX Mode	1 / 4 / 7	
		Timer Int	0s - 2500s	
		Timer Dur	0s - 250s	
		Heating	0% - 100%	
		Heater State	Normal	
Error				
No Heat				
LCD Ver	Vx.x			
Sftwr Ver	Vx.x			

DMX CHANNEL FUNCTIONS & VALUES

CHANNEL			VALUES	FUNCTION
1-CH	4-CH	7-CH		
1	1	1		Fog
			000 - 009	Off
			010 - 127	LED On (1-second delay after start of fog burst)
			128 - 255	Max Fog Output, LED On
	2			Macro
			000 - 004	LED Off
			005 - 154	Macro 1 - Macro 50 (see Macro Table)
			155 - 180	Fog burst & lighting display loop (2s cycle)
			181 - 205	Fog burst & lighting display loop (1s cycle)
			206 - 230	Auto Mode 2
			231 - 255	Auto Mode 1
		2	000 - 255	Red, 0% - 100%
		3	000 - 255	Green, 0% - 100%
		4	000 - 255	Blue, 0% - 100%
		5	000 - 255	Amber, 0% - 100%
	3	6		Flash
			000 - 031	Off
			032 - 095	Random Strobe, slow to fast
			096 - 159	Pulse, effect in sequence
			160 - 255	Strobe effect, slow to fast
	4	7		Dimmer
			000 - 003	Off
			004 - 255	Dimmer, 1% to 100%

MACRO TABLE

MACRO NO.	DMX VALUES	MACRO NO.	DMX VALUES
1	005 - 007	26	080 - 082
2	008 - 010	27	083 - 085
3	011 - 013	28	086 - 088
4	014 - 016	29	089 - 091
5	017 - 019	30	092 - 094
6	020 - 022	31	095 - 097
7	023 - 025	32	098 - 100
8	026 - 028	33	101 - 103
9	029 - 031	34	104 - 106
10	032 - 034	35	107 - 109
11	035 - 037	36	110 - 112
12	038 - 040	37	113 - 115
13	041 - 043	38	116 - 118
14	044 - 046	39	119 - 121
15	047 - 049	40	122 - 124
16	050 - 052	41	125 - 127
17	053 - 055	42	128 - 130
18	056 - 058	43	131 - 133
19	059 - 061	44	134 - 136
20	062 - 064	45	137 - 139
21	065 - 067	46	140 - 142
22	068 - 070	47	143 - 145
23	071 - 073	48	146 - 148
24	074 - 076	49	149 - 151
25	077 - 079	50	152 - 154

DIMENSIONAL DRAWINGS

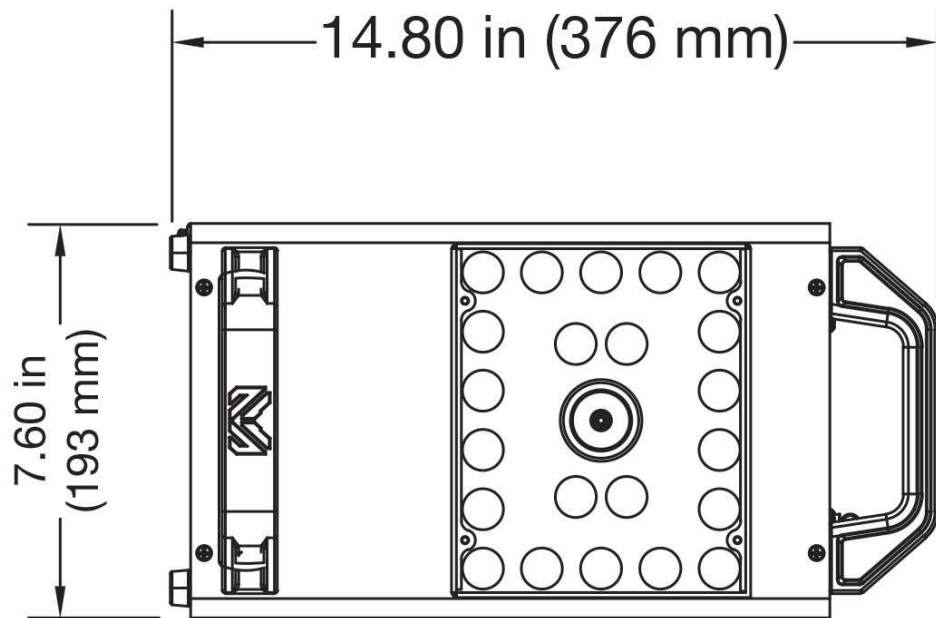
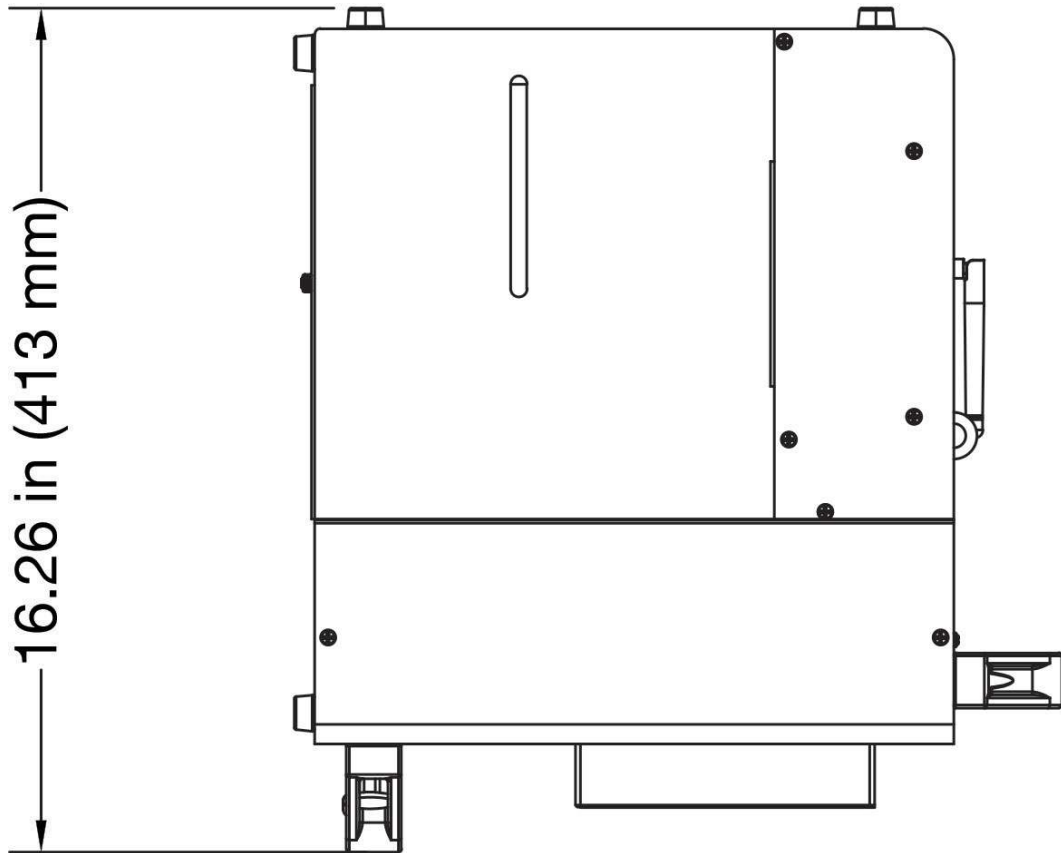

Dimensions may not be drawn to scale.

TROUBLE SHOOTING

If you experience low output, pump noise, or no output at all, disconnect the device and discontinue use immediately. Do not attempt to continue operation as this may damage the machine. Check the fluid level, the breaker, and the wall outlet to make sure that it is sending power. If all the above factors do not appear to be causing the issue, and the unit still fails to operate correctly, the unit will require service. Please contact Magmatic Effects for assistance.

CLEANING & MAINTENANCE

When storing your device, be sure to store in a cool area. Cover the device so that dust does not build up on the device. When storing for long periods of time it is highly advisable to run the device at least once every 3-4 months. Long periods of inactivity can severely shorten the life of your device. **Only run Magmatic's Atmosity fluid (SKU# AFF) through your machine.** Never run plain water, vinegar, or any other liquid solution through your device, as doing so will severely damage your device.

SPECIFICATIONS

PERFORMANCE

Rated Power: 1450W
Max Output: 50,000 CFM* (cu ft/min.)
Max Continuous Output: 8 Seconds @ Full
Max Throw Distance: 25 Feet
Initial Ready Time: 9 Minutes
Cycling Ready Time: 1 Minute
Fluid Capacity: 2.5L
Fluid Consumption: 180ml/min.

COMPATIBLE FLUID

Atmosity Flash Fog Fluid (AFF-4L)
Atmosity Extreme Filtered Fog Fluid (AEF-4L)

CONSTRUCTION

Thermally Protected Heat Exchanger
Advanced HPA (high pressure air) Pump Technology Energy Saving Mode with Auto-Clean Process Sealed Fluid Reservoir
External Visual Fluid Level Detection
Compact Light Weight Mobile Design

CONTROL

3 DMX Channel Modes (1 / 4 / 7)
Onboard LCD Touch Control Panel
DMX-512 and RDM Protocol Support
Optional MagFLY Wireless DMX Transceiver
Optional MagRF and Wired Remotes

CONNECTIONS

5-pin locking XLR, In/Out Data Connectors
IP65 Locking Input Power Connector
With Wired Digital Communication Network

SIZE / WEIGHT

Length: 16.26 in. (413mm)
Width: 7.60 in. (193mm)
Height: 14.80 in. (376mm)
Weight: 29.5 lbs. (13.4kg)

ELECTRICAL

Input Voltage: 120V, 230V, 240V 50/60Hz
Resettable Breaker (NFB): 20A (120V) / 10A (230V)
Max Power Consumption: 1560W

THERMAL

Maximum Ambient Temperature (Ta max) 104°F (40°C)
Exterior Surface Temperature, Steady State: 140°F (60°C)

APPROVALS / RATINGS

CE | cETLus (pending) | IP20

Specifications are subject to change without notice.

MAGFLY MODULE



SHORT ANTENNA INSTALLED



LONG ANTENNA INSTALLED



SPECIFICATIONS

2.4 GHz Wireless Frequency

450m Effective Distance (open space with clear line of sight from transmitter to receiver)

Wireless DMX Function

Without Antenna:

Dimensions (LxWxH): 3.1" x 2.2" x 0.8" (80mm x 56mm x 21mm)

Weight: 3.2 oz (90g)

With Long Antenna:

Dimensions (LxWxH): 6.7" x 2.2" x 0.8" (169mm x 56mm x 21mm)

Weight: 3.5 oz (98g)

With Short Antenna:

Dimensions (LxWxH): 3.6" x 2.2" x 0.8" (91mm x 56mm x 21mm)

Weight: 3.3 oz (93g)

MAGFLY MODULE

OPERATION

1. Attach either of the included antennas to the MagFly module, then locate the card input slots on your Magmatic device. Use a screwdriver to remove the slot cover for one of the input slots, then insert the MagFly module and fasten it in place with the module's mounting screws.



2. Check the display screen on your Magmatic device. The MagFly icon should appear at the top of the screen, as shown below.

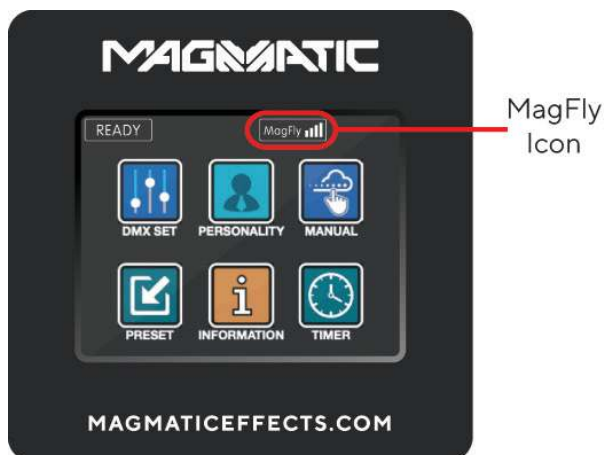

3. Select the Personality icon on your Magmatic device's touch screen, then select the "MagFly Set" option to configure your MagFly module. Refer to your the **System Menu** section of this manual for detailed information.
4. Use the UP and DOWN keys to scroll to the "MagFly On/Off" option. Select this option, and switch this setting to ON.
5. Return to the "MagFly Set" menu, and use the UP and DOWN keys to scroll to and select the "MagFly Channel" option. Selectable values range from 0 to 14.
6. The MagFly module is now configured and ready to use. Please note, the MagFly module automatically switches between sending or receiving data, depending on whether a data input signal is detected at the device's DMX port.

MAGRIF MODULE

RECEIVER

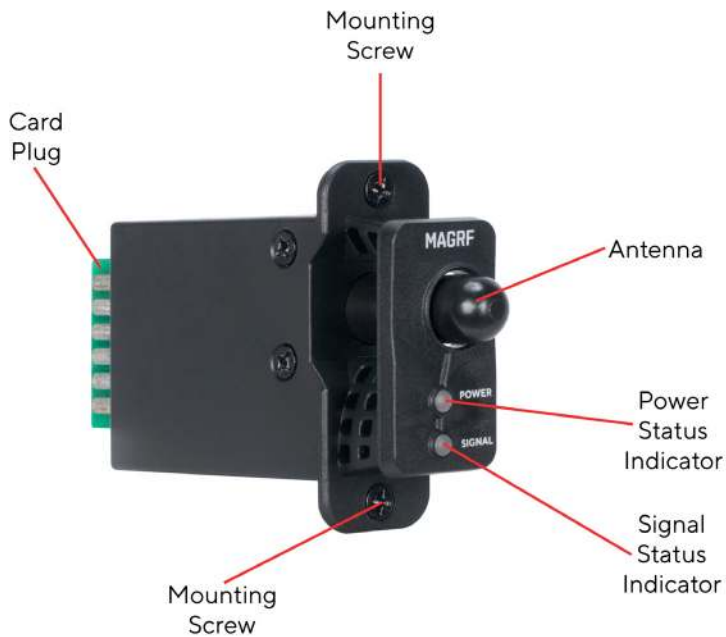

TRANSMITTER



SPECIFICATIONS

433 MHz Wireless Frequency

50m Effective Distance (open space with clear line of sight from transmitter to receiver)

Function varies with Magmatic fixture model

27A / 12V Transmitter Battery

Receiver Dimensions (LxWxH): 3.4" x 2.2" x 0.8" (86mm x 56mm x 21mm)

Receiver Weight: 1.1 oz (32g)

Transmitter Dimensions (LxWxH): 2.6" x 1.4" x 0.6" (65mm x 36mm x 15mm)

Transmitter Weight: 1.3 oz (36g)

MAGRIF MODULE

OPERATION

1. Locate the card input slots on your Magmatic device. Use a screwdriver to remove the slot cover for one of the input slots, then insert the MagRF module and fasten it in place with the module's mounting screws.



2. Check the display screen on your Magmatic device. The Bluetooth icon and the letters "RF" should appear at the top of the screen, as shown below.

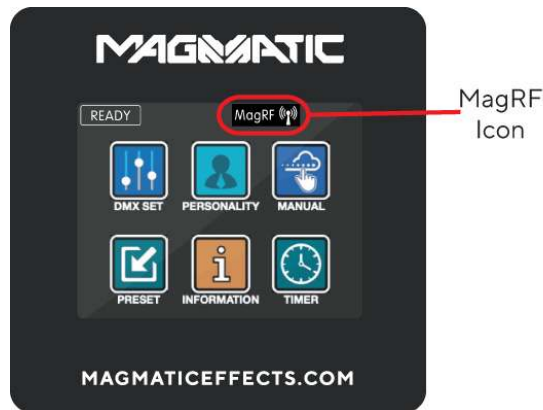

3. Select the Personality icon on your Magmatic device's touch screen, then select the "MagRF Learn" option. Press any of the four keys on the transmitter to pair the transmitter. If pairing is successful, a notification reading "Connected" will appear. On the other hand, if no action is taken within 20 seconds, or if pairing is unsuccessful, a prompt reading "Connection Failed" will appear.
4. After the receiver and transmitter are paired, the transmitter can be used to control the operation of the device. The assigned functions of each of the four keys on the transmitter vary with the particular device model. See your device's user manual for information.

FCC STATEMENT

This device complies with Part 15 of the FCC rules. Operation is subject to the following two conditions: (1) this device may not cause harmful interference, and (2) this device must accept any interference received, including interference that may cause undesired operation.

FCC RADIO FREQUENCY INTERFERENCE WARNINGS & INSTRUCTIONS

This equipment has been tested and found to comply with the limits for a class B digital device, pursuant to part 15 of the FCC Rules. These limits are designed to provide reasonable protection against harmful interference in a residential installation. This device uses and can radiate radio frequency energy, and if not installed and used in accordance with the included instructions, may cause harmful interference to radio communications. However, there is no guarantee that interference will not occur in a particular installation. If this device does cause harmful interference to radio or television reception, which can be determined by turning the device off and on, the user is encouraged to try to correct the interference by one or more of the following methods:

- Reorient or relocate that device.
- Increase the separation between the device and the receiver.
- Connect the device to an electrical outlet on a circuit different from the one connected to the radio receiver.
- Consult the dealer or an experienced radio/TV technician for help.

Please note that the changes or modifications of this product that are not expressly approved by the party responsible for compliance could void the user's authority to operate the equipment.



