

Quick Start Guide

FULL HD Doorbell Camera

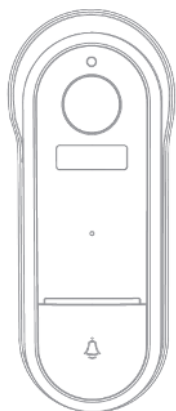





Model: 43061068

Bell 15S

v1.0 30/03/2021

Welcome, Thank you for choosing our smart camera, getting started is easy

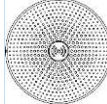
What's included

| | | | |
|--|---|---|---|
|  |  |  |  |
| Bell 15S | USB charging cable | USB chime | Wall mount screw sets |

Commented [b1]: 1.Double check if Welcome keep blod font, 2.The T of thank you if need lower-case

Commented [b2]: There not use blod font, if add?

Commented [b3]: Pls use new chime pic as attached.

Product Details

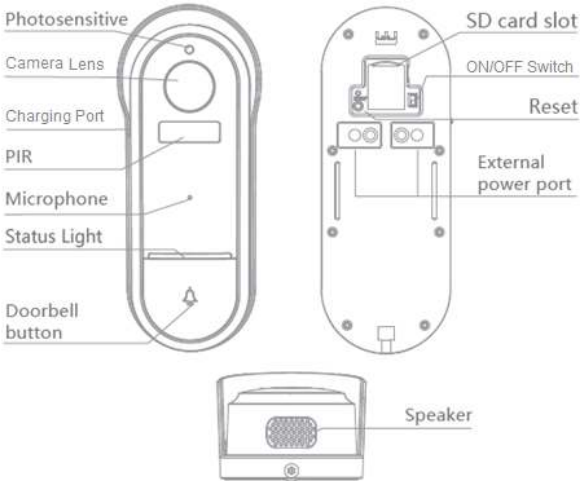

Connection Preparation

It is important that your phone is connected to the 2.4Ghz Wi-Fi and not to the 5GHz network.

To verify your mobile device is set to a 2.4Ghz Wi-Fi network, navigate to the **Settings** menu and click on **Wi-Fi**. In this menu you will see all the detectable networks in your area. Locate the SSID (the name of your network) and ensure that the Wi-Fi SSID does not end with a 5G / 5GHz.



Check that you have a strong Wi-Fi signal (at least two bars) in the location where the smart camera is to be installed. 

If you don't have at least two bars signal on your phone, then you may need to reconsider relocating the camera to a different location or obtain a Wi-Fi extender to boost the Wi-Fi signal strength.

1. Install the APP and register Account

Download the "Mirabella Genio" APP to your smartphone from the App Store or Google Play.

Insert the Micro SD card (not included) (Please note that the camera will work without an SD card, but it will not be able to record any footage.)

Remove the rubber cap to expose the SD card slot, insert the Micro SD card gently into the SD card slot. Please pay attention to the direction of the Micro SD card. Do not force it inside, once inserted, refit the rubber cap.

Micro SD card size needs >8GB, Support up to Max of 128Gb, FAT32 format only, The camera doesn't support NTFS file system.



We recommend use Scandisk, Verbatim, Kingston, Samsung Class 10 high speed micro SD for best performance.

Recharging the battery, remove the plastic cover on the side, to expose the charging port, insert the supplied USB cable and standard phone charger 5V 1A (not included) to charge the battery



Commented [b4]: The S of support if need lower-case

Commented [b5]: The T of the if need lower-case

2. Doorbell Camera Installation

Commented [b6]: For AC supply pls revise the new attached one

Mode 1 Battery supply

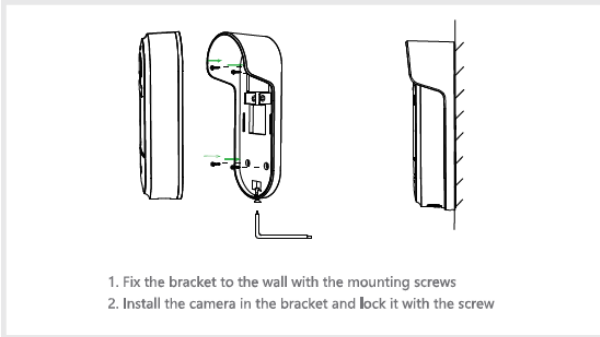

Mode 2 AC supply (optional)

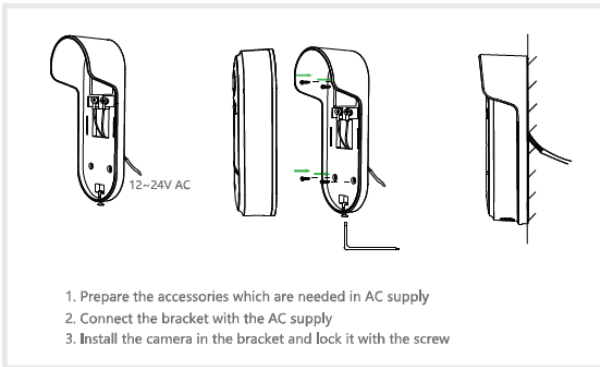

3. Pairing the camera using Mirabella Genio App

1. Remove the plastic cover on back to expose the ON/OFF switch, slide the switch to ON.



2. Press the doorbell button, wait for 6-30 seconds, the outer ring on the doorbell button will start to blink red slowly, (1 blink every two seconds) if it is blinking fast (2 blinks per second) rather than slowly, you will need press and hold the reset button until you hear a sound, then the LED will now start to blink RED slowly. (1 blink every two seconds).
3. Please ensure your mobile phone is connected to your 2.4Ghz Wi-Fi network (DO NOT use Wi-Fi name ending with -5G)

4. Open the Mirabella Genio APP, tap on +, then choose **Security & Sensor**

Select your **doorbell camera** from the list of smart camera icon

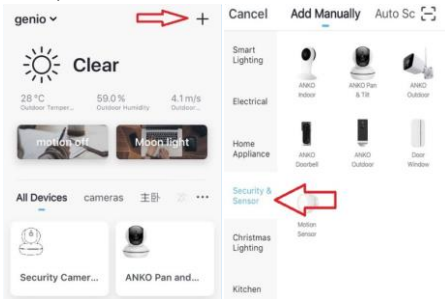

Commented [b7]: If as below is better, delete the comma, add the full stop

the outer ring on the doorbell button will start to blink red slowly(1 blink every two seconds).

Commented [b8]: if → if

May need recheck the capital and small letter in whole Manuals

Commented [b9]: Will now ? if delete the now ?

Commented [b10]: Attention, have Chinese words

- Double check and ensure that the LED indicator light is still red and blinking **slowly**, tap **confirm blinking slowly** and enter your 2.4GHz Wi-Fi name and password

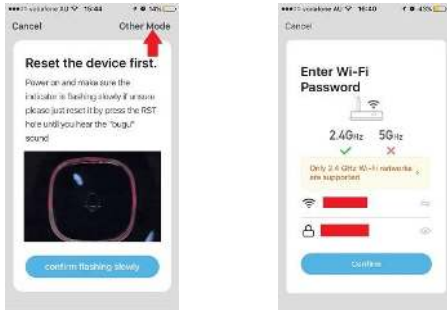

- Tap **continue** and the QR code will appear, place this QR code in front of the camera at approximate 15-20cm, until you hear a sound, the indicator light will now change from blinking red to blinking blue

Use Camera to Scan Q...

Tap Next. The mobile phone displays a QR code. Use the camera to scan to the QR code 15 cm to 20 cm away from the mobile phone.



15-20cm

Continue



Wait for audio signal...

example of how to scan QR code
QR code is the code on your phone screen,
not the barcode on the camera box

7. Please wait for indicator light to switch to solid blue, then tap the **beeped/indicator switch** button
8. Camera is now successfully added into your APP. **Please refer to the FAQ section for troubleshooting if this method does not connect.**

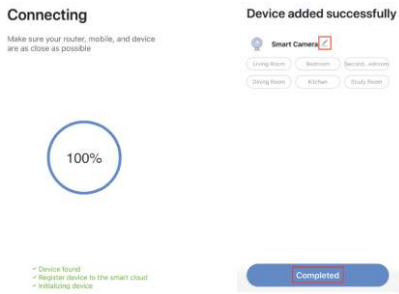

Q. LED indicator is not blinking slowly as per APP screen

A. Power off the camera, wait for 20 seconds, then power on. Use the depress the reset button until you hear a sound, then indicator light starts to blink red slowly (1 blink every two seconds).

Q. Camera doesn't scan the QR code

A. Please ensure camera is in the pairing mode, indicator light is blinking red slowly as per APP screen, if you are unsure, please reset it

Q. After scanning the QR code, indicator light doesn't turn into solid blue

A. This is an indication of communication error with router, please ensure you are using the correct 2.4Ghz Wi-Fi name and password, and please manually disabled the 5GHz Wi-Fi signal on the router setting

Q. I am using Telstra NBN, I disabled the 5Ghz and I still cannot get it to pair?

A. Please try follow the Guest Network pairing instructions at <https://mirabellagenio.net.au/faqs>

Note: rechargeable battery can be recharged with supplied USB cable and standard 5V 1A mobile phone USB adaptor (not included)

4. Pairing the Wireless Chime

1. Insert the chime into any standard USB outlet or adaptor (not included), the chime needs to be in 5 metres range of the doorbell

2. Open the Mirabella genio APP, tap on doorbell ->setting-> **bell setting**
>choose Wireless Chime or Chime Type , select **Wireless Chime**

Commented [b11]: Below pic without bell setting, pic of page 11 have.

3. Press and hold the reset button on the back of the chime and ensure the blue indicator light is **continuously blinking for more than 10 seconds** before adding the chime. If it is not continuously blinking you will need to press and release the reset button again before proceeding to step 4

4. Return to setting -> **ring setting**-> tap on add, If you don't have **ring setting**, then go to **Bell Setting**,-> Bind



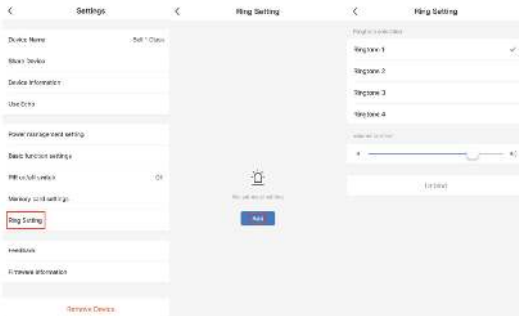

5. The indicator light on the chime will stop blinking as soon as you hit the **add or Bind**, the chime is paired successfully, and you can test it by press the doorbell button.



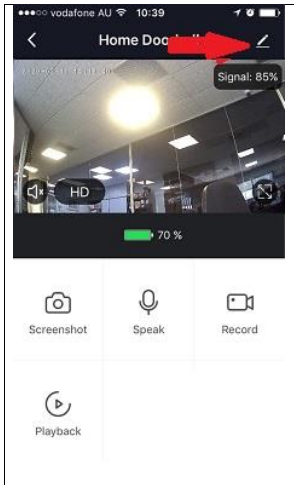

6. If the chime did not stop blinking, or no ring tone, please unbind the chime, then repeat step 2 to step 5.



Camera interface is subject to slight alterations based on firmware updates

Tap on the **pencil icon** or **... icon** you can access the camera's **Settings** page

| | |
|--|--|
|  | <p> Screenshot To take snapshot of the screen and save it to phone's camera roll</p> <p> Speak Tap to speak to the camera</p> <p> Record Record live footage into your phone's internal storage</p> <p> Playback Access to the footage recorded on the Micro SD card</p> |
|--|--|

| | |
|---|--|
|  | To turn sound on/ off |
|  | To change video quality , high definition or Standard definition |
|  | To access to camera's settings page |
|  | To switch to full screen view mode |
| <p>Signal: 92% : Wi-Fi signal, if signal is less than 60% you should consider changing the location or boost the Wi-Fi Signal using Wi-Fi extender</p> | |

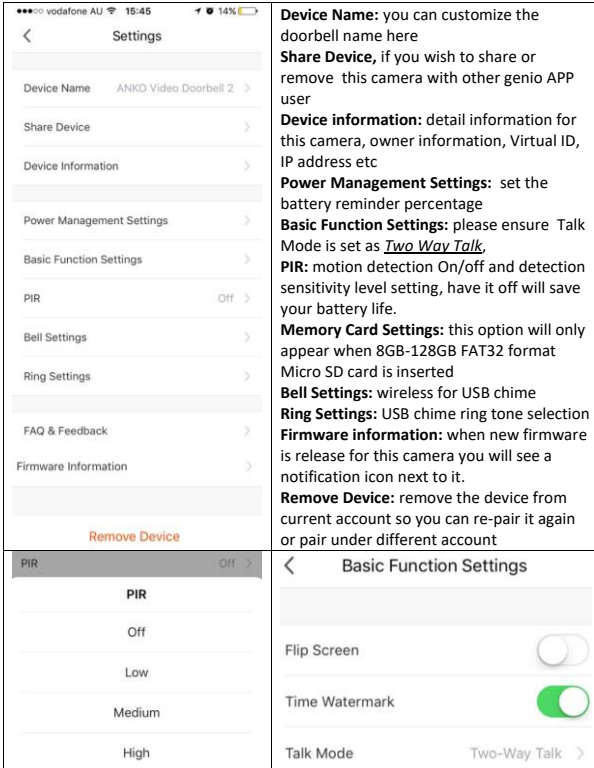

Device Name: you can customize the doorbell name here

Share Device, if you wish to share or remove this camera with other genio APP user

Device information: detail information for this camera, owner information, Virtual ID, IP address etc

Power Management Settings: set the battery reminder percentage

Basic Function Settings: please ensure Talk Mode is set as *Two Way Talk*,

PIR: motion detection On/off and detection sensitivity level setting, have it off will save your battery life.

Memory Card Settings: this option will only appear when 8GB-128GB FAT32 format Micro SD card is inserted

Bell Settings: wireless for USB chime

Ring Settings: USB chime ring tone selection

Firmware information: when new firmware is release for this camera you will see a notification icon next to it.

Remove Device: remove the device from current account so you can re-pair it again or pair under different account

FAQ:

How to connect camera to another router/genio account?

Go to the camera's settings page, look for "remove device" Remove it and reset the camera and pair it again through the APP.

Poor performance, takes a long time to load the live footage?

Please check the Wi-Fi signal, if it is less than 60%, you will need consider changing the camera location or purchase a Wi-Fi extender to boost the signal.

Camera goes offline and doesn't reconnect back?

Go to the camera's settings page, look for "remove device" Remove it and reset the camera and pair it again through the APP.

Still receive the Cannot find Device error?

Manually disable the 5Ghz Wi-Fi signal on the router setting

Ensure that the 2.4Ghz Wi-Fi signal is on.

Ensure the indicator light is blinking RED slowly as per APP screen (1 blinks 2 second)

Please check you have entered the correct 2.4Ghz Wi-Fi SSID and password

How to turn on or turn off notifications?

On the Genio APP home screen, Tap on **Me** -> **Settings** -> **Push Notification** -> turn on/off **Enable notifications**

How to change view or arrange device sequences and manage room?

A. In the genio APP home screen, tap on ... on the top right corner, to access these options , tap on family name to switch below rooms

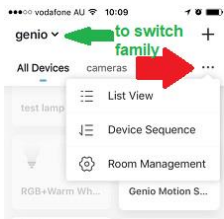

Q. Need more help or further technical assistance from Mirabella engineer?

A. In the genio APP home screen, tap on, **Me, -> FAQ & Feedback -> Report issue**

Fill the fault information or suggest for the APP/product, then submit

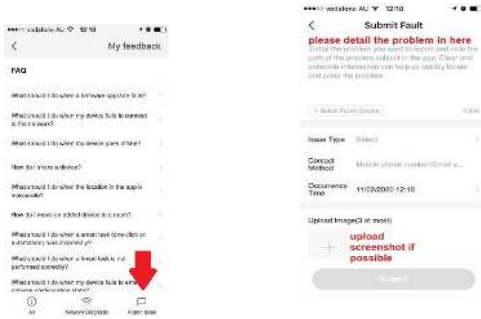

Remember the performance of Wi-Fi camera relies heavily on the performance of your router, If you are using Telstra NBN or a dual-band router, you must disable the 5GHz Wi-Fi in order to make a successful connection and for best overall performance, as **MOST smart products in Australia only work on the 2.4Ghz signal.**



All trademarks are used for reference purposes only. Made in China ANKO, HOME&CO AND AUDIOSONIC® ARE TRADEMARKS OF KMART AUSTRLIA LIMITED.

MIRABELLA INTERNATIONAL PTY LTD
1 MIRABELLA DRIVE, TULLMARINE, VIC, AUSTRALIA 3043
TOLL FREE: 1800 636 528, www.mirabellagenio.com.au

Commented [b12]: If the pattern of trash can is too small, it need arrive 7mm.

WARNING: Li-ion battery handling notice

Always read the instruction manual and any warnings on the device before using a lithium-ion battery.

Rechargeable lithium-ion batteries can explode, release flames, and/or cause burns if disassembled, punctured, cut, crushed, short-circuited, incinerated, recharged incorrectly, or exposed to water, fire, or high temperatures.

1. Use the battery charger and AC **adapter** specified for use with the lithium-ion battery.
2. Do not force the lithium ion battery into a battery charger or device if it does not fit.
3. Do not throw lithium-ion batteries into a fire or heat source also lead to overheating, explosion or fire.
4. Do not connect the positive and negative terminals of the lithium-ion battery with a metal object.
5. Do not throw lithium-ion batteries, drop them from high places, or otherwise subject them to strong impacts
6. Do not put a lithium-ion battery in a microwave oven, pressure container, or other such devices.
7. Do not place combustible materials on top of or over a lithium-ion battery when charging or discharging.
8. Do not disassemble or modify a lithium-ion battery.
9. When the electric device is not being used for an extended period of time, remove the lithium-ion batteries from the device and store them in a dry place.
10. Keep devices that contain batteries and batteries themselves out of reach of children. Mishandling of lithium-ion batteries is dangerous.
11. Lithium-ion batteries have finite life spans. If the batteries require constant recharging, replace them with new ones.
12. If battery leaks or gives off an unusual odour, immediately remove it and place it away from any naked flame.
13. Never dispose of a lithium-ion battery in your regular trash or recycling bin, contact your local council for recycling options

Commented [b13]: Adaptor and adapter not stay the same in whole manuals, pls choose one to use.