

Quick Start Guide

FULL HD Indoor Wi-Fi Camera

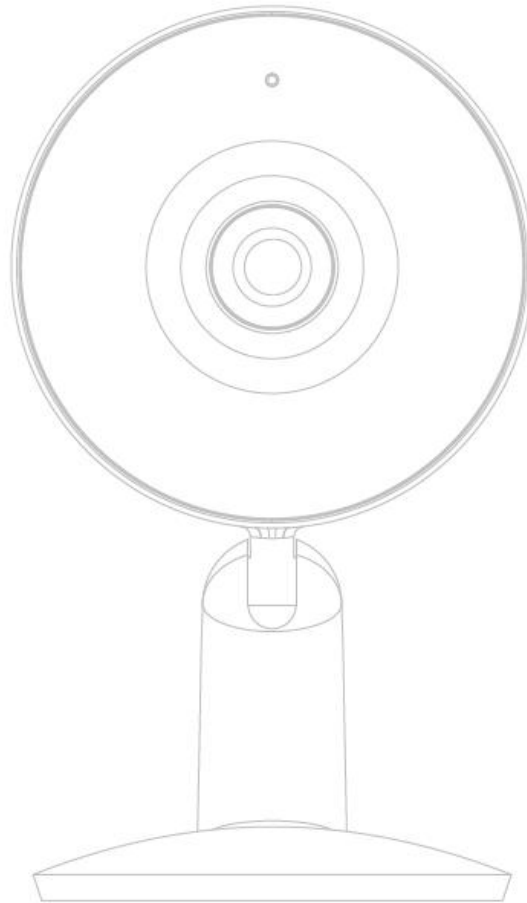



Model: Mini 16S

KEYCODE: I003968

v.2.0.0 26/03/2021

Welcome, Thank you for choosing our smart camera, getting started is easy

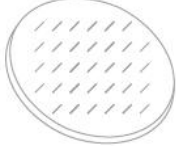
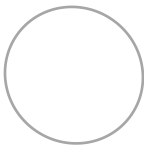
What's included

			
Mini 16S	Adhesive tape	Anti-slip pad	charging Cable

Product Details

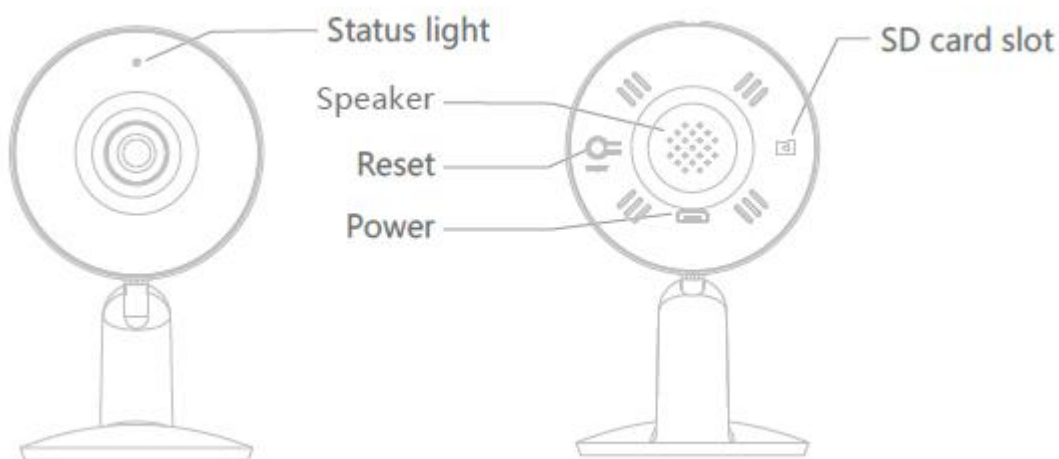

1. Connection Preparation

It is important that your phone is connected to the 2.4Ghz Wi-Fi and not to the 5GHz network.

To verify your mobile device is set to a 2.4Ghz Wi-Fi network, navigate to the **Settings** menu and click on **Wi-Fi**. In this menu you will see all the detectable networks in your area. Locate the SSID (the name of your network) and ensure that the Wi-Fi SSID does not end with a 5G / 5GHz.



Check that you have a strong Wi-Fi signal (at least two bars) in the location where the smart camera is to be installed. 📶 📶 📶 📶 📶

If you don't have at least two bars signal on your phone, then you may need to reconsider relocating the camera to a different location or obtain a Wi-Fi extender to boost the Wi-Fi signal strength.

2. Install the APP and register Account

For the best experience, download the "Mirabella Genio" APP to your smartphone from the App Store or Google Play.

3. Insert the Micro SD card

(Please note that the camera will work without an SD card, but it will not be able to record any footage.)

Remove the rubber cap to expose the SD card slot, insert the Micro SD card gently into the SD card slot. Please pay attention to the direction of the Micro SD card. Do not force it inside, once inserted, refit the rubber cap.

Micro SD card size needs >8GB, Support up to Max of 128Gb, FAT32 format only, The camera doesn't support NTFS file system.

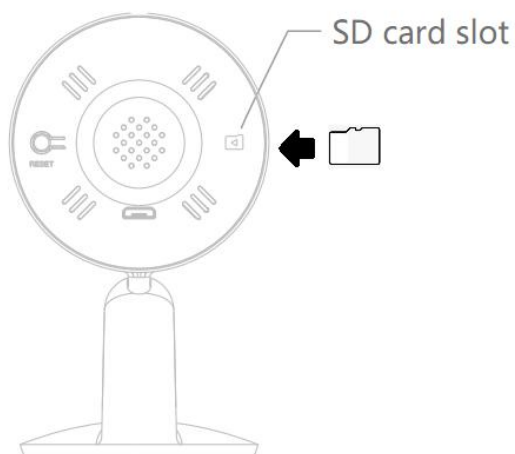

Camera Installation

1. Stick the adhesive tape to the camera base

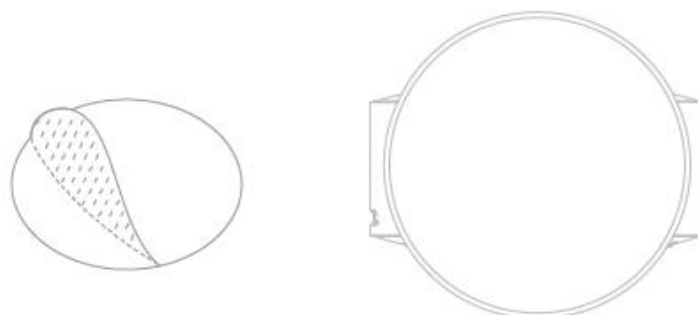

2. Place the camera in your preferred location, please ensure it is close to the router to get the optimum Wi-Fi signal coverage

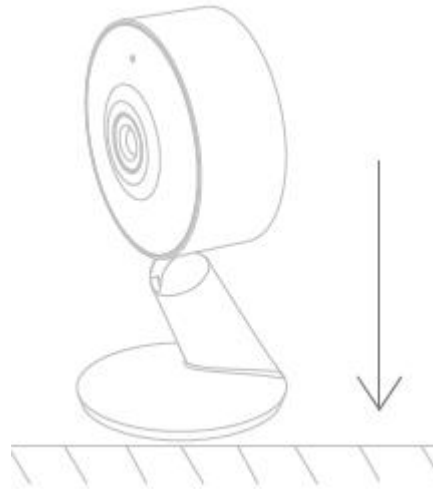

Pairing the camera using Mirabella Genio App

1. Connect the power adaptor to the camera, and switch on the power adaptor, wait for the indicator light to commence blinking RED rapidly (1 blink per second)
2. If it fails to blink red when powered on, Press and hold the reset button located on the back of camera, until you hear the “bugu” sound, then wait for the indicator light to blink red rapidly, once it is blinking red rapidly, your camera is ready to be paired to the app.
3. Open the Mirabella Genio APP, tap on +, then choose **Security & Sensor** and select your camera from the list

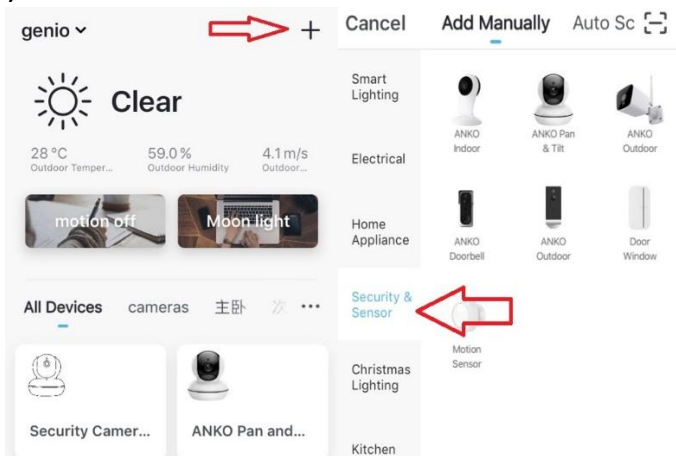

4. Double check and ensure that the LED indicator light is still blinking red rapidly, tap confirm blinking Fast and enter your 2.4GHz Wi-Fi name and password, then next

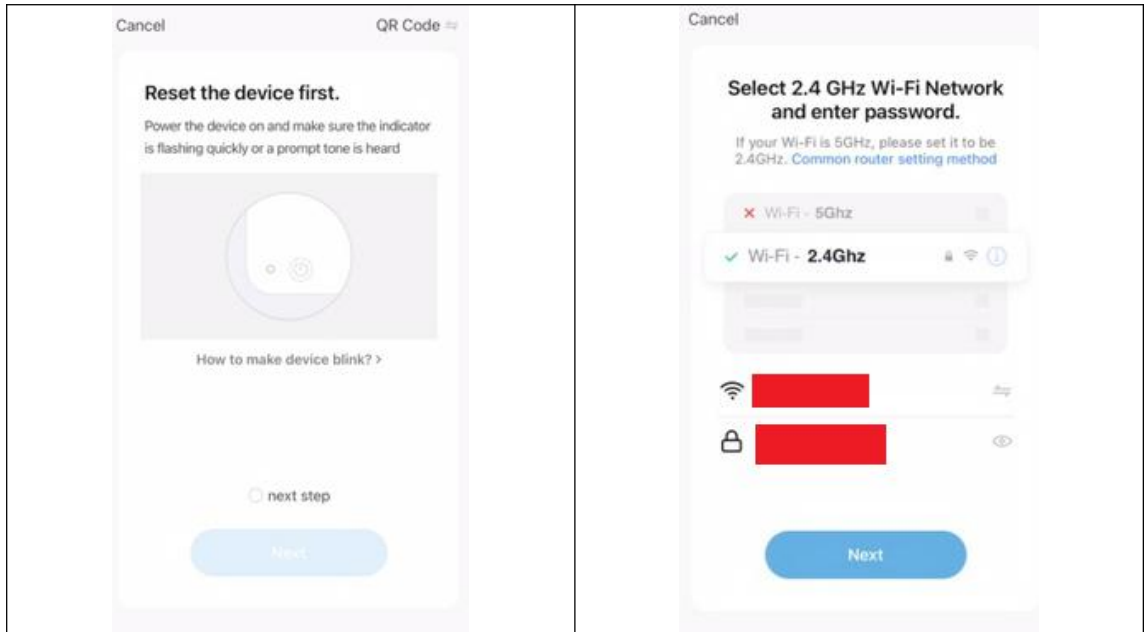



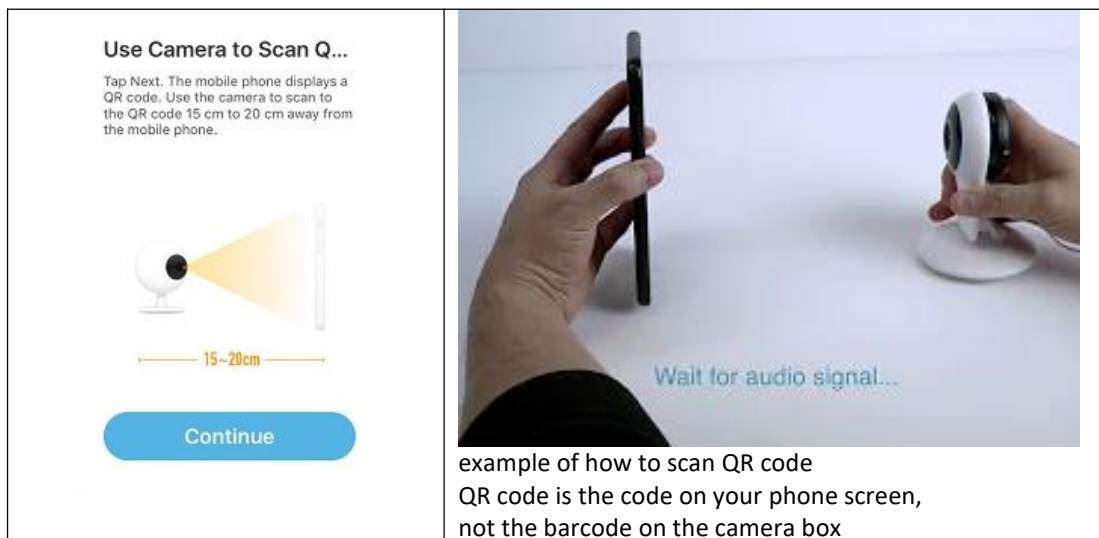





5. Tap continue and a QR code will appear on your phone screen, place this QR code in front of the camera at approximate 15-20cm (photo shown below), until you hear a sound, the indicator light will now change from red to blue. Please wait for indicator light became solid blue, then tap the beeped/indicator switch button

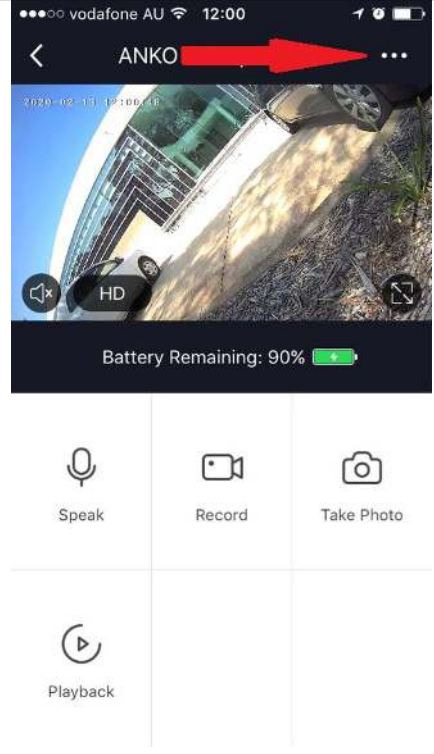

6. Camera is now successfully added into your APP. **Please refer to the FAQ section for troubleshooting if this method does not connect.**

Camera usage Tips (user interface may change with APP updates)

Tap on the **pencil icon** or **... icon** you can access the camera's **Settings** page

	<p> Speak Tap on and speak to your visitor (Two way talk must enable on basic function settings)</p> <p> Record Record live footage into your phone's internal storage</p> <p> Take Photo Take screenshots of current live footage</p> <p> Playback Access the footage recorded on the Micro SD card</p>
<p> To turn sound on/ off</p> <p> To change video quality , high definition or standard definition</p> <p> To access to camera's settings page</p> <p> To switch to full screen view mode</p> <p>Signal: 92%: Wi-Fi signal, if signal is less than 60% you should consider changing the location or boost the Wi-Fi Signal using Wi-Fi extender</p>	

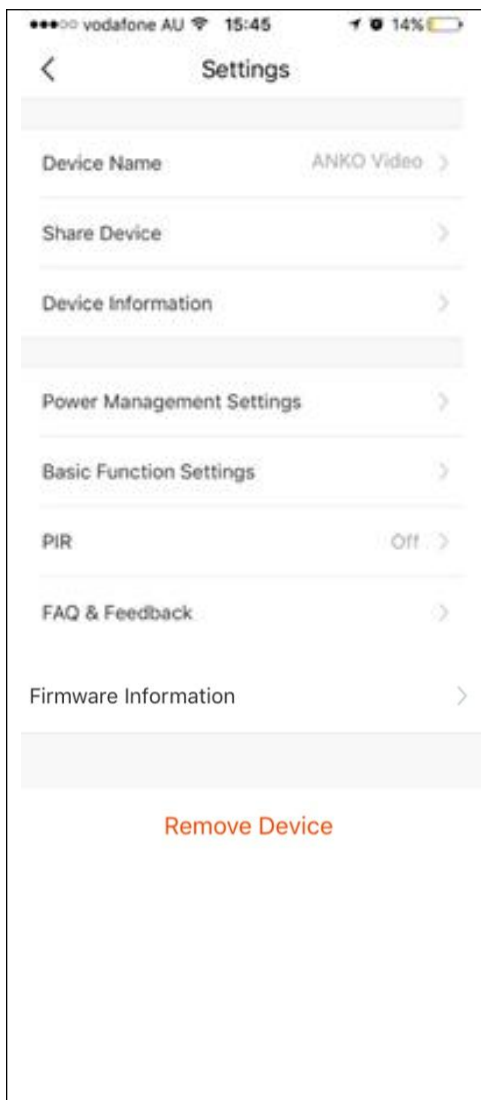

Device Name:

You can customize the camera name here

Share Device, If you wish to share or remove this camera with other genio APP user

Device information: Detail information for this camera, owner information, Virtual ID, IP address etc

Power Management Settings: Set the battery reminder percentage

Basic Function Settings: Please ensure Talk Mode is set as Two Way Talk,

PIR: Motion detection On/off and detection sensitivity level setting, have it off will save your battery life.

Memory Card Settings: This will only appear when 8GB-128GB Micro SD card is inserted

Firmware information: When new firmware is released for this camera you will see this notification icon.

Remove Device: Remove the device from current account so you can re-pair it again or pair under different account

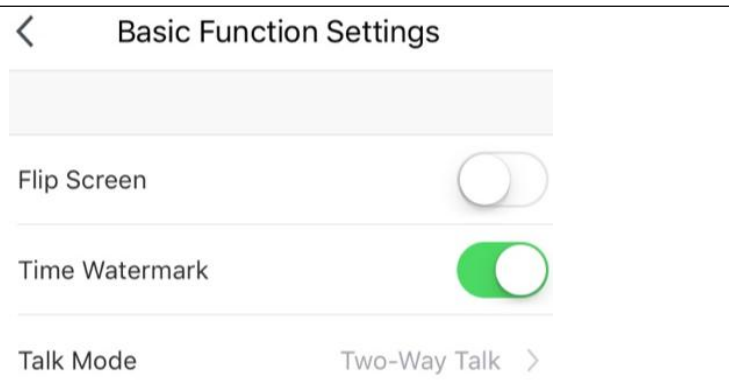
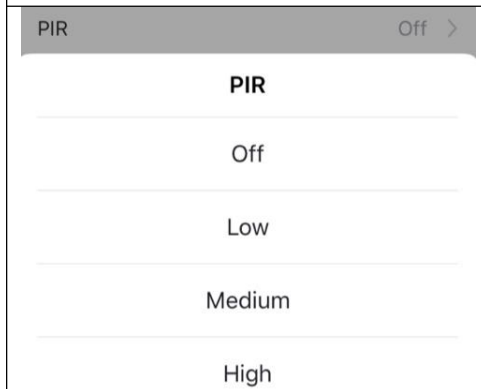

We recommend use Scandisk, Verbatim, Kingston , Samsung Class 10 high speed micro SD card for best performance.

Remember the performance of Wi-Fi camera is relies heavily on the performance of your router, If you are using Telstra NBN or a dual-band router, you must disable the 5GHz Wi-Fi in order to make a successful connection and for best overall performance, **as MOST smart products in Australia only work on the 2.4Ghz signal.**

FAQ:

How to connect camera to another router?

Go the camera' settings page, look for "remove device" Remove it and reset the camera and pair it again through the app.

Poor performance, take long time to load the live footage?

Please check the Wi-Fi signal, if it is less than 60%, you will need consider changing the camera location or purchase a Wi-Fi extender to boost the signal.

Camera went offline and doesn't reconnect back online by itself?

Go the camera' settings page, look for "remove device" Remove it and reset the camera and pair it again through the app.

Followed the pairing process but still receive the error Cannot find Device?

- Manually disable the 5Ghz Wi-Fi signal on the router setting
- Ensure that the 2.4Ghz Wi-Fi signal is on.
- Ensure the indicator light is blinking RED rapidly as per APP screen (1 blink per second)
- Please check you have entered the correct 2.4Ghz Wi-Fi SSID and password

How to turn on or turn off movement notification?

1. On the Genio APP home screen, Tap on **Me** -> **Settings** -> **Push Notification** -> turn on/off **Enable notifications**
2. On the iphone, **Settings** -> **Notifications** -> turn on/off **Allow Notification**

For multiple camera setup, change camera view or arrange device set up sequences and manage rooms?

On the genio APP home screen, tap on ... on the top right corner, to access these options , tap on V to switch below rooms

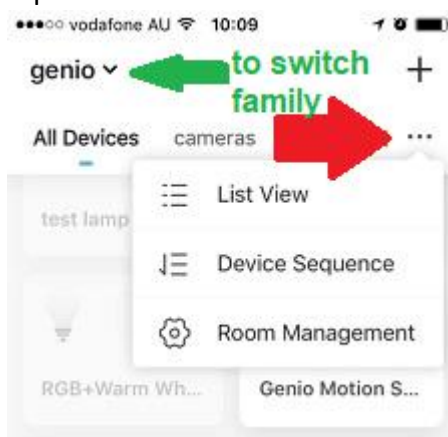

MIRABELLA INTERNATIONAL PTY LTD
1 MIRABELLA DRIVE, TULLMARINE, VIC, AUSTRALIA 3043
TOLL FREE: 1800 636 528, www.mirabellagenio.com.au