

**NANLITE**

*MixPad II 11C*  
USER MANUAL

Guangdong NanGuang Photo&Video Systems Co., Ltd



# MixPad II 11C RGBWW LED Panel Light

## ■ Product Diagram

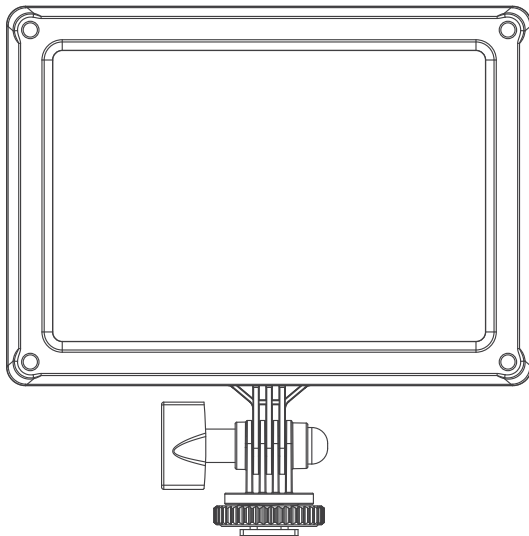

## ■ Technical Data

Rated Power: 13W

Input Voltage/Current: DC7.2-15V

Color temperature: 2700K-6500K

CRI: Average 95

TLCI: Average 98

## Product Details

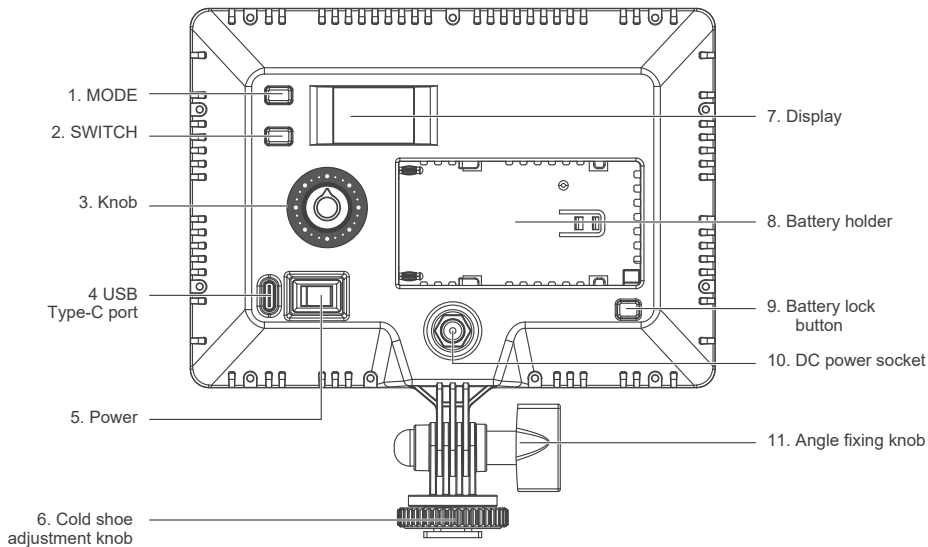

## Detailed Description

1. MODE: Switch between modes CCT-HARD, CCT-SOFT, HSI, EFFECT and MENU.
2. SWITCH: Switch selected options.
3. Knob: For selecting options and adjusting option values.
4. USB Type-C port: For firmware updates.
5. Power: Power on/off.
6. Cold shoe adjustment knob: For connecting the fixture on a light stand or on to camera equipments.
7. Display: Menu and option display.
8. Battery holder: For installing Sony NP-F, NP-FM lithium battery
9. Battery lock button: For locking or removing the battery.
10. DC power socket: DC power input port.
11. Angle fixing knob: For adjusting the illumination direction of fixture.

## Usage

### 1. Connection between the light fixture and power adapter

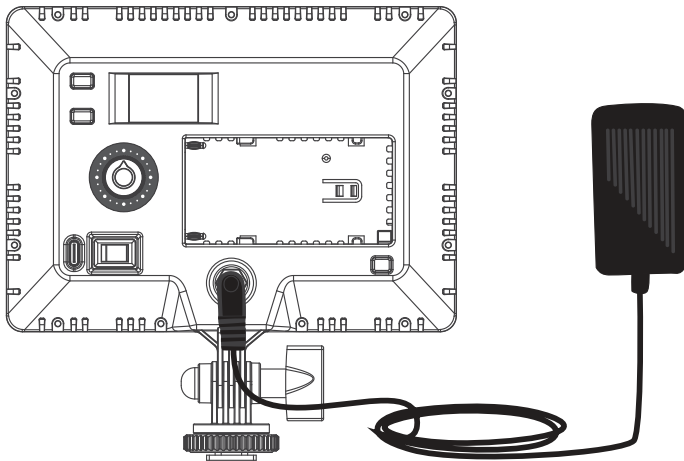

Note:

- ①When connect the power supply, please make sure the power and voltage should be consistent with the provide power supply.
- ②The power adapter is sold separately.

## 2. Connection between the light fixture and battery

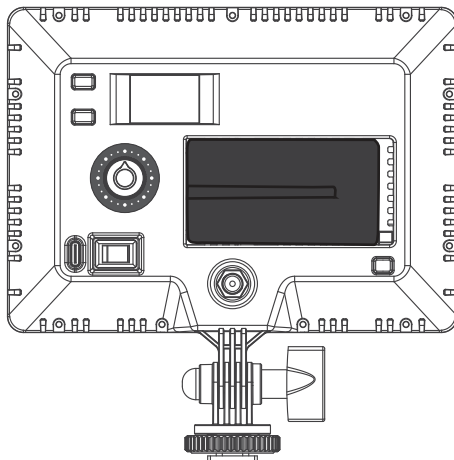

Note: The battery is sold separately.

## 3. MixPad II 11C has built-in bluetooth.

## Operating Instructions

1. Press "Power" button to turn on, "NANLITE" logo will be displayed on start up.

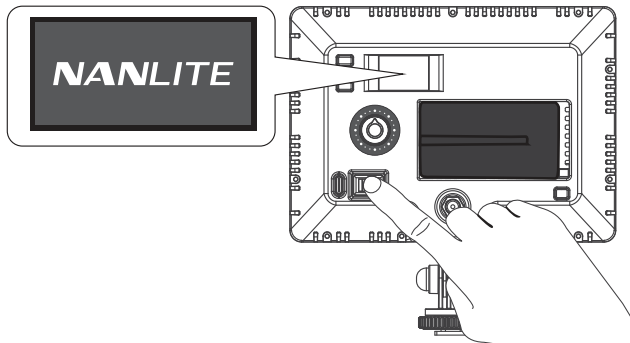

2. MODE button: Press to switch between modes CCT-HARD, CCT-SOFT, HSI, EFFECT and MENU.

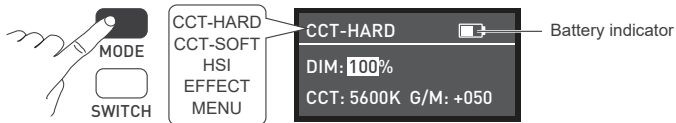

① CCT-HARD mode, press SWITCH button to select from DIM, CCT and G/M, rotate the knob to set the parameters of the corresponding options.

DIM rang: 000%...100%, CCT range: 2700K... 6500K, G/M range: -100...+100.



Press SWITCH button to select from DIM, CCT and G/M.



Rotate the knob to set the parameters of the corresponding options.

Note: In other modes, the adjustable range of DIM, CCT and G/M are the same as CCT-HARD mode.

② CCT-SOFT mode, press SWITCH button to select from DIM and CCT, rotate the knob to set the parameters of the corresponding options.



Press SWITCH button to select from DIM and CCT.

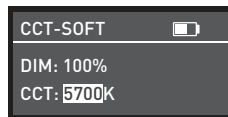
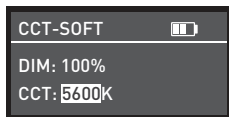
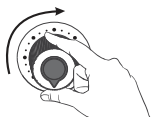

Rotate the knob to set the parameters of the corresponding options.

- ③ HSI mode, press SWITCH button to select from DIM, HUE and SAT, rotate the knob to set the parameters of the corresponding options.

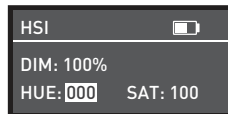
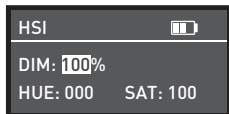
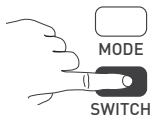

Press SWITCH button to select from DIM, HUE and SAT.

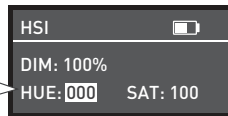
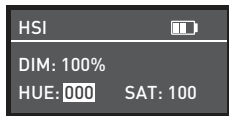
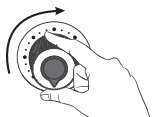

Rotate the knob to set the parameters of the corresponding options.

Note: In other modes, the adjustable range of DIM, HUE and SAT are the same as HSI mode.

④EFFECT mode, rotate the knob to select the desired special effect, it can be adjusted circularly.

MixPad II 11C has built-in effects including Hue Loop, CCT Loop, INT Loop, CCT Flash, Hue Flash, CCT Pulse, Hue Pulse, Storm, Police Car, TV, Paparazzi, Candle/Fire, Disco, Bad Bulb, Firework, Explosion and Welding.

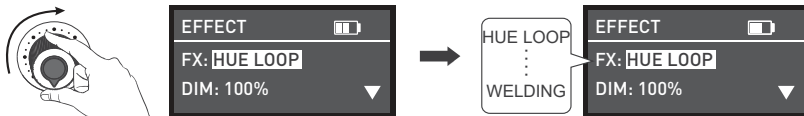

Rotate the knob to select the desired special effect.

(1) HUE LOOP

For HUE LOOP settings, press SWITCH button to select from DIM, HUE and SPD (SPD range: 02S...30S), rotate the knob to set the parameters of the corresponding options.



Press SWITCH button to select from DIM, HUE and SPD.



Rotate the knob to set the parameters of the corresponding options.

## (2) CCT LOOP

For CCT LOOP settings, press SWITCH button to select from DIM, CCT and SPD (SPD range: 02S...30S), rotate the knob to set the parameters of the corresponding options.



Press SWITCH button to select from DIM, CCT and SPD.



Rotate the knob to set the parameters of the corresponding options.

## (3) INT LOOP

For INT LOOP settings, press SWITCH button to select from DIM, SPD (SPD range: 02S...30S) and CLR (CCT and HUE), rotate the knob to set the parameters of the corresponding options.



Press SWITCH button to select from DIM, SPD and CLR.

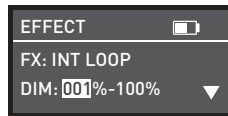
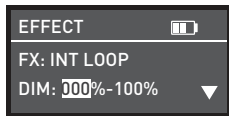
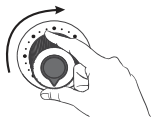

Rotate the knob to set the parameters of the corresponding options.

#### (4) CCT FLASH

For CCT Flash settings, press SWITCH button to select from DIM, CCT, G/M and INTVL  
(INTVL range: 0.1S...10.0S), rotate the knob to set the parameters of the corresponding options.

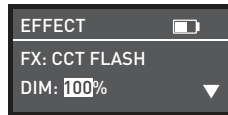
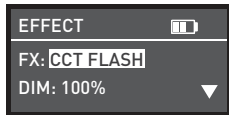
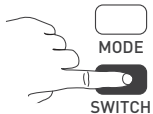

Press SWITCH button to select from DIM, CCT, G/M and INTVL.

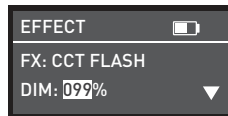
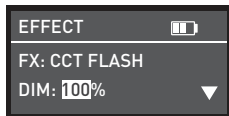

Rotate the knob to set the parameters of the corresponding options.

(5) HUE FLASH

For HUE FLASH settings, press SWITCH button to select from DIM, HUE, SAT and INTVL  
(INTVL range: 0.1S...10.0S), rotate the knob to set the parameters of the corresponding options.



Press SWITCH button to select from DIM, HUE, SAT and INTVL.



Rotate the knob to set the parameters of the corresponding options.

(6) CCT PULSE

For CCT PULSE settings, press SWITCH button to select from DIM, CCT, G/M and PULSES/M  
(PULSES/M range: 001...240), rotate the knob to set the parameters of the corresponding options.



Press SWITCH button to select from DIM, CCT, G/M and PULSES/M.

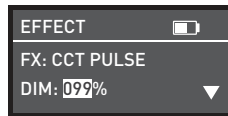
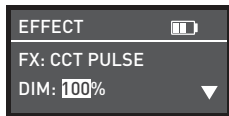

Rotate the knob to set the parameters of the corresponding options.

(7) HUE PULSE

For HUE PULSE settings, press SWITCH button to select from DIM, HUE, SAT and PULSES/M (PULSES/M range: 001...240), rotate the knob to set the parameters of the corresponding options.

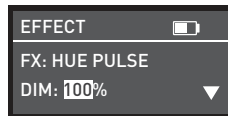
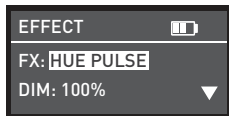
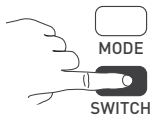

Press SWITCH button to select from DIM, HUE, SAT and PULSES/M.

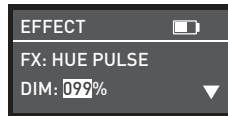
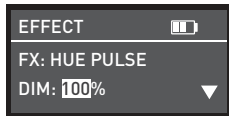

Rotate the knob to set the parameters of the corresponding options.

(8) STORM

For STORM settings, press SWITCH button to select from DIM, CCT and INTVL (INTVL range: 01S...60S), rotate the knob to set the parameters of the corresponding options.



Press SWITCH button to select from DIM, CCT and INTVL.



Rotate the knob to set the parameters of the corresponding options.

(9) POLICE CAR

For POLICE CAR settings, press SWITCH button to select from DIM, CLR (B/RB/BW/RBW) and SPD (SPD range: 001...100), rotate the knob to set the parameters of the corresponding options.



Press SWITCH button to select from DIM, CLR and SPD.

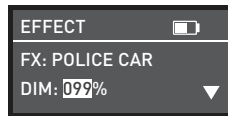
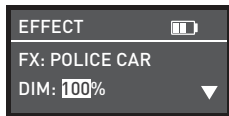

Rotate the knob to set the parameters of the corresponding options.

(10) TV

For TV settings, press SWITCH button to select from DIM, CCT, G/M and SPD (SPD range: 001...100), rotate the knob to set the parameters of the corresponding options.

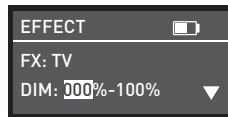
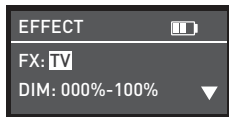
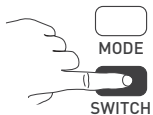

Press SWITCH button to select from DIM, CCT, G/M and SPD.

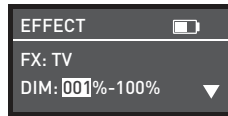
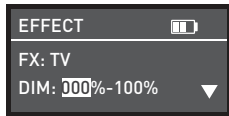
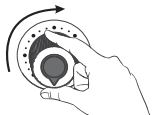

Rotate the knob to set the parameters of the corresponding options.

(11) PAPARAZZI

For PAPARAZZI settings, press SWITCH button to select from DIM, CCT, G/M and SPD (SPD range: 001...100), rotate the knob to set the parameters of the corresponding options.

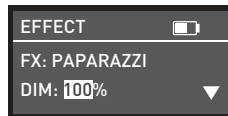
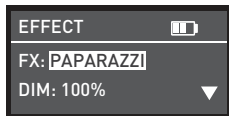
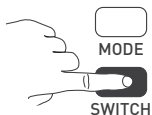

Press SWITCH button to select from DIM, CCT, G/M and SPD.

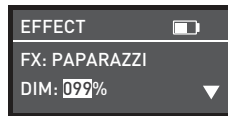
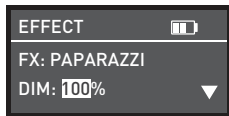

Rotate the knob to set the parameters of the corresponding options.

#### (12) CANDLE/FIRE

For CANDLE/FIRE settings, press SWITCH button to select from DIM, CCT, G/M and SPD  
(SPD range: 001...100), rotate the knob to set the parameters of the corresponding options.

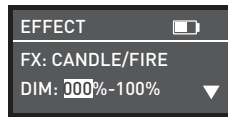
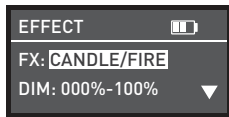
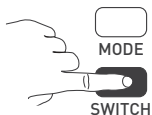

Press SWITCH button to select from DIM, CCT, G/M and SPD.

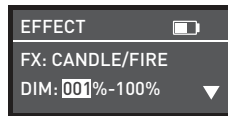

Rotate the knob to set the parameters of the corresponding options.

(13) DISCO

For DISCO settings, press SWITCH button to select from DIM, COLOR (COLOR range: 03, 06, 09, 12, 15, 18, 21, 24) and SPD (SPD range: 001...100), rotate the knob to set the parameters of the corresponding options.

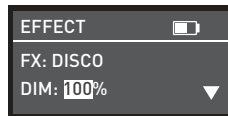
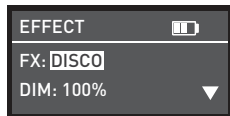
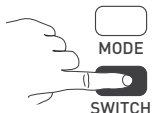

Press SWITCH button to select from DIM, COLOR and SPD.

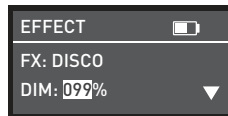
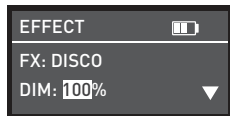

Rotate the knob to set the parameters of the corresponding options.

(14) BAD BULB

For BAD BULB settings, press SWITCH button to select from DIM, CCT, G/M and SPD  
(SPD range: 001...100), rotate the knob to set the parameters of the corresponding options.



Press SWITCH button to select from DIM, CCT, G/M and SPD.



Rotate the knob to set the parameters of the corresponding options.

(15) FIREWORK

For FIREWORK settings, press SWITCH button to select from DIM, COLOR (COLOR range: 03, 06, 09, 12, 15, 18, 21, 24), SPD (SPD range: 001...100) and DECAY (DEACY range: 001...100), rotate the knob to set the parameters of the corresponding options.



press SWITCH button to select from DIM, COLOR, SPD and DECAY.

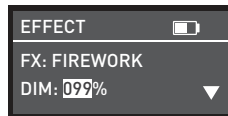
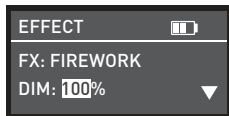

Rotate the knob to set the parameters of the corresponding options.

(16) EXPLOSION

For EXPLOSION settings, press SWITCH button to select from DIM, CCT, G/M, SPD (SPD range: 001...100) and DECAy (DECAy range: 001...100), rotate the knob to set the parameters of the corresponding options.

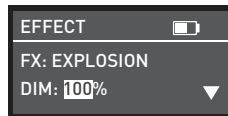
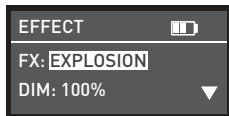
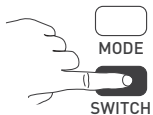

Press SWITCH button to select from DIM, CCT, G/M, SPD and DECAy.

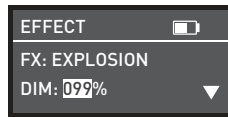
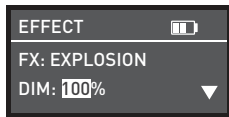

Rotate the knob to set the parameters of the corresponding options.

(17) WELDING

For WELDING settings, press SWITCH button to select from DIM, CCT, G/M, SPD (SPD range: 001...100) and PAUSE, rotate the knob to set the parameters of the corresponding options. The Pause includes "OFF" and "ON". When the status is "ON", the fixture will go out.



Press SWITCH button to select from DIM, CCT, G/M, SPD and PAUSE.



Rotate the knob to set the parameters of the corresponding options.

⑤ MENU

Press SWITCH button to select from CH, LANGUAGE and VERSION, rotate the knob to set the CH (001...512), set the LANGUAGE (Chinese and English) and check the firmware version of your fixture.



Press SWITCH button to select from CH, LANGUAGE and VERSION.

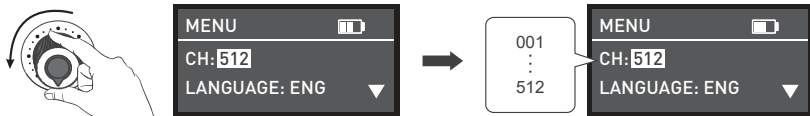

Rotate the knob to set the needed options.

- Lighting effects and additional functionality maybe added with future firmware releases, for details of these please see [www.nanlite.com](http://www.nanlite.com).

3. Press power button to turn off the light.



## Safety Precautionsc

1. Please open the package to check for damage caused in transit, if damaged please do not use and contact place of purchase or manufacturer as soon as possible.
2. Do not use a power cord with damaged insulation. Do not unplug hard or drag the power cord directly.
3. Make sure that the power supply voltage used matches the voltage specified by the light before installation.
4. When cleaning or not using the light, please turn it off.
5. Keep the light safely stored and away from children.

## Notice

1. Do not place any object on the light emitter.
2. Keep the light away from direct contact with liquids.
3. Don't place the light near flammable substances like alcohol or gasoline.
4. When cleaning the light, please wipe off debris or dirt by using a dry cloth with clean water or neutral cleanser.
5. The light should be operated safely where it won't be at risk of getting wet or under extreme temperature.
6. Don't repair the light by yourself. Attempts to self repair will void warranty, for repairs please return to place of purchase.

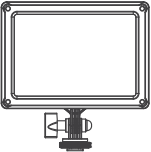
## What's in the box? Please kindly check.

MixPad II 11C×1	User Manual×1
	

## General Fault Detection and Diagnosis

Fault Detection	Diagnosis
The light won't start up.	Long press the 'Power' button, if it does not display "NANLITE" Logo, connect to a power source and try again.
The display is on but no light output.	Please check if the intensity is set to zero or if the light is in storm/welding mode.
The light is flickering.	(1) Please ensure the unit is not being operated in extreme temperatures. (2) Ensure the fixture is not in EFFECT mode.
If the failure is not resolved after troubleshooting, please contact place of purchase.	

This manual and all stats within it were produced under controlled conditions, and are accurate at time of print. Any future changes to design/technical data can be found at [www.nanlite.com](http://www.nanlite.com).

Version: V4 2021-01-25

# NANLITE

 +86-754-85751187

 +86-754-85300887

 [service@nanlite.com](mailto:service@nanlite.com)

 Zhanglin,324,Dongli Chenghai Shantou Guangdong China

[www.nanlite.com](http://www.nanlite.com)