

NANLITE

PavoBulb 10C
USER MANUAL

Guangdong NanGuang Photo&Video Systems Co., Ltd



PavoBulb 10C RGBWW LED Bulb

■ Product Diagram

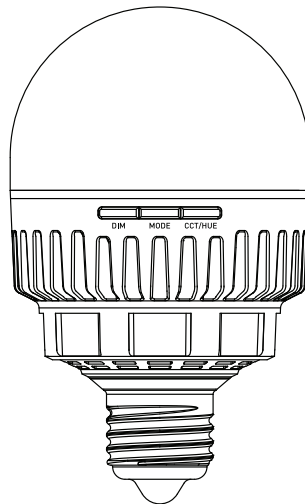

■ Technical Data

Rated Power: 10W

Input Voltage/Current: DC 5V/2.4A

AC 100-240V 50Hz/60Hz

Color Temperature: 2700K-7500K

CRI: Average 95

TLCI: Average 97

Detailed Description

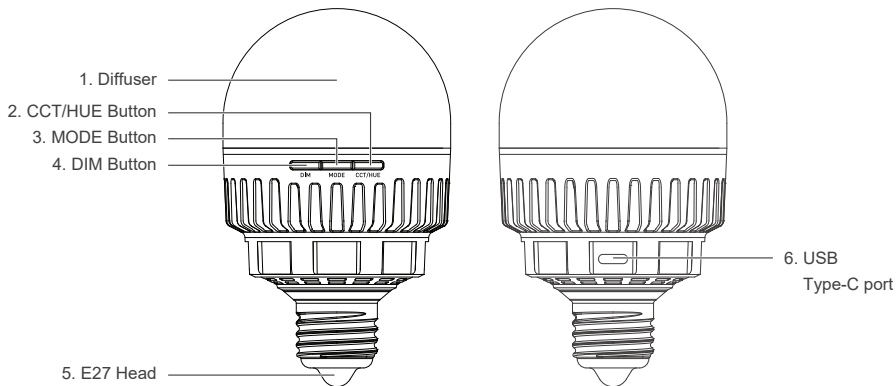

Detailed Description

1. Diffuser: To soften the light.
2. CCT/HUE Button: Short press CCT/HUE button to adjust CCT or HUE by intervals.
3. MODE Button: Short press MODE button to switch modes between CCT and HSI.
4. DIM Button: Short press DIM button to adjust the intensity by intervals.
5. E27 Head: Power the bulb with E27 Edison-base.
6. USB Type-C Port: For power input or firmware updates. And for DMX signal input and output when connected with USB-C to DMX cable splitter. (Note: The USB-C to DMX cable splitter is sold separately.)

Usage

1. Power connection

① Connecting the fixture via a USB cable, then to a USB adapter with output 5V/2.4A or more. (See #1)

(Note: USB adapter is not included)

② Screwing the bulb into E27 Edison-base to power the bulb directly.

Note: Please ensure the power is disconnected before screwing in. (See #2)

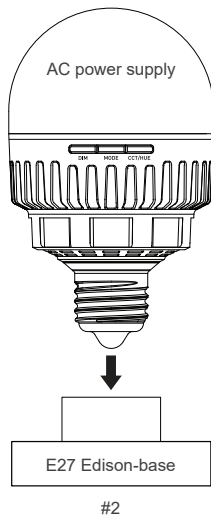
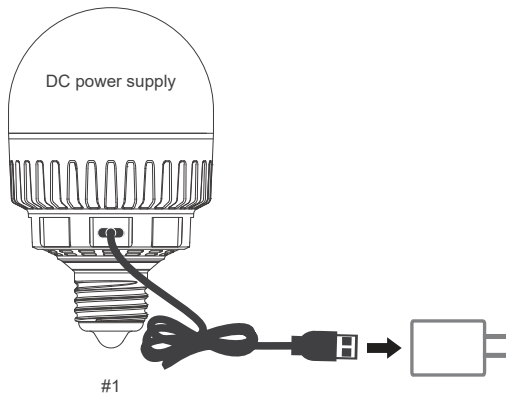

③ Connection with BT-BA-SNP-E27 battery adapter. (See #3)

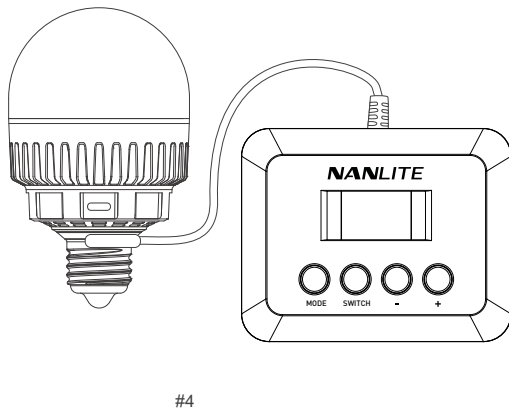
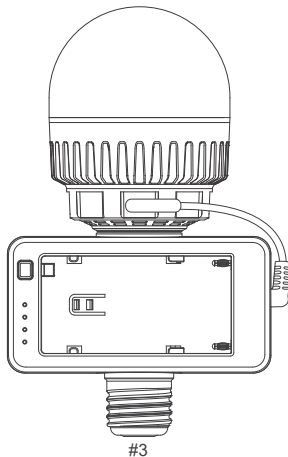

2. Connection between the Light Fixture and WC-USBC-C1 Wire Controller. (See #4)

The fixture can be controlled by the wire controller in CCT mode, HSI mode, EFFECT mode, CHANNEL setting, LANGUAGE, DMX mode, WIRELESS PROTOCOL, BLUETOOTH RESET, FIRMWARE UPDATE and VERSION checking (please refer to wire controller user manual for detailed instructions).

(Note: Wire controller is sold separately.)

Remote Control and Control Method by Wire Controller

- PavoBulb 10C supports DMX, 2.4G and wire controller control, and includes a built-in Bluetooth as well.

▲Address code need to be pre-set for DMX and 2.4G control.

1. Address setting

The address code of the fixture can be set by connecting DMX/RDM console, wire controller or by APP via the transmitter box. (For specific operations, please refer to the relevant manuals.)

2. DMX Remote Control

①Connect the fixture to the DMX/RDM console with a DMX adapter cable.

- The connection between the fixture and DMX adapter cable is as follows:



- The connection between light fixtures, or light fixture and DMX/RDM console should use DMX adapter cable. (DMX adapter cable is not included.)

XLR plug/socket and the wire should be connected as shown above.

- Pin1, Pin2, Pin3 for connecting DMX signal. Pin4, Pin5 has no connection.

▲NOTE: When connecting DMX, make sure the internal pin is not in contact with the inner case. The fixture can match the DMX512 (1990) control signal.

②DMX Terminator

In DMX control mode, the DMX output of the last fixture should be connected with a DMX terminator (Not included). This prevents interference caused by DMX signals in the transmitting process.

The terminator is connected with a 120Ω(OHM) resistor across Pin 2 and Pin 3. (As shown below)

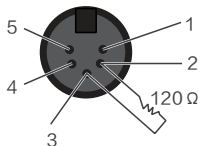

DMX Terminator Connection
Connect a 120Ω(OHM) resistor
across Pin 2 and Pin 3 in an XLR
plug and insert into the DMX OUT
socket on the last unit.

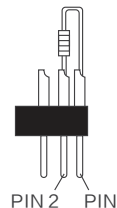

③Set the channel of the fixture.

④Refer to the DMX reference guide and control the light via DMX/RDM console. (For detailed operation please refer to the DMX/RDM console operation manual.)

Note: DMX reference guide "PavoBulb_10C_DMX_REFERENCE_GUIDE_EN" is downloadable from www.nanlite.com.



Please scan the QR code to check or download the latest DMX reference guide.

3. 2.4G Remote Control

- Set the address of the 2.4G remote controller to be consistent with the light fixture, enabling the fixture to be remotely controlled by 2.4G remote controller or by APP via the transmitter box.

Note: ①2.4G remote controller and transmitter box are sold separately.

②The fixture supports the 2.4G wireless protocol V1.0 and V2.0. Please set fixture to V2.0 while using WS-RC-C1 or WS-RC-C2 remote controller. Please set fixture to V1.0 while using other remote controllers.

- The following is how to modify the wireless control protocol using the wire controller.

(Note: The wire controller is sold separately.)

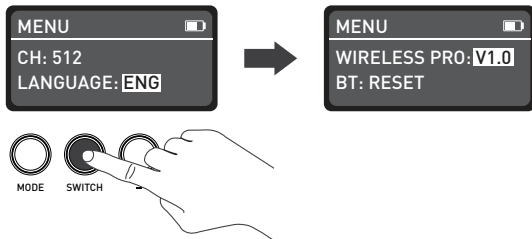

Press SWITCH button to WIRELESS PROTOCOL.

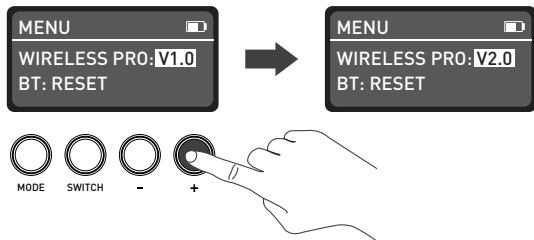

Press + - to select V1.0 or V2.0.

Operating Instructions

1. The Bulb will light up automatically once powered.
2. DIM Button: Short press DIM button to adjust brightness by intervals from 0%, 20%, 40%, 60%, 80%, 100%.
When it reaches 100%, press the DIM button, the brightness will reset to 0%.
3. MODE Button: Short press MODE button to switch modes between CCT and HSI.
4. CCT/HUE Button: Short press CCT/HUE button to adjust CCT or HUE by intervals.
When reaching to maximum value, it will return to minimum value when pressing the button again. (When the HUE was adjusted to 360, press the button again it will return to 30.)
CCT: 2700K, 3200K, 4300K, 5600K, 6500K, 7500K.
HUE: 0, 30, 60, 90, 120, 150, 180, 210, 240, 270, 300, 330, 360.
5. Bluetooth Reset: Long press the three buttons at the same time until the bulb flashes in blue for 3 seconds, that means the reset is completed.

6. Firmware Update: ①When the PavoBulb 10C is powered by the E27 Magnetic Mount, long press MODE button after inserting the USB flash drive with new firmware, the bulb will flash in blue. Then long press the DIM button and CCT/HUE button at the same time to start the firmware upgrade. After the upgrade is completed, the bulb will flash in green before entering the normal function state. If the upgrade fails, the bulb will flash in red for 3 seconds and then return to the normal function state. ②The PavoBulb 10C can be upgraded by the wire controller. For the detailed operations, please refer to the user manual of the wire controller.
7. When not using the fixture, it will turn off automatically once disconnected from a power supply.

Notice

1. When the fixture is turned on, do not look directly at the emitter.
2. Please do not leave flammable or explosive articles within 0.5m of the fixture.
3. Avoid placing lamps near flammable and volatile substances, such as alcohol or gasoline.
4. When cleaning the fixture, please use soft cloth with neutral detergent to wipe off dirt. Please do not use abrasives or strong detergent.
5. During use, do not cover, restrict or obstruct ventilation holes, so as not to affect the heat dissipation and cause damage to the fixture. Please take care when using the lamp for long periods, as the surface temperature can be high.
6. Please do not disassemble the fixture or attempt to carry out repairs. Any required maintenance should be carried out by suitably qualified professionals, operating in strict compliance with the instructions described in this manual.



Safety Precautions

1. Please open the package to check for possible damage. If damaged, do not use. Please contact your dealer or the manufacturer as soon as possible.
2. Please use the standard E27 lamp holder with safety certification.
3. Before installation, please make sure the power supply voltage is correct and compatible with that specified on fixture.
4. Please turn off the power when fixture is not in use or being cleaned.
5. Please operate the fixture safely. Keep fixture away from children.







The light won't start up.

Fault Detection	Diagnosis
The light won't boot up properly	<ol style="list-style-type: none"> 1. Please ensure the standard E27 lamp holder being used. 2. Please ensure the power voltage value as indicated.



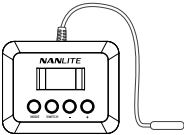

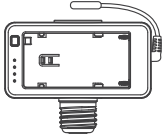
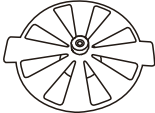

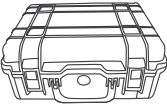
What's in the box? Please kindly check.

PavoBulb 10C×1	USB Type-C Cable×1	User Manual×1
		

PavoBulb 10C 4KIT

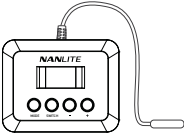
<p>PavoBulb 10C×4</p>	<p>AS-MBA-E27 Magnetic Mount×2</p>	<p>WC-USBC-C1 Wire Controller×2</p>
		
<p>USB Type-C Cable×2</p>	<p>AC Cable×1</p>	<p>BT-BA-SNP-E27 Battery Adapter with E27 Head×2</p>
		
<p>AS-BSC Bouncer with Suction Cup for Light Bulb×4</p>	<p>User Manual×1</p>	<p>Hard Case×1</p>
		

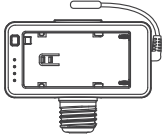
PavoBulb 10C 12KIT

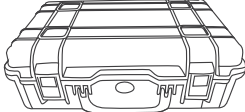
<p>PavoBulb 10C×12</p>	<p>AS-MBA-E27 Magnetic Mount×6</p>	<p>WC-USBC-C1 Wire Controller×6</p>
		
<p>USB Type-C Cable×3</p>	<p>AC Cable×3</p>	<p>BT-BA-SNP-E27 Battery Adapter with E27 Head×6</p>
		
<p>AS-BSC Bouncer with Suction Cup for Light Bulb×12</p>	<p>User Manual×1</p>	<p>Hard Case×1</p>
		

This manual and all stats within it were produced under controlled conditions, and are accurate at time of print. Any future changes to design/technical data can be found at www.nanlite.com.

Version: V2 2022-01-25

NANLITE

 +86-754-85751187

 +86-754-85300887

 service@nanlite.com

 Zhanglin,324,Dongli Chenghai Shantou Guangdong China

www.nanlite.com