

PHILIPS

Ultinon

LED

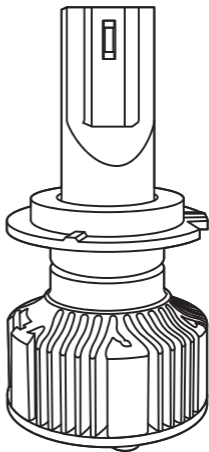

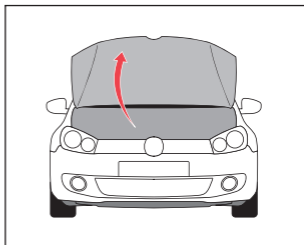
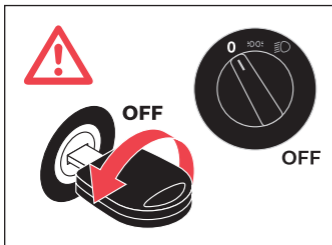
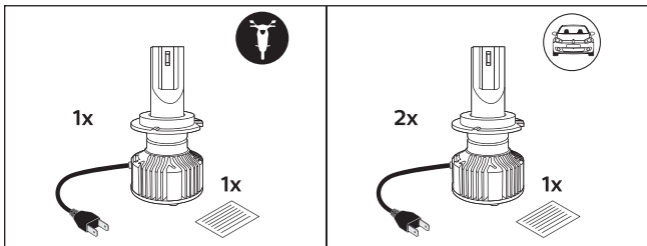

H7/H4 A1

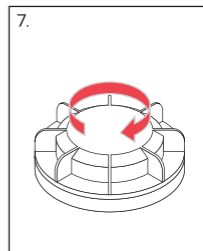
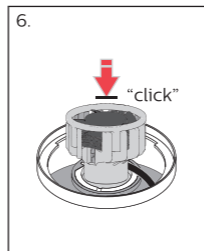
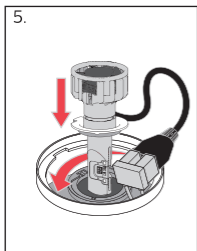
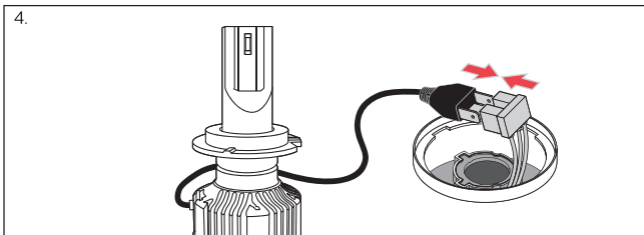
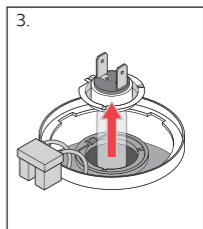
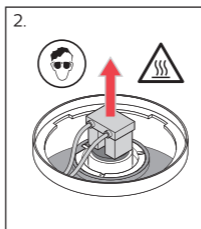
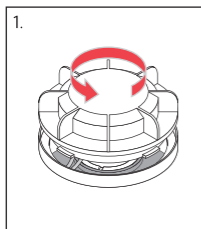

H7/H4 A2

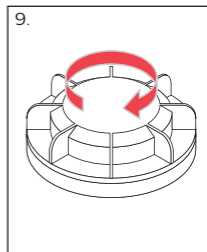
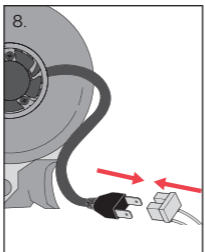
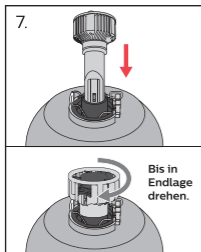
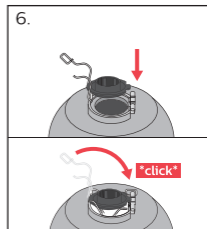
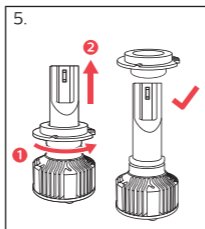
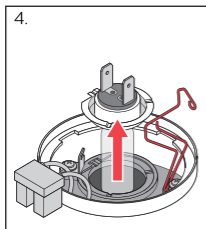
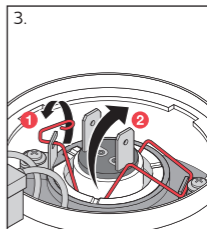
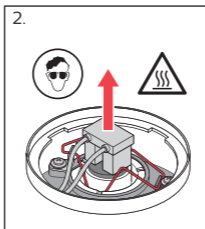
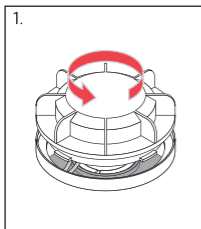

H1/H3 A1

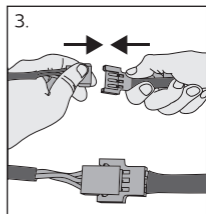
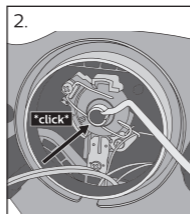
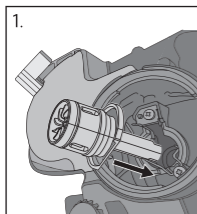

H1/H3 A2

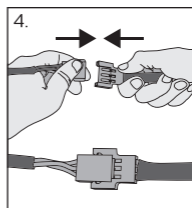
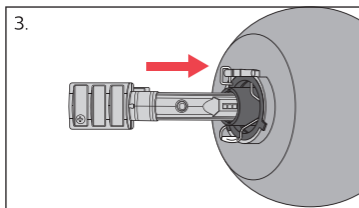
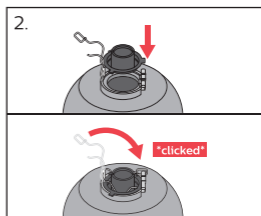
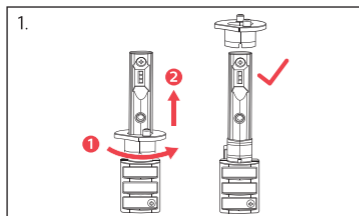

HB3/HB4

1.

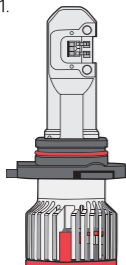

HB3

Accessory:

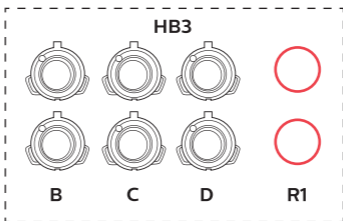

HB3

HB4 rings



B

C

D

R1

R2

HB4

2.

R1



R2

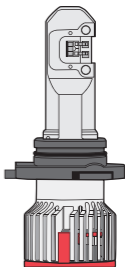
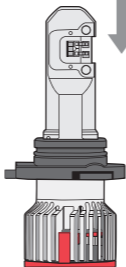
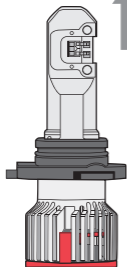

HB3 (Default A)

HB4

2.

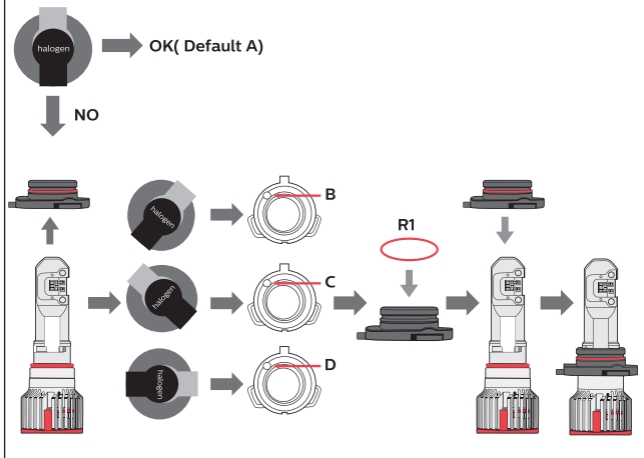

HB3/HB4

3.

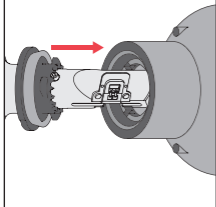

4.

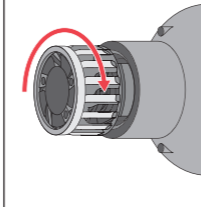

5.

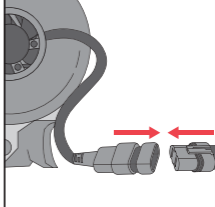

1.



Accessory:



B

2.



OK (Default A)

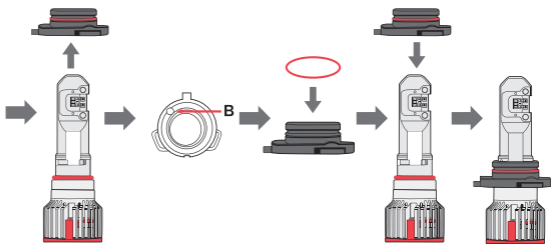

3.

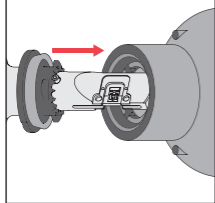

4.

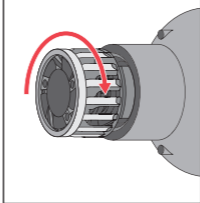

5.

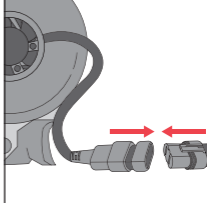

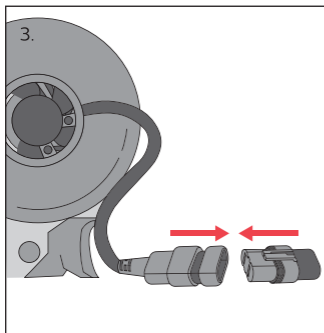
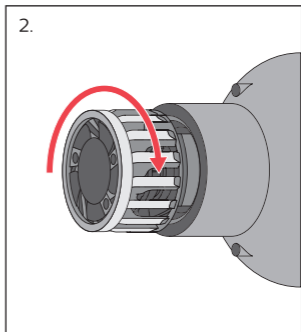
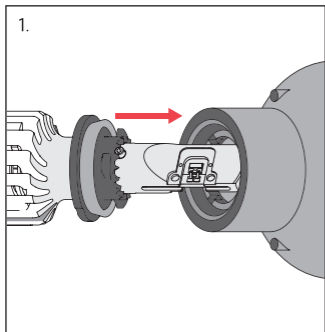

Ultinon Motion is the warrantor of this product.
Philips and the Philips Shield Emblem are registered trademarks of Koninklijke Philips N.V. and are used under license.
2024-2025 © Ultinon Motion Holding B.V. All rights reserved.

ATTENTION:

1.

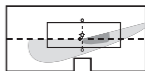
**TEST**

2a

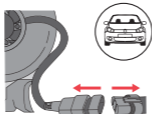

2b

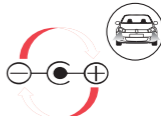

2c

3.

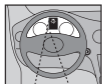

4.

**CANbus**