



INSTALLATION GUIDE



HONDA CIVIC 1.5T (2022+)
HIGH VOLUME INTAKE

PRL INSTALLATION OVERVIEW

PRODUCT: PRL-HC11-INT-HVI PRL MOTORSPORTS HIGH VOLUME INTAKE

FITMENT: 2022+ Honda Civic 1.5L Turbo

INSTALLATION TIME: Approximately 30 - 45 minutes

NOTE: THIS ITEM DOES NOT REQUIRE AN ECU RE-CALIBRATION.

Please check that all components that are listed in the parts list have been supplied to you, and are correct. If you require any assistance or are missing components please email: support@prlmotorsports.com. Please verify with a customer service representative before installation or returning the product.

PRODUCT DISCLAIMER:

United States 48 State Compliant:

California/New York Residents please see Prop 65.

This is a Race Only product that is to be used solely for competition, it cannot be used on vehicles that are operated on public streets, roads or highways. Its use is limited to closed-course and open-course racing that is formally sanctioned by a recognized racing organization. Any other use including recreational use could be in violation of local, state and federal laws.

PRL Motorsports is not responsible for any vehicle damage or personal injury that may occur due to an installation error, product misuse, or removal of PRL Motorsports products. PRL Motorsports highly suggests that a trained professional conduct the installation on all products. PRL Motorsports is not responsible for damaged products due to incorrect installation.

REQUIRED TOOLS:

Ratchet

Extension (3" & 12" Length)

10mm Socket

Phillips Head Screw Driver

Flat Head Screw Driver

Magnetic Pickup Tool (Recommended)

Clip Removal Tool (Optional)

Pliers (Optional)



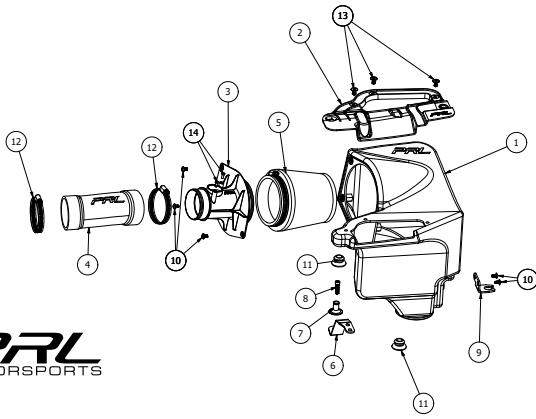

COMPONENT LIST

#	PART #	QTY	DESCRIPTION
1	RAW-HC11-INT-HVI-ROTOBOX	1	2022+ Civic 1.5T High Volume Airbox
2	RAW-HC11-INT-HVI-INLET	1	2022+ Civic 1.5T Inlet Duct
3	RAW-HC11-INT-HVI-MAF	1	2022+ Civic 1.5T High Volume MAF Housing
4	SIL-HC11-INT-HVI-HOSE	1	2022+ Civic 1.5T High Volume Silicone Intake Hose
5	PRL-AF-4258	1	PRL 4" Inlet Air Filter Assembly
6	RAW-HC11-INT-HVI-BKT-A-ASS	1	2022+ Civic 1.5T High Volume Bracket A Assembly
7	PRL-POST-MOUNT	1	Airbox Mounting Post
8	BOLT-M6x1x30-SHCS	1	M6x1x30mm Socket Head Cap Screw
9	RAW-HC11-INT-HVI-BKT-B	1	2022+ Civic 1.5T High Volume Bracket B
10	MCM-90909A722	5	M5 x 0.8 x 10mm Flanged Button Head Cap Screw
11	PRL-RABG	1	PRL Rubber Grommet
12	IFE-60-80-12	2	IFE 60-80-12 Hose Clamp
13	DISCO-14996	3	7mm Plastic Push-Through Rivet Clips
14	MCM-91292A116	2	M4x10mm Socket Head Cap Screw

Before Beginning Your Installation:

1. Turn off the ignition. Loosen battery terminal and disconnect the negative battery terminal cable. Allow the vehicle to sit for a minimum of 5 minutes to drain any remaining charge from the charging system.

NOTE: Disconnection of the negative battery cable erases pre-programmed electronic memory. We recommend saving any memory settings before disconnecting the negative terminal. Some radios will require an anti-theft code to be entered after the negative battery cable is reconnected.



Preparing Your High Volume Intake

2. Before beginning any OEM component removal, please reference the parts list and ensure all components are enclosed. If something is missing, please contact PRL Customer Support.

3. The factory air box will need to be removed to install the High Volume Intake. This design utilizes the hood style scoop duct that directs the coolest air into your intake.

4. You will need to remove the factory air duct that is mounted into the top of the engine bay. Remove the (2) factory 10mm bolts.



5. You will also need to remove the (1) plastic tab that affixes the factory air duct. You can use a flathead screwdriver to remove. This will not be re-used.

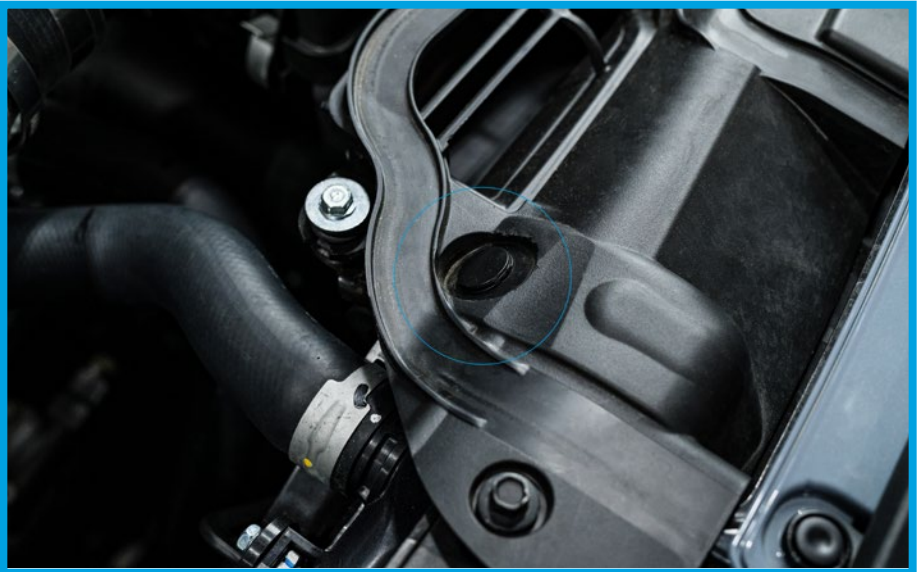

6. Use a 3" extension to remove the (2) 10mm bolts from the bracket on the front of the airbox. You will then remove the (2) 10mm bolts to remove the bracket that holds the factory duct to the core support.



7. OPTIONAL: If you need more clearance to reach the (1) 10mm bolt on the side of the airbox, you can remove the resonator from the factory hose. Simply wiggle it back and forth till it comes free from the hose.



8. If you have not done so, disconnect the MAF sensor harness from the factory MAF sensor. Simply lay the harness out of the way for now. You will take the MAF sensor out of the factory MAF in a later step.



9. Use a 12" extension remove the (1) 10mm bolt on the right side of the airbox. We advise using a magnetic socket/magnetic pick so to not drop the bolt into the engine bay. This will allow the factory air box to be removed.

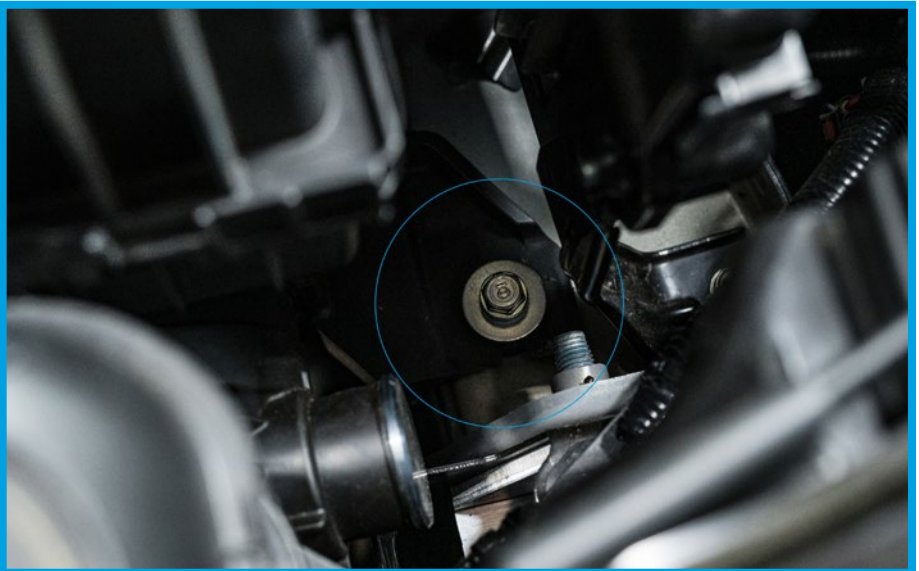

10. While gently wiggling the factory air box side to side you will feel it come free from the factory post mount that is set into the engine bay to secure the airbox into place. Be sure to not use too much force, you could bend this post.



11. Place the Airbox Mounting post in the bracket, with the (1) M6x25mm bolt. Install the provided Mounting Bracket A to the core support with (2) factory 10mm bolts.

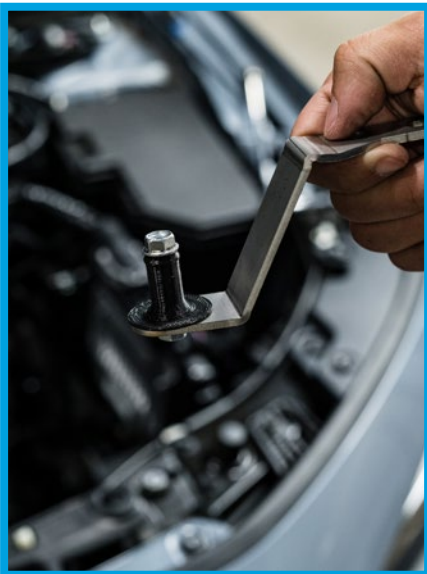

12. Install Mounting Bracket B to the side of the airbox with (2) of the provided 10mm screws. Seat the rubber grommet from the factory airbox into the bracket.

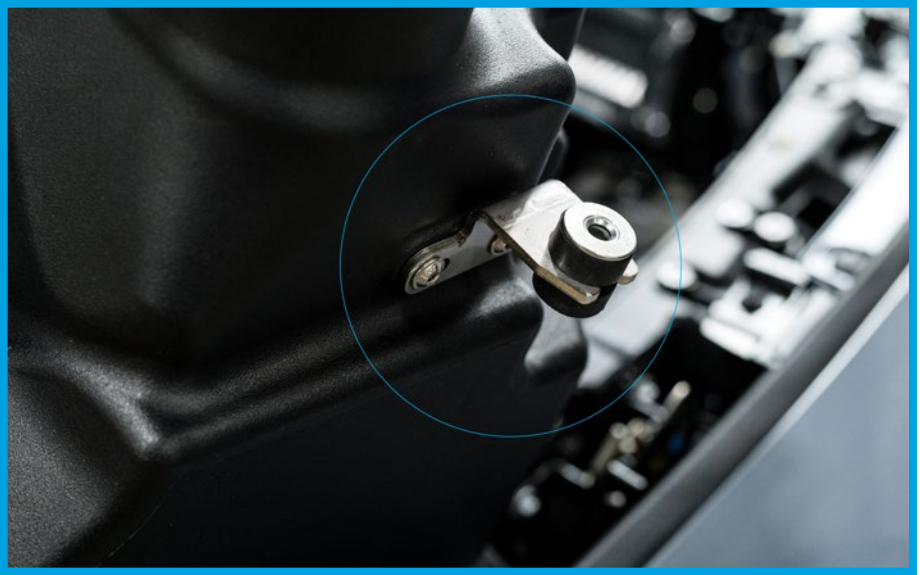

13. Seat the PRL Rubber grommet in the underside of the PRL High Volume airbox. Use light force to pop it into place. This affixes to the mounting post.



14. Place the PRL HVI Airbox into the engine bay, seating it on factory and PRL mounting post. Tighten the (1) factory 10mm bolt on the right side of the airbox.



15. Affix the PRL Inlet Duct to the PRL High Volume airbox. Attach with the (3) plastic push rivets. Using the (2) factory 10mm bolts, attach the duct to the core support.



16. Attach the PRL 4" air filter onto the PRL High Volume MAF housing. Use the worm gear clamp, tightening firmly. Align it on the side of the airbox.



17. Using the (3) provided 10mm screws attach the MAF housing to the PRL High Volume airbox. Do not over-tighten, as you can crack the rotomold material.

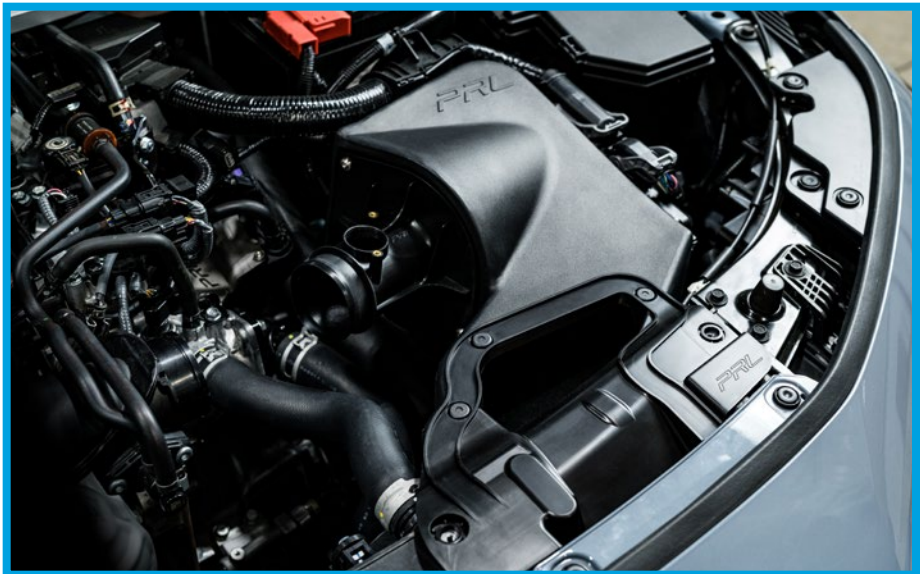

18. Place the Silicone Intake Hose and (2) worm gear clamps onto the MAF housing and the factory inlet. Adjust to where the PRL logo is facing upwards.



19. Once the silicone is adjusted properly. Tight to the (2) worm gear clamps. They should be snug, but do not overtighten to where the silicone is pinched.



20. Remove the factory MAF sensor from the factory airbox. These (2) factory screws will not be re-used. Insert the (2) PRL button cap screws into the PRL MAF housing and tighten. Do not overtighten as you can strip the MAF housing.

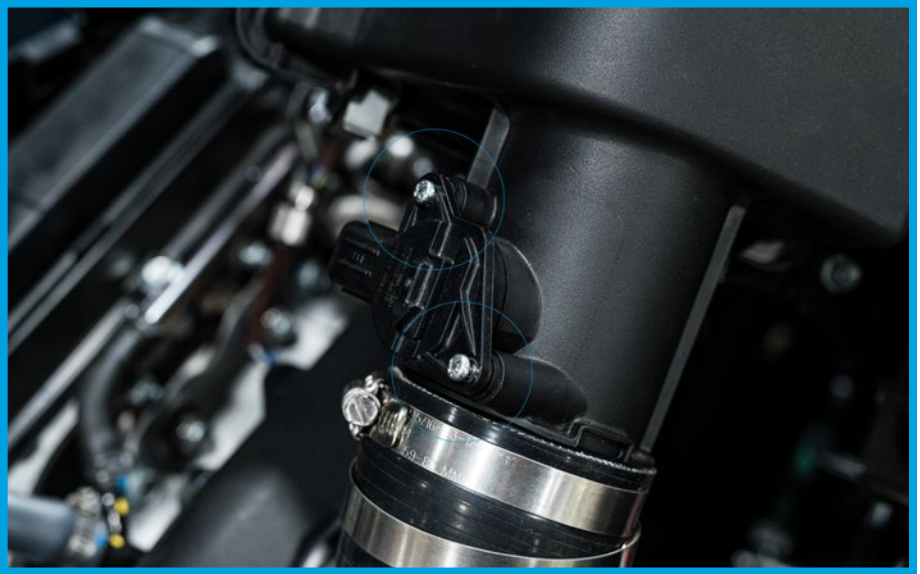

21. Once the MAF sensor is in place, re-attach the MAF harness to it. Check all other connections to ensure everything is tight and in place.

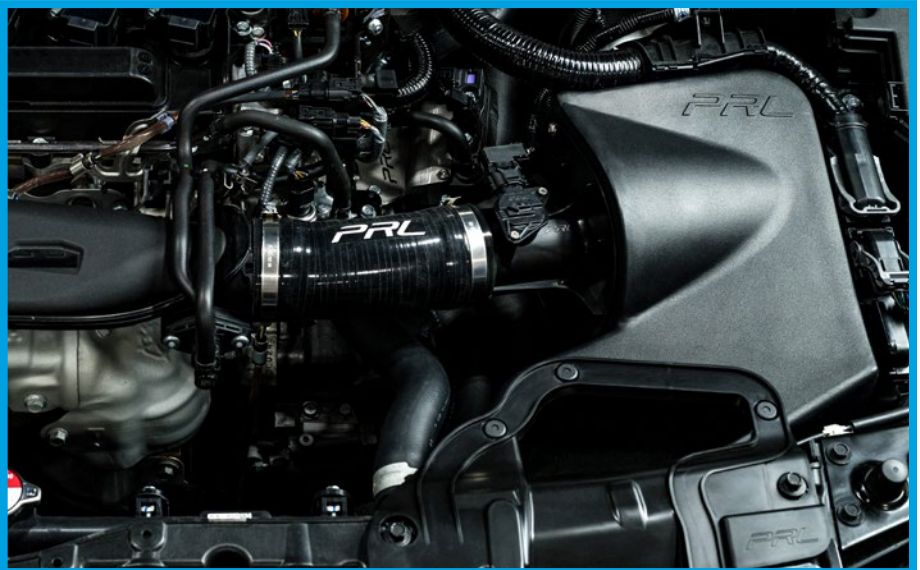

Road Testing Your PRL High Volume Intake

1. Start the vehicle with the transmission in neutral and the emergency brake engaged. Assess to make sure of any possible issue(s) and then make any subsequent adjustments as they are needed.
2. Test drive the vehicle to ensure everything is in working order.
3. If after the road testing, everything is good to go, enjoy your PRL High Volume Intake! Thank you for being a part of the #PRLARMY.

If you have any questions/concerns please reach out to us at:
support@PRLMotorsports.com

Please provide a full description of your issue, ideally with any pertinent images or video clips that can help our team address the issue.

Please note: All support tickets are addressed during business hours and in order of received.

As stated at the beginning of this guide, the PRL High Volume Intake has been specifically designed to be 100% compatible with the factory ECU calibration. No tuning is required to benefit from the advertised gains and performance.

Required Maintenance

PRL Motorsports thoroughly recommends visually inspecting the air filter screen inside the HVI at every oil change. It is required to clean the air filter element whenever the screen is no longer visible or at a 30,000 mile interval. When used in a higher dust/arid climate or varied terrain environments, the air filter will require cleaning more often. To clean and re-oil, our #2801 Filter Cleaning & Recharge kits can be purchased direct on our website, or via an authorized PRL Motorsports dealer.

Filter Recharging Guide:

- 1. Pre-Cleaning:** Tap the filter or use canned air/compressor to remove any excess debris from the filter. Be careful to not damage the filter.
- 2. Apply Cleaner:** Spray the filter with the special cleaning solution provided in the kit and allow the solution to soak in for at least 15 minutes.
- 3. Rinsing:** Rinse the filter with warm water, clean side to dirty side to flush the dirt and debris outwards from the filter.
- 4. Drying:** Allow the filter to dry naturally. Try to avoid heat to prohibit any shrinkage that could occur in the cotton present in the filter.
- 5. Oil Application:** Re-oil the filter using the filter oil that is supplied in the kit. It is recommended to use a single spray per 2" of filter media. Do not over oil.



1400 RANDALL COURT - UNIT 104
EXPORT, PENNSYLVANIA 15632

www.PRLMotorsports.com

Follow Us!
PRLMotorsports

