

32" RAIDER 155Hz 4K ULTRA GAMING

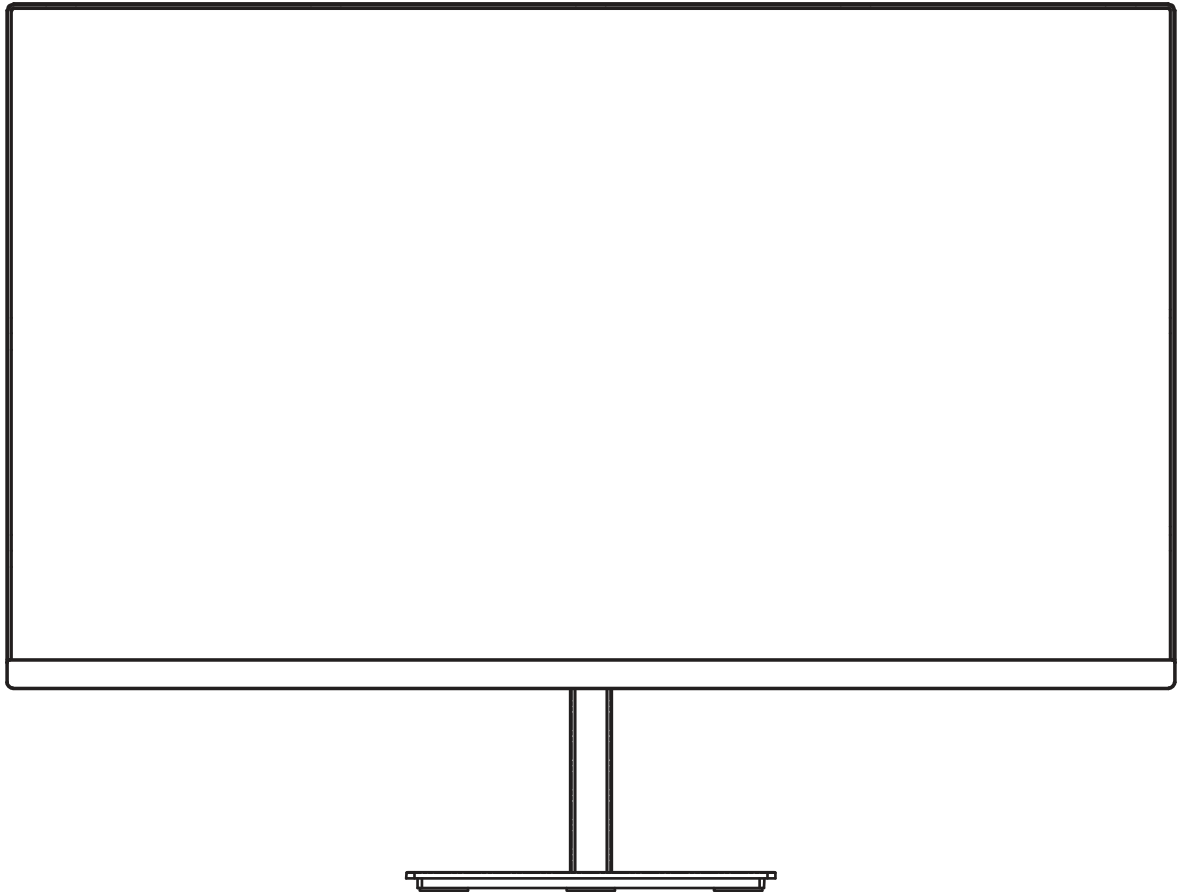

Please read this manual thoroughly before use, and keep it handy for future reference

SAFETY INFORMATION



- Read these instructions - All the safety and operating instructions should be read before this product is operated.
- Keep these instructions - The safety and operating instructions should be retained for future reference.
- Heed all warnings - All warnings on the appliance and in the operating instructions should be adhered to.
- Follow all instructions - All operating and usage instructions should be followed.
- Do not use this equipment near water, or in humid environments – The appliance should not be used near water or moisture e.g. in a wet basement or near a swimming pool.
- Clean only with a dry cloth. Do not use solvents or petroleum based fluids.
- Do not block any ventilation openings.
- Do not install near any heat sources such as radiators, stoves or other apparatus (including amplifiers) that produce heat.
- Do not tamper with the supplied plug. This plug is a BS1363 standard plug.
- Protect the power cord from being walked on or trapped, particularly at the plug and at the point where it exits from the appliance.
- Only use attachments/accessories specified by the manufacturer.
- Use only with a cart, stand, tripod, bracket or table specified by the manufacturer or sold with the apparatus. When a cart or stand is used, use caution when moving it to avoid any injuries or damage from it tipping over.
- Unplug the apparatus during lightning storms or when unused for long periods of time.
- Refer all servicing to qualified personnel. Servicing is required when the apparatus has been damaged in any way, such as if the power supply cord or plug is damaged, liquid has been spilled or objects have fallen into the apparatus or it has been exposed to rain or moisture, it does not operate normally or has been dropped.
- Please keep the unit in a well-ventilated environment.
- The monitor should only be connected to a mains power supply as rated on the back of the equipment.
- To prevent overload, do not share the same power supply socket with too many other electronic components.
- Do not place any connecting wires where they may be stepped on or tripped over.
- Do not place heavy items on the cable as this may cause damage.
- When removing from a socket hold by the plug and not the wires.
- Disconnect the power immediately and seek professional help if the plug or cable is damaged, liquid has spilt onto the set, if accidentally exposed to water or moisture, if anything accidentally penetrates the ventilation slots or if the set does not work normally.
- Do not remove the safety covers. There are no user serviceable parts inside.

Trying to service the unit yourself is dangerous and may invalidate the product's warranty. Only qualified personnel should service this apparatus.

- Do not block ventilation slots on the back cover. The monitor can be placed in a cabinet but ensure at least 5cm (2") clearance all around. Do not tap or shake the screen, this may damage internal components.
- **WARNING:** To reduce the risk of fire or electric shock, do not expose this apparatus to rain or moisture. The apparatus shall not be exposed to dripping or splashing and objects filled with liquids, such as vases, shall not be placed on the apparatus.
- **WARNING:** The wall plug socket is used as a disconnection device and should remain readily accessible.
- **WARNING:** The batteries shall not be exposed to excessive heat such as direct sunlight or fire.



AT FULL VOLUME, PROLONGED LISTENING MAY DAMAGE THE USER'S HEARING.

 <p>This warning sign is to warn of dangerous voltage inside the product.</p>	<p>CAUTION RISK OF ELECTRIC SHOCK DO NOT OPEN</p> <p>CAUTION: To reduce the risk of electric shock, DO NOT remove the cover (or back). No user serviceable parts inside. Refer servicing to qualified service personnel.</p>	 <p>This warning sign is to alert you of important instructions accompanying the product.</p>
---	---	---

WHAT'S INCLUDED



User manual

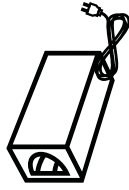

Power supply



Power cable



DP cable

CONNECTIONS AVAILABLE ON THE MONITOR

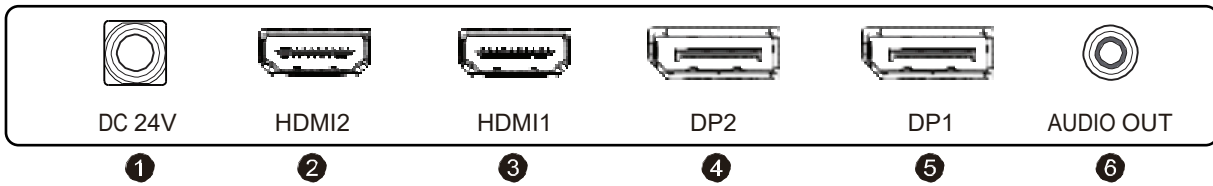

- ① Power
- ② HDMI2
- ③ HDMI1
- ④ DP2
- ⑤ DP1
- ⑥ AUDIO OUT

GETTING STARTED

MONITOR CONTROLS

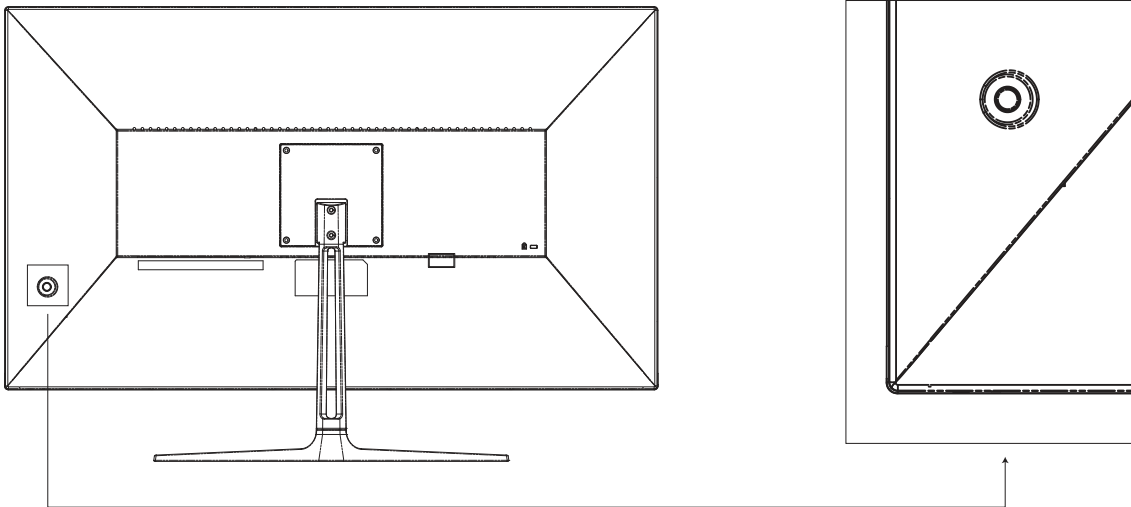

1. POWER
Press and hold for 3 seconds to power off, press once to pop up the menu.
2. UP
Change the value on selected menu/Switch a menu on OSD.
3. DOWN
Change the value on selected menu/ Switch a menu on OSD.
4. LEFT
Change the value on selected menu/ Switch a menu on OSD.
5. RIGHT
Change the value on selected menu/ Switch a menu on OSD.
6. Lamp switch
Click to change the light color, and press and hold to turn off the light.

INITIAL SETUP

Connect the monitor to a power outlet.

1. Press the power button on the monitor or to turn it on (The indicator will be blue).
2. Connect the relevant cable to the corresponding input on the monitor. The source will be automatically detected.
3. To change between inputs, press the "Source" button to enter the source menu. Use the "▲" and "▼" buttons to choose the input source between Auto Select, DP1, DP2 and HDMI1, HDMI2.

DP1 (1.4)

DP2 (1.4)

HDMI1 (2.1)

HDMI2 (2.0)

OSD MENU

Bri/Contrast

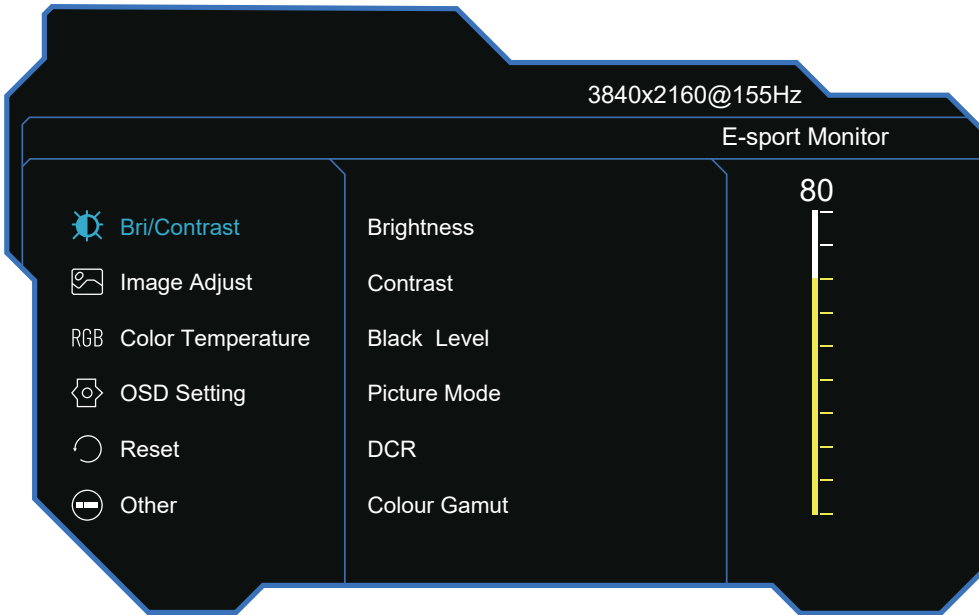

Brightness: Change the display brightness value from 0 to 100.

Contrast: Adjust the display contrast value from 0 to 100.

Black Level: Change the display black level value from 0 to 100.

Picture Mode: Change the picture mode to:Standad, Eye Protect,Game,FPS,Movie,RTS.

DCR: Turn the Dynamic Contrast Ratio feature On or Off.

Colour Gamut: Change the colour gamut mode to:Off,sRGB,DCI-P3.

Image Adjust

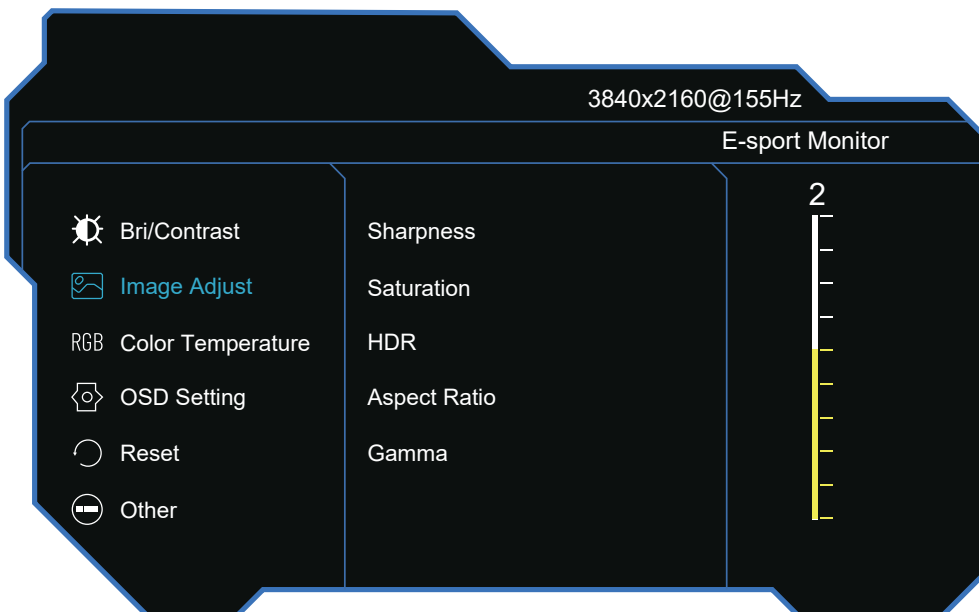

Sharpness: Change the display sharpness value from 0 to 4.

Saturation: Change the saturation sharpness value from 0 to 100.

HDR: Change the display hdr value from 0 to 100.

Aspect Ratio: Change the aspect ratio mode to:Full,4:3,16:9.

Gamma: Change the gamma mode to:Off,1.8,2.0,2.2,2.4,2.6.

Color Temperature



Color Temperature: Change the color temperature mode to:Cool,Normal,Warm,User.

OSD Setting

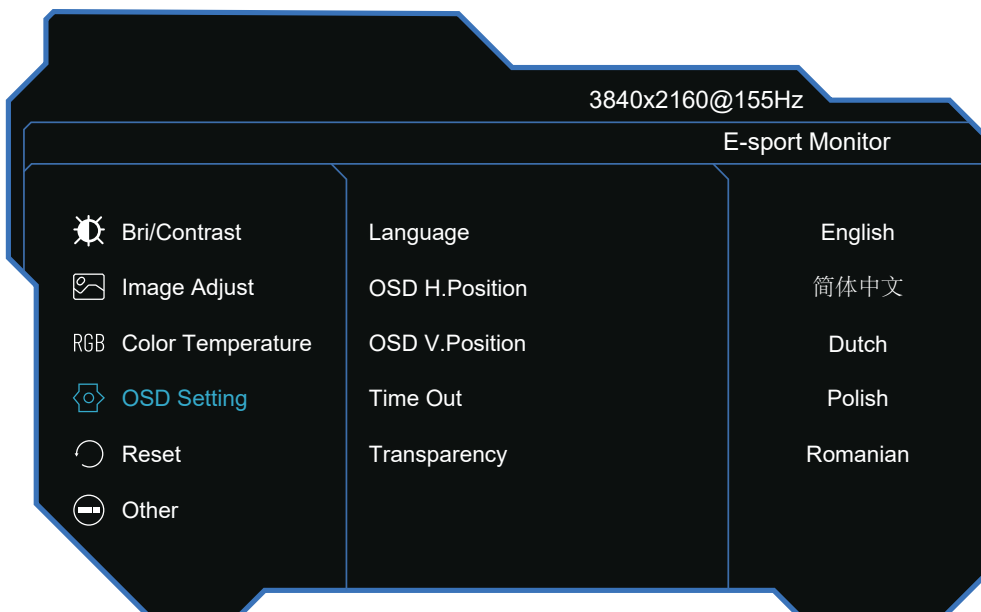

Language: Change the OSD Menu display language.

OSD H.Position: Change the horizontal position of the OSD Menu.

OSD V.Position: Change the vertical position of the OSD Menu.

Timer Out: Change how long the OSD Menu is on before it automatically exits.

Transparency: Change the transparency value of the OSD Menu from 0 to 100.

Reset



Reset: Restore the original settings.

Flicker Free: Turn the flicker free feature On or Off.

Other

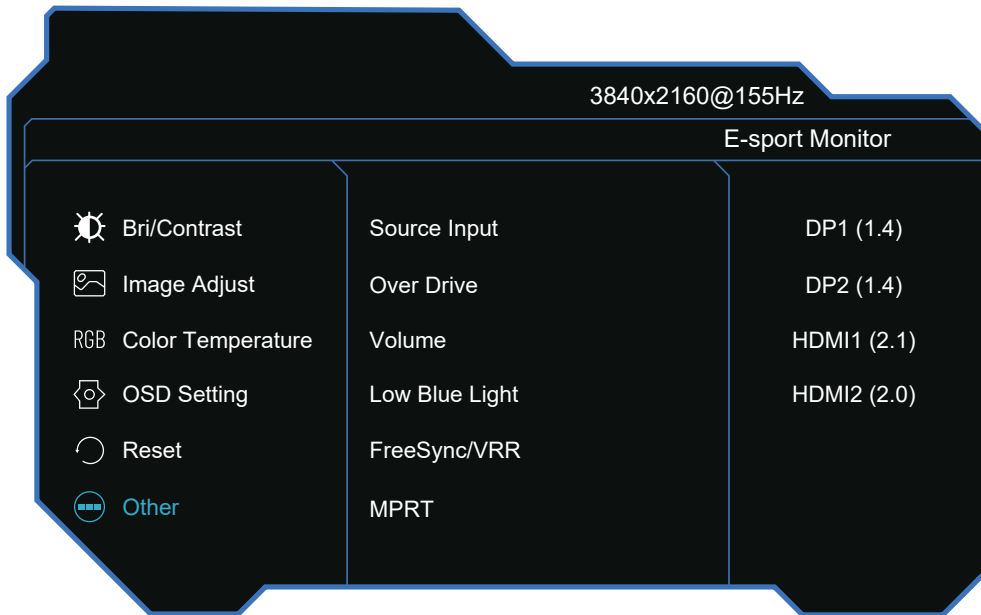

Source Input: Switch the signal input to DP1,DP2,HDMI1,HDMI2,or have the monitor Auto Select the source.

Over Drive: Turn the over drive feature On or Off.

Volume: Change the display volume value from 0 to 100.

Low Blue Light: Change the display low blue light value from 0 to 100.

FreeSync/VRR: Turn the FreeSync/VR feature On or Off.

MPRT: Turn the MPRT feature On or Off.

SPECIFICATION

Model No.:	32" RAIDER 155Hz 4K ULTRA GAMING
Screen Size	32"
Panel Type	LED
Aspect Ratio	16:9
Brightness (Typical.)	400cd/m ²
Contrast Ratio (Typical.)	1000:1
Resolution	3840x2160 @ 155Hz (downwards compatible)
Response Time (Max. with OD)	1ms (OD)
Viewing Angle (Horizontal/Vertical)	178°/178° (CR>10) IPS (ADS)
Color Support	(1.07 B colors (8bit+FRC)
Video Signal	Analog RGB/Digital
Sync. Signal	Separate H/V, Composite, SOG
Connector	HDMIx2+DPx2
Power Consumption	Typical 42W
Stand By Power (DPMS)	<0.5W
Type	DC24V, 4A
Freesync and G-Sync	Supported
HDR	Supported
Over Drive	Supported
Low BBlue Light Mode	Supported
Audio	2x3W