

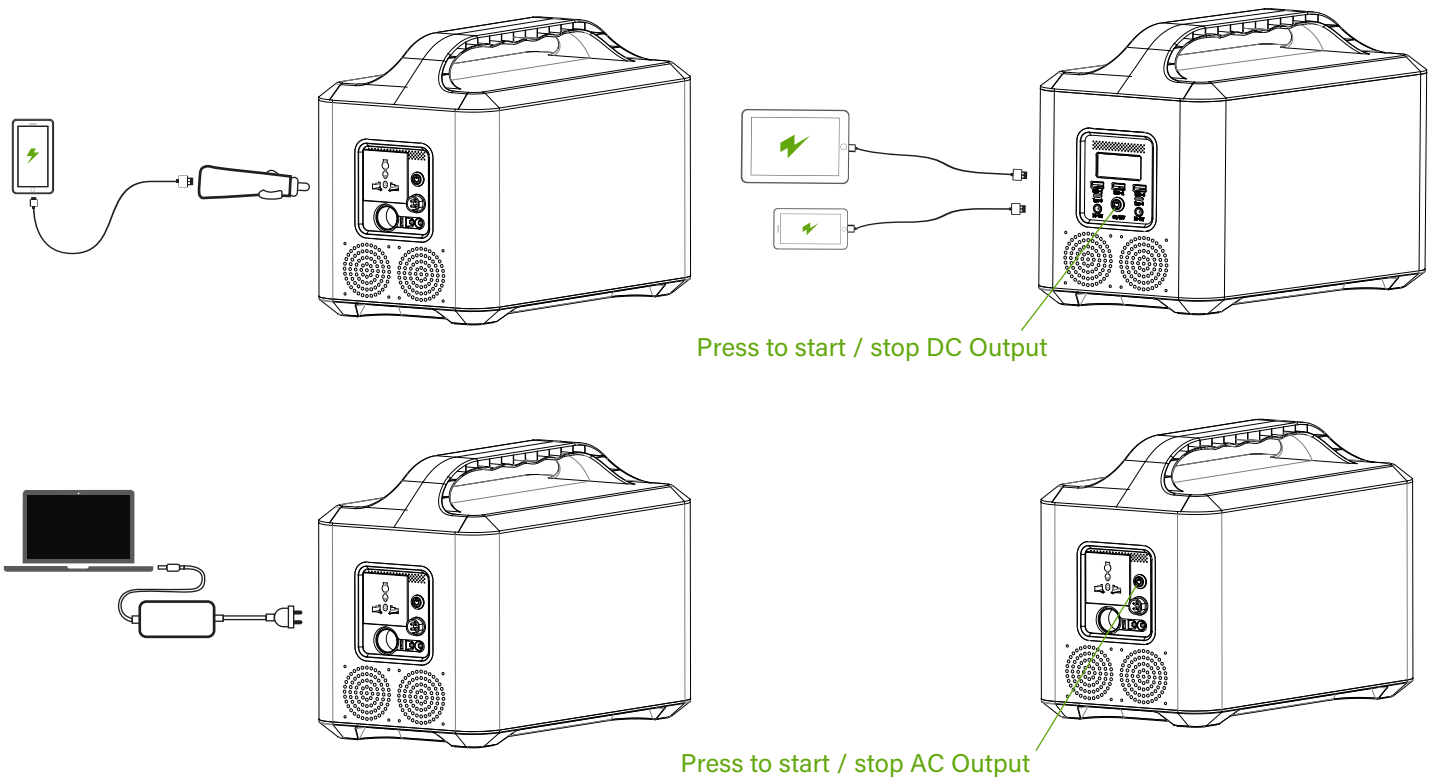

RELi<sup>3</sup>ON<sup>®</sup>

USER MANUAL  
**OUTLAW 10725**  
Power Station & Solar Generator  
(Solar Panel not included)

# DISCHARGING THE OUTLAW 1072S



## DISCHARGE OPERATION

1. Set the AC and/or DC power switches to the on position and plug your devices into the appropriate receptacle(s). Use the provided power strip if more than one AC outlet is required. The backlit LCD screen may shut off to preserve power if there are no active external loads. To activate display, apply an external load.

## CHARGE OPERATION

During standby, the indicator on the AC charger (included accessories) shows that LED1 is red and LED2 is green.

During charging the battery pack LED2 turns red.

When the battery pack is fully charged, LED1 turns red and LED2 turns green. Please promptly disconnect the charge cable upon charge completion.

If the Power Station's total output exceeds 1,150W for more than 10 seconds, the BMS will go into protection mode by opening the circuit to prevent damage to the battery. To recover from protection mode, set the AC and DC switches to the off position and unplug all devices. Then set the AC and DC switches to the on position and plug devices back in. You may need to limit the number of devices used at the same time to prevent the power station from going back into protection mode.

The Power Station does not turn off automatically. Turn off each output by pressing its power button when not in use to preserve power. The edge of the buttons are illuminated by a blue ring when powered on.

## Children should not operate the power station without adult supervision

Care MUST be taken with ring terminals of the quick plug (EC5) when connected to the power station. They are a direct live connection to the battery even when the AC or DC power is off. The quick plug (EC5) terminates in ring terminals but these may be replaced with the appropriate matching connector for any DC appliance with current requirements greater than 10 amps but less than 30 amps.

# CHARGING THE OUTLAW 1072S

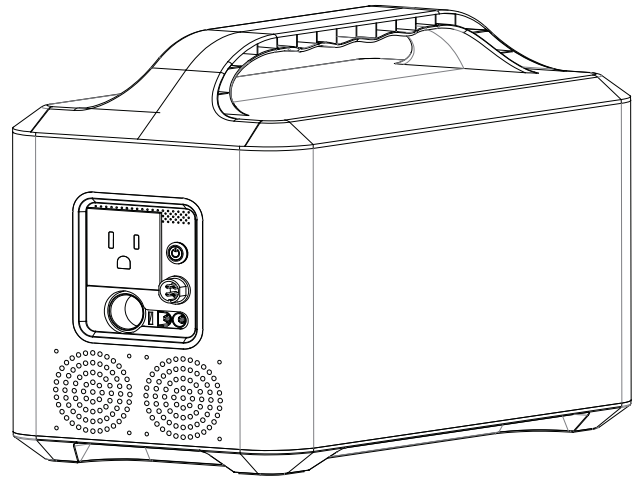
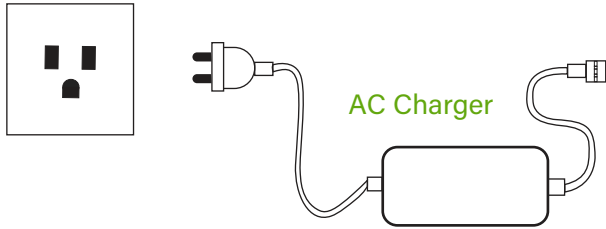

## SOLAR CHARGER

15-25V 160W (Max) Solar Panel

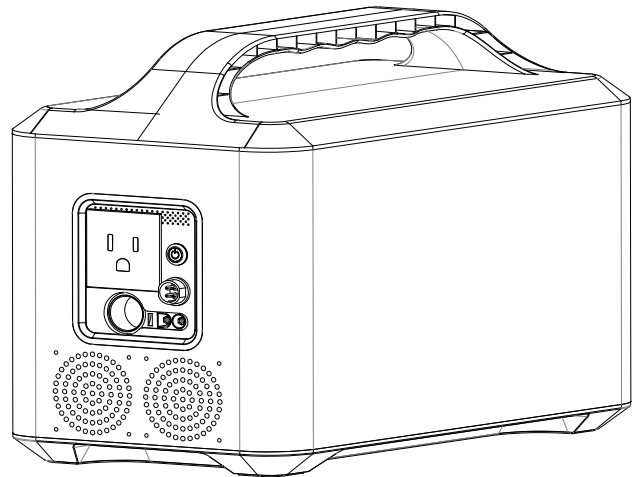
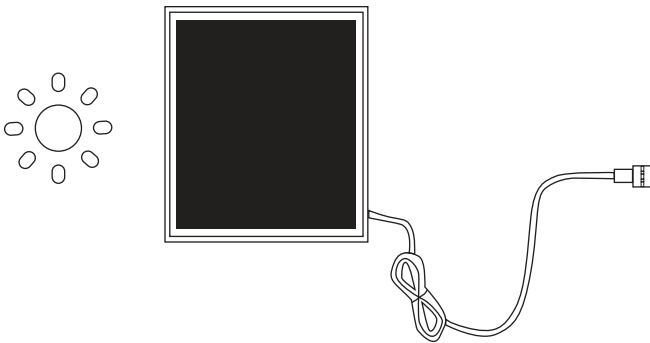

## POWER DISPLAY (VOLTAGE RANGE)



11.0-12.8V



12.8-13.0V

















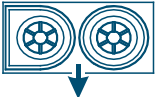







13.0-13.3V











13.3-13.4V

# SPECIFICATIONS

 <p><b>CAPACITY</b> 12.8V72Ah (921.6Wh)</p>	 <p><b>WEIGHT</b> 14.5kg 31.96Lbs</p>	 <p><b>DIMENSIONS</b> L x W x H 368x200x275mm 14.48x7.87x10.82in</p>	 <p><b>DC/PV INPUT</b> DC 14.6V/Max10A Support PV 15~20V</p>	 <p><b>CAR PORT</b> 12V --- 10A</p>	 <p><b>DC PORT</b> 2xDC Port (12V/7A)</p>	 <p><b>DC QUICK PORT</b> 1xDC 30A Quick Charger</p>
 <p><b>TYPE-C OUTPUT</b> Type-C PD DC 5V~6V 3A 6V~9V 2A 9V~12V 1A</p>	 <p><b>USB OUTPUT</b> USB-1/USB-2 DC 5V 2.1A</p>	 <p><b>USB OUTPUT</b> USB-3 DC Quick Charge3.0 5V~6V 3A 6V~9V 2A 9V~12V 1A</p>	 <p><b>AC OUTPUT</b> Region Specific 1x110V~9.09A, 60Hz, -or- 1x220V~4.54A, 50Hz, 1000W max cont., 2000W surge peak</p>	 <p><b>MPPT</b> Support Solar Panel MPPT Charging PV/ 15-25V 160 watts max</p>	 <p><b>PCM</b> Temperature Control, Surge Protection, Short circuit protection</p>	 <p><b>TECHNICAL SUPPORT</b> Lifetime</p>

 <p><b>BATTERY</b> LiFePO4</p>	 <p><b>LCD</b> LCD Display</p>	 <p><b>LIFECYCLES</b> ≥2000</p>	 <p><b>OPERATING TEMPERATURE</b> -20~60°C</p>	 <p><b>RECHARGING TEMPERATURE</b> 0~50°C</p>	 <p><b>MANAGEMENT SYSTEM</b> Under Voltage Protection Over Voltage protection Over Current Protection Short Circuit Protection</p>	 <p><b>WARRANTY</b> 12 Months</p>	 <p><b>CERTIFICATIONS</b> CE,FCC,ROHS UN38.3,MSDS </p>
--	--	---	---	--	---	---	---

# ATTENTION

 <p>Not permitted on aircraft</p>	 <p>Avoid dropping</p>
 <p>To preserve the Outlaw 1072S lifespan discharge and recharge at least once every six months.</p>	 <p>Do not disassemble</p>
 <p>Use original or certified charger and cables</p>	 <p>Do not immerse in water</p>
 <p>Avoid extreme temperatures</p>	 <p>Please dispose of batteries and electronic goods in accordance with local regulations</p>

# PRODUCT DIAGRAM

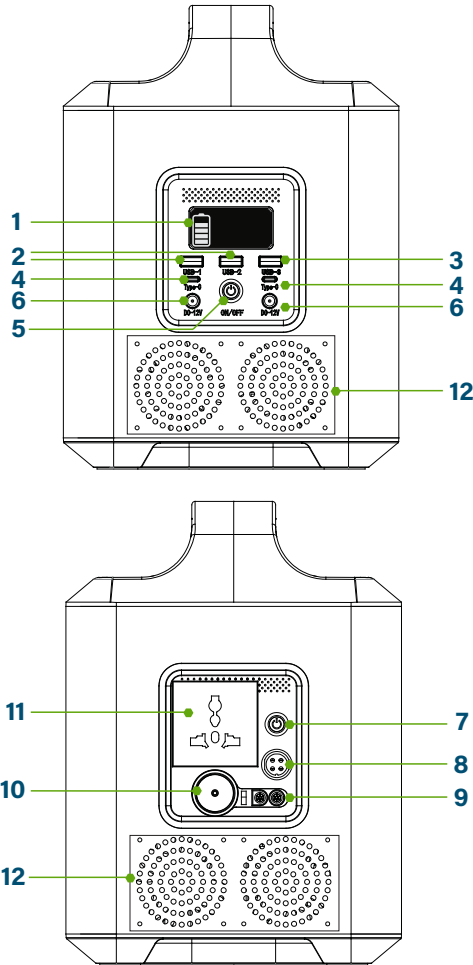

- 1. LCD Screen
- 2. USB Output Port
- 3. USB Quick Charge Output Port
- 4. Type C Output Port
- 5. DC Power Button
- 6. DC Output Port (12V7A)
- 7. AC Power Button
- 8. Input DC In Charger Port
- 9. Input/Output DC 30A Quick Port
- 10. Cigarette Lighter Output Socket (12V)
- 11. AC Output Socket (220/110V)
- 12. DC Fan Cooling Vent

## WHAT'S IN THE BOX

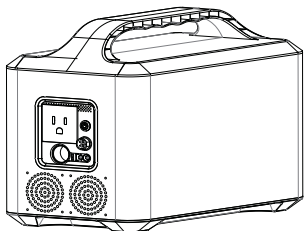

Outlaw 1072S

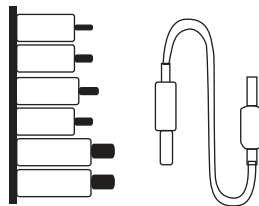

Adapters w/ DC Cable

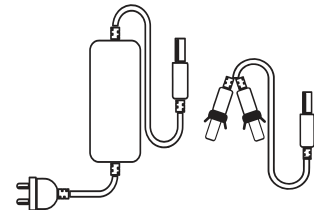

AC Charger /AC Cable & Solar (MC4) to DC Charger adapter

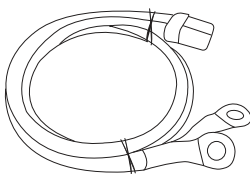

EC5 to Ring Terminal to access 30A quick charge/discharge port

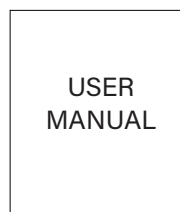

User Manual

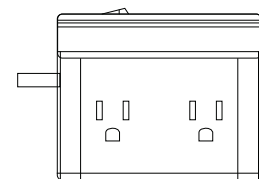

Power Strip

# LIMITED WARRANTY

The Manufacturer has no obligation under this Limited Warranty for Product subjected to the following conditions (including but not limited to):

Damage caused during shipping or mishandling of the Product

Damage due to improper installation; loose terminal connections, under-sized cabling, incorrect series (cannot be used in series) or parallel connections, reverse polarity connections or insufficient space for airflow

Environmental damage such as inappropriate storage conditions as defined by the Manufacturer, exposure to extreme hot or cold temperatures, fire or freezing, or water damage, impact or collision Damage due to improper operation or maintenance such as under- or over-charging the Product, cold temperature charging, lack of cleaning resulting in corroded terminal connections or build-up of dirt, debris, organic matter, fossil fuels or chemicals on the Product casing

Improper use of cables such as improper connections or not connecting them

Product that has been opened, modified or tampered with

Tampering or removal of manufacture date codes

Product that was used for applications other than which it was designed and intended for by the Manufacturer

Product that was under-sized for the application

This Limited Warranty does not cover a Product that has reached its normal end of life due to usage which may occur prior to the Warranty Period. A battery can deliver only a fixed amount of Energy over its life which will occur over different periods of time depending on the application.

The Manufacturer reserves the right to deny a warranty claim if the Product is determined, upon inspection, to be at its normal end of life even if within the Warranty Period.

For full warranty information please visit <https://relionbattery.com/resource-center/warranty>



This device complies with part 15 of the FCC Rules. Operation is subject to the following two conditions:

1. This device may not cause harmful interference
2. This device must accept any interference received, including interference that may cause undesired operation.



855.931.2466 • [relionbattery.com](https://relionbattery.com)

